



US00D755759S

(12) **United States Design Patent**
Cai

(10) **Patent No.:** **US D755,759 S**

(45) **Date of Patent:** **** May 10, 2016**

(54) **IN-EAR HEADPHONE**

(71) Applicant: **Hejin Cai**, Guangdong (CN)

(72) Inventor: **Hejin Cai**, Guangdong (CN)

(**) Term: **14 Years**

(21) Appl. No.: **29/520,178**

(22) Filed: **Mar. 11, 2015**

(30) **Foreign Application Priority Data**

Nov. 14, 2014 (CN) 2014 3 0447476

(51) **LOC (10) Cl.** **14-01**

(52) **U.S. Cl.**
USPC **D14/223**

(58) **Field of Classification Search**
USPC D14/223; 181/129, 130, 135; 379/430,
379/431; 381/380, 381; 455/90.3, 575.1
CPC H04R 1/10
See application file for complete search history.

(56) **References Cited**

U.S. PATENT DOCUMENTS

- D278,234 S * 4/1985 Saito D14/205
- D337,118 S * 7/1993 Seikita D14/223
- D340,932 S * 11/1993 Yan D14/249
- 5,420,935 A * 5/1995 Shinohara H04R 1/1016
379/431
- D431,553 S * 10/2000 Suzuki D14/223
- 6,574,345 B1 * 6/2003 Huang H04R 1/1016
379/430
- 6,668,064 B1 * 12/2003 Lin H04R 1/1016
381/328
- D485,548 S * 1/2004 Obata D14/223
- D487,077 S * 2/2004 Obata D14/223
- 6,731,772 B1 * 5/2004 Byun H04R 1/12
181/130
- D499,397 S * 12/2004 Hlas D14/223
- D515,070 S * 2/2006 Andre D14/205
- D523,846 S * 6/2006 Lee D14/205
- D557,689 S * 12/2007 Huang D14/223
- D578,517 S * 10/2008 Pausch D14/223

- D579,005 S * 10/2008 Wilhelmsen D14/223
- D586,332 S * 2/2009 Ewert D14/223
- D593,537 S * 6/2009 Arimoto D14/205
- D626,948 S * 11/2010 Nault D14/223
- D627,766 S * 11/2010 Arimoto D14/223
- D628,193 S * 11/2010 Zheng D14/223
- D629,793 S * 12/2010 Goransson D14/223
- D633,086 S * 2/2011 Chen D14/223
- D641,738 S * 7/2011 Perez D14/223
- 8,077,898 B2 * 12/2011 Huang H04R 1/1016
381/186
- D653,235 S * 1/2012 McManigal D14/205
- D656,481 S * 3/2012 McManigal D14/205
- D657,780 S * 4/2012 Dahlberg D14/223
- D662,493 S * 6/2012 Chen D14/223
- D664,523 S * 7/2012 Naitou D14/223
- D669,058 S * 10/2012 Lee D14/223
- D674,781 S * 1/2013 Sakata D14/223
- D676,427 S * 2/2013 Yang D14/223
- 8,391,536 B2 * 3/2013 Hashimoto H04R 1/1016
381/370
- D681,015 S * 4/2013 Akana D14/223
- D687,418 S * 8/2013 Godfrey D14/223
- D695,718 S * 12/2013 Burgett D14/223
- D696,230 S * 12/2013 Burgett D14/223
- D711,857 S * 8/2014 Burgett D14/223
- D718,284 S * 11/2014 Shibusawa D14/223
- D718,285 S * 11/2014 Shibusawa D14/223
- D725,634 S * 3/2015 Burgett D14/223
- D732,508 S * 6/2015 Funayama D14/223

(Continued)

Primary Examiner — Paula Greene

(57) **CLAIM**

The ornamental design for an in-ear headphone, as shown.

DESCRIPTION

FIG. 1 is a front elevational view of an in-ear headphone showing my new design;
 FIG. 2 is a rear elevational view thereof;
 FIG. 3 is a left side view thereof;
 FIG. 4 is a right side view thereof;
 FIG. 5 is a top plan view thereof;
 FIG. 6 is a bottom plan view thereof; and,
 FIG. 7 is a perspective view thereof.

1 Claim, 2 Drawing Sheets

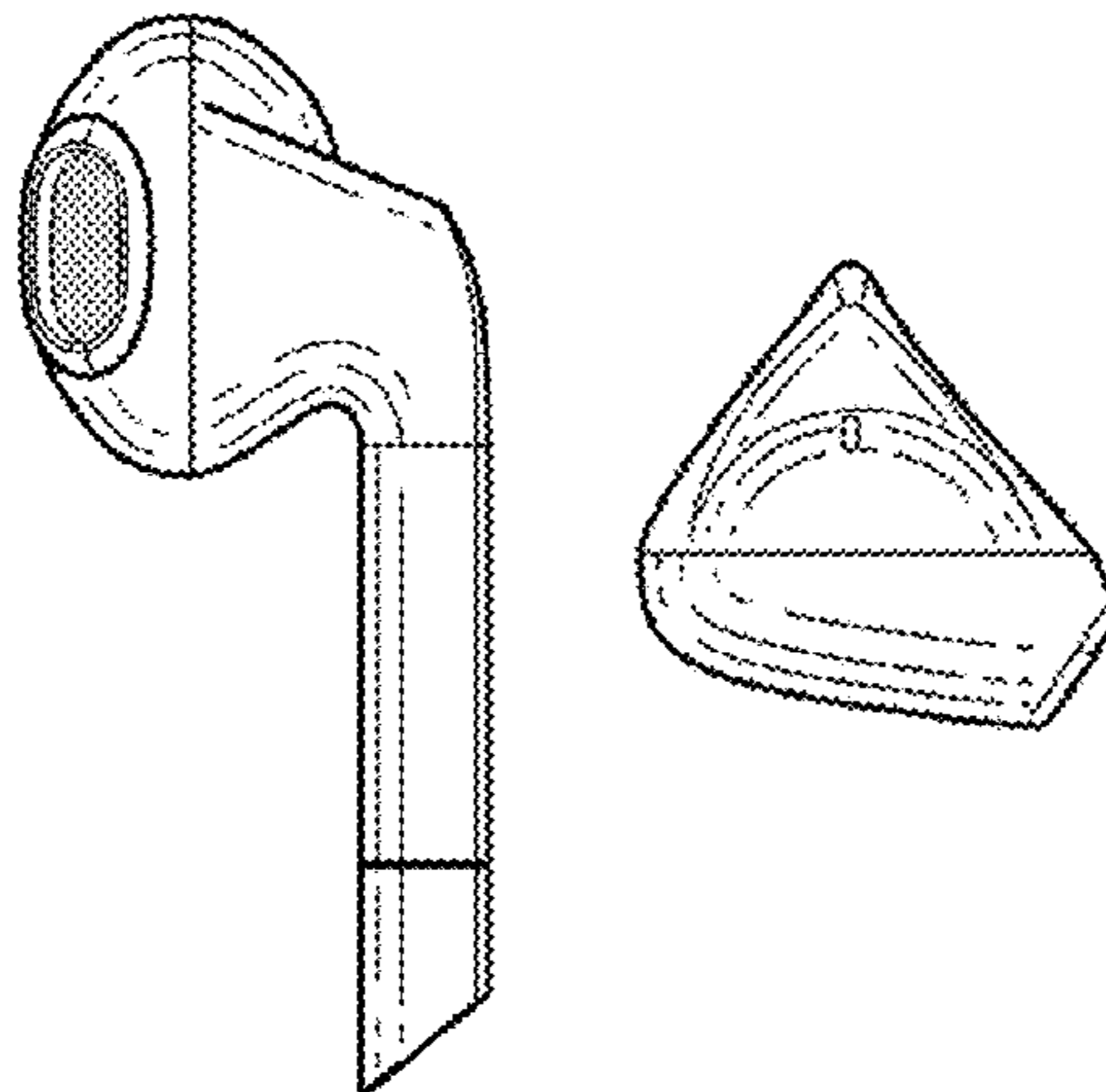

(56)

References Cited

U.S. PATENT DOCUMENTS

D733,101 S * 6/2015 Pi D14/223
D733,689 S * 7/2015 Narita D14/223
D738,864 S * 9/2015 Lee D14/223
D741,287 S * 10/2015 Harata D14/205

D746,268 S * 12/2015 Karayiannis D14/223
2012/0237074 A1* 9/2012 Aase H04R 1/1016
381/380
2013/0004011 A1* 1/2013 Hayashida H04R 1/1016
381/380
2013/0343595 A1* 12/2013 Zorkendorfer H04R 1/10
381/380

* cited by examiner

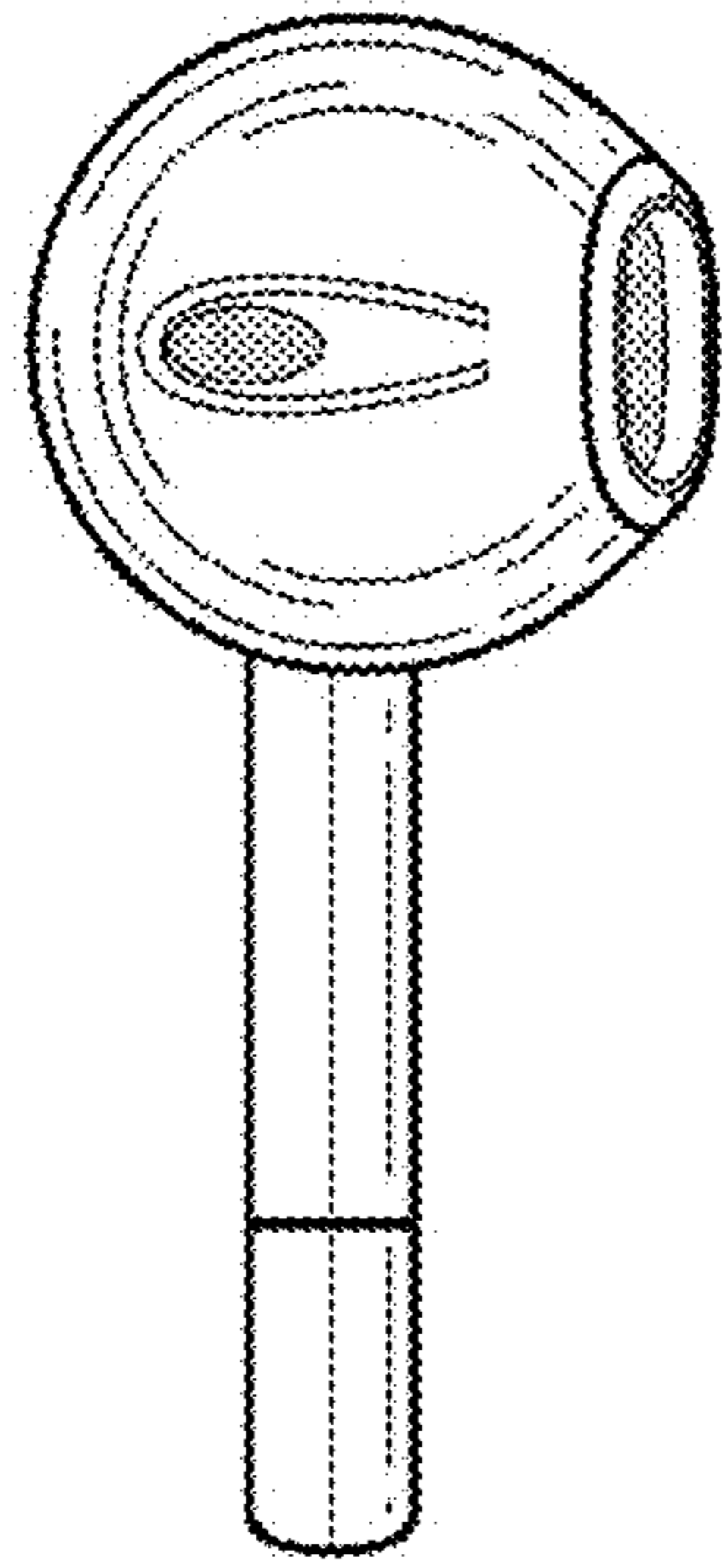

FIG. 1

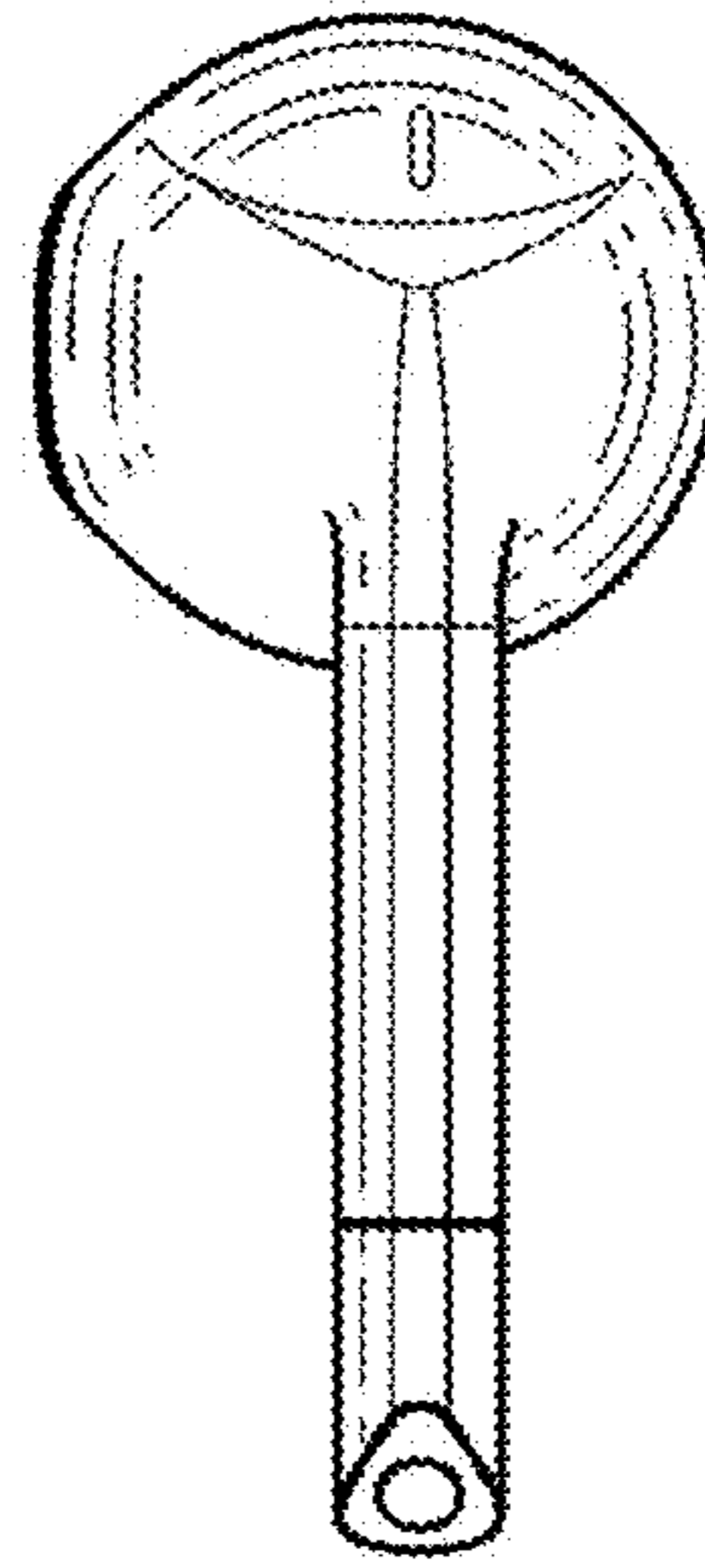

FIG. 2

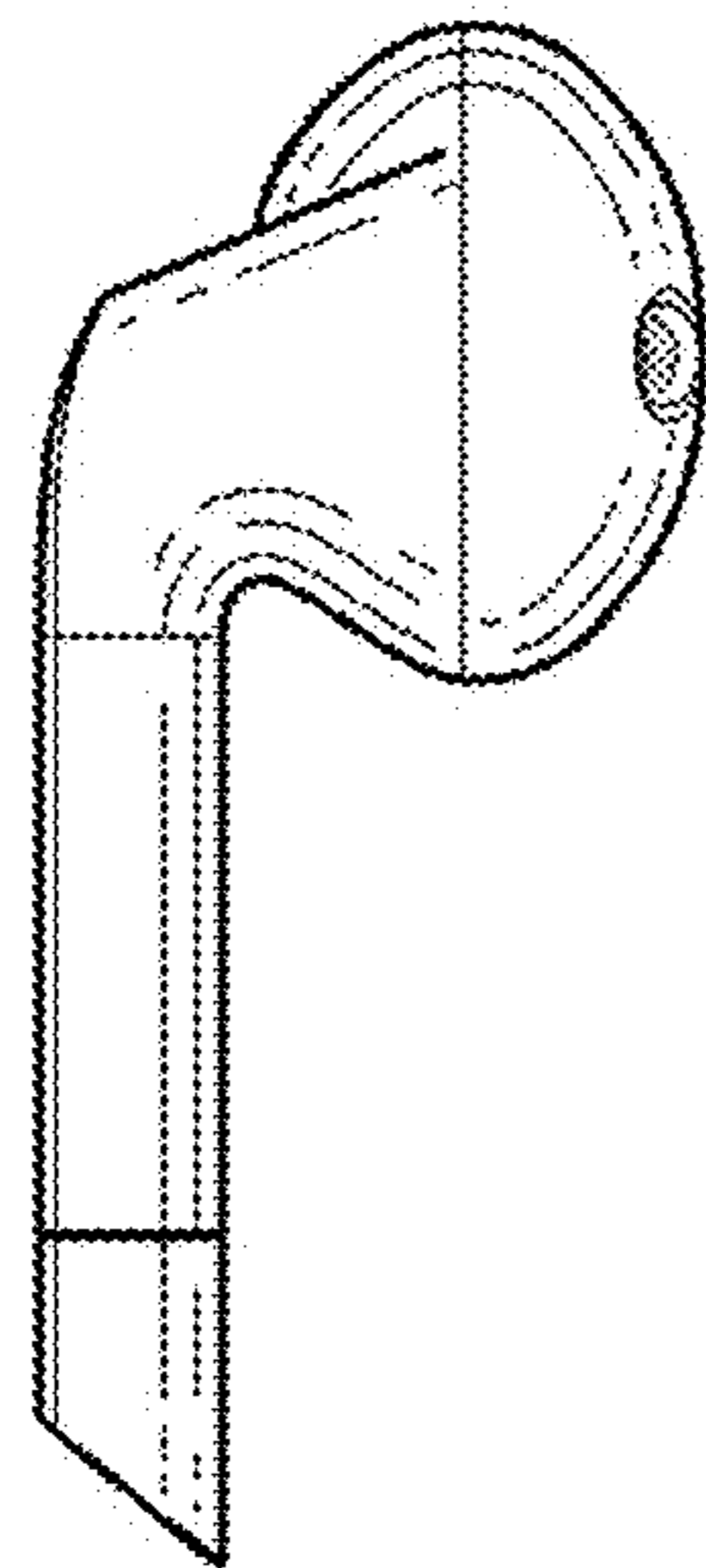

FIG. 3

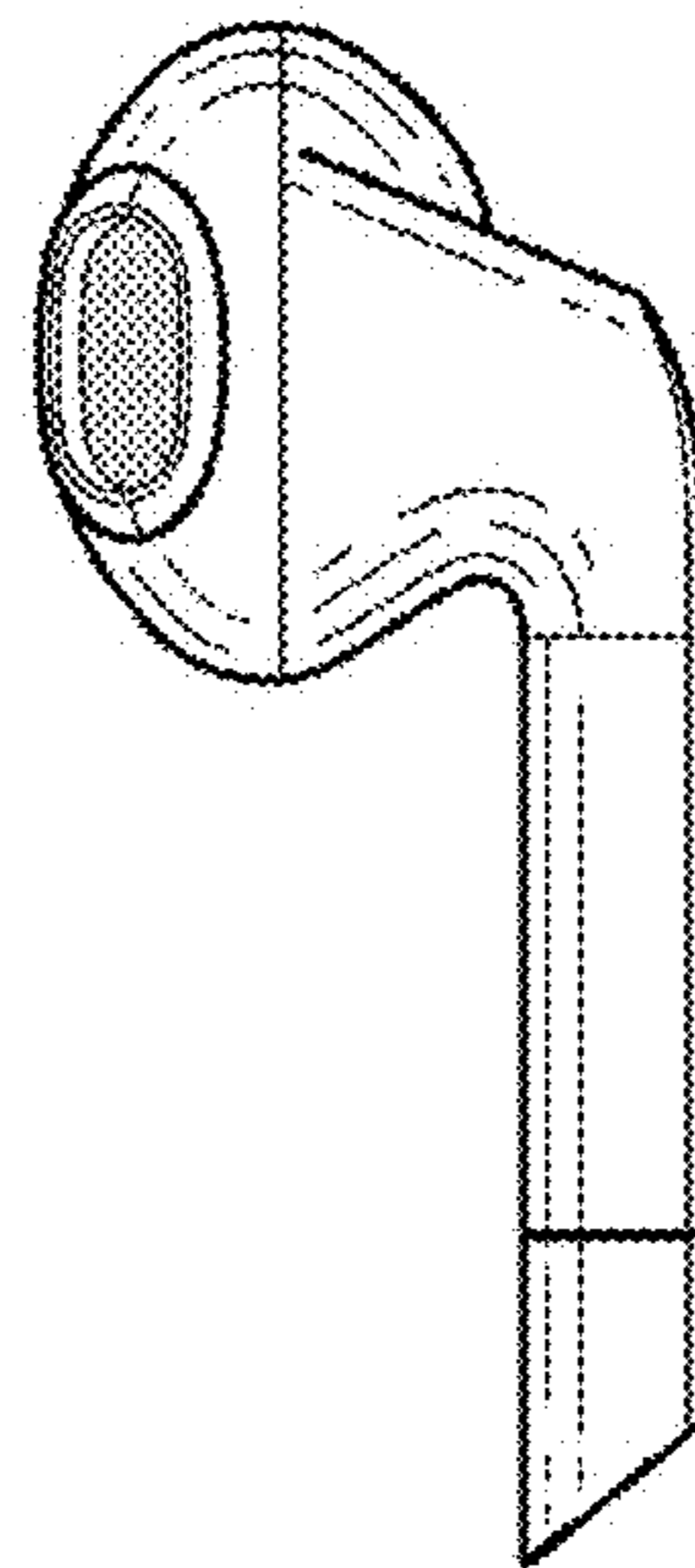

FIG. 4

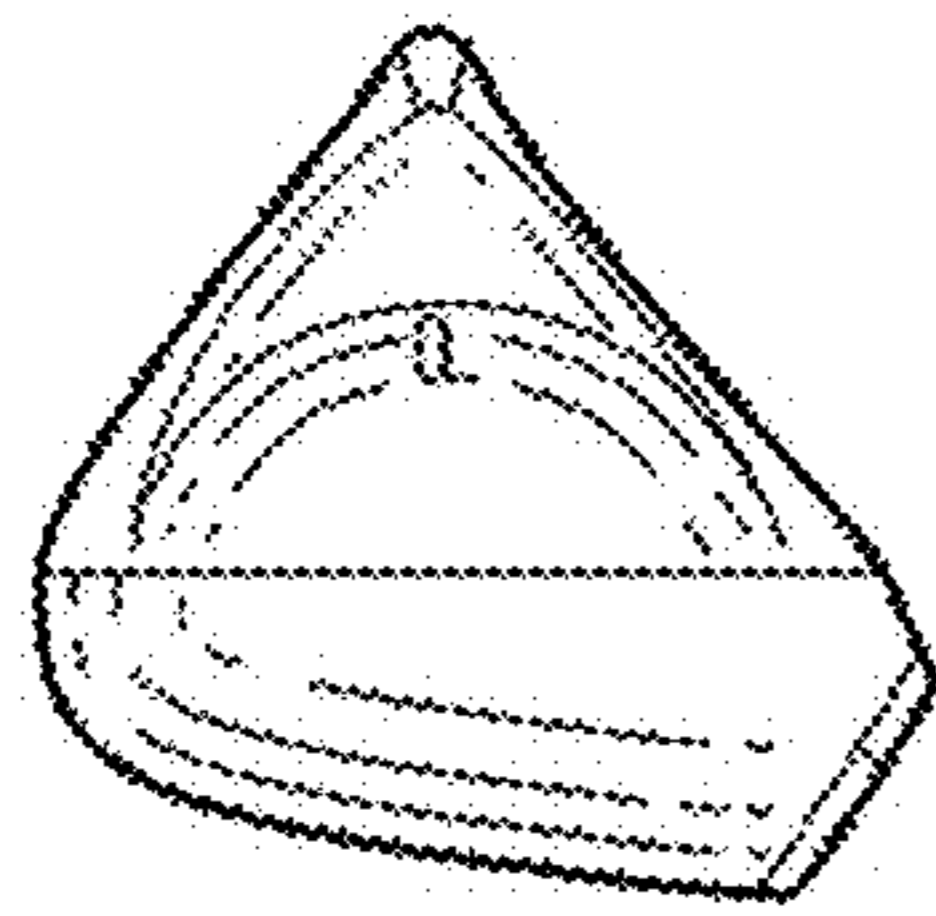

FIG. 5

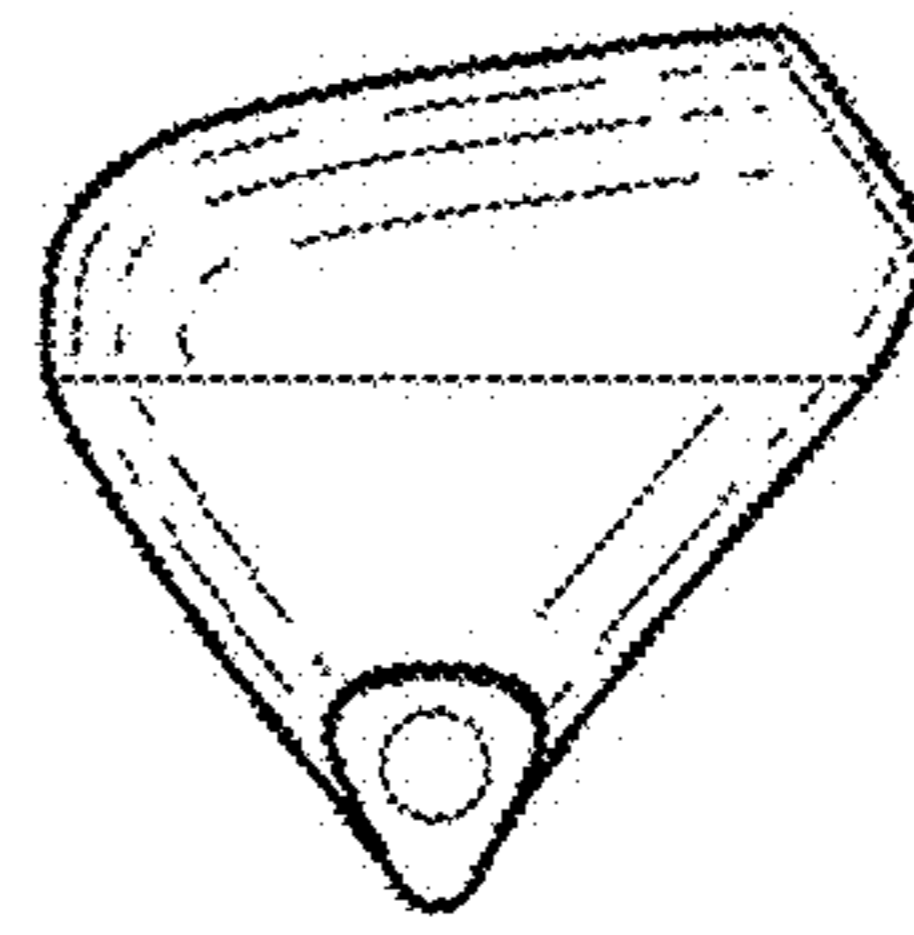

FIG. 6

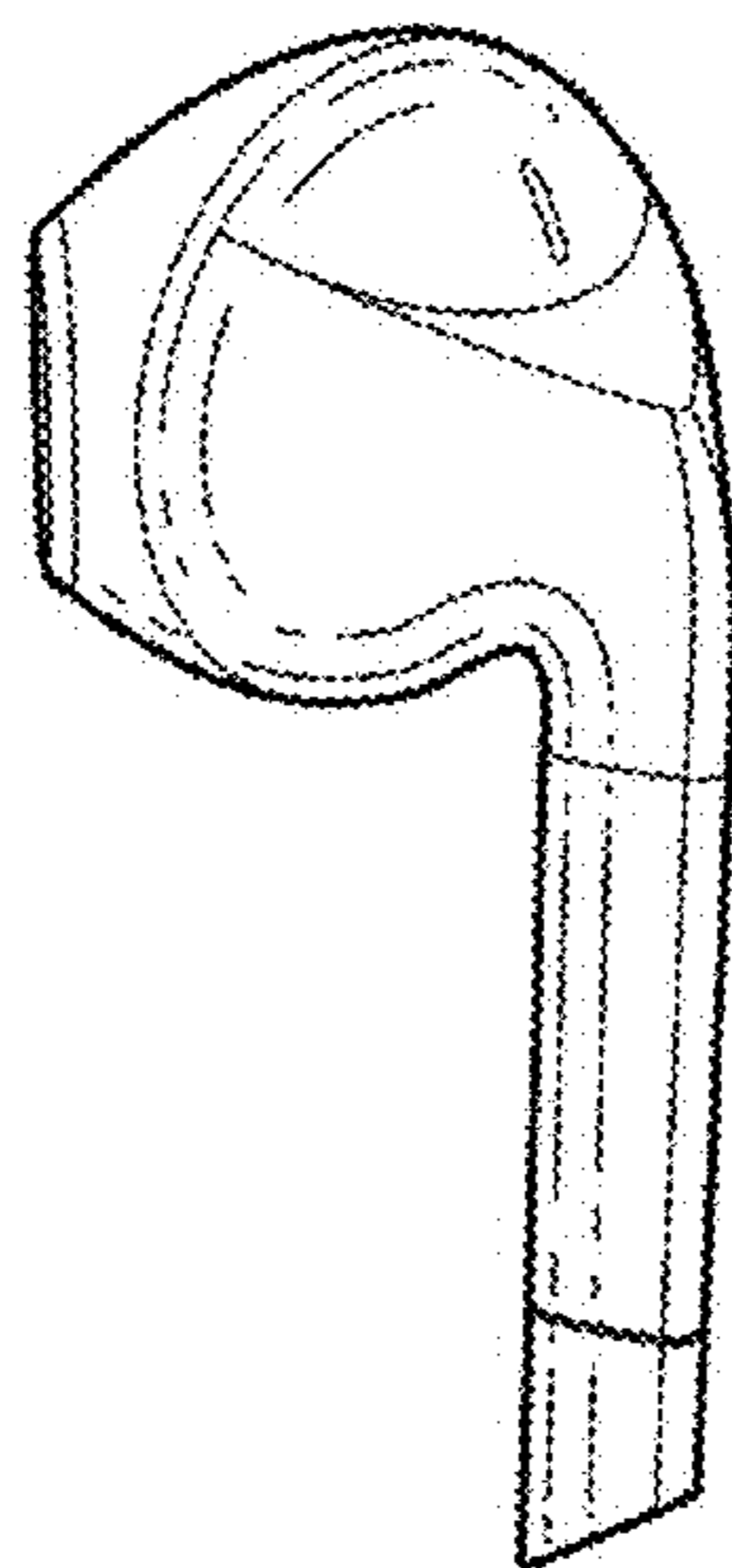

FIG. 7