



US00D755706S

(12) **United States Design Patent**  
**Roach et al.**

(10) **Patent No.:** **US D755,706 S**  
(45) **Date of Patent:** **\*\* May 10, 2016**

(54) **STORAGE CONTAINER FOR USE WITH A VEHICLE**

(71) Applicants: **Robert Roach**, Holt, MI (US); **Craig Wieland**, Mason, MI (US)

(72) Inventors: **Robert Roach**, Holt, MI (US); **Craig Wieland**, Mason, MI (US)

(\*\*) Term: **14 Years**

(21) Appl. No.: **29/510,387**

(22) Filed: **Nov. 26, 2014**

**Related U.S. Application Data**

(63) Continuation of application No. 29/449,629, filed on Mar. 15, 2013, now Pat. No. Des. 722,009.

(51) **LOC (10) CL.** ..... **12-99**

(52) **U.S. CL.**  
USPC ..... **D12/414.1**

(58) **Field of Classification Search**  
USPC ..... D12/414.1, 414, 413, 412, 221, 406, D12/157, 423, 414.4; D6/552, 317-319, D6/513-514, 304-306; D32/304-306, 35, D32/58  
CPC ..... B60R 7/02; B60R 9/065; Y10S 224/925  
See application file for complete search history.

(56) **References Cited**

**U.S. PATENT DOCUMENTS**

954,918 A	4/1910	Biro
1,444,487 A	2/1923	Volters
1,449,419 A	3/1923	Kraus
1,489,527 A	4/1924	Henry
2,529,983 A	11/1950	White
4,230,227 A	10/1980	Kowall et al.
4,260,091 A	4/1981	French et al.
D274,139 S	6/1984	Suffern et al.

(Continued)

**OTHER PUBLICATIONS**

United States Patent and Trademark Office, "Office Action", issued in connection with U.S. Appl. No. 13/447,163, mailed on Apr. 1, 2013, 17 Pages.

(Continued)

*Primary Examiner* — Katrina A Betton

(74) *Attorney, Agent, or Firm* — Hanley, Flight & Zimmerman, LLC

(57) **CLAIM**

The ornamental design for a storage container for use with a vehicle, as shown and described.

**DESCRIPTION**

FIG. 1 is an isometric view of a storage container for use with a vehicle in an erected configuration.

FIG. 2 is a side view of the storage container for use with a vehicle of FIG. 1 in the erected configuration.

FIG. 3 is another side view of the storage container for use with a vehicle of FIG. 1 in the erected configuration.

FIG. 4 is another side view of the storage container for use with a vehicle of FIG. 1 in the erected configuration.

FIG. 5 is another side view of the storage container for use with a vehicle of FIG. 1 in the erected configuration.

FIG. 6 is a top plan view of the storage container for use with a vehicle of FIG. 1 in the erected configuration.

FIG. 7 is a bottom plan view of the storage container for use with a vehicle of FIG. 1 in the erected configuration; and,

FIG. 8 is another isometric view of the storage container for use with a vehicle of FIG. 1 in the erected configuration.

The features shown in broken lines are for illustrative purposes only and do not form part of the claimed design.

**1 Claim, 7 Drawing Sheets**

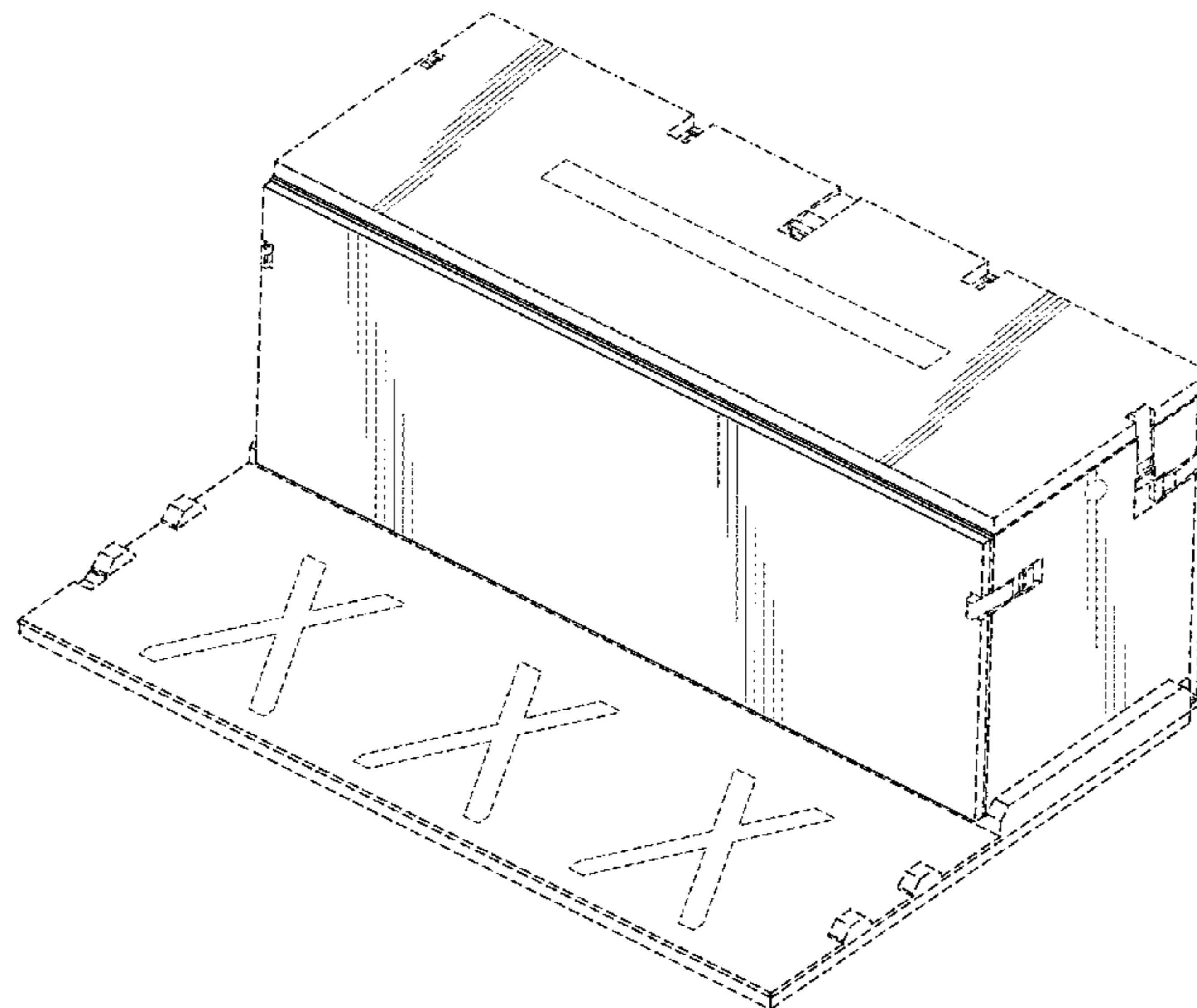

(56)

References Cited

U.S. PATENT DOCUMENTS

4,673,087 A 6/1987 Webb  
 4,828,312 A 5/1989 Kinkel et al.  
 4,875,730 A 10/1989 Justice  
 5,226,302 A 7/1993 Anderson  
 5,299,704 A 4/1994 Thorby  
 5,341,950 A 8/1994 Sinz  
 5,368,210 A 11/1994 Wotring  
 5,456,514 A 10/1995 Justice  
 5,478,130 A 12/1995 Matulin et al.  
 5,782,372 A 7/1998 Weiss et al.  
 5,853,116 A 12/1998 Schreiner  
 5,862,932 A 1/1999 Walsh et al.  
 5,875,912 A 3/1999 Hobson  
 6,015,178 A 1/2000 Haack  
 6,070,775 A 6/2000 Tolley et al.  
 D430,103 S 8/2000 Scudder  
 6,254,162 B1 7/2001 Faber et al.  
 6,267,427 B1 7/2001 Ziehl  
 6,308,873 B1 10/2001 Baldas et al.  
 6,401,995 B1 6/2002 Yuille et al.  
 6,454,148 B1 9/2002 Cook  
 6,464,276 B1 10/2002 Gruich  
 6,507,701 B2 1/2003 Lake  
 6,536,826 B1 3/2003 Reed  
 6,644,710 B2 \* 11/2003 Seel ..... B60R 7/02  
 224/497  
 6,749,077 B1 6/2004 McAlpine et al.  
 6,827,385 B2 12/2004 Mobley  
 6,932,404 B2 8/2005 Vejnar  
 6,938,807 B2 9/2005 Victor  
 6,986,541 B1 1/2006 Haack  
 7,097,224 B2 8/2006 Lester et al.  
 7,290,820 B1 11/2007 Smith et al.  
 D658,373 S \* 5/2012 Gros ..... D12/414.1  
 D659,632 S 5/2012 Jordan  
 D660,781 S \* 5/2012 Ruffino ..... D12/414.1  
 8,215,693 B2 7/2012 Ulita  
 8,701,950 B2 4/2014 Roach et al.  
 D722,009 S \* 2/2015 Roach ..... D12/414.1  
 8,960,756 B2 2/2015 Roach et al.  
 2001/0017474 A1 8/2001 Leitner et al.  
 2002/0175530 A1 11/2002 Lake  
 2003/0085584 A1 5/2003 Golden  
 2003/0098591 A1 5/2003 Leitner et al.  
 2004/0232016 A1 11/2004 Dietrich  
 2005/0242138 A1 11/2005 Warganich  
 2006/0266778 A1 11/2006 Allotey  
 2007/0119093 A1 5/2007 Jaskulski  
 2008/0264946 A1 10/2008 Moschella et al.  
 2009/0056592 A1 3/2009 Threet et al.  
 2009/0189404 A1 7/2009 Anderson et al.  
 2009/0255967 A1 10/2009 Lueder  
 2009/0321434 A1 \* 12/2009 Rothschild ..... A45C 7/0036  
 220/6  
 2010/0140973 A1 6/2010 Duncan  
 2010/0264180 A1 10/2010 Allotey  
 2010/0270821 A1 \* 10/2010 Ulita ..... B60R 7/02  
 296/37.14  
 2010/0320793 A1 \* 12/2010 Aebker ..... B60R 5/04  
 296/37.13  
 2012/0181810 A1 7/2012 Alvarino  
 2012/0261451 A1 10/2012 Roach et al.

2012/0261452 A1 10/2012 Roach et al.  
 2012/0261938 A1 10/2012 Roach et al.  
 2014/0062042 A1 \* 3/2014 Wagner ..... A45C 11/20  
 280/30  
 2014/0175137 A1 6/2014 Roach et al.  
 2014/0326764 A1 \* 11/2014 Roach ..... B60R 9/065  
 224/404  
 2014/0346205 A1 11/2014 Roach et al.

OTHER PUBLICATIONS

United States Patent and Trademark Office, "Final Office Action", issued in connection with U.S. Appl. No. 13/447,163, mailed on Jul. 18, 2013, 21 Pages.  
 United States Patent and Trademark Office, "Advisory Action", issued in connection with U.S. Appl. No. 13/447,163, mailed on Oct. 10, 2013, 3 Pages.  
 United States Patent and Trademark Office, "Office Action", issued in connection with U.S. Appl. No. 13/087,140, mailed on Dec. 28, 2012, 13 Pages.  
 United States Patent and Trademark Office, "Final Office Action", issued in connection with U.S. Appl. No. 13/087,140, mailed on Apr. 25, 2013, 19 Pages.  
 United States Patent and Trademark Office, "Office Action", issued in connection with U.S. Appl. No. 13/446,447, mailed on Aug. 6, 2013, 12 Pages.  
 United States Patent and Trademark Office, "Notice of Allowance", issued in connection with U.S. Appl. No. 13/447,163, mailed on Feb. 3, 2014, 58 Pages.  
 United States Patent and Trademark Office, "Office Action", issued in connection with U.S. Appl. No. 13/446,447, mailed on Mar. 18, 2014, 14 Pages.  
 United States Patent and Trademark Office, "Final Office Action", issued in connection with U.S. Appl. No. 13/446,447, mailed on Nov. 21, 2013, 8 Pages.  
 United States Patent and Trademark Office, "Restriction", issued in connection with U.S. Appl. No. 13/446,447, mailed on Apr. 16, 2013, 6 Pages.  
 United States Patent and Trademark Office, "Notice of Allowance", issued in connection with U.S. Appl. No. 29/449,629, mailed on Sep. 12, 2014, 29 pages.  
 United States Patent and Trademark Office, "Final Office Action", issued in connection with U.S. Appl. No. 13/446,447, mailed on Jul. 9, 2014, 10 pages.  
 Canadian Intellectual Property Office, "Examiner's Report", issued in connection with Canadian Patent Application No. 152911, issued on Jul. 16, 2014, 1 page.  
 United States Patent and Trademark Office, "Notice of Allowance", issued in connection with U.S. Appl. No. 13/446,447, mailed on Nov. 13, 2014, 15 pages.  
 United States Patent and Trademark Office, "Office Action," issued in connection with U.S. Appl. No. 14/076,926, mailed on Mar. 12, 2015, 88 pages.  
 United States Patent and Trademark Office, "Notice of Allowance", issued in connection with U.S. Appl. No. 29/511,735, mailed on Jan. 13, 2016, 40 pages.  
 United States Patent and Trademark Office, "Notice of Allowance", issued in connection with U.S. Appl. No. 29/510,390, mailed on Jan. 12, 2016, 40 pages.

\* cited by examiner



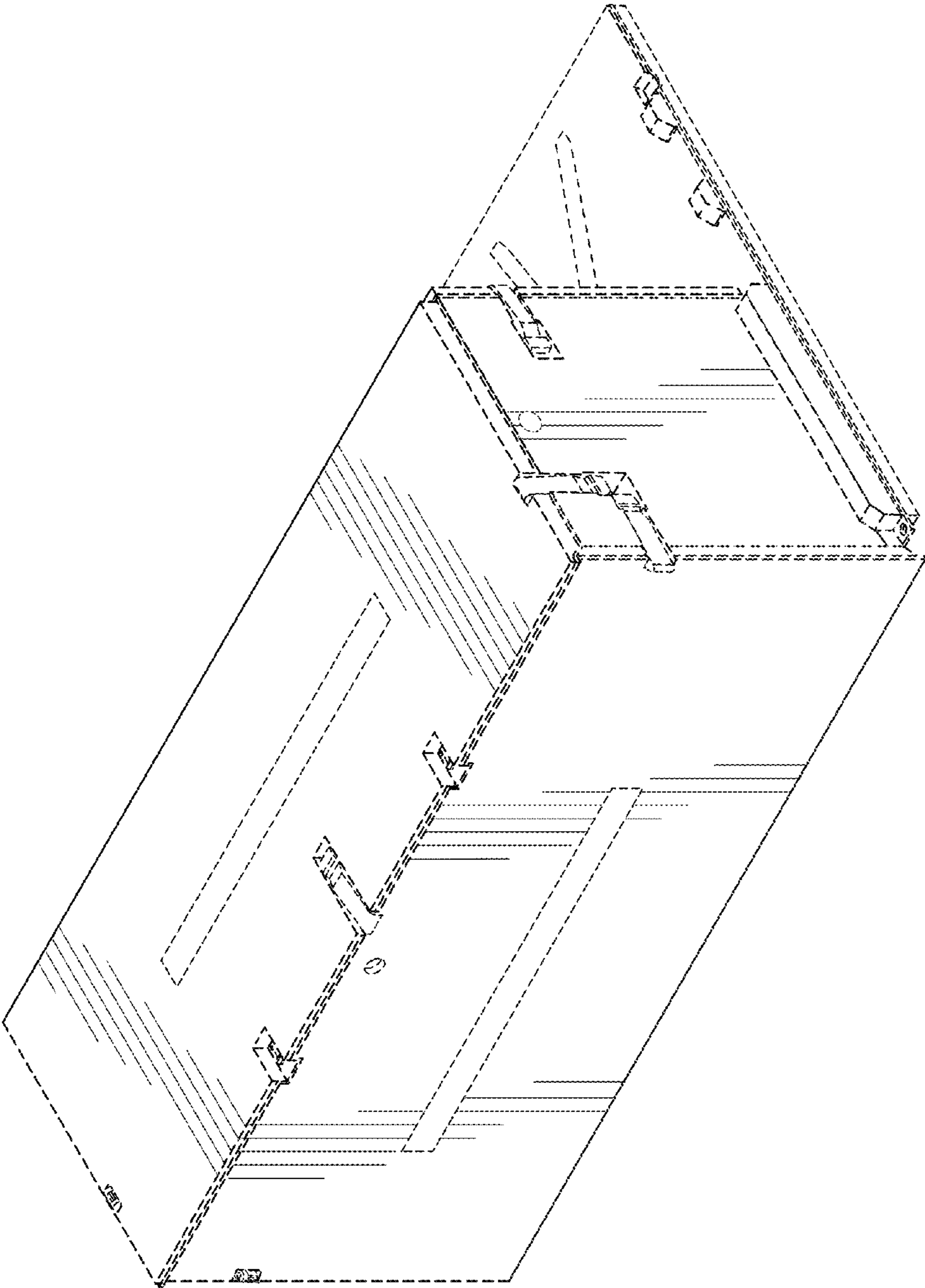

FIG. 1

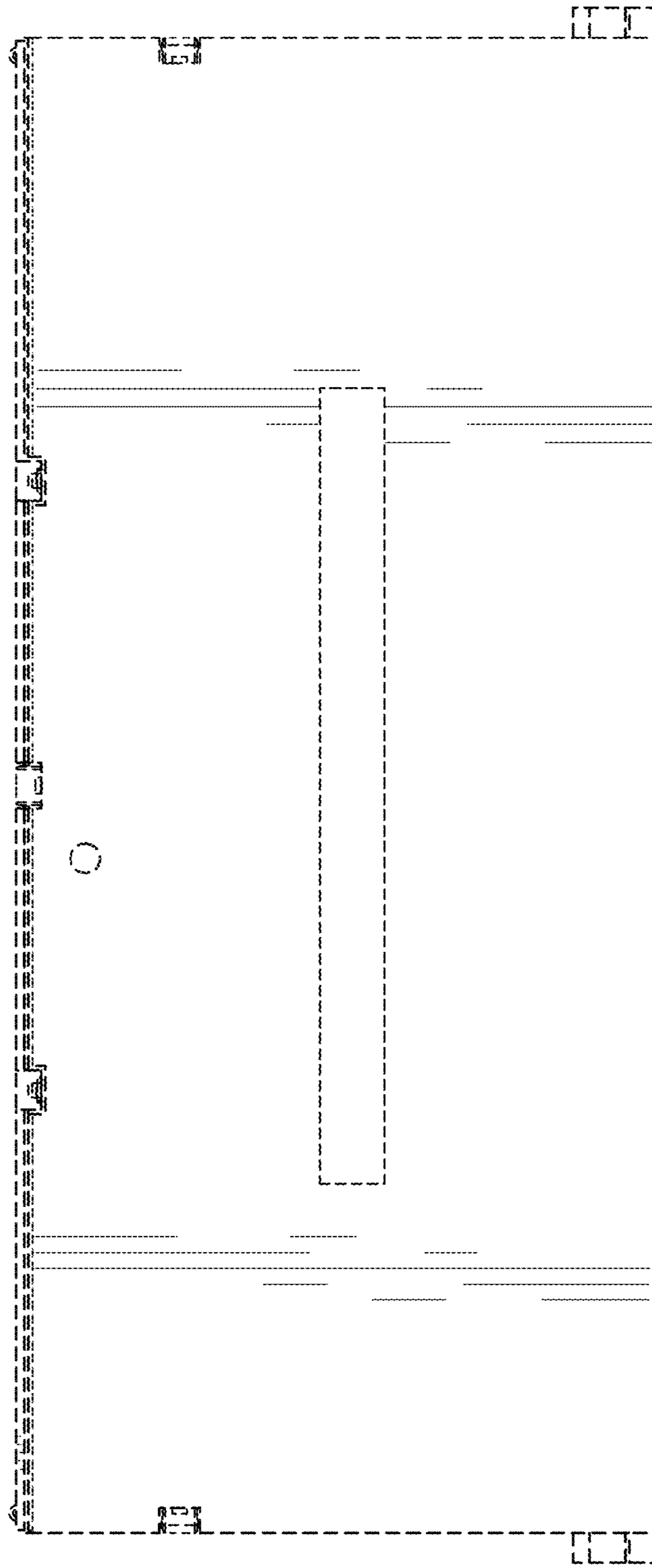

FIG. 2

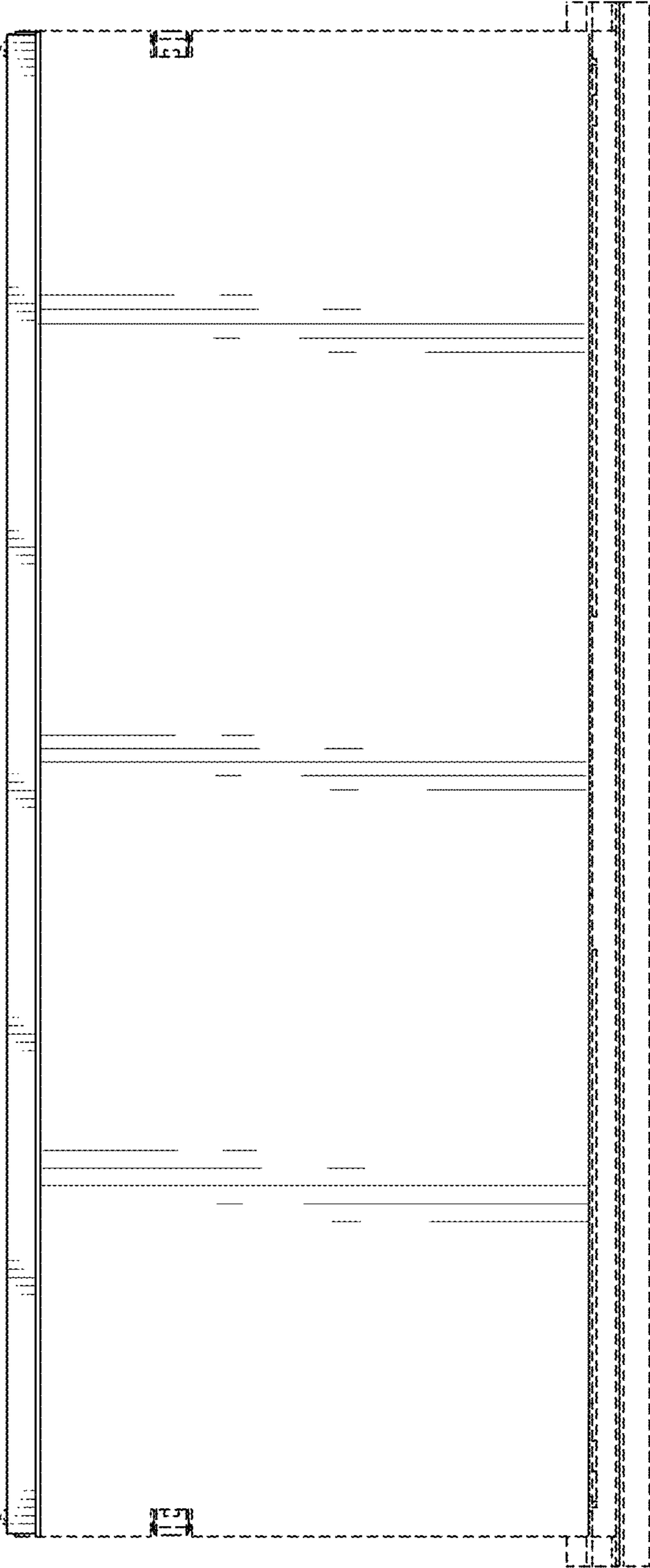

FIG. 3

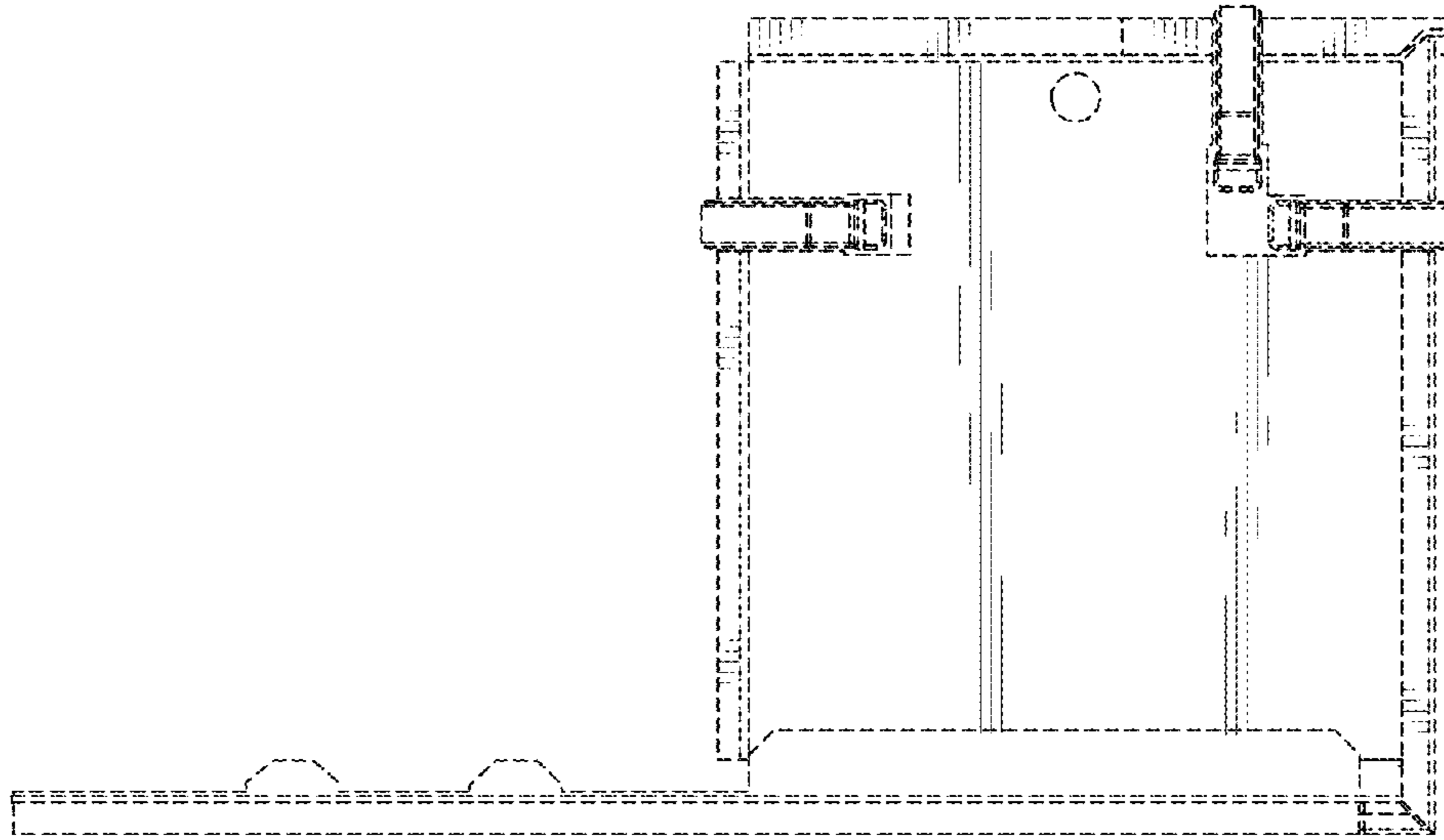

FIG. 4

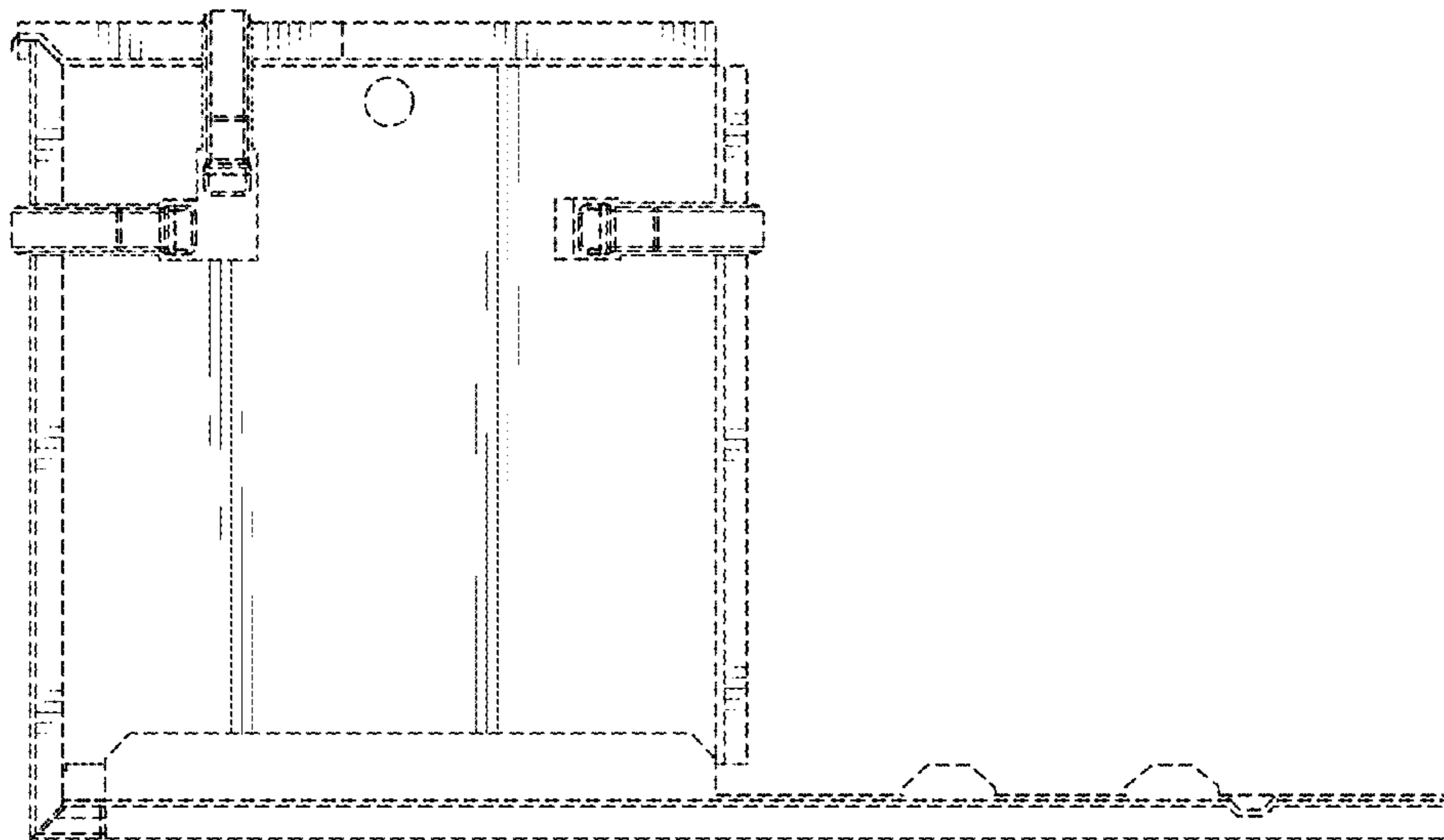

FIG. 5

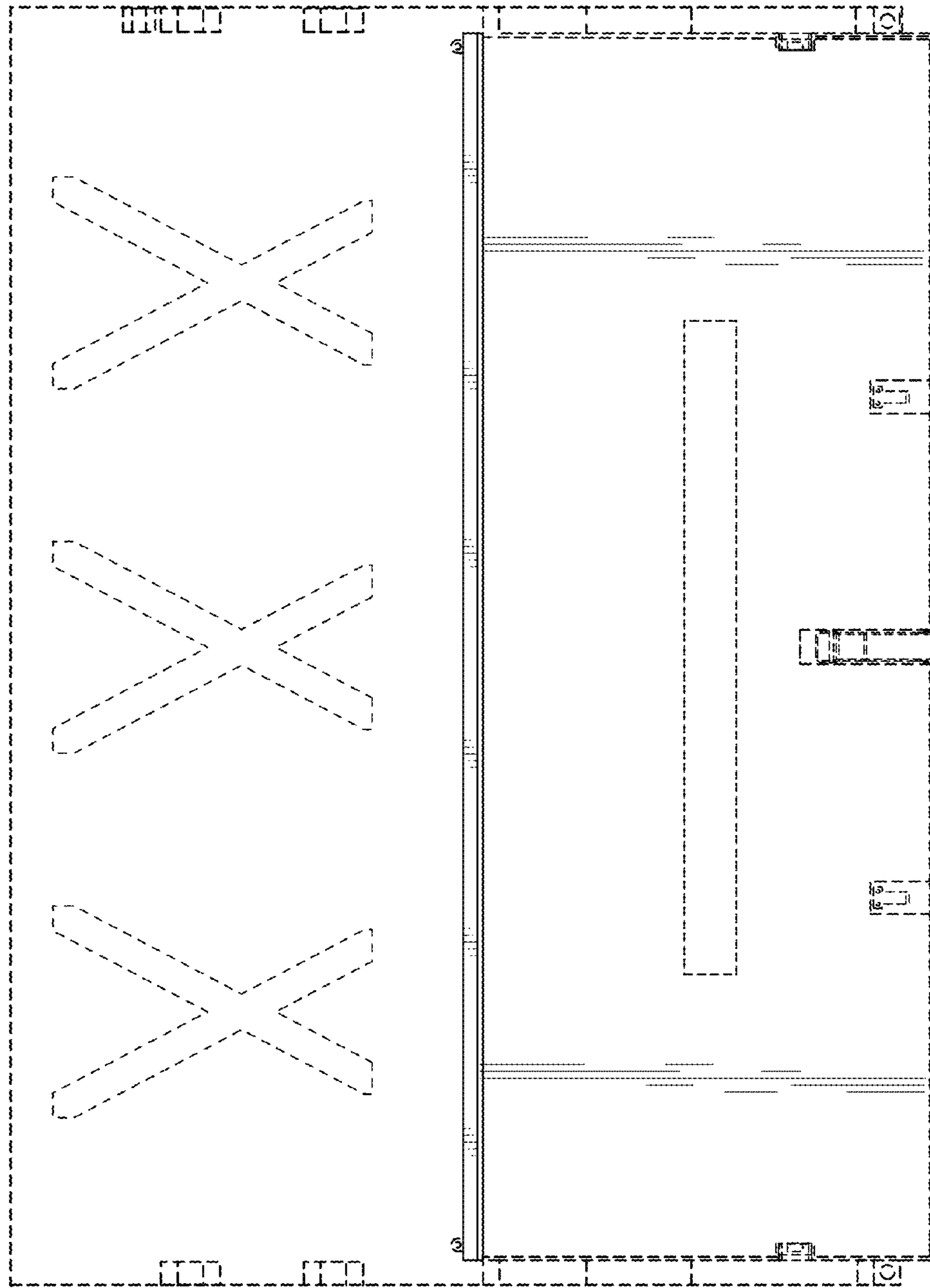

FIG. 6

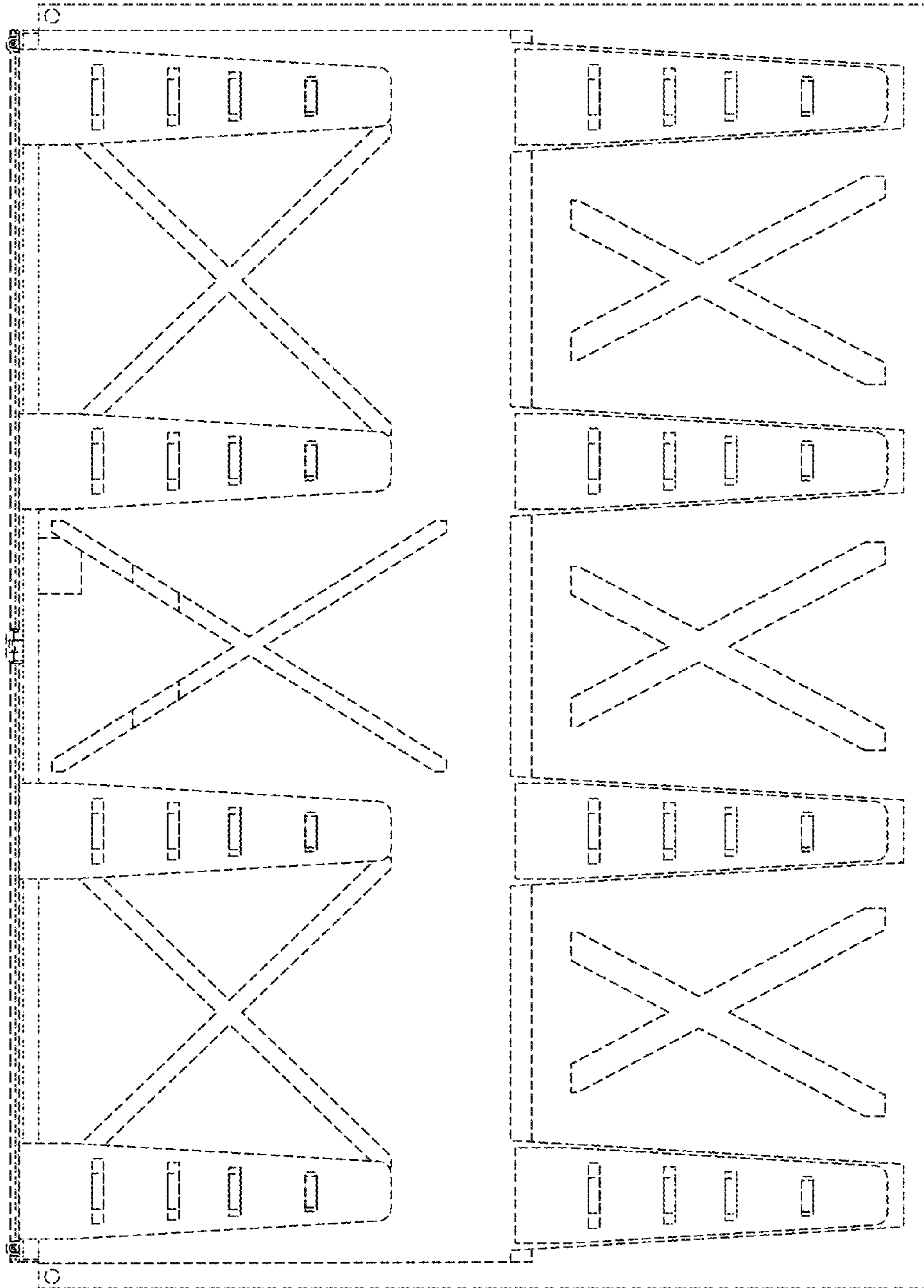

FIG. 7



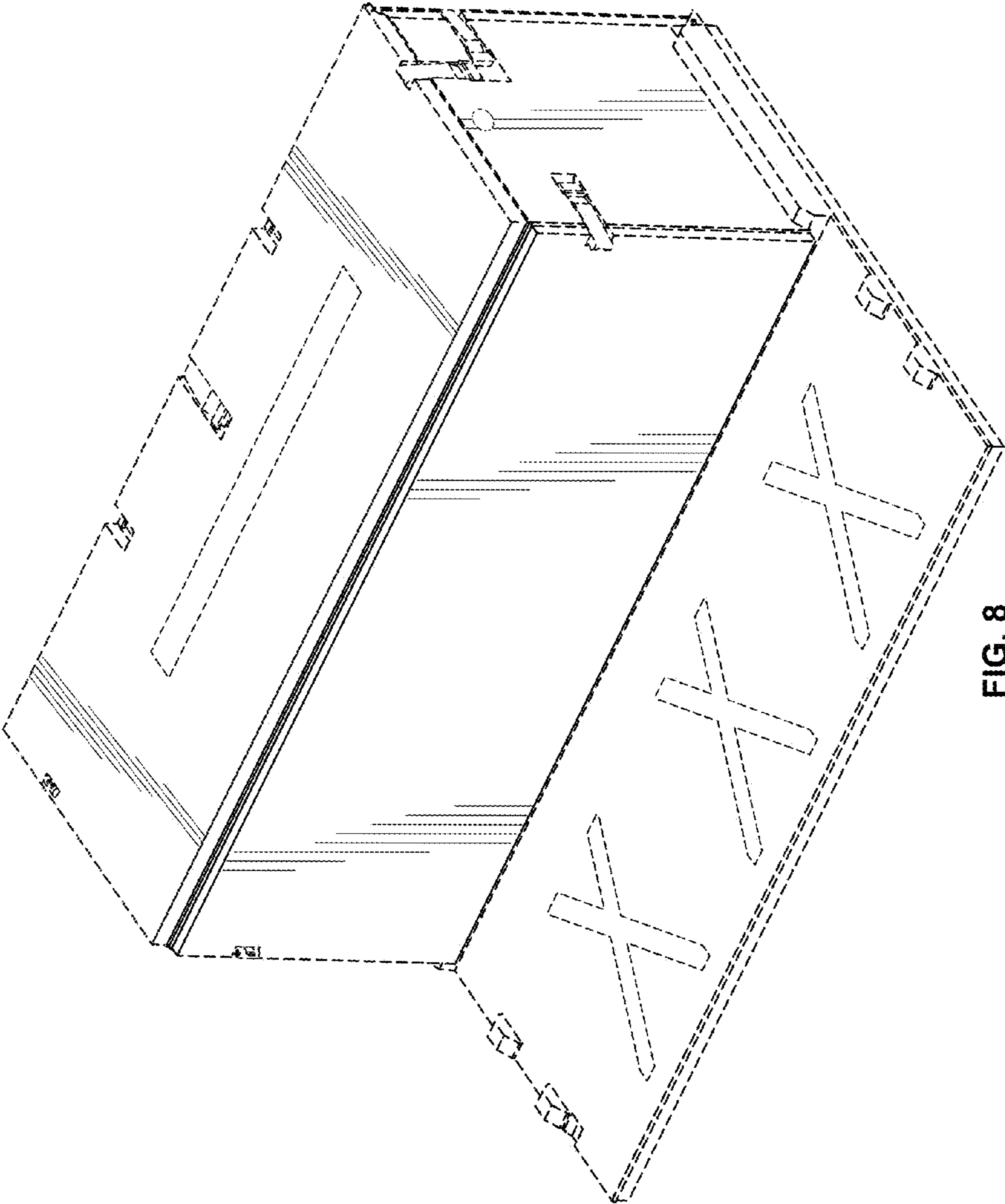

FIG. 8