



US00D755658S

(12) **United States Design Patent**  
**Daba**

(10) **Patent No.:** **US D755,658 S**  
(45) **Date of Patent:** **\*\* May 10, 2016**

(54) **FUNERAL TRAFFIC LIGHTED SIGN**  
(71) Applicant: **Anteneh Daba**, Silver Spring, MD (US)  
(72) Inventor: **Anteneh Daba**, Silver Spring, MD (US)  
(\*\*) Term: **14 Years**

(21) Appl. No.: **29/507,234**

(22) Filed: **Oct. 24, 2014**

(51) **LOC (10) Cl.** ..... **10-05**

(52) **U.S. Cl.**  
USPC ..... **D10/109.1**

(58) **Field of Classification Search**  
USPC ..... D10/109.1, 113.4; D20/39, 40, 42  
CPC ..... G09F 1/00  
See application file for complete search history.

(56) **References Cited**

**U.S. PATENT DOCUMENTS**

2,546,855	A	3/1951	Frame	
3,148,856	A	9/1964	Orlando	
3,955,786	A	5/1976	Duddy	
D397,364	S *	8/1998	Barrett	..... D10/109.1
D410,208	S	5/1999	Fowler	

D410,401	S	6/1999	Fowler	
5,913,616	A	6/1999	Galella	
D412,863	S *	8/1999	Barnes	..... D10/109.1
6,082,880	A	7/2000	Nerlino et al.	
6,559,001	B2	5/2003	Athavale et al.	
D490,474	S *	5/2004	Gibson	..... D20/10
D661,744	S *	6/2012	Lewis	..... D20/40
2006/0146554	A1	7/2006	Bauer	

\* cited by examiner

*Primary Examiner* — George D Kirschbaum

(57) **CLAIM**

The ornamental design for a funeral traffic lighted sign, as shown and described.

**DESCRIPTION**

FIG. 1 is a front view of a funeral traffic lighted sign showing my new design;  
FIG. 2 is a rear view of the funeral traffic lighted sign;  
FIG. 3 is a left side view of the funeral traffic lighted sign;  
FIG. 4 is a right side view of the funeral traffic lighted sign;  
FIG. 5 is a top view of the funeral traffic lighted sign;  
FIG. 6 is a bottom view of the funeral traffic lighted sign; and,  
FIG. 7 is a top front side perspective view of the funeral traffic lighted sign.

**1 Claim, 6 Drawing Sheets**

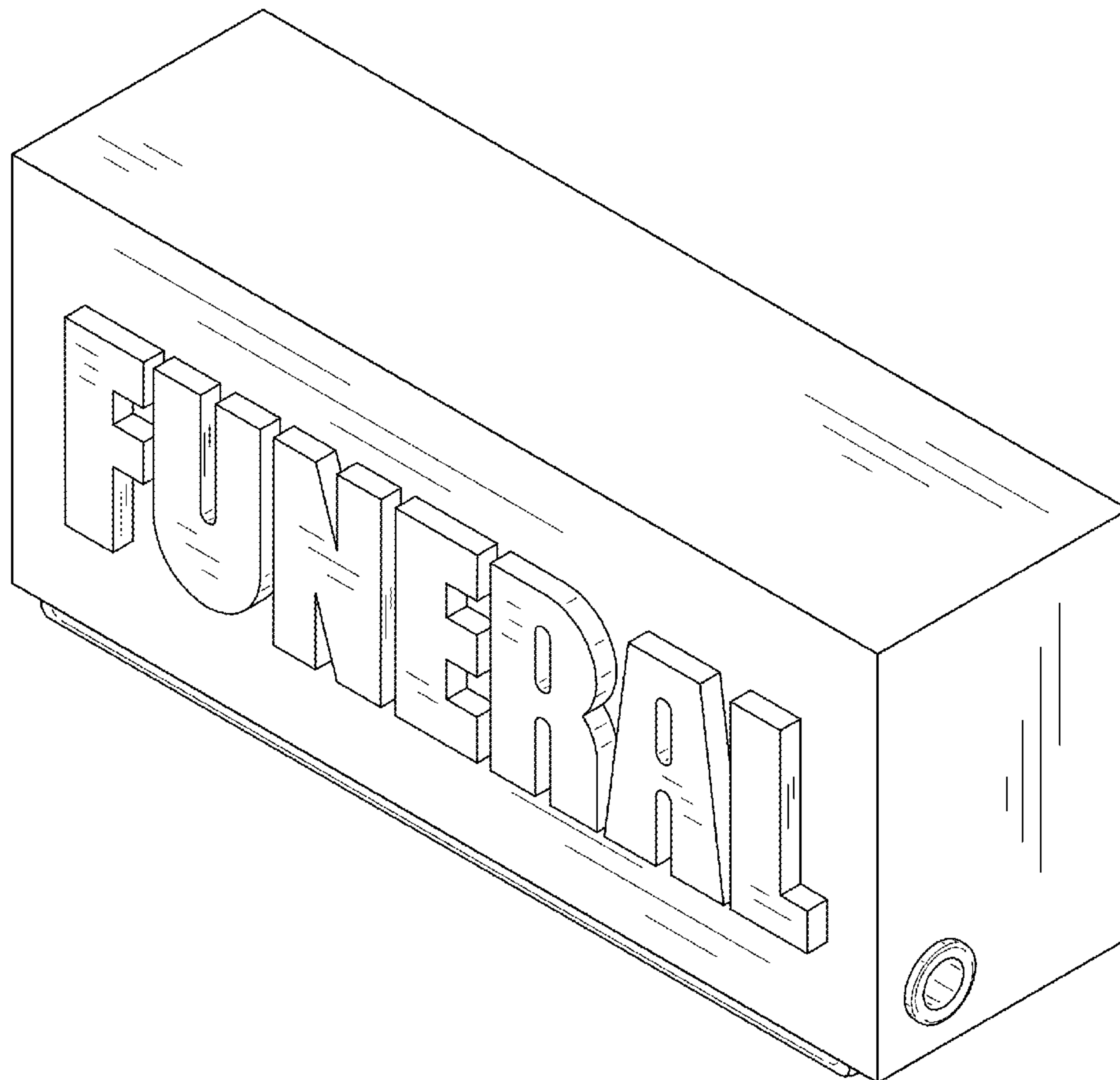

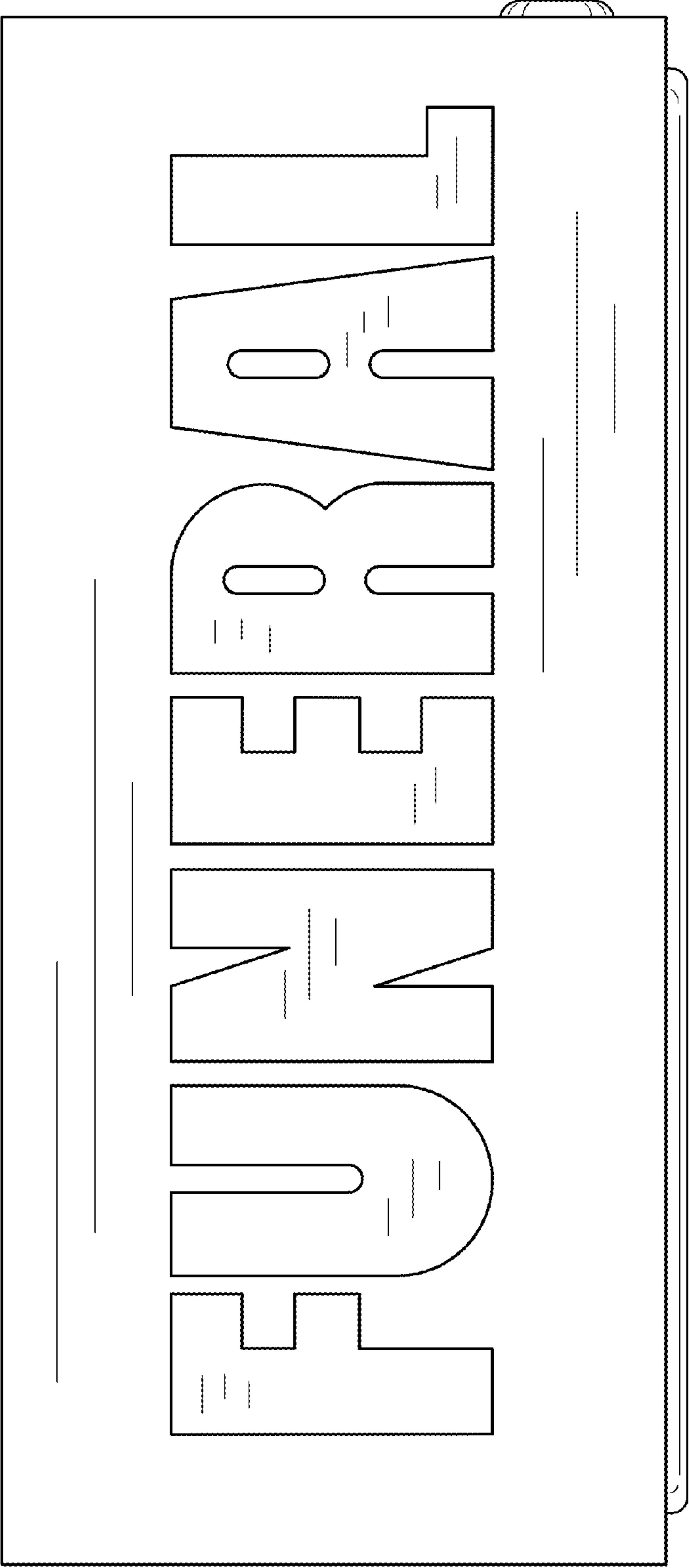

FIG. 1

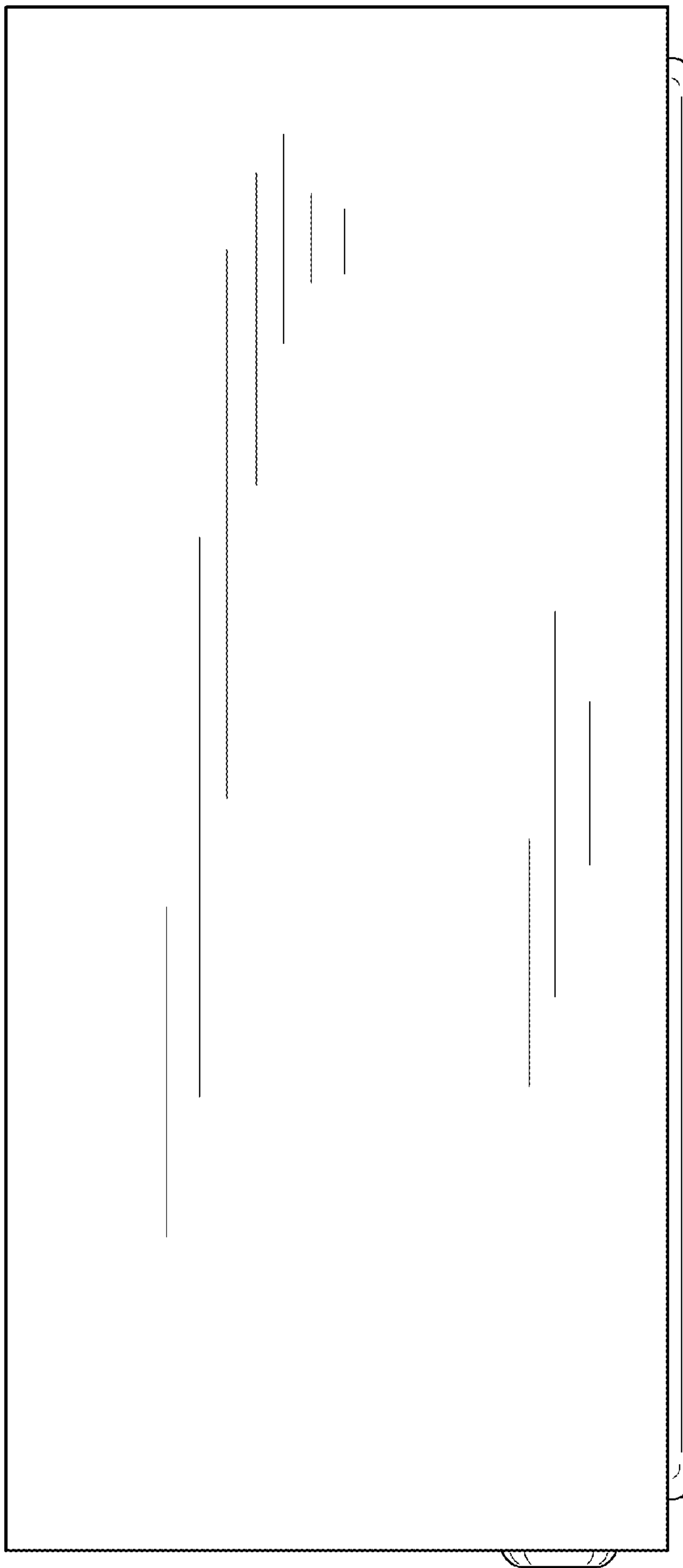

FIG. 2

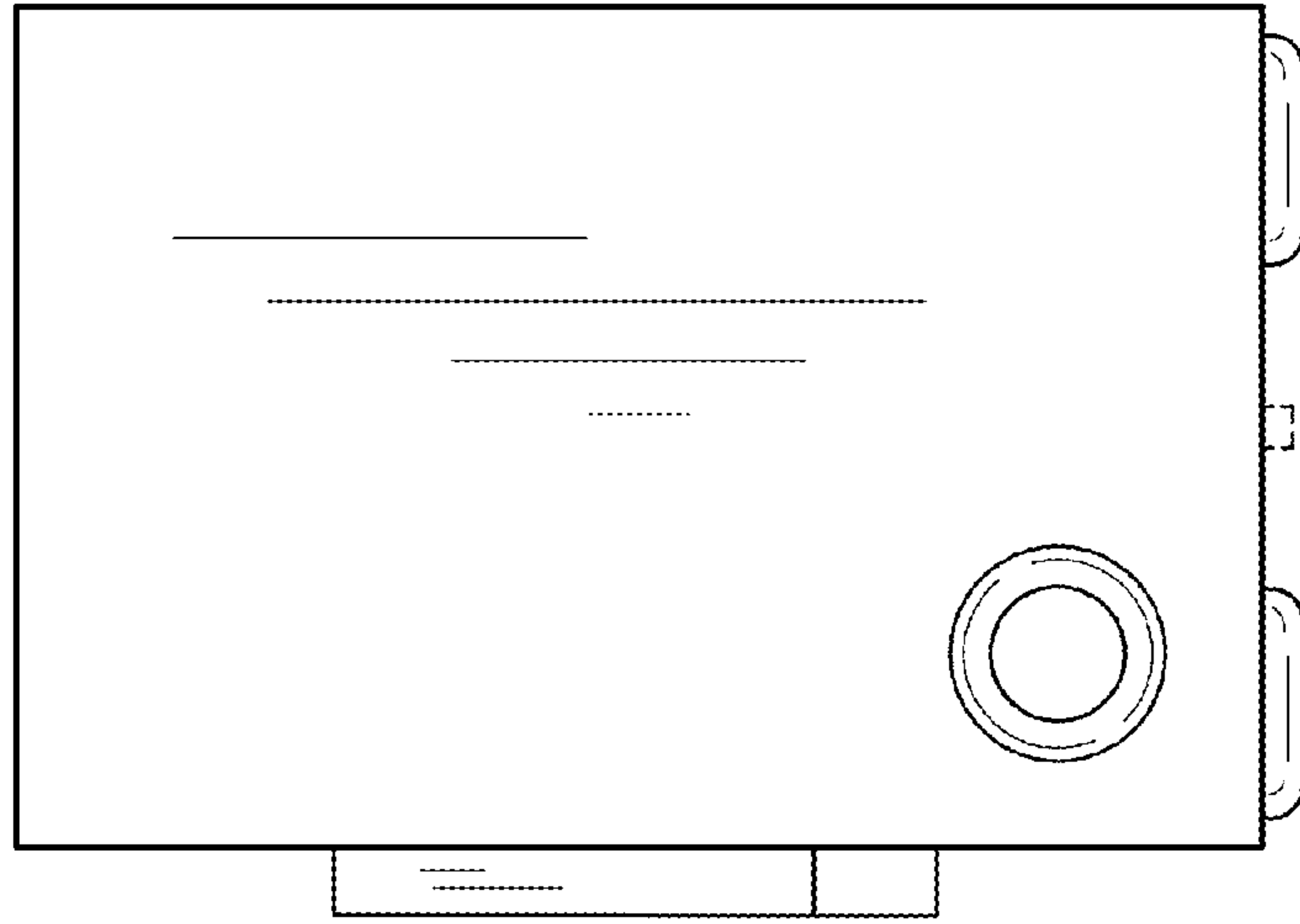

FIG. 4

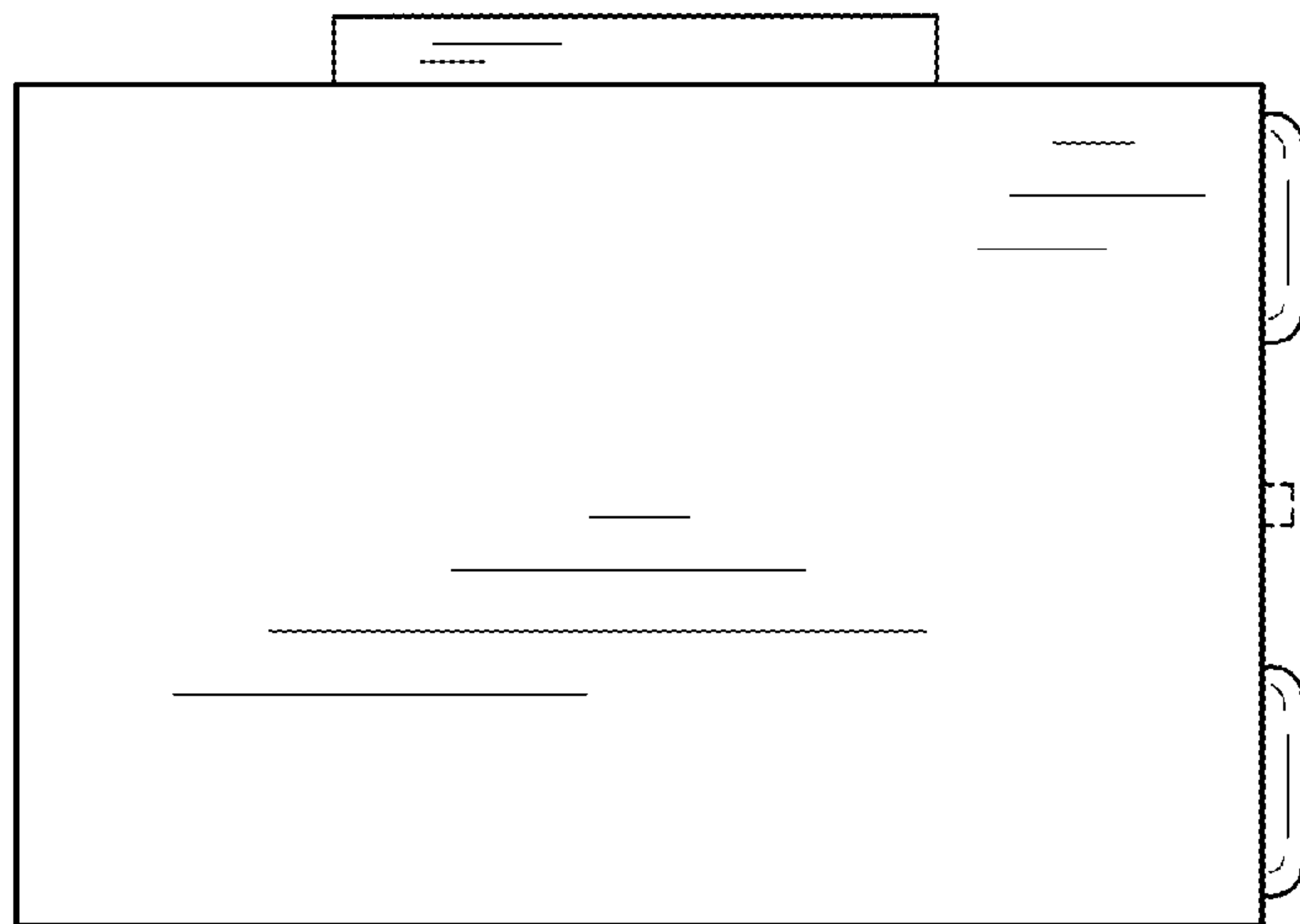

FIG. 3

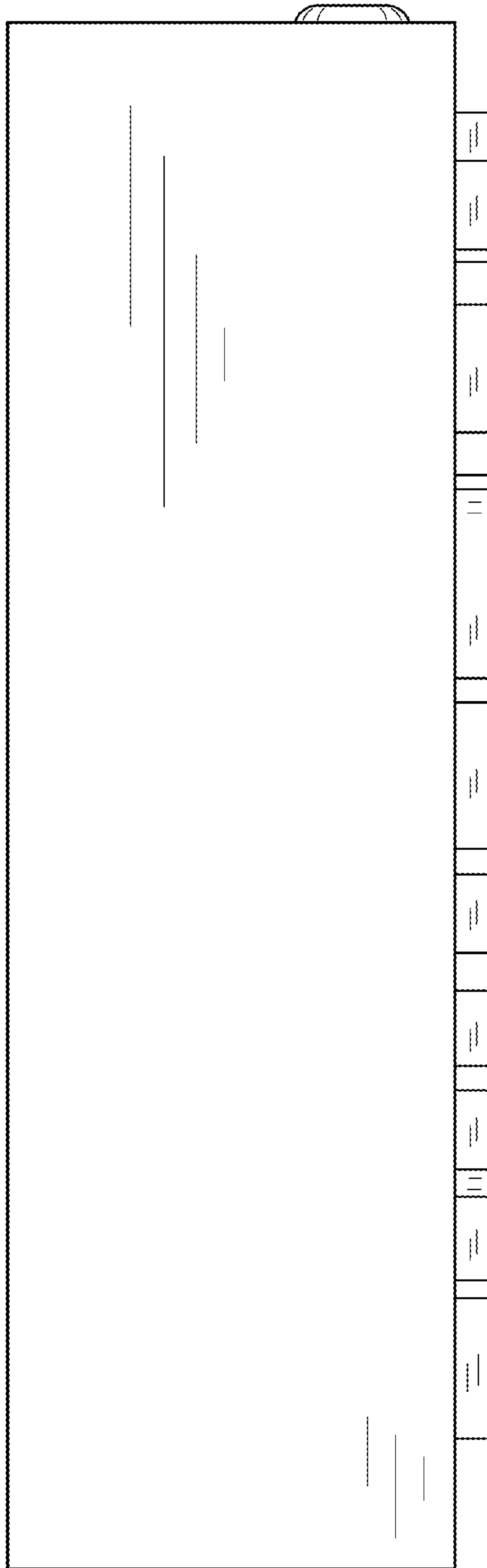

FIG. 5

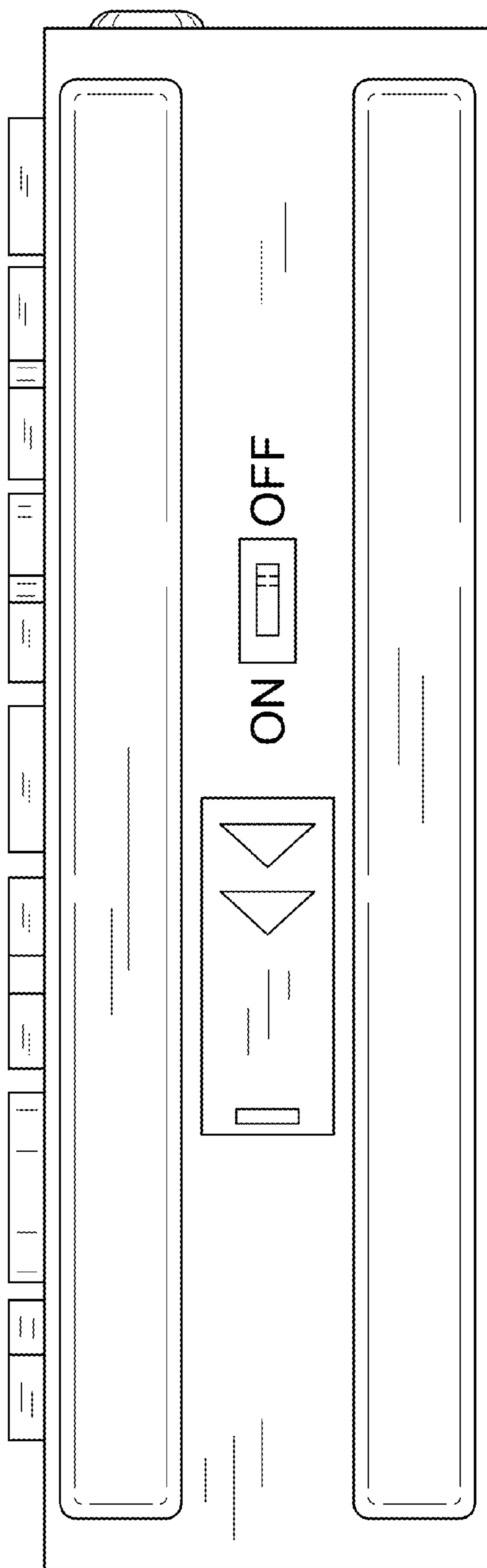

FIG. 6

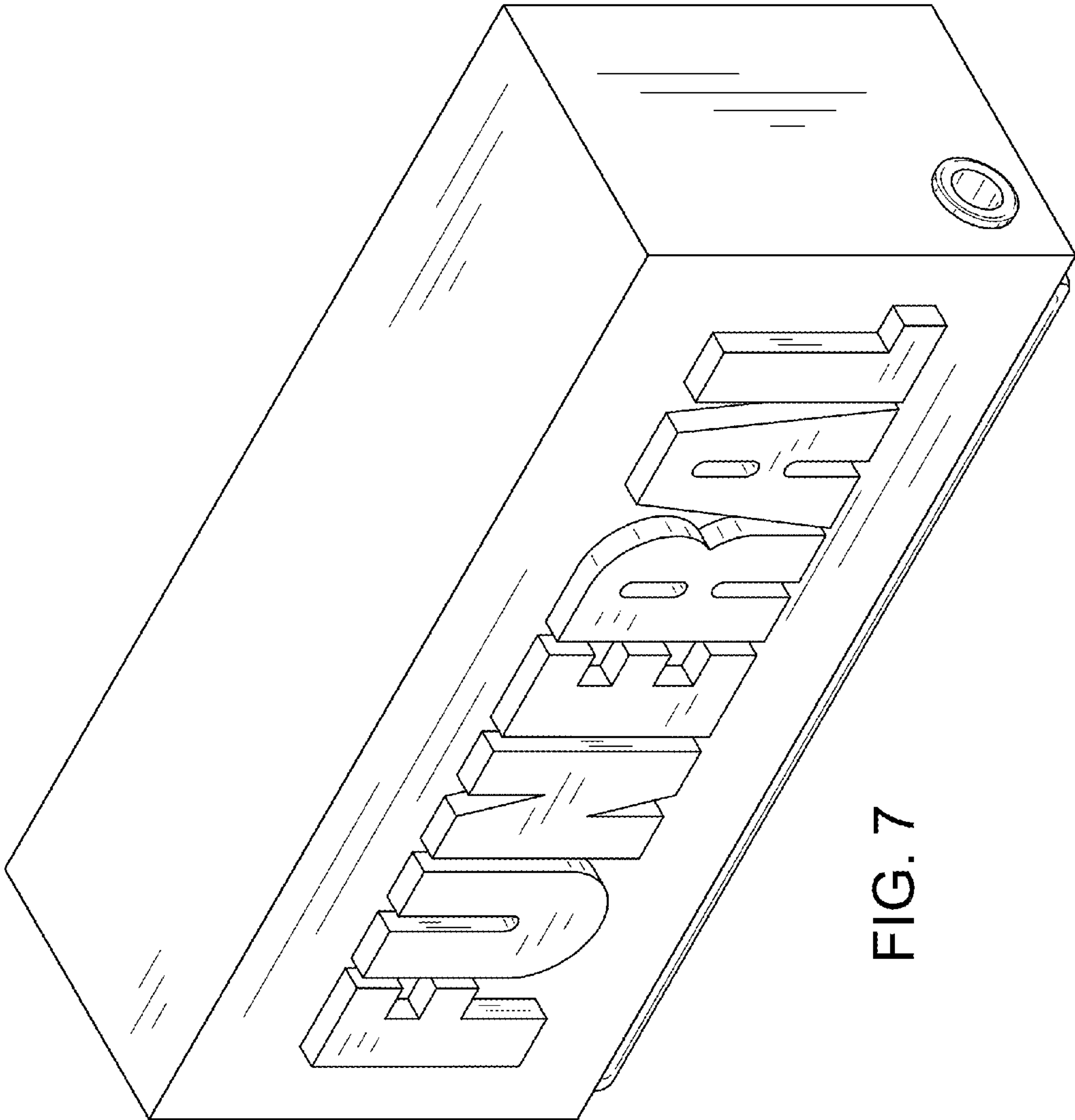

FIG. 7