



US00D755548S

(12) **United States Design Patent**
Berlinches

(10) **Patent No.:** **US D755,548 S**

(45) **Date of Patent:** **** May 10, 2016**

(54) **FRAME FOR A CHAIR**

(71) Applicant: **F. SMIT HOLDING B.V.**, Doetinchem (NL)

(72) Inventor: **David Nadal Berlinches**, Madrid (ES)

(73) Assignee: **F. SMIT HOLDING B.V.**, Doetinchem (NL)

(**) Term: **14 Years**

(21) Appl. No.: **29/508,188**

(22) Filed: **Nov. 4, 2014**

(30) **Foreign Application Priority Data**

May 5, 2014 (EM) 002458091-0001

(51) **LOC (10) Cl.** **06-01**

(52) **U.S. Cl.**
USPC **D6/708.16**

(58) **Field of Classification Search**
USPC D6/334, 335, 336, 338, 349, 355, 381,
D6/716, 716.1, 708.16; 297/118, 119, 135,
297/144, 232, 445.1, 448.1, 452.18, 156,
297/175, 216.1; 5/12.1, 12.2
CPC A47C 1/02; A47C 1/12; A47C 11/00;
A47C 17/00; A47C 17/02; A47C 4/52;
A47C 9/00

See application file for complete search history.

(56) **References Cited**

U.S. PATENT DOCUMENTS

4,361,357 A * 11/1982 Pollock A47C 5/04
248/188.7
5,626,395 A * 5/1997 Aufreere B60N 2/682
297/344.15
5,636,901 A * 6/1997 Grilliot B60N 2/015
248/188.1
6,139,109 A * 10/2000 Lajoie A47C 3/12
269/37

D557,044 S * 12/2007 Lee D6/708.16
7,469,967 B1 * 12/2008 Hori B60N 2/3013
297/354.12
8,172,318 B2 * 5/2012 Kruger B60N 2/4221
297/216.1
2015/0274045 A1 * 10/2015 Riley B60N 2/4235
297/344.1

* cited by examiner

Primary Examiner — Sandra Snapp

(74) *Attorney, Agent, or Firm* — Abelman, Frayne & Schwab

(57) **CLAIM**

The ornamental design for a frame for a chair, as shown and described.

DESCRIPTION

FIG. 1 is an isometric front left view showing my design;
FIG. 2 is an isometric front left view showing my design,
along with an outline of a chair, which is not part of the
claimed design;
FIG. 3 is an isometric rear right view showing my design;
FIG. 4 is an isometric rear right view showing my design,
along with an outline of a chair, which is not part of the
claimed design;
FIG. 5 is a back view showing my design;
FIG. 6 is a bottom view showing my design;
FIG. 7 is a front view showing my design;
FIG. 8 is a left side view showing my design;
FIG. 9 is perspective view of the left side of my design;
FIG. 10 is a perspective view of the left side of my design,
along with an outline of a chair, which is not part of the
claimed design;
FIG. 11 is a perspective view of the right side of my design;
FIG. 12 is a perspective view of the right side of my design,
along with an outline of a chair, which is not part of the
claimed design;
FIG. 13 is a right side view showing my design; and,
FIG. 14 is a top view showing my design.

1 Claim, 14 Drawing Sheets

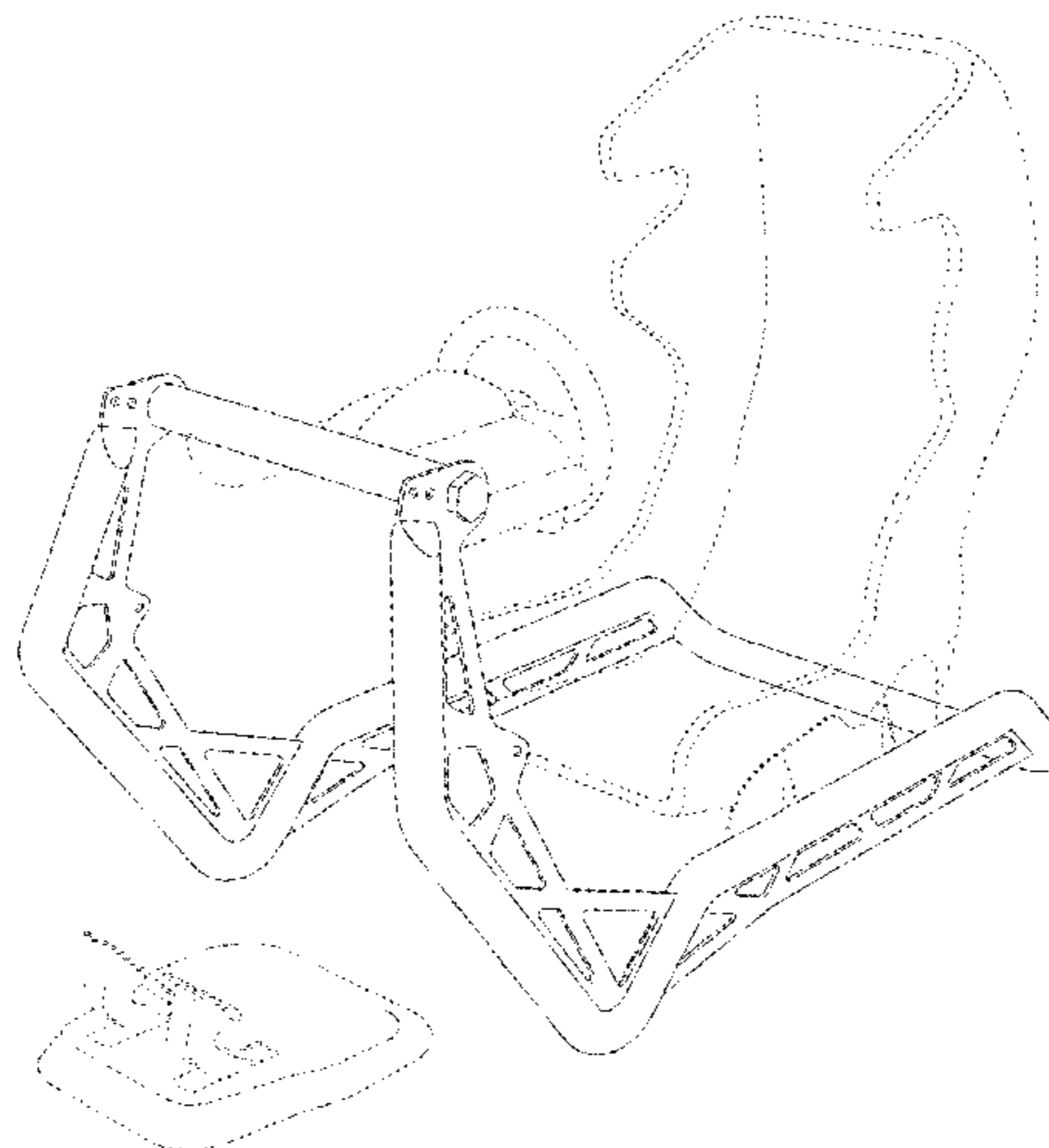

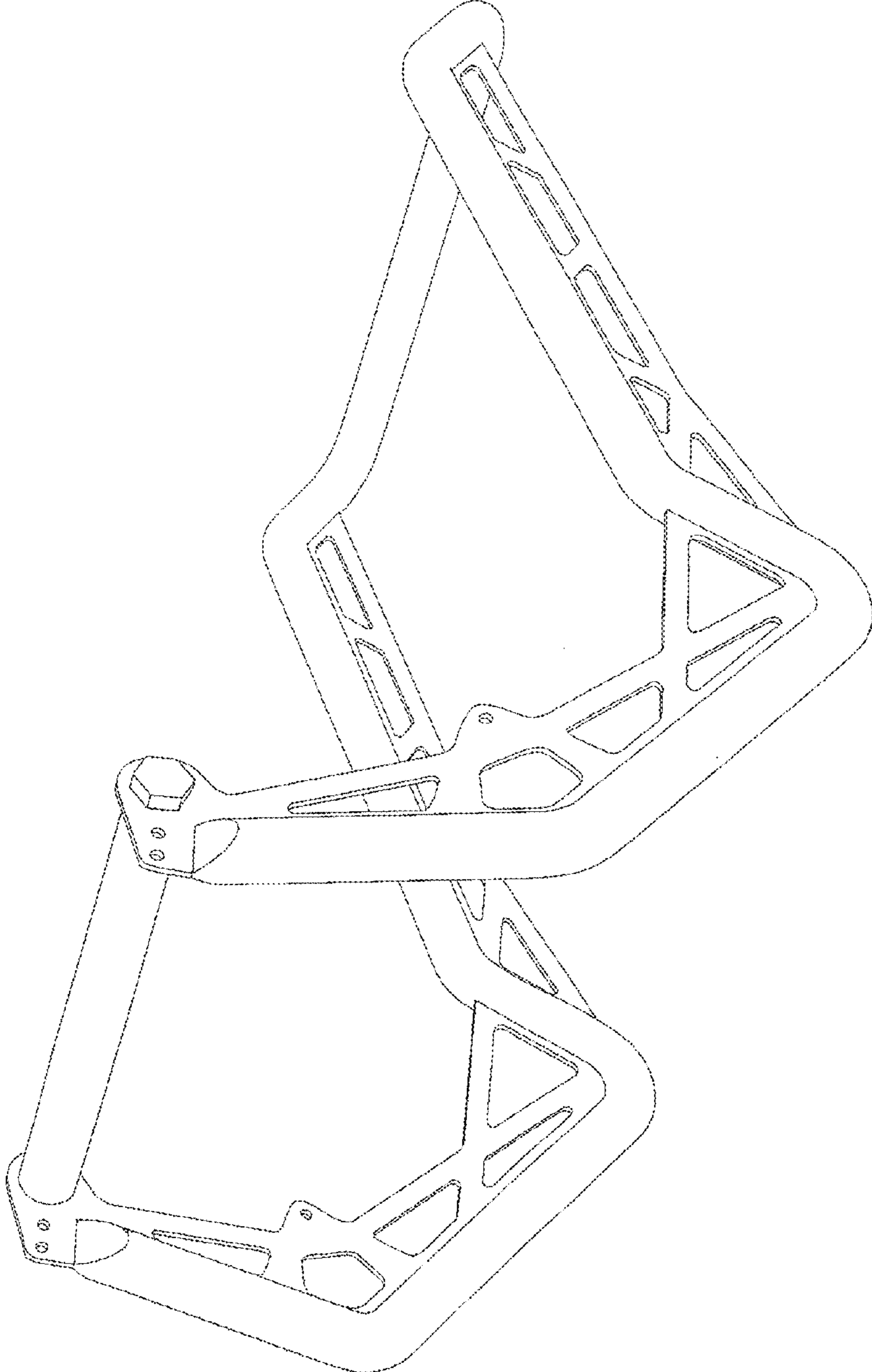

Figure 1

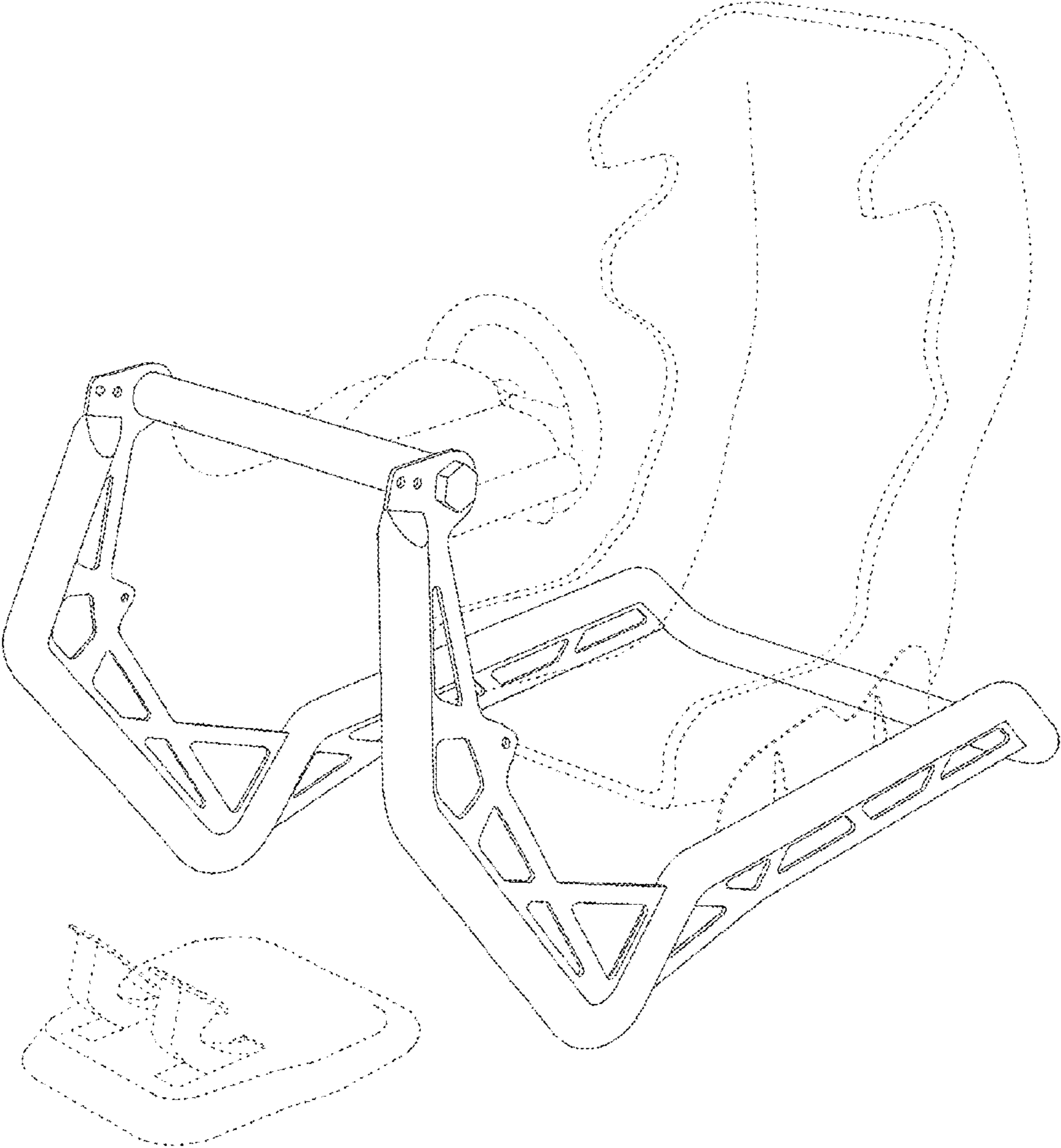

Figure 2

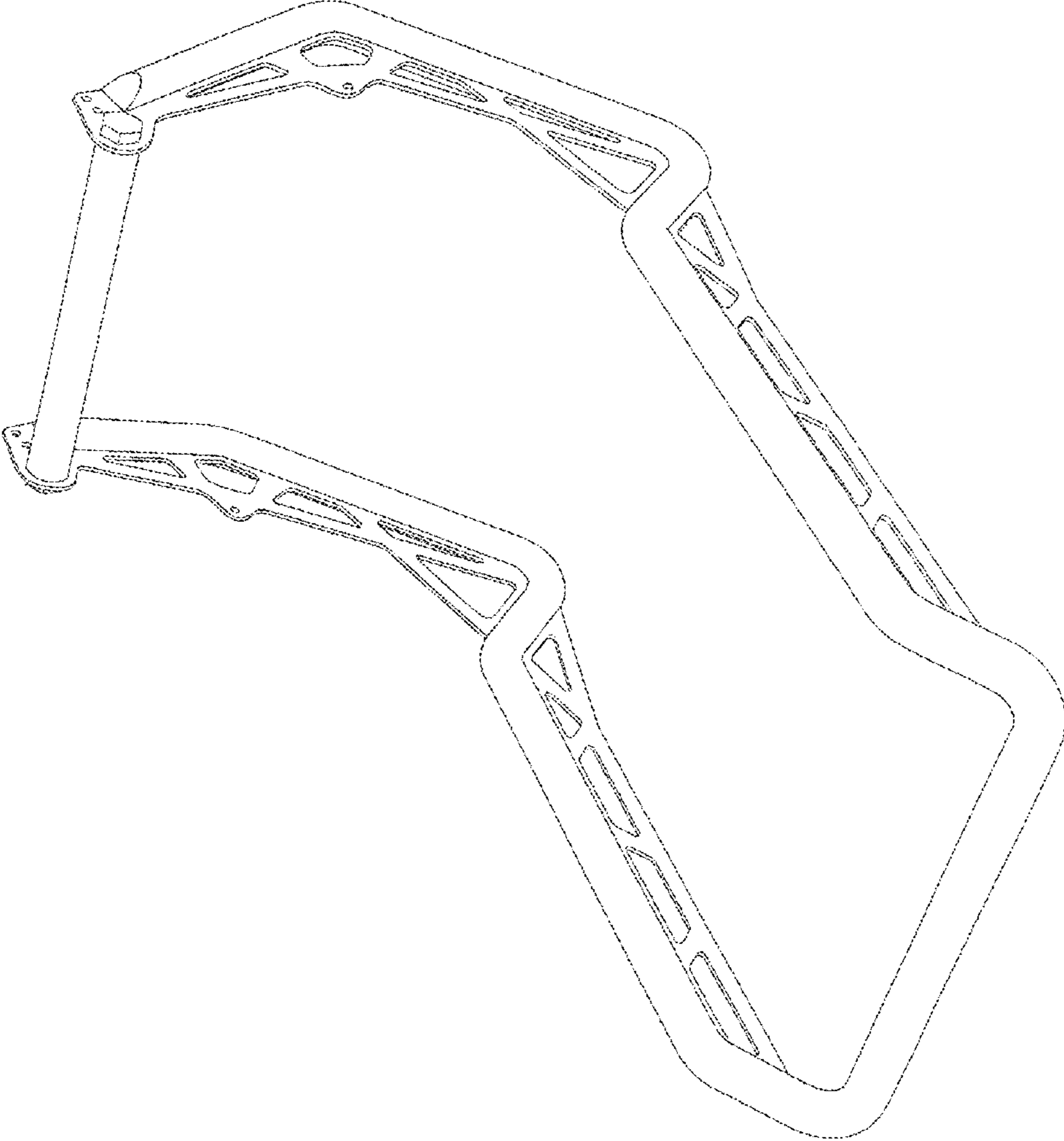

Figure 3

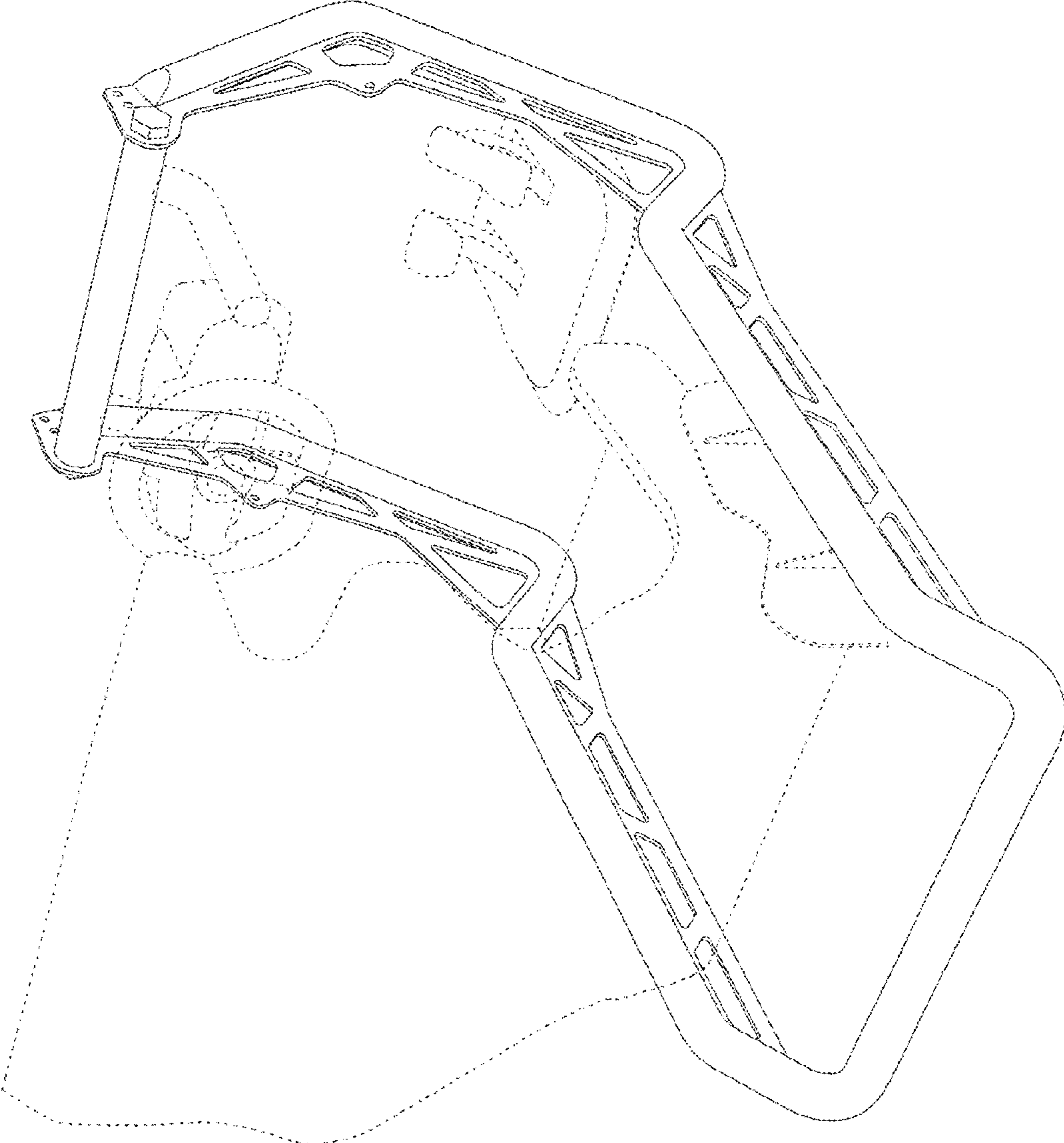

Figure 4

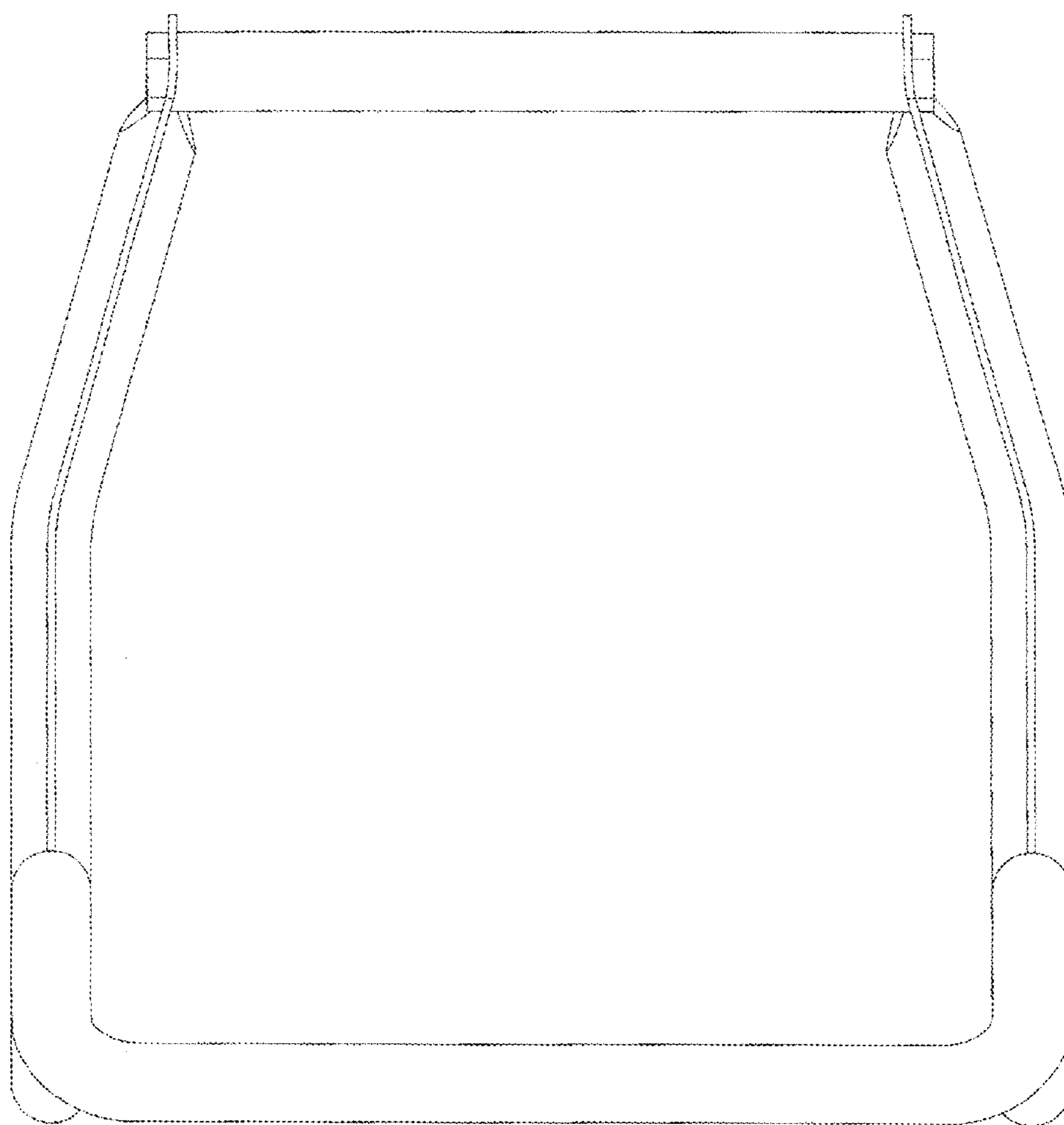

Figure 5

Figure 6

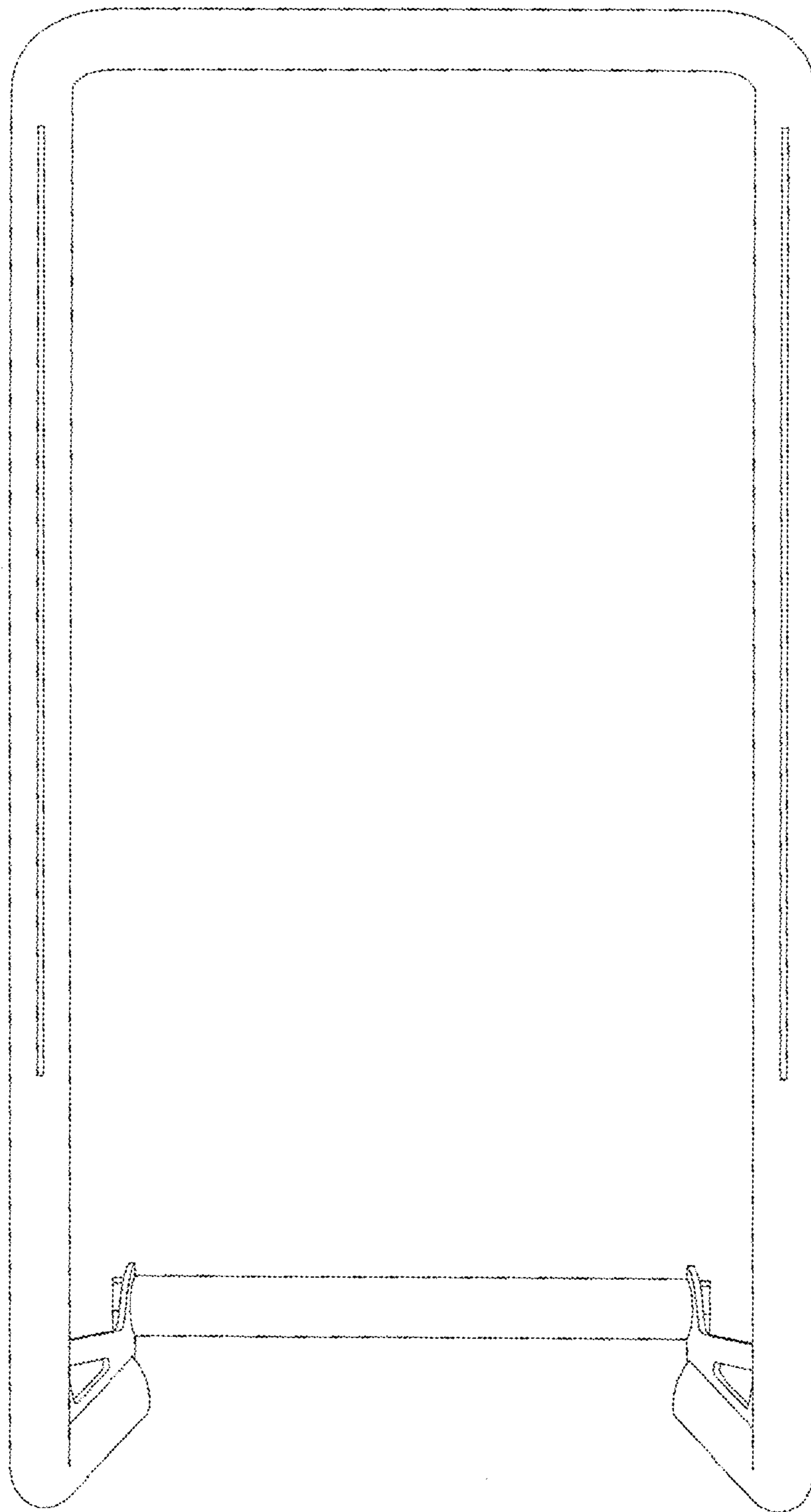
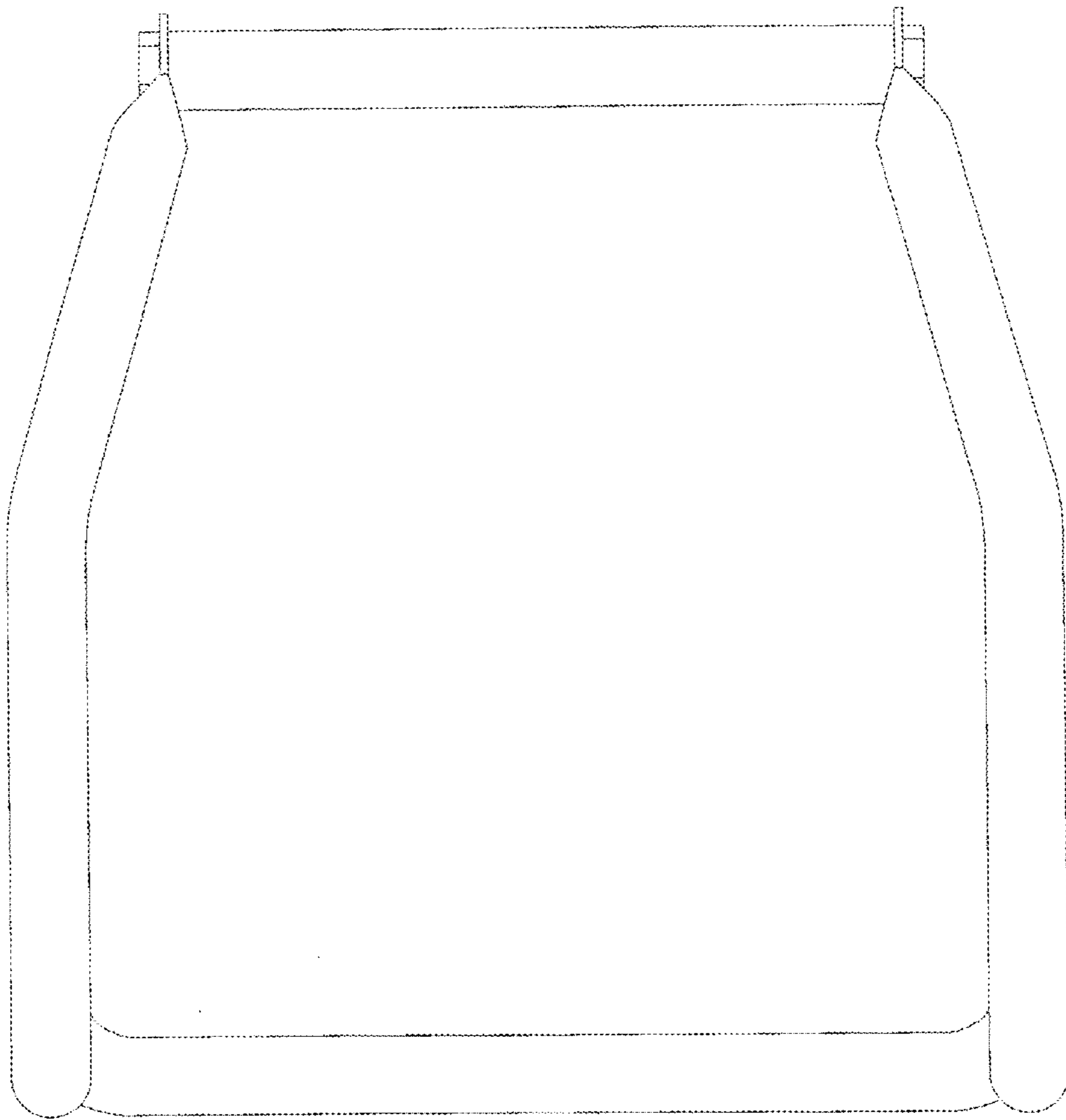

Figure 7



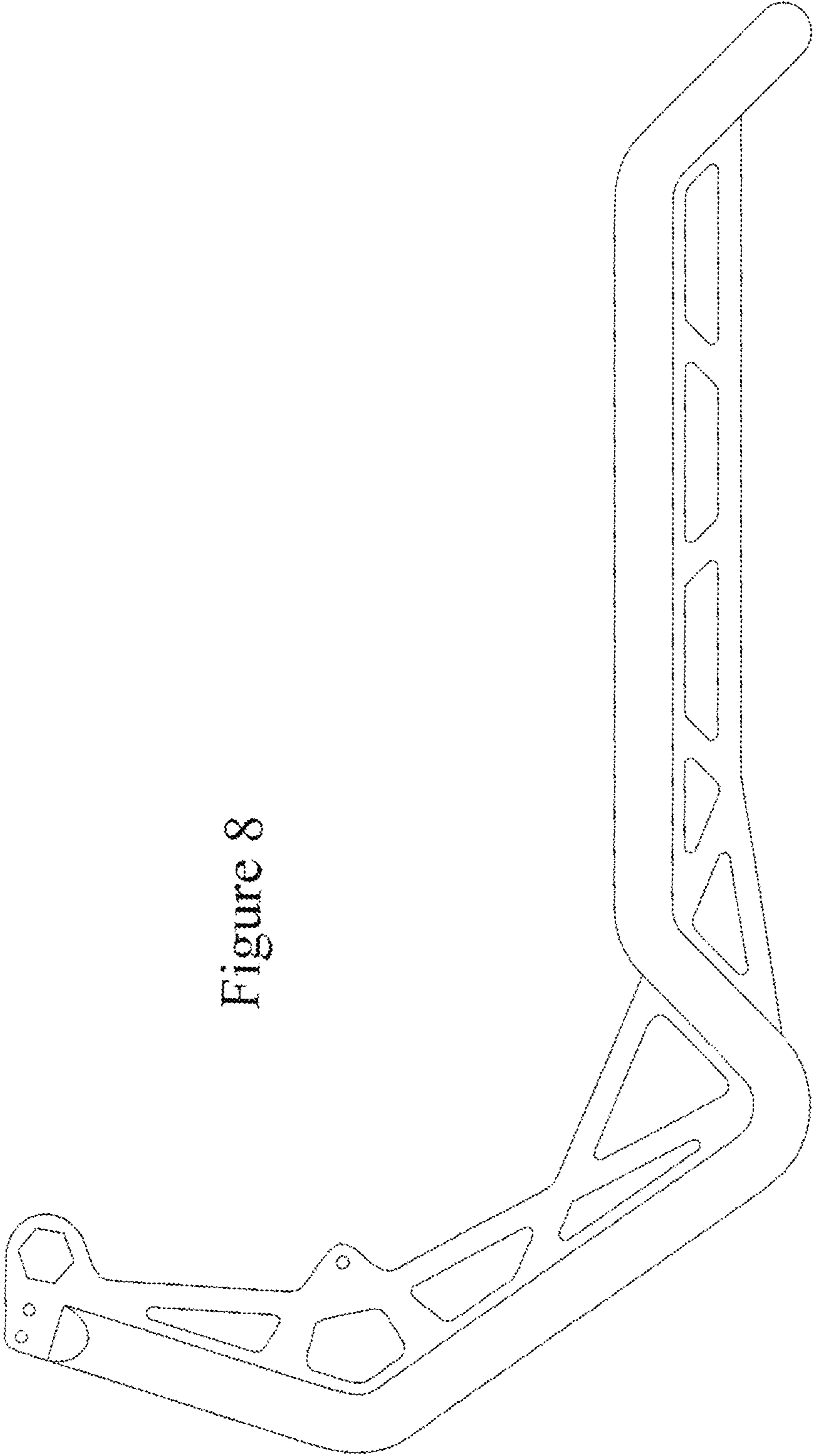

Figure 8

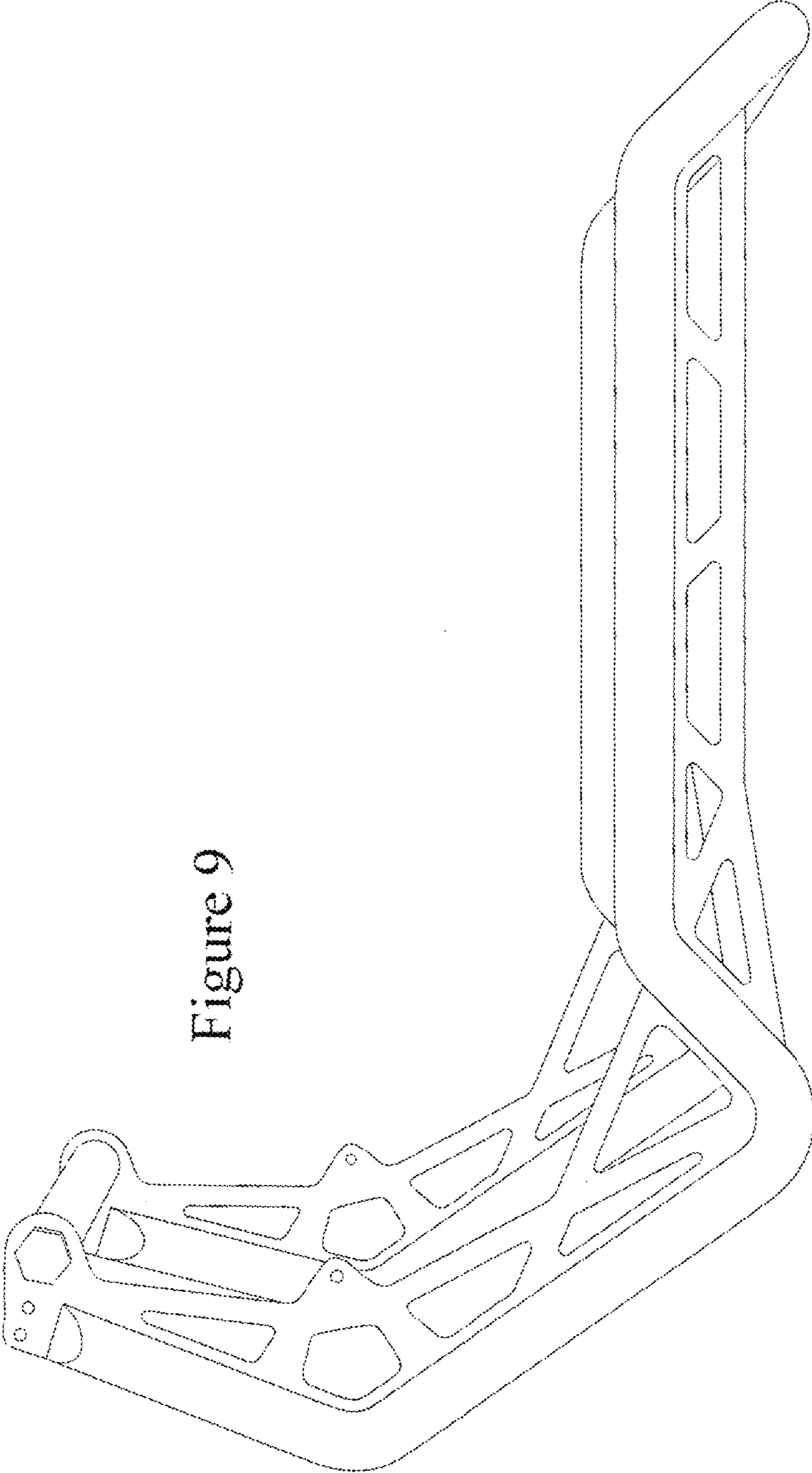

Figure 9

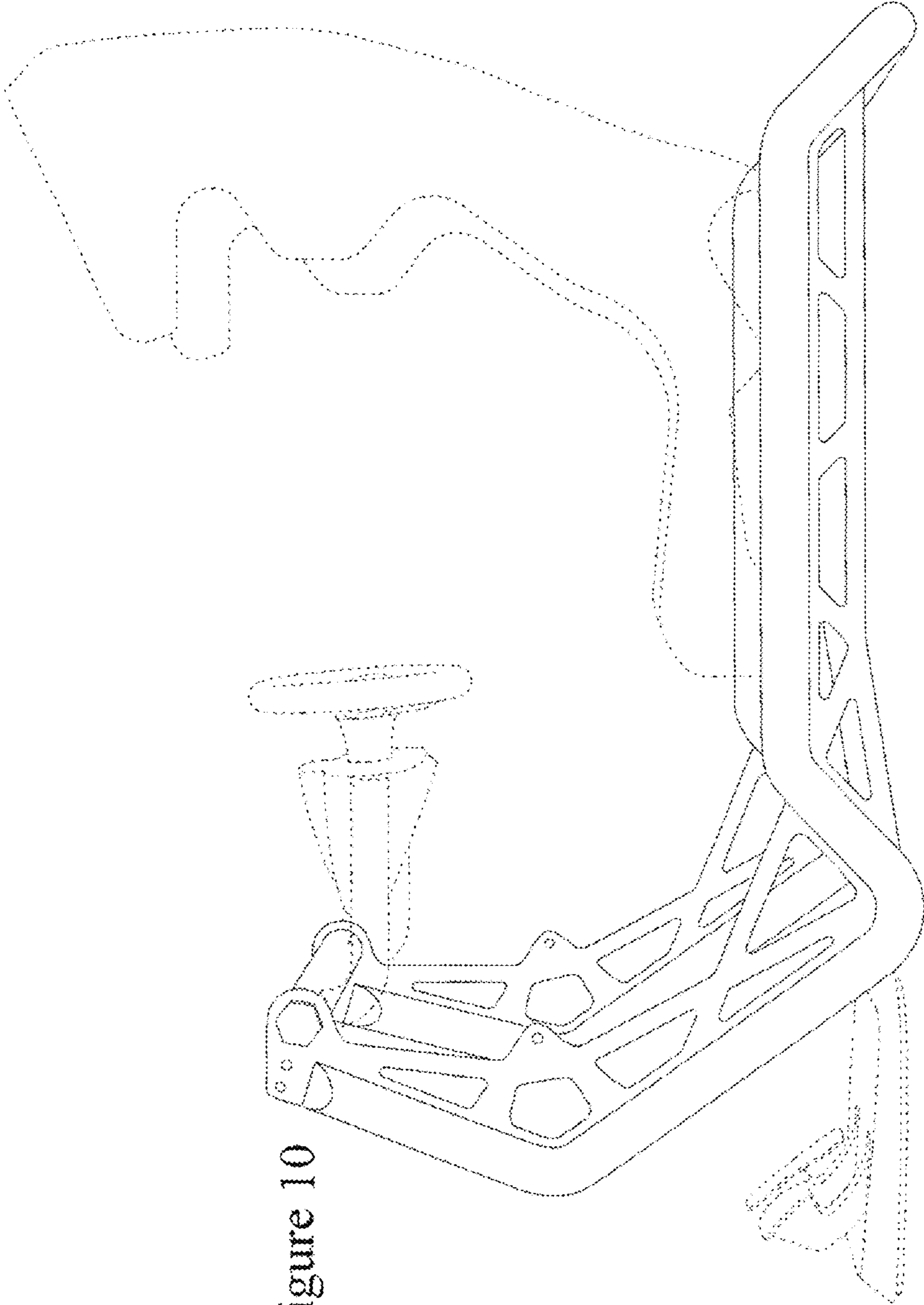

Figure 10

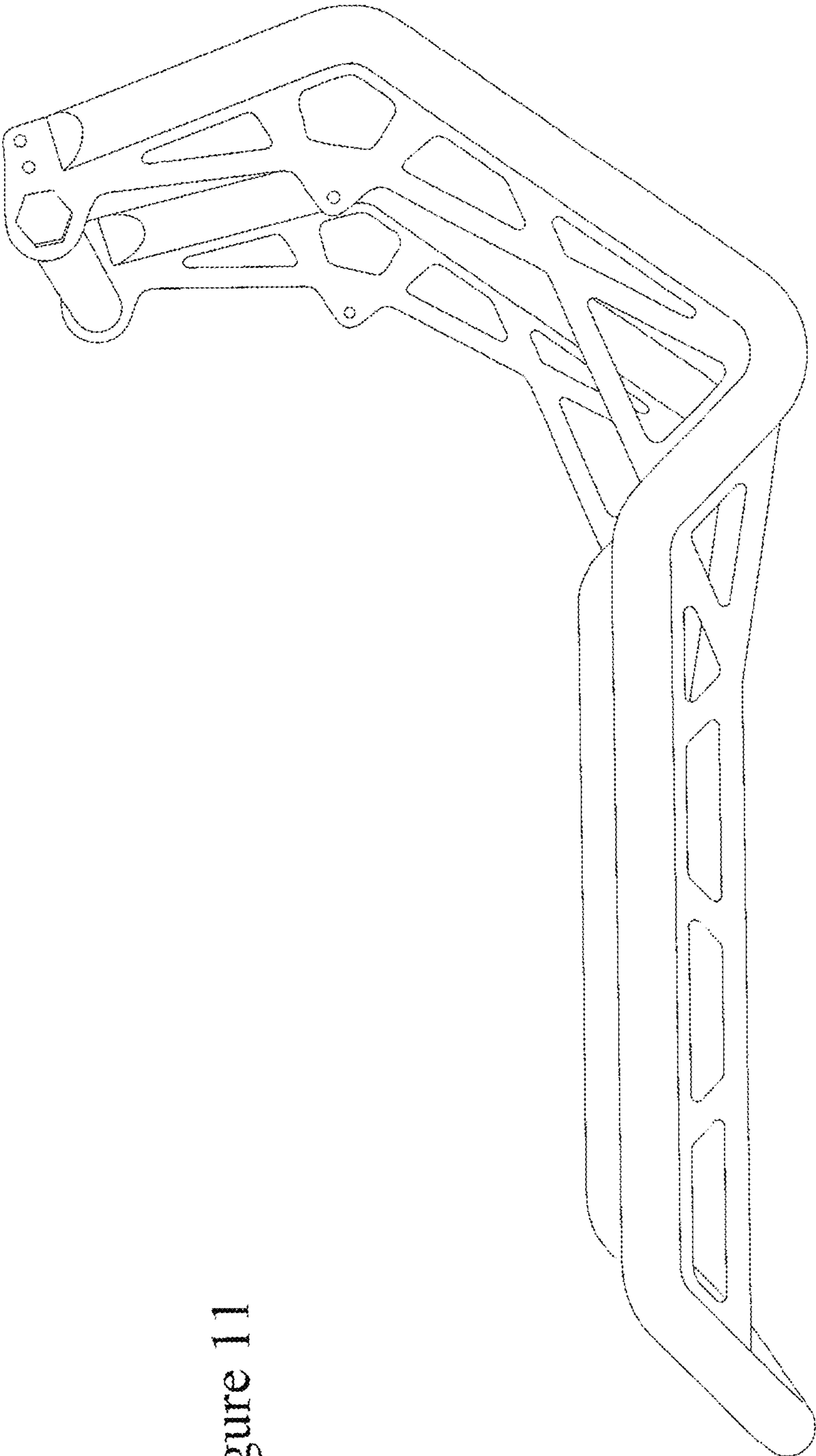
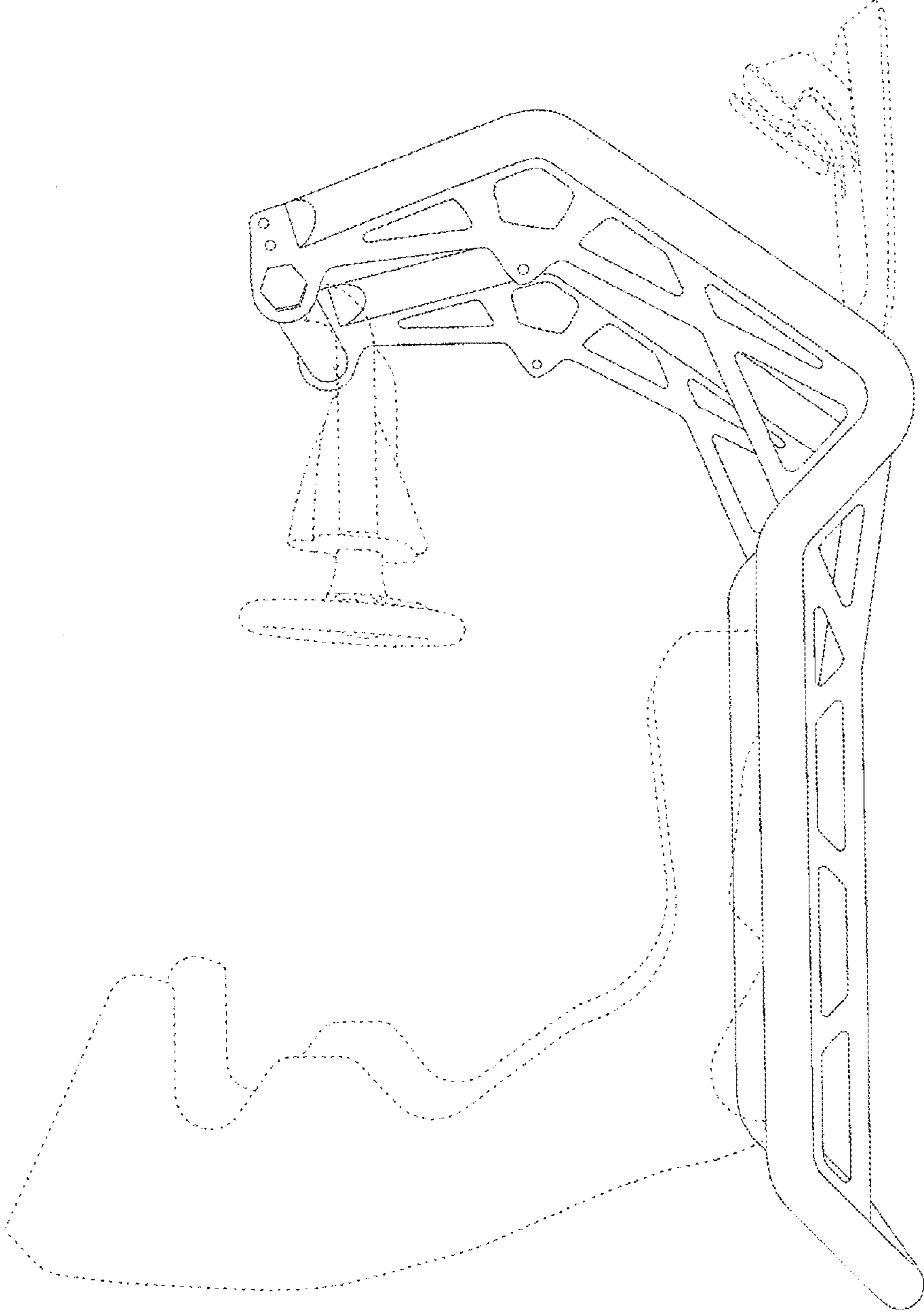

Figure 11

Figure 12



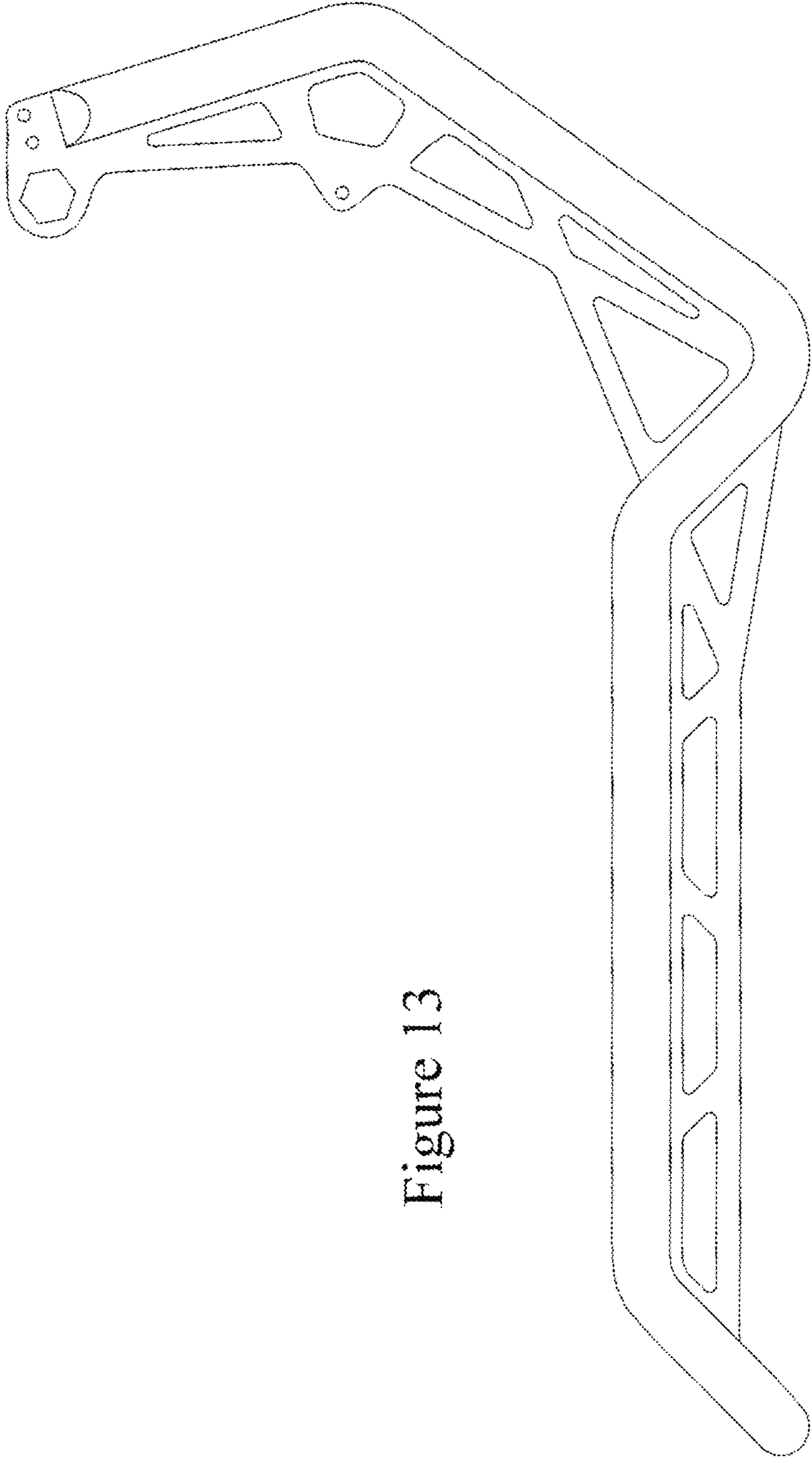

Figure 13

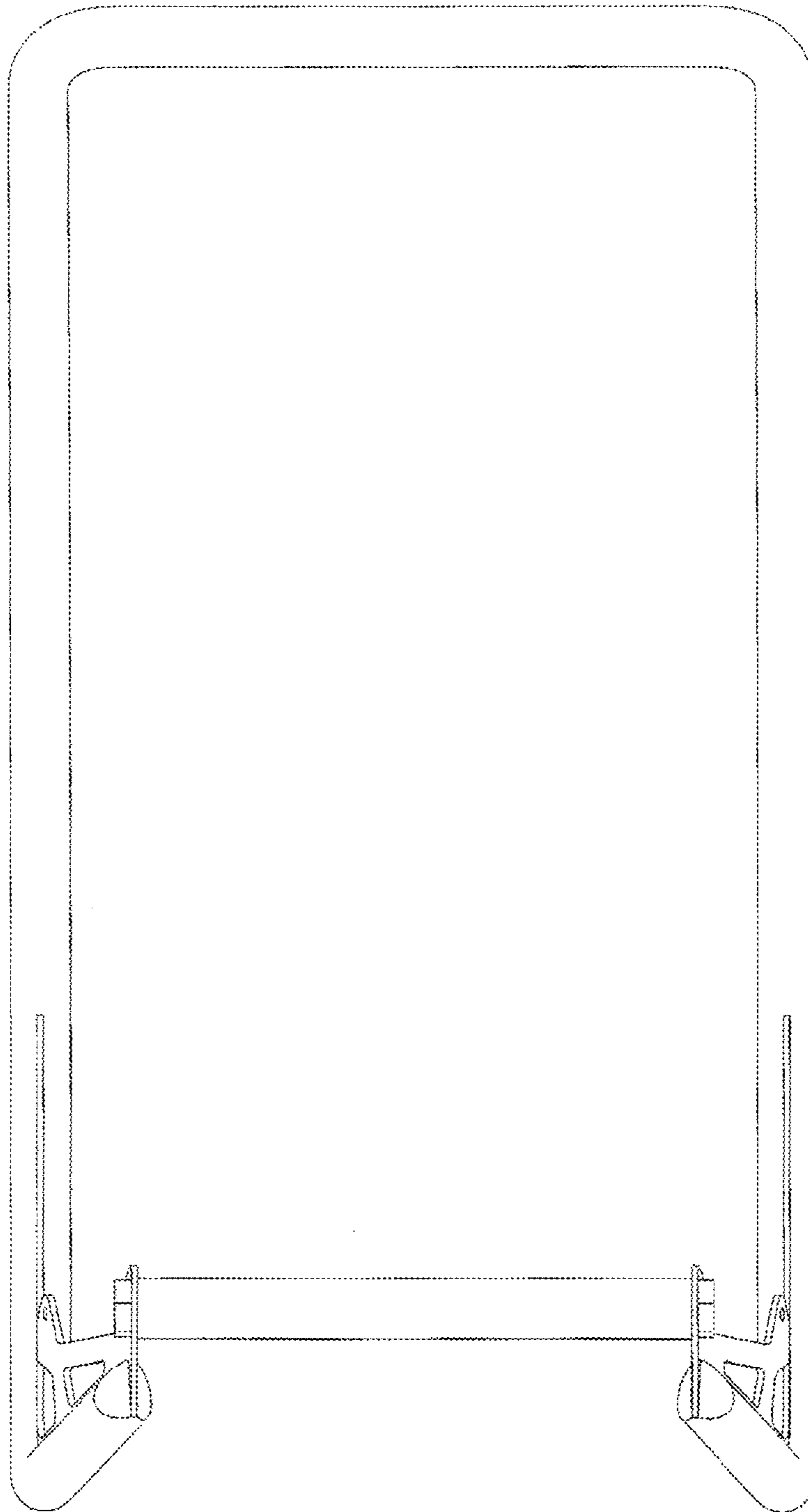

Figure 14