



US00D75521S

(12) **United States Design Patent**
Wei

(10) **Patent No.:** **US D755,521 S**

(45) **Date of Patent:** **** May 10, 2016**

(54) **LUGGAGE SLEEVE**

(71) Applicant: **Christopher C. Wei**, Yorba Linda, CA
(US)

(72) Inventor: **Christopher C. Wei**, Yorba Linda, CA
(US)

(**) Term: **14 Years**

(21) Appl. No.: **29/484,904**

(22) Filed: **Mar. 13, 2014**

(51) **LOC (10) Cl.** **03-01**

(52) **U.S. Cl.**
USPC **D3/318**

(58) **Field of Classification Search**
USPC D3/318
CPC A45C 13/00; B65D 65/02
See application file for complete search history.

(56) **References Cited**

U.S. PATENT DOCUMENTS

7,441,641 B2 * 10/2008 Beakey A45C 13/002
150/105
D667,635 S * 9/2012 Sanchez D3/318
D696,516 S * 12/2013 Caspi D3/318

* cited by examiner

Primary Examiner — Holly Baynham

(74) *Attorney, Agent, or Firm* — Buche & Associates, P.C.;
John K. Buche; Bryce A. Johnson

(57) **CLAIM**

I claim the ornamental design of a luggage sleeve, as shown and described.

DESCRIPTION

FIG. 1 is a perspective front view of a luggage sleeve.
FIG. 2 is another perspective front view of the luggage sleeve.
FIG. 3 is a front view of the luggage sleeve.
FIG. 4 is a back view of the luggage sleeve.
FIG. 5 is a top view of the luggage sleeve.
FIG. 6 is a bottom view of the luggage sleeve.
FIG. 7 is a left side view of the luggage sleeve.
FIG. 8 is a right side view of the luggage sleeve.
FIG. 9 is an environmental view of the luggage sleeve on a suitcase.
FIG. 10 is an environmental, perspective front view thereof;
FIG. 11 is another environmental, perspective front view thereof;
FIG. 12 is a front view of an alternate embodiment of the luggage sleeve.
FIG. 13 is a back view of the alternate embodiment of the luggage sleeve.
FIG. 14 is a top view of the alternate embodiment of the luggage sleeve.
FIG. 15 is a bottom view of the alternate embodiment of the luggage sleeve.
FIG. 16 is a left side view of the alternate embodiment of the luggage sleeve; and,
FIG. 17 is a right side view of the alternate embodiment of the luggage sleeve.
The broken lines of the Figures illustrate items that form no part of the claimed design.

1 Claim, 11 Drawing Sheets

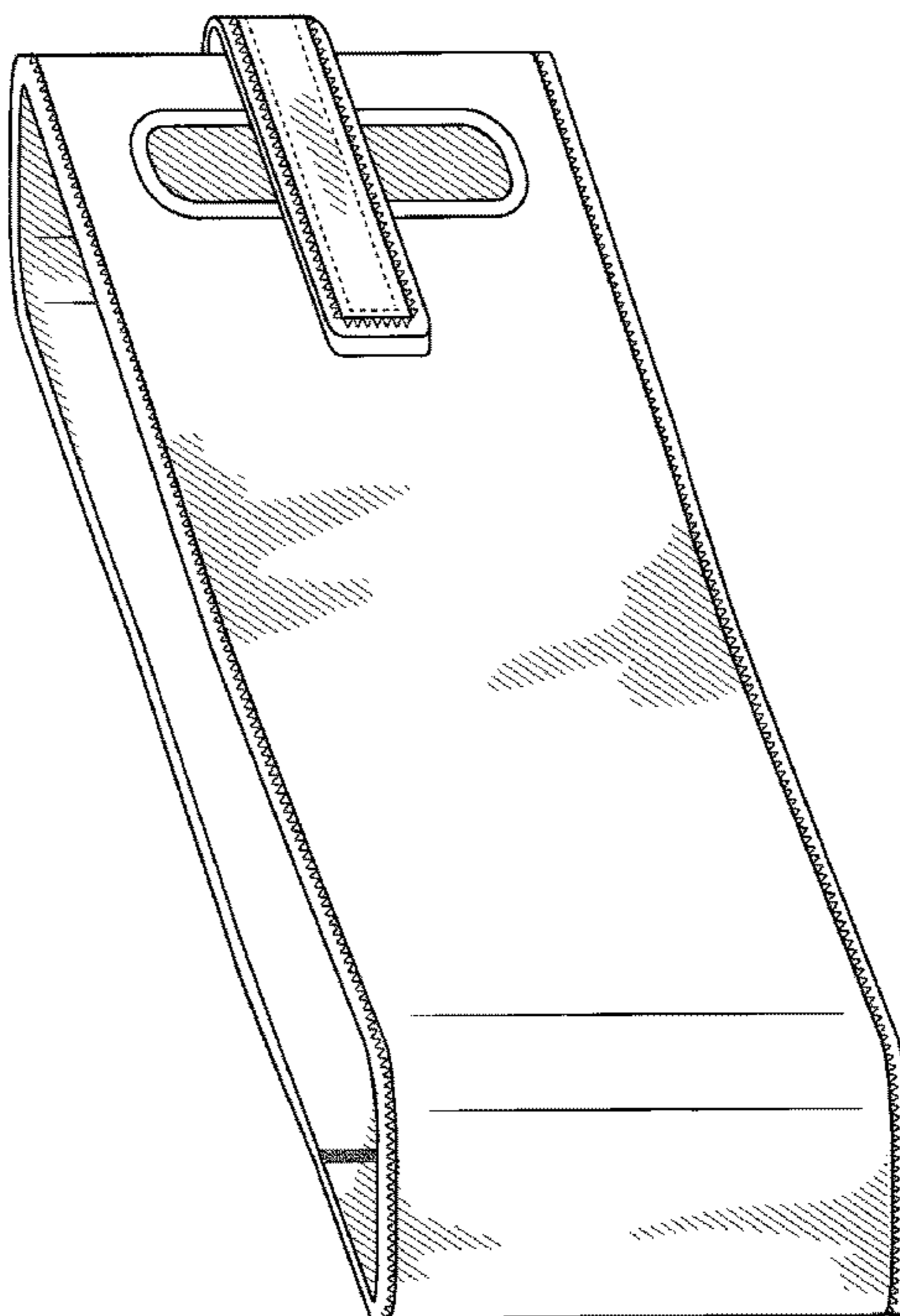

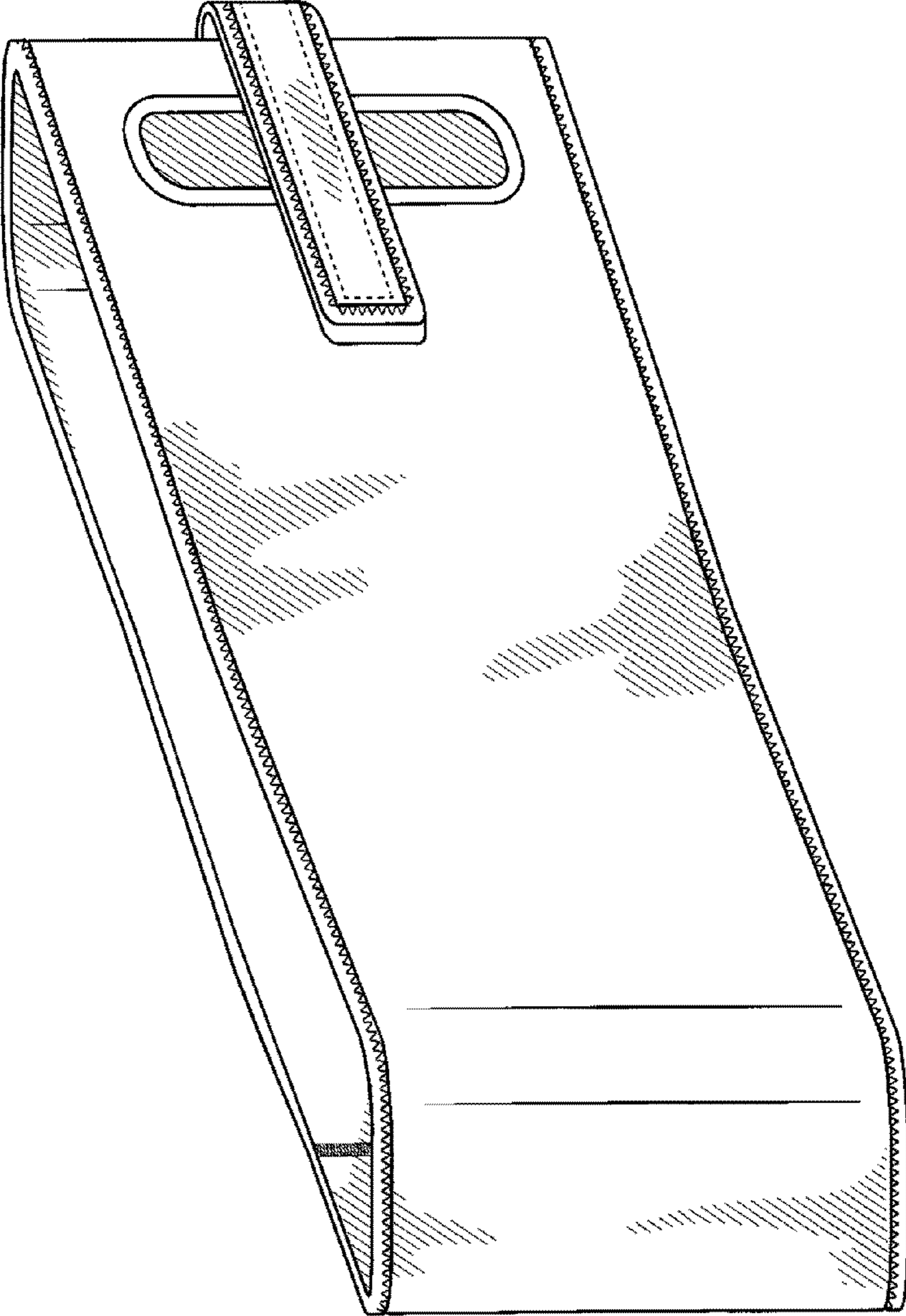

FIG. 1

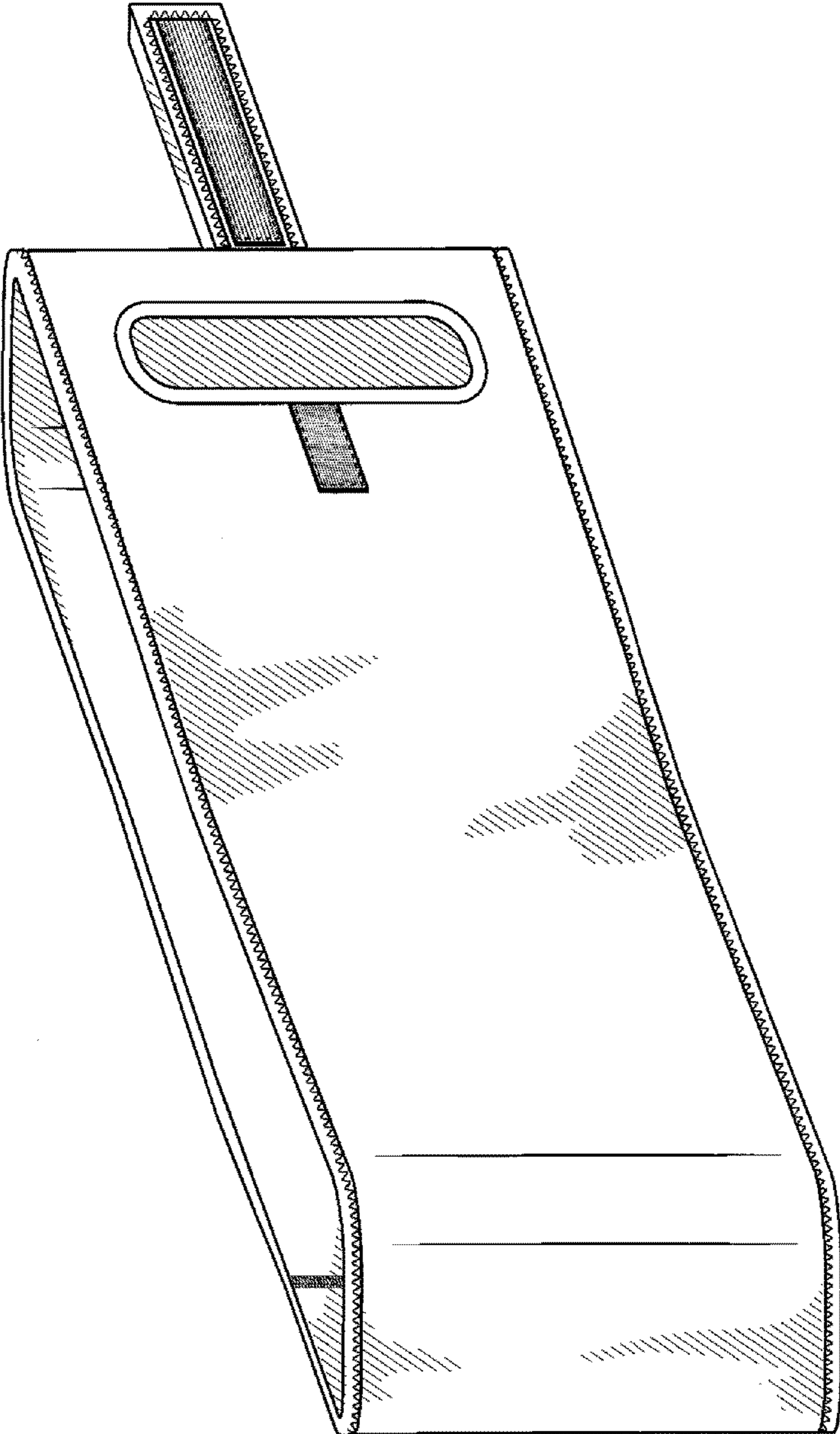

FIG. 2

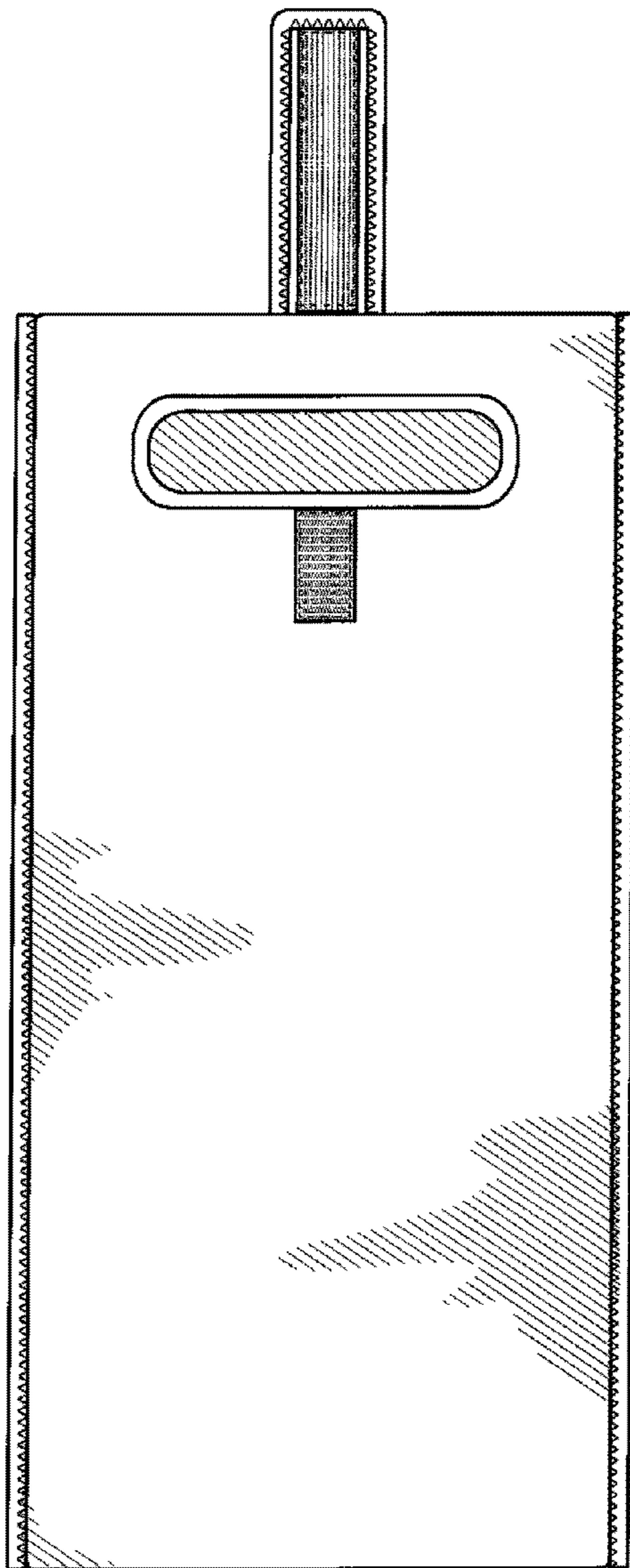

FIG. 3

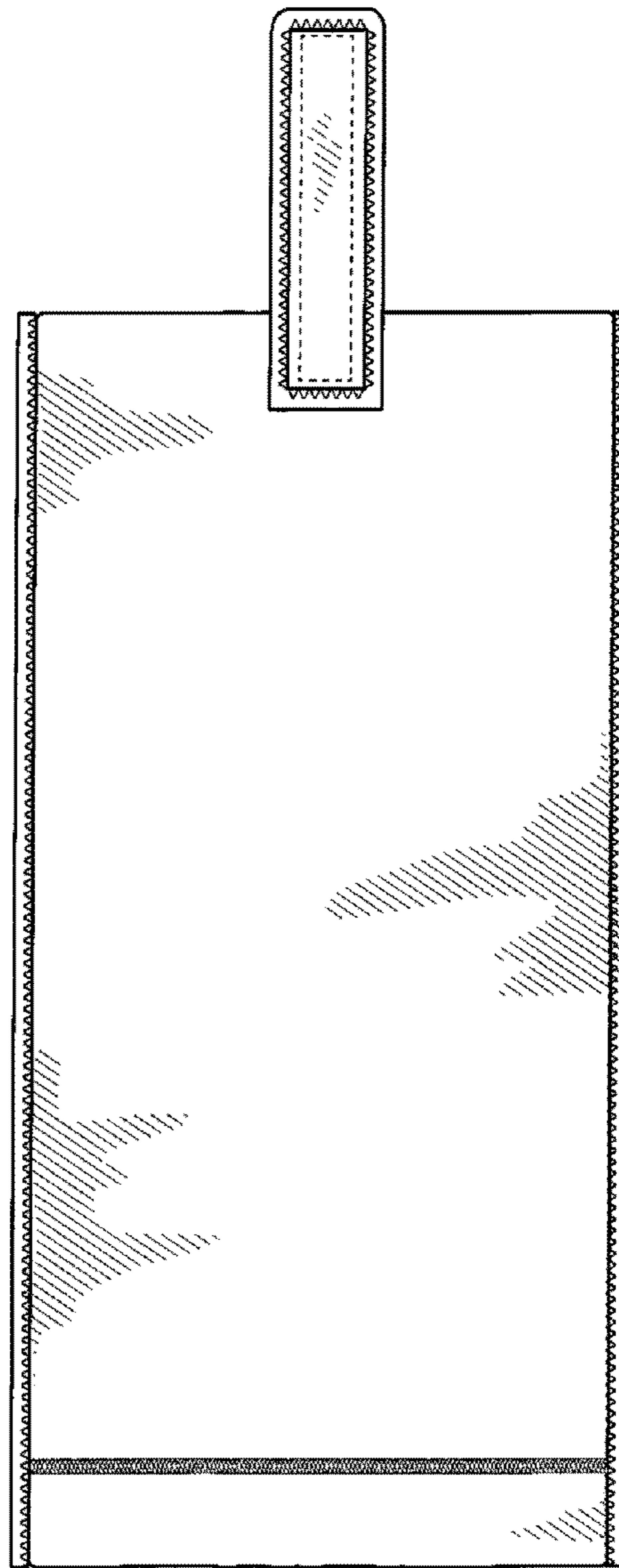

FIG. 4

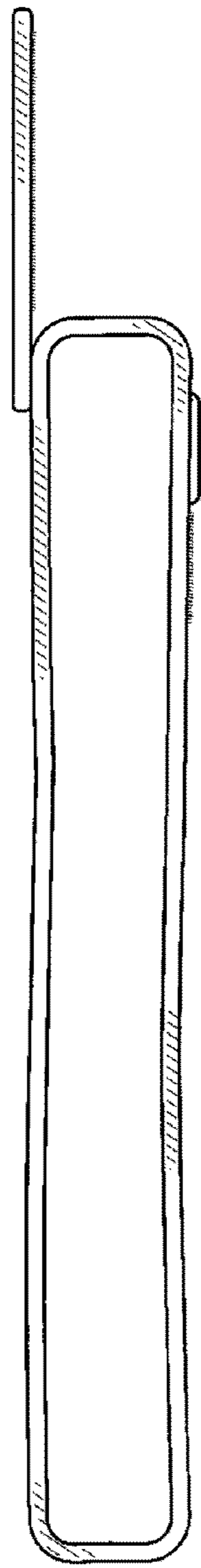

FIG. 5

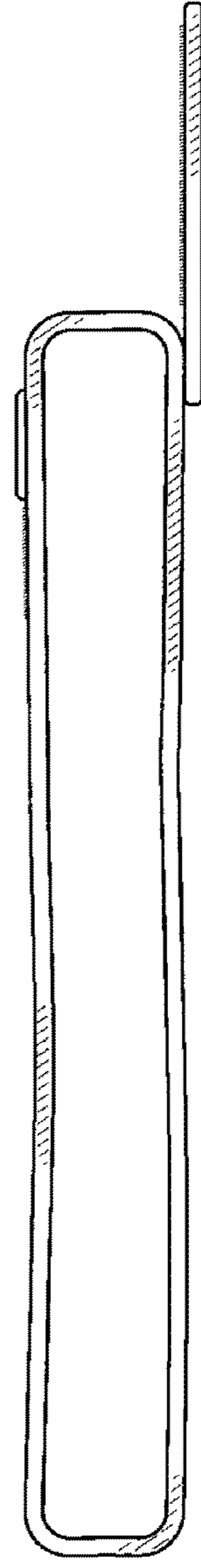

FIG. 6

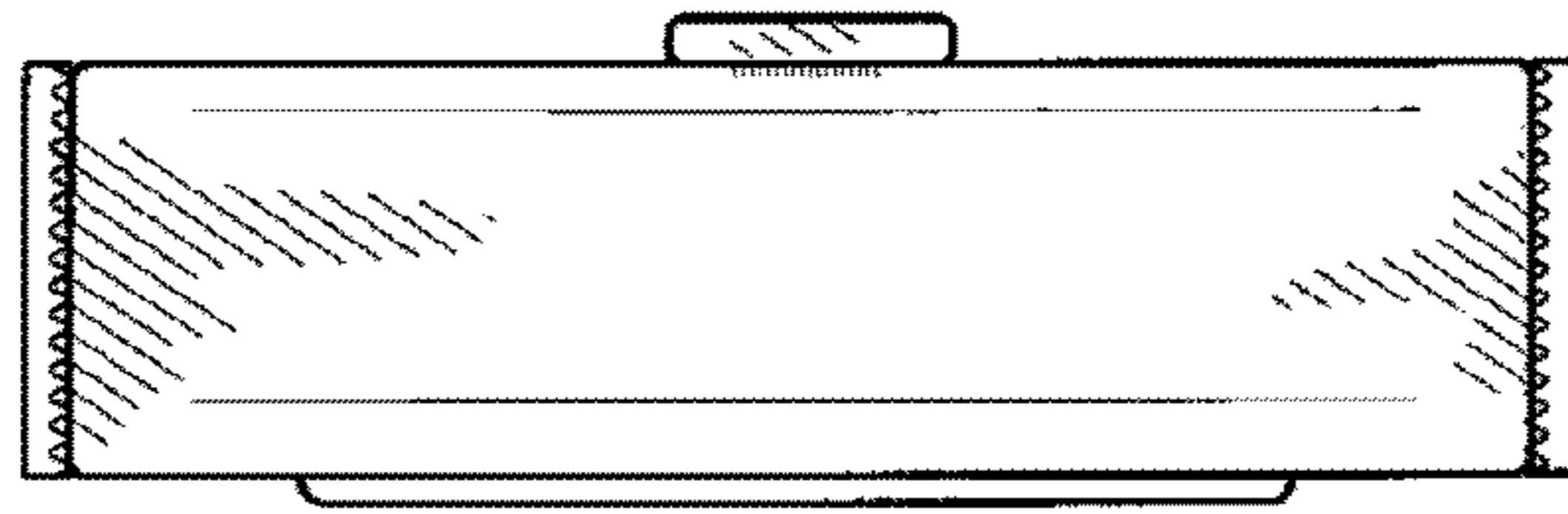

FIG. 7

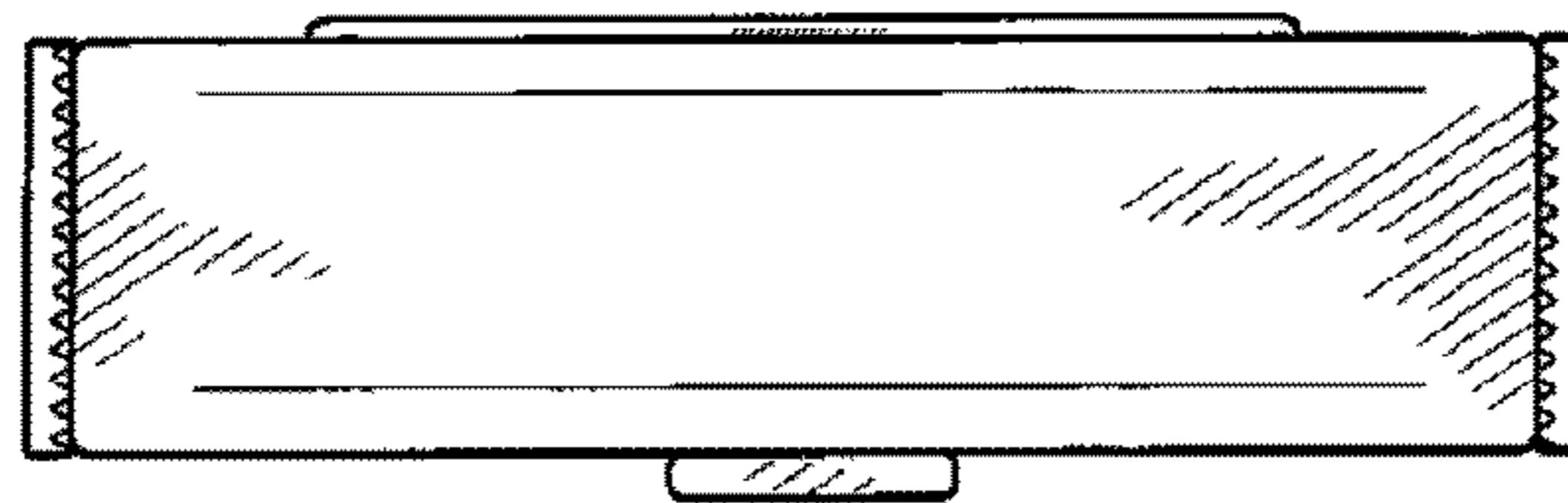

FIG. 8

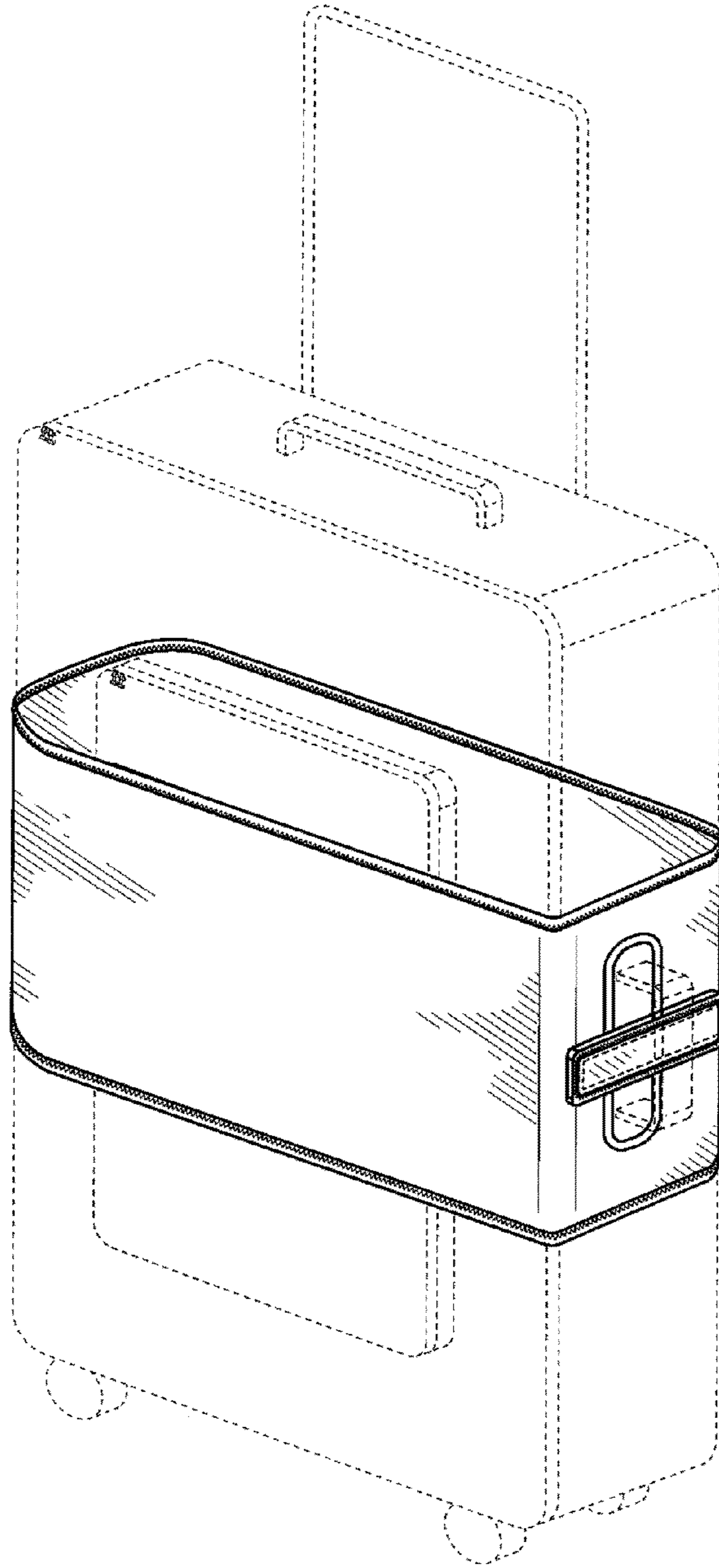

FIG. 9

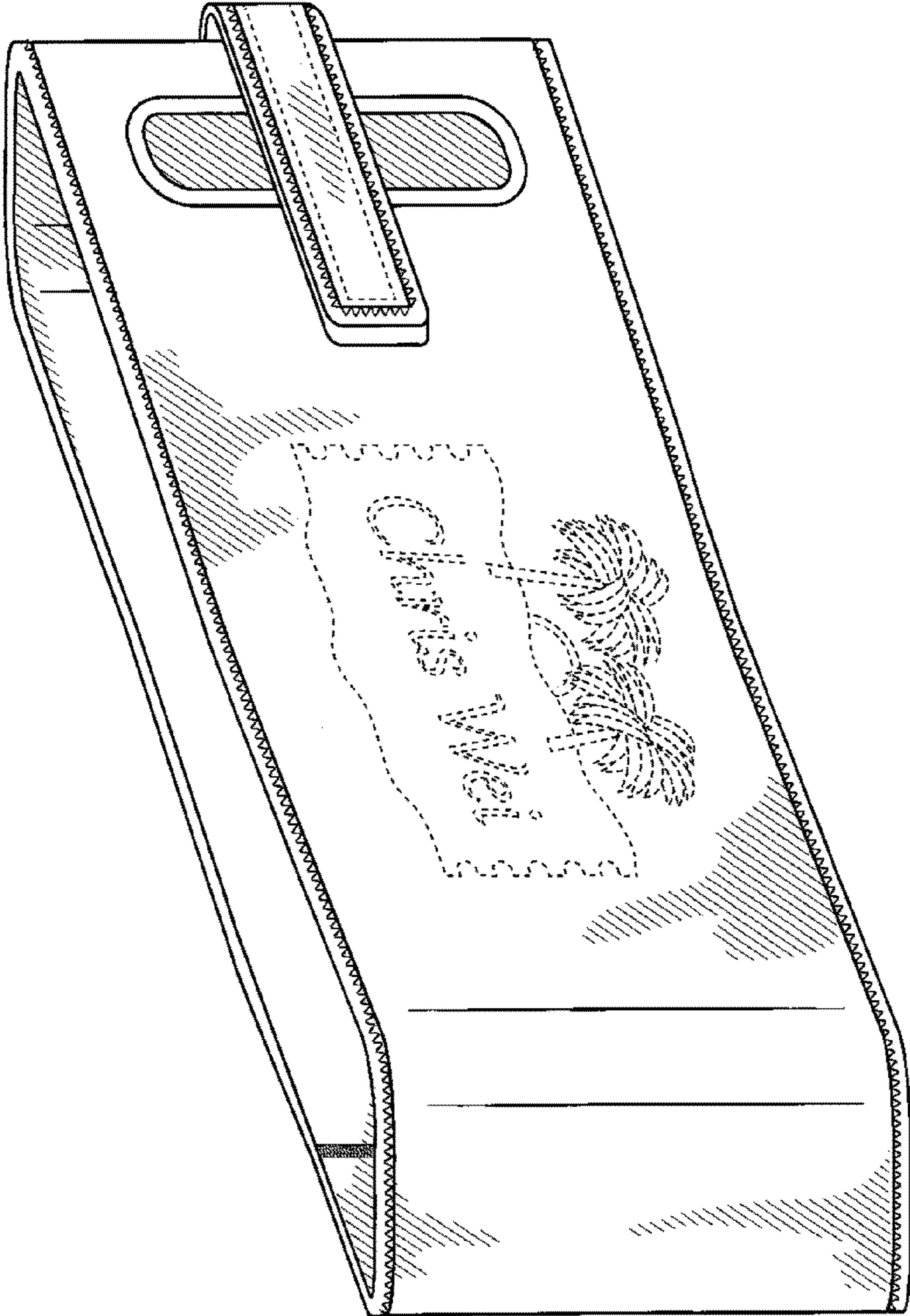

FIG. 10

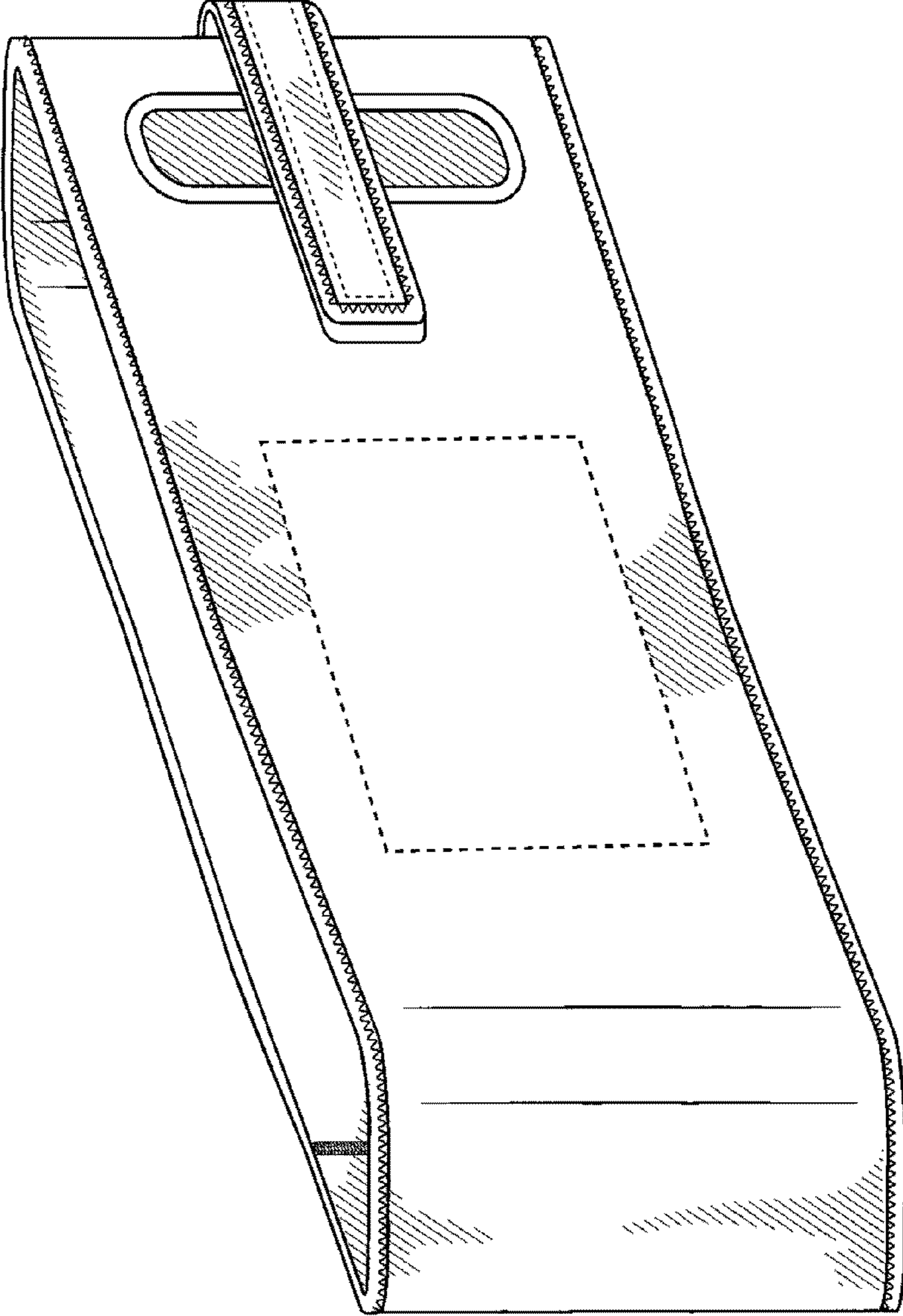

FIG. 11

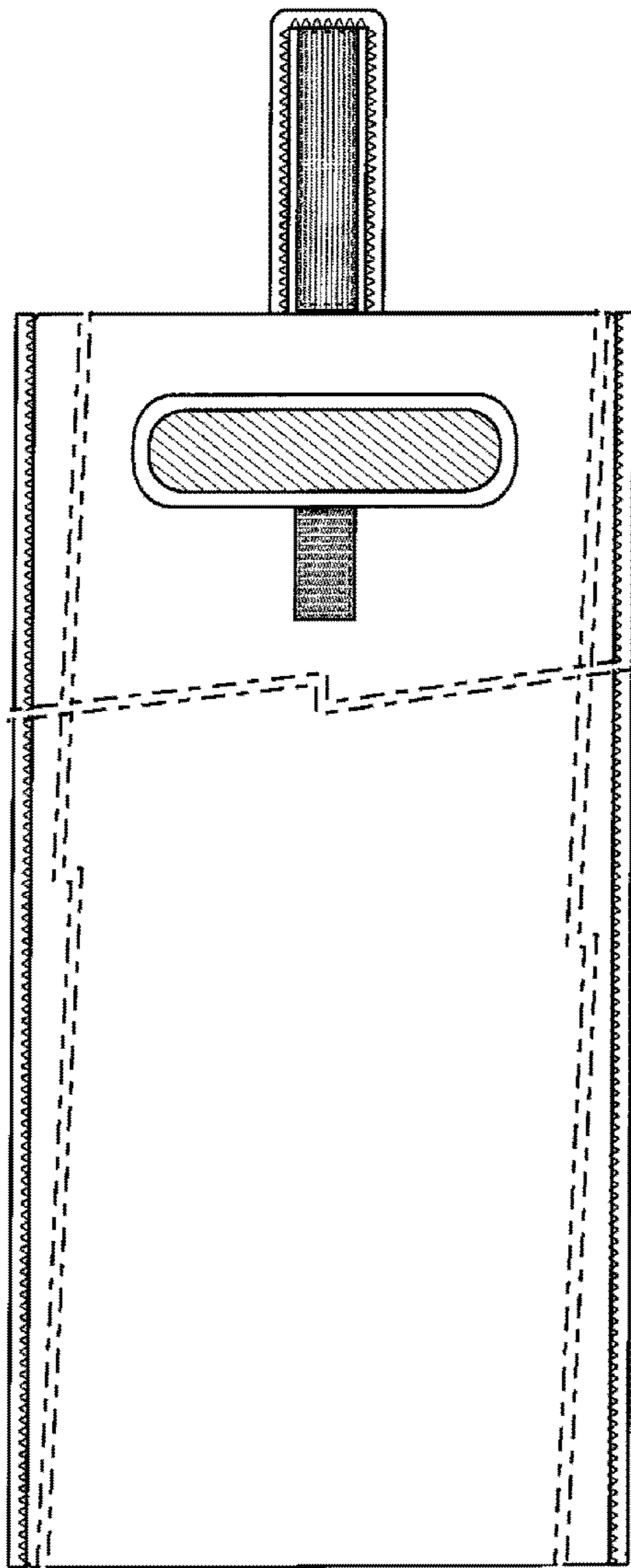

FIG. 12

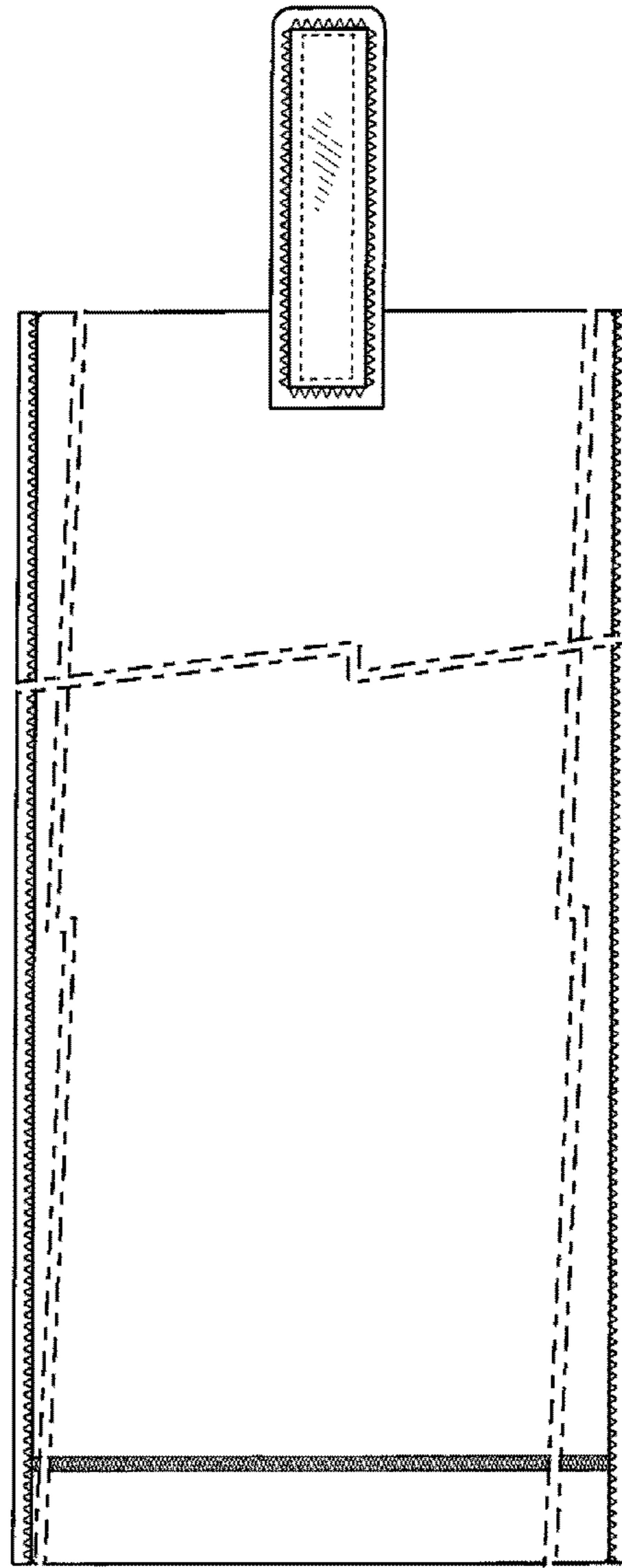

FIG. 13

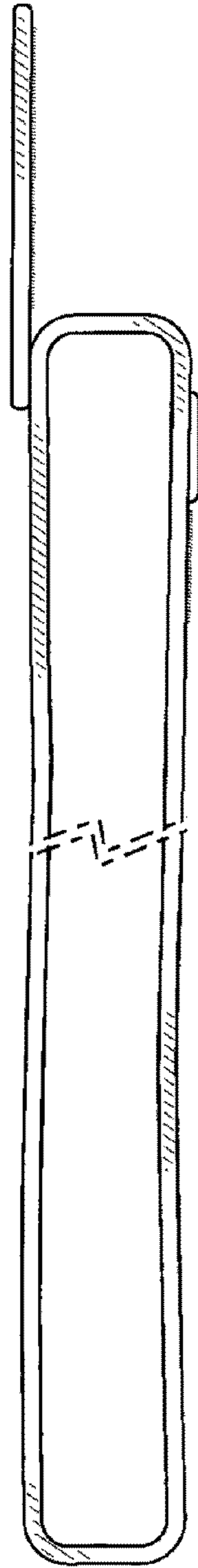

FIG. 14

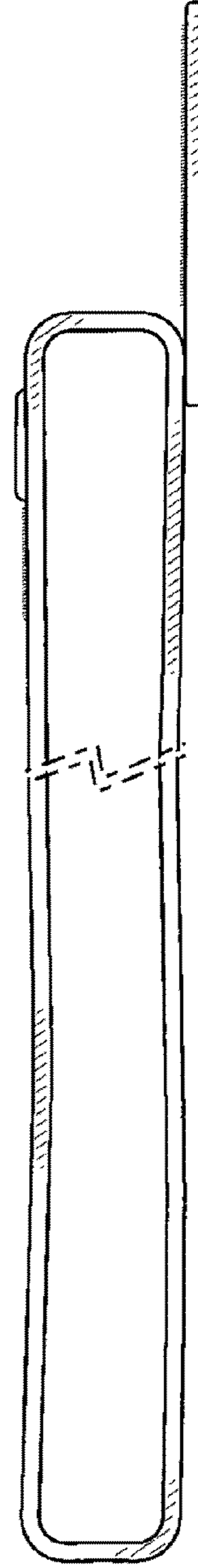

FIG. 15

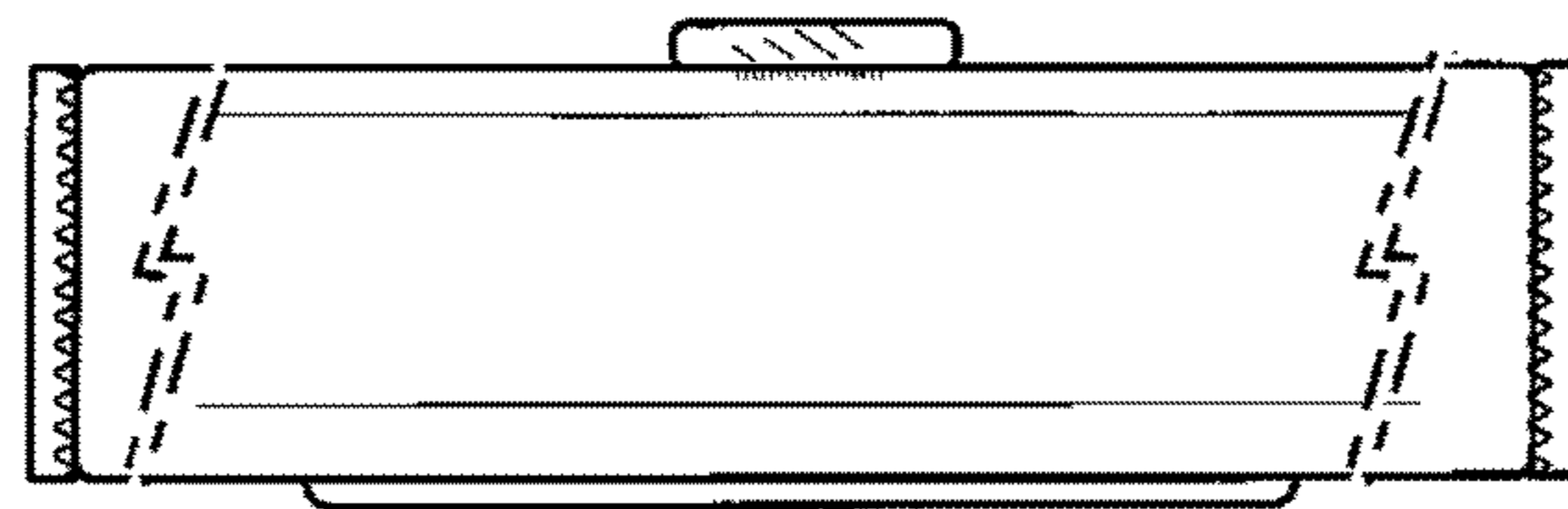

FIG. 16

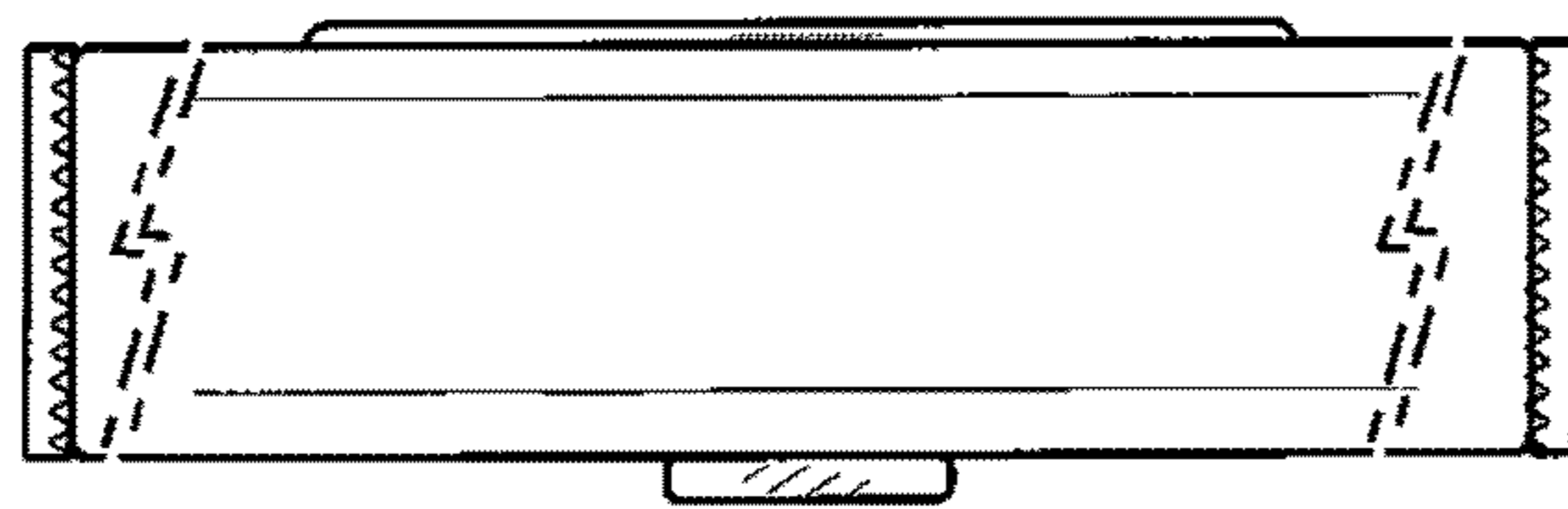

FIG. 17