



US00D755486S

(12) **United States Design Patent**  
**Gavrieli et al.**

(10) **Patent No.:** **US D755,486 S**

(45) **Date of Patent:** **\*\* \*May 10, 2016**

(54) **SINGLE-SOLE SHOE WITH STRIPE, SOLE,  
AND CONTRASTING UPPER**

1,525,848 A *	2/1925	Bonaventure	.....	36/8.3
1,587,377 A	6/1926	Grosjean		
1,650,466 A	11/1927	Righter		
2,224,590 A	12/1940	Odilon		
2,268,777 A	1/1942	Scholl		

(Continued)

(71) Applicant: **Gavrieli Brands LLC**, Beverly Hills,  
CA (US)

(72) Inventors: **Kfir Gavrieli**, Los Angeles, CA (US);  
**Dikla Gavrieli**, Los Angeles, CA (US)

FOREIGN PATENT DOCUMENTS

(73) Assignee: **Gavrieli Brands LLC**, Beverly Hills,  
CA (US)

DE	20 2006 000230 U1	5/2007
GB	2443937 A	5/2008

(Continued)

(\*) Notice: This patent is subject to a terminal disclaimer.

OTHER PUBLICATIONS

(\*\*) Term: **14 Years**

Examination Report for AU 341324, 3 pgs., dated Oct. 24, 2012.

(Continued)

(21) Appl. No.: **29/489,814**

*Primary Examiner* — Dominic Simone

(22) Filed: **May 2, 2014**

(74) *Attorney, Agent, or Firm* — Morgan, Lewis & Bockius LLP

(51) **LOC (10) Cl.** ..... **02-04**

(52) **U.S. Cl.**

USPC ..... **D2/939**

(58) **Field of Classification Search**

USPC ..... D2/896, 900, 919-921, 925, 939, 947,  
D2/950, 969, 971; 36/1, 83, 8.1-8.3, 9 R,  
36/45-58, 104, 108, 76 R

CPC ..... A43B 21/00; A43B 21/02; A43B 21/06;  
A43B 9/14; A43B 1/0045; A43B 13/10;  
A43B 13/12; A43B 23/06; A43B 23/07;  
A43B 1/0036

See application file for complete search history.

(57) **CLAIM**

The ornamental design for a single-sole shoe with stripe, sole, and contrasting upper, as shown and described.

**DESCRIPTION**

FIG. 1 is a perspective view of a single-sole shoe with stripe, sole, and contrasting upper, where the portions of the upper that contrast with the sole and stripe are indicated by cross-hatch shading, showing our new design;

FIG. 2 is a first side view thereof;

FIG. 3 is a second side view thereof;

FIG. 4 is a top view thereof;

FIG. 5 is a bottom view thereof;

FIG. 6 is a front view thereof; and,

FIG. 7 is a back view thereof.

The broken lines illustrating the channel on the sole in the above described Figures are for illustrative purposes only and form no part of the claimed design.

(56) **References Cited**

U.S. PATENT DOCUMENTS

249,086 A	11/1881	Pienovi
773,850 A	11/1904	Cooper et al.
830,941 A	9/1906	Walden
1,208,209 A	12/1916	Prince
1,214,666 A	2/1917	Ford
1,519,009 A	12/1924	Reina

**1 Claim, 6 Drawing Sheets**

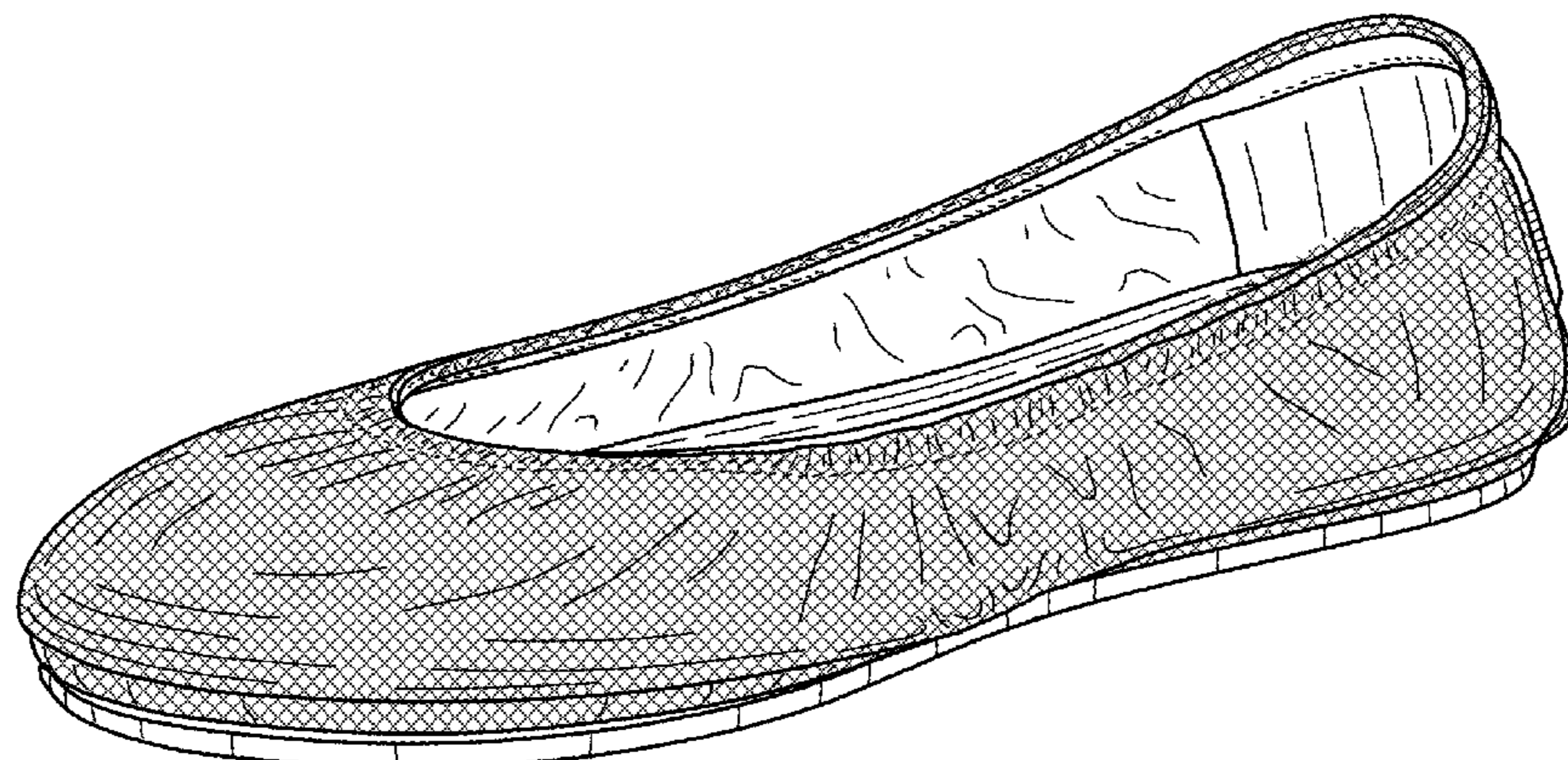

(56)

References Cited

U.S. PATENT DOCUMENTS

D133,819 S *	9/1942	Harris	D2/939	7,735,244 B1	6/2010	Ameche
D135,791 S	6/1943	Beebe		7,743,530 B2	6/2010	Truelsen
2,323,563 A	7/1943	Nugent		D618,891 S	7/2010	McClaskie
2,342,882 A	2/1944	Meltzer		7,757,408 B2	7/2010	McClaskie
D141,871 S	7/1945	Braun		D630,829 S	1/2011	Weisner
2,383,585 A	8/1945	Bindner		D632,881 S	2/2011	Rosenberg
D149,685 S *	5/1948	Sandler	D2/935	7,926,203 B2	4/2011	Wilkenfeld
D150,729 S *	8/1948	Sandler	D2/927	7,966,747 B2	6/2011	Wilkenfeld et al.
D166,090 S *	3/1952	Maling	D2/897	D640,861 S	7/2011	Wilkenfeld
2,772,488 A	12/1956	Meltzer		8,020,320 B2	9/2011	Gillespie
2,904,814 A	9/1959	Scholl		8,127,468 B2	3/2012	Morgan
3,148,378 A	9/1964	Tibbitts		D657,543 S	4/2012	Bove
D200,897 S *	4/1965	Mitchell	D2/919	D659,960 S	5/2012	Bizzo
D220,464 S	4/1971	Hayoshi		8,230,619 B2	7/2012	Salvatelli
D247,396 S *	3/1978	Schlerth	D2/939	D664,755 S	8/2012	Gavrieli et al.
4,412,393 A	11/1983	Terlizzi, Jr. et al.		D665,157 S	8/2012	Wu
D275,525 S	9/1984	Nakao		8,240,067 B2	8/2012	Sussmann
4,674,206 A	6/1987	Lyden		8,245,420 B2	8/2012	Wilson
D295,692 S *	5/1988	Zuidema et al.	D2/950	D668,027 S	10/2012	Millieret
D300,085 S	3/1989	Ito et al.		D668,438 S	10/2012	Millieret
RE33,018 E	8/1989	Ostrander		D668,847 S	10/2012	Gavrieli et al.
4,899,412 A	2/1990	Ganon		D668,848 S	10/2012	Gavrieli et al.
D316,773 S	5/1991	Valle		D668,849 S	10/2012	Pozzi
5,012,541 A	5/1991	Ganon		D668,850 S	10/2012	Pozzi
D339,669 S *	9/1993	Miller	D2/919	D672,542 S	12/2012	Gray et al.
5,282,326 A	2/1994	Schroer, Jr. et al.		D676,634 S	2/2013	Gavrieli et al.
5,421,050 A	6/1995	Laganas		D681,927 S	5/2013	Gavrieli
5,699,629 A	12/1997	Munschy		D681,928 S	5/2013	Gavrieli
5,746,014 A	5/1998	Tanemoto		D681,929 S	5/2013	Gavrieli
D420,785 S	2/2000	Perez		D683,936 S	6/2013	Gavrieli
6,055,745 A	5/2000	Endoh		8,468,723 B2	6/2013	Malka-Harari
6,076,284 A	6/2000	Terlizzi		8,510,975 B2	8/2013	Krikelis
6,189,239 B1	2/2001	Gasparovic et al.		D688,853 S	9/2013	Gavrieli
6,338,207 B1	1/2002	Chang		D688,855 S	9/2013	Gavrieli
D457,292 S *	5/2002	Sessa	D2/949	D689,270 S	9/2013	Gavrieli
D461,947 S	8/2002	Merceron		D689,271 S	9/2013	Gavrieli
D476,798 S	7/2003	Reynolds et al.		D689,272 S	9/2013	Gavrieli
6,588,124 B2	7/2003	Morrone		D690,914 S	10/2013	Gavrieli
D498,041 S	11/2004	McClaskie		D690,915 S	10/2013	Gavrieli
D500,191 S *	12/2004	Belley et al.	D2/969	D696,500 S	12/2013	Hunt
D501,706 S	2/2005	McClaskie		D699,424 S	2/2014	Hamm
6,857,203 B2	2/2005	Minden		8,661,714 B2	3/2014	Sussmann
6,895,693 B2	5/2005	Baruck		8,973,287 B2	3/2015	Shibata
6,978,557 B2	12/2005	Lee		2002/0078591 A1	6/2002	Morrone
7,032,327 B1	4/2006	Tartaglia et al.		2002/0129519 A1	9/2002	Cahan
7,036,244 B1	5/2006	Finch		2003/0070319 A1	4/2003	Minden
D527,513 S *	9/2006	Della Valle	D2/919	2003/0121176 A1	7/2003	Baruck
D529,513 S	10/2006	Aketa		2004/0025377 A1	2/2004	Brannon
D531,790 S	11/2006	Wurzburg		2005/0022421 A1	2/2005	Bruckner
D534,341 S *	1/2007	Choi	D2/971	2005/0115115 A1	6/2005	Lacey
D542,513 S	5/2007	Amado et al.		2005/0217148 A1	10/2005	Connolly et al.
D556,990 S	12/2007	Cabados		2005/0262734 A1	12/2005	Cheng
7,337,558 B2	3/2008	Terlizzi et al.		2006/0086005 A1	4/2006	Yerian
D567,485 S	4/2008	James		2006/0156576 A1	7/2006	Sloan
D570,488 S	6/2008	Kirksey et al.		2007/0074424 A1	4/2007	Lin
D571,084 S	6/2008	Comeau		2007/0204482 A1	9/2007	Gibson-Collinson
D571,548 S	6/2008	Seamans		2007/0204483 A1	9/2007	Kirsch et al.
D571,989 S	7/2008	Siegal		2008/0052964 A1	3/2008	Taylor
D580,640 S	11/2008	Wurzburg		2008/0086912 A1	4/2008	Wilkenfeld
D582,638 S	12/2008	Ringholz		2008/0110059 A1	5/2008	Kuramoto et al.
7,496,982 B2	3/2009	Clark et al.		2009/0019732 A1	1/2009	Sussmann
7,506,459 B2	3/2009	Grisoni et al.		2009/0193685 A1	8/2009	Wilson
D591,031 S	4/2009	Cofinco		2009/0205222 A1	8/2009	Mclinden
D593,295 S *	6/2009	Belley et al.	D2/969	2009/0272009 A1	11/2009	Weisner et al.
D593,297 S *	6/2009	Belley et al.	D2/969	2010/0011625 A1	1/2010	Percival
D593,307 S *	6/2009	Belley et al.	D2/969	2010/0018080 A1	1/2010	Smith
D599,093 S *	9/2009	Issler	D2/971	2010/0050469 A1	3/2010	Chen
D604,030 S	11/2009	Wilson		2010/0095557 A1	4/2010	Jarvis
D607,194 S	1/2010	Zagula		2010/0115793 A1	5/2010	Kraisosky
D610,332 S	2/2010	Raichle		2010/0122475 A1	5/2010	Purrrington
D610,785 S	3/2010	Smith		2010/0146822 A1	6/2010	MacGregor
D612,140 S	3/2010	Moon		2010/0212186 A1	8/2010	Cheng
D612,141 S	3/2010	Moon		2010/0275462 A1	11/2010	Pucci
7,694,435 B1	4/2010	Kiser et al.		2010/0281713 A1	11/2010	Pantazes
D615,737 S	5/2010	Feller		2015/0089843 A1	4/2015	Gavrieli

(56)

**References Cited**

## U.S. PATENT DOCUMENTS

## FOREIGN PATENT DOCUMENTS

GB	2 446 205 A	8/2008
TW	D119165	10/2007

## OTHER PUBLICATIONS

Letter from TMI and Associates with Office Action, 2 pgs, dated Sep. 19, 2012 <http://www.payless.com/store/?&TLC=Womens&SLC=WomensNewArrivals>

&BLC=WomensNewArrivalsNewArrivals&With+Regular  
&ItemCode=60131&LotNumber=062642&Type=Adult  
&Popularity=637&Descriptvein.

Taiwanese Office Action for TW 101300726, 10 pgs., dated Sep. 6, 2012.

“The Love List, Tiefs by Gavrieli—Foldable Ballet Flats,” <http://thelovelist-carly.blogspot.com.au/2010/09/tiefs-by-gavrieli-foldable-ballet.html>, 3 pgs., Sep. 12, 2010.

“Tiefs by Gavrieli,” <http://tiefs.com>, 1 pg., retrieved Mar. 13, 2013 from URL.

“Try It Mummy!, Tiefs by Gavrieli,” <http://tryitmummy.blogspot.com.au/2010/12/tiefs-by-gavrieli.html>, 4 pgs., Dec. 9, 2010.

“Wearability—Real People Style, What came first, the City Flat or the Tiefs,” <http://wearability.posterous.com/what-came-first-the-city-flat-or-the-tiefs>, 4 pgs., Aug. 29, 2010.

“The Ballet Flat . . . Reinvented; Ballet Flats . . . with a Bonus; Step Into Tiefs; Going Places? Take Tiefs,” <http://web.archive.org/web/2010052004346/http://www.tiefs.com/>; 4 pgs., May 24, 2010.

“Tiefs—Comfortable designer flats you can fit in your purse and wear all day, every day,” <http://web.archive.org/web/20110731151555/http://tiefs.com/>; 6 pgs., Jul. 31, 2011.

“58th Annual Emmy Awards,” [http://spoonsforksandfashion.blogspot.com/2006\\_08\\_01\\_archive.html](http://spoonsforksandfashion.blogspot.com/2006_08_01_archive.html), depicting Nine West flats, 11 pgs., Aug. 1, 2006.

Pictures of Nine West flats sold in 2006, 3 pgs.

“I Love a Good Ballet Flat!,” <http://dressupfiles.com/i-love-a-good-ballet-flat>, depicting Sue London flats, 4 pgs., Sep. 3, 2010.

Pictures of Sue London flats sold in 2010, 2 pgs.

“Miss Cathie Reviews: The Yosi Samra Foldable Ballet Flat . . .,” <http://www.misscathie.com/2010/01/miss-cathie-reviews-the-yosi-samra-foldable-ballet-flat/>, depicting Yosi Samra flats, 7 pgs., Jan. 2010.

Pictures of Yosi Samra flats sold in 2010, 2 pgs.

“Goodbye two thousand ten,” [http://emmajoyrussell.blogspot.com/2010\\_12\\_01\\_archive.html](http://emmajoyrussell.blogspot.com/2010_12_01_archive.html), depicting Gap flats, 39 pgs., Dec. 1, 2010.

Pictures of Gap flats available for sale in 2010, 9 pgs.

“Our newest design of folding flats—Pink,” <https://fitinclouds.wordpress.com/2010/05/16/our-newest-design-of-folding-flats-pink/>, depicting Fit in Clouds flats, 1 pg., May 16, 2010.

“Fit in Clouds Satin Folding Shoes,” <http://www.goodhousekeeping.com/product-reviews/clothing/best-ballet-flats/fit-in-clouds-satin-foldable-ballet-flats>, depicting Fit in Clouds flats, 1 pg., Aug. 2013.

Pictures of Fit in Clouds flats available for sale in 2011, 4 pgs.

“Shoes for Standing,” <https://truthinshoes.wordpress.com/2008/07/depicting-sam-libby-flats>, 2 pgs., Jul. 31, 2008.

“Target Designer Collaboration: Announcing Sam & Libby Shoes for Target,” <http://www.therecessionista.com/2012/11/target-designer-collaboration-announcing-sam-libby-shoes-for-target.html>, depicting Sam & Libby flats, 1 pg., Nov. 26, 2012.

Pictures of Sam & Libby flats available for purchase in 2011, 5 pgs.

“Save your soles with Citisoles ballet flats,” <http://glamazondiaries.com/2009/07/save-your-soles-with-citisoles-ballet-flats>, depicting Citisoles flats, 3 pgs., Jul. 2009.

Pictures of Citisoles flats available for purchase in 2009, 3 pgs.

“#16 Corso Como Delicious Pumps Review and Giveaway!,” <http://www.mommatoldmeblog.com/2011/01/16-corso-como-delicious-pumps-review.html>, depicting Corso Como flats, 8 pgs., Jan. 16, 2011.

Pictures of Corso Como flats available for sale in 2011, 3 pgs.

“jil-sander-navy-lead-ballet-flats-product . . .,” [www.ebay.com](http://www.ebay.com), depicting Jil Sander flats, 4 pgs., Nov. 2013.

Pictures of Jil Sander flats available for sale in 2011, 3 pgs.

“Spare Soles: Shoes That Roll-up & Fold-up,” <http://herpackinglist.com/2011/01/spare-soles-shoes/>, depicting Spare Soles flats, 2 pgs., Jan. 2011.

Pictures of Spare Soles flats available for sale in 2011, 5 pgs.

The Original Rollable, Foldable ballet flats with matching wristlet—Spare Soles, <http://herpackinglist.com/2011/01/spare-soles-shoes/>, depicting Roll-Upz Spare Soles flats, 2 pgs., Jan. 2011.

Pictures of Roll-Upz by Spare Soles flats available for sale in 2011, 6 pgs.

“The Cutest Blog, Preppy 50 and Loving Lilly, Ballet Flat Delight,” <http://preppy50andlovinglilly.blogspot.com/2011/02/ballet-flat-delight.html>, depicting Henri Bendel flats, 13 pgs., Feb. 19, 2011.

Pictures of Henri Bendel flats available for sale in 2011, 4 pgs.

“Mumsnet by parents for parents,” [http://www.mumsnet.com/Talk/style\\_and\\_beauty/a1612000-Anyone-tried-Redfoot-Flatmates-foldable-ballet-pumps](http://www.mumsnet.com/Talk/style_and_beauty/a1612000-Anyone-tried-Redfoot-Flatmates-foldable-ballet-pumps), depicting Redfoot Flatmates flats, 1 pg, Nov. 14, 2012.

Pictures of Redfoot Flatmates flats available for sale in 2011, 6 pgs.

“Amazon.com: Customer Reviews: Bloch London Women’s Lux Ballet Flat,” <http://www.amazon.com/Bloch-London-Womens-Ballet-Flat/product-reviews/B004LWP7YW>, depicting Bloch London flats, 4 pgs., Dec. 11, 2011.

Pictures of Bloch London flats offered for sale in 2011, 11 pgs.

“h&m foldable leopard print flat,” <http://845shops.wordpress.com/2011/06/16/flats-for-7-bucks-shoe1/>, depicting h&m flats, 3 pgs., Jun. 16, 2011.

Pictures of h&m foldable flats offered for sale in 2011, 4 pgs.

“Seekyt—Juicy Couture Ballet Flats—Are They Worth the Money?,” <http://seekyt.com/juicy-couture-ballet-flats-are-they-worth-the-money/>, 14 pgs., Jun. 3, 2011.

Pictures of Juicy Couture flats offered for sale in 2011, 3 pgs.

“Purse Flats,” <http://purseflats.wordpress.com>, depicting Purse Flats by Erica Wilson, 3 pgs., Jul. 12, 2012.

Pictures of Purse Flats by Erica Wilson offered for sale in 2011, 6 pgs.

“Splash Page,” <http://web.archive.org/web/20100524004346/http://www.tiefs.com/>, 4 pgs., May 24, 2010.

“Tiefs—Comfortable, designer flats you can fit in your purse and wear all day, every day,” <http://web.archive.org/web/20110731151555/http://tiefs.com/>, 6 pgs., Jul. 31, 2011.

“Tiefs by Gavrieli—Comfortable, designed flats you can fit in your purse and wear all day . . .,” <http://web.archive.org/web/20110202210649/http://www.tiefs.com>, 8 pgs., Feb. 2, 2011.

“Carolina M. M. Gonzalez > Tiefs by Gavrieli,” [http://m2.facebook.com/Tiefs?v=timeline&filter=2&timecutoff=1406427986&page=17&sectionLoadingID=m\\_timeline\\_loading\\_div\\_1293868799\\_1262332800\\_8\\_17&timeend=1293868799&timestart=1262332800&tm=AQDOvqhWQPN\\_Nbwm&refid=17](http://m2.facebook.com/Tiefs?v=timeline&filter=2&timecutoff=1406427986&page=17&sectionLoadingID=m_timeline_loading_div_1293868799_1262332800_8_17&timeend=1293868799&timestart=1262332800&tm=AQDOvqhWQPN_Nbwm&refid=17), 1 pg. Jan. 26, 2010.

“The Shoes Oprah Would Wear to Work (if She Had to Walk),” <http://www.inc.com/30under30/christina-desmarais/kfir-gavrieli-and-elram-gavrieli-founders-of-tiefs.html>, 8 pgs., Jul. 2, 2012.

“Tiefs by Gavrieli,” [http://m2.facebook.com/Tiefs?v=timeline&filter=2&timecutoff=1406427986&page=14&sectionLoadingID=m\\_timeline\\_loading\\_div\\_1293868799\\_1262332800\\_8\\_14&timeend=1293868799&timestart=1262332800](http://m2.facebook.com/Tiefs?v=timeline&filter=2&timecutoff=1406427986&page=14&sectionLoadingID=m_timeline_loading_div_1293868799_1262332800_8_14&timeend=1293868799&timestart=1262332800)

&tm=AQDOvqhWQPN\_Nbwm&refid=17, 4 pgs., Jan. 26, 2010.

“Mighty Life List, Sensible Shoes,” <http://mightygirl.com/2010/08/24/sensible-shoes/>, 10 pgs., Aug. 24, 2010.

“Find! Tiefs: Fab & sexy flats for fall,” <http://thefabmom.com/2013/08/29/find-tiefs-fab-sexy-flats-for-fall/>, 3 pgs. Aug. 29, 2013.

“Step into Tiefs,” <http://sliceofpink.typepad.com/blog/2010/09/tiefs-1.html>, 5 pgs., Sep. 22, 2010.

“In Need of Flat-Soled Shoes,” <http://sliceofpink.typepad.com/blog/2010/09/tiefs-1.html>, 7 pgs., Oct. 3, 2010.

\* cited by examiner

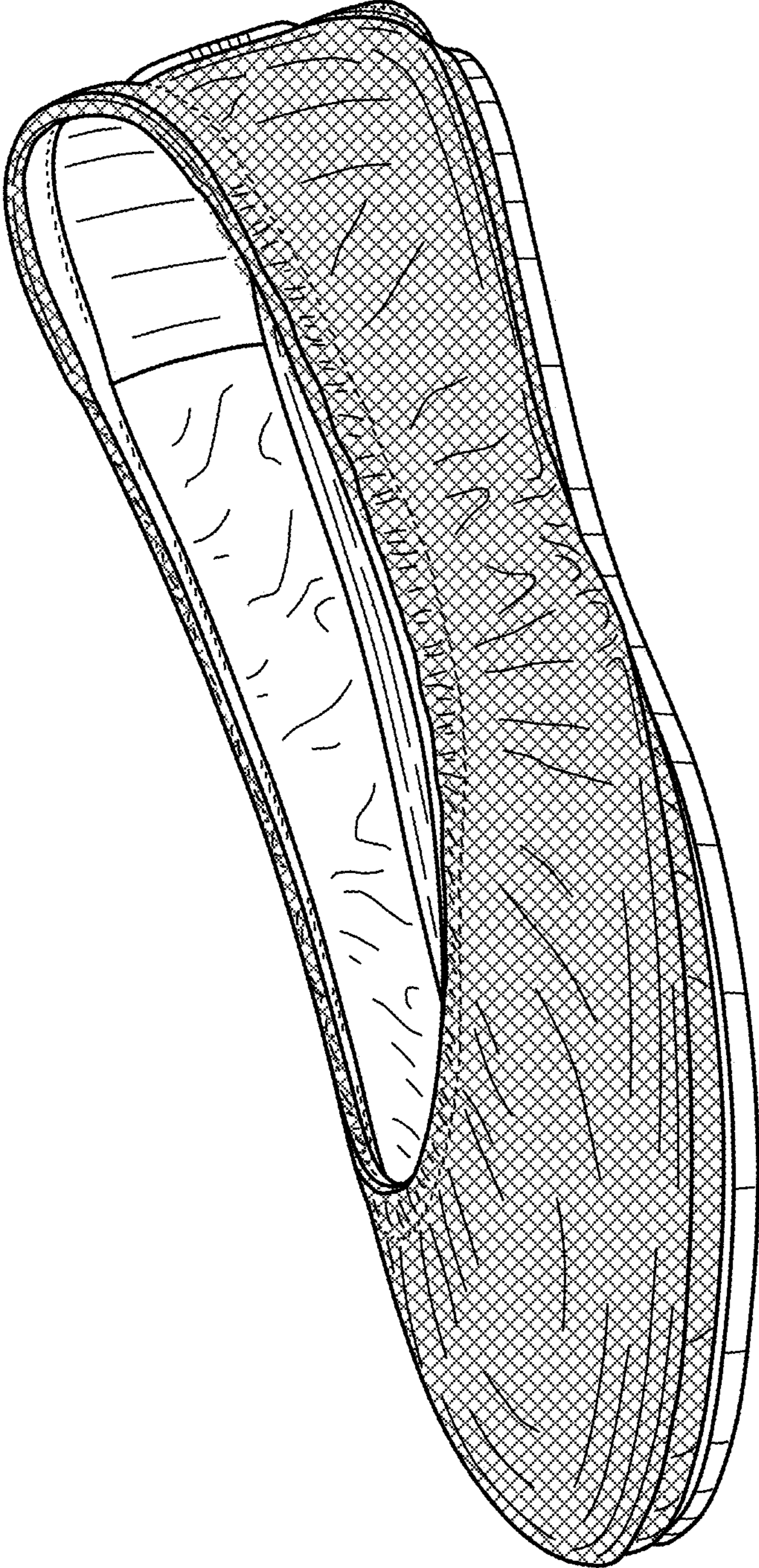

FIG. 1

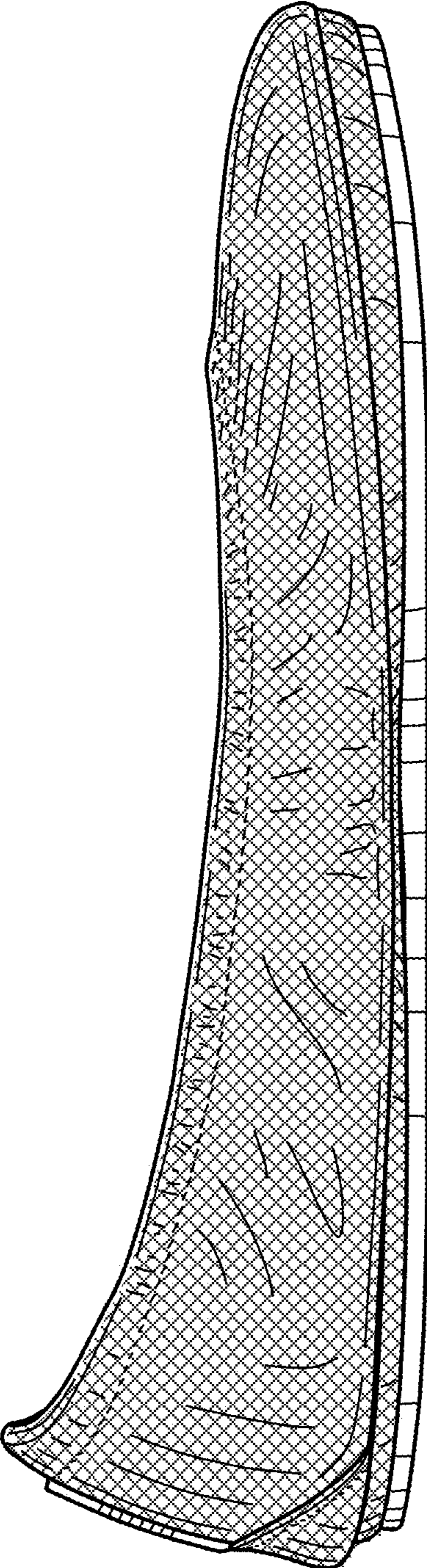

FIG. 2

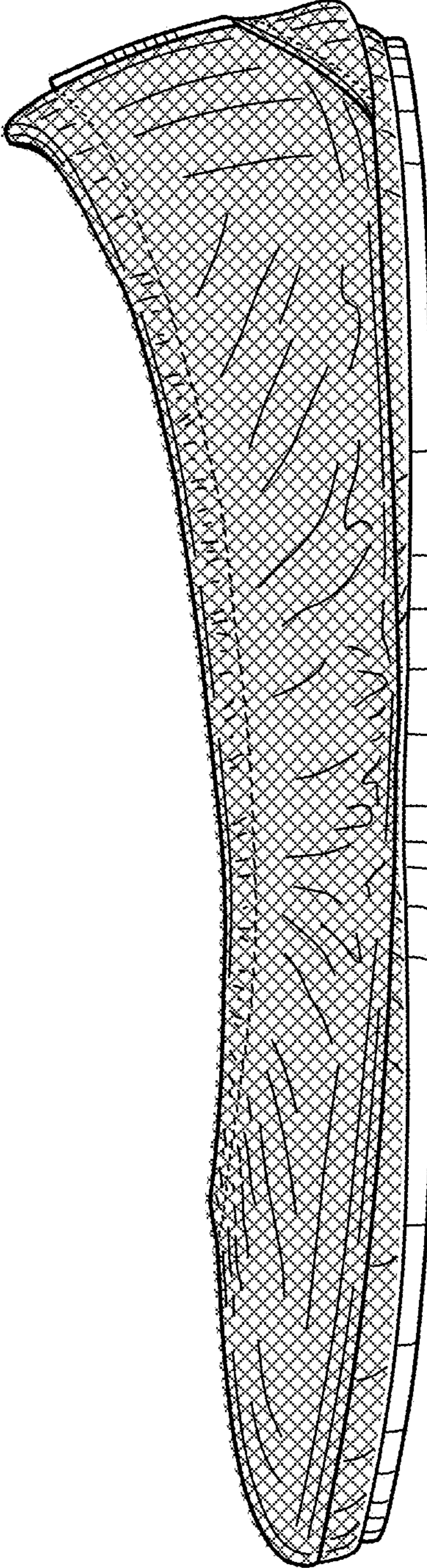

FIG. 3

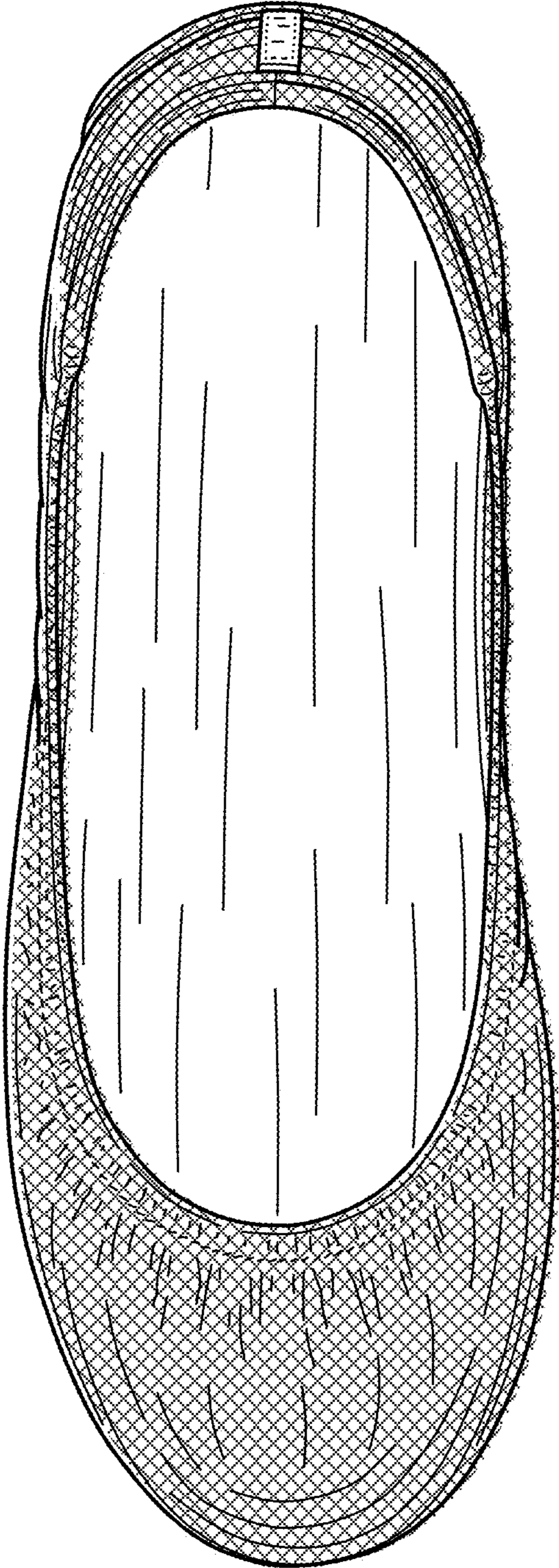

FIG. 4

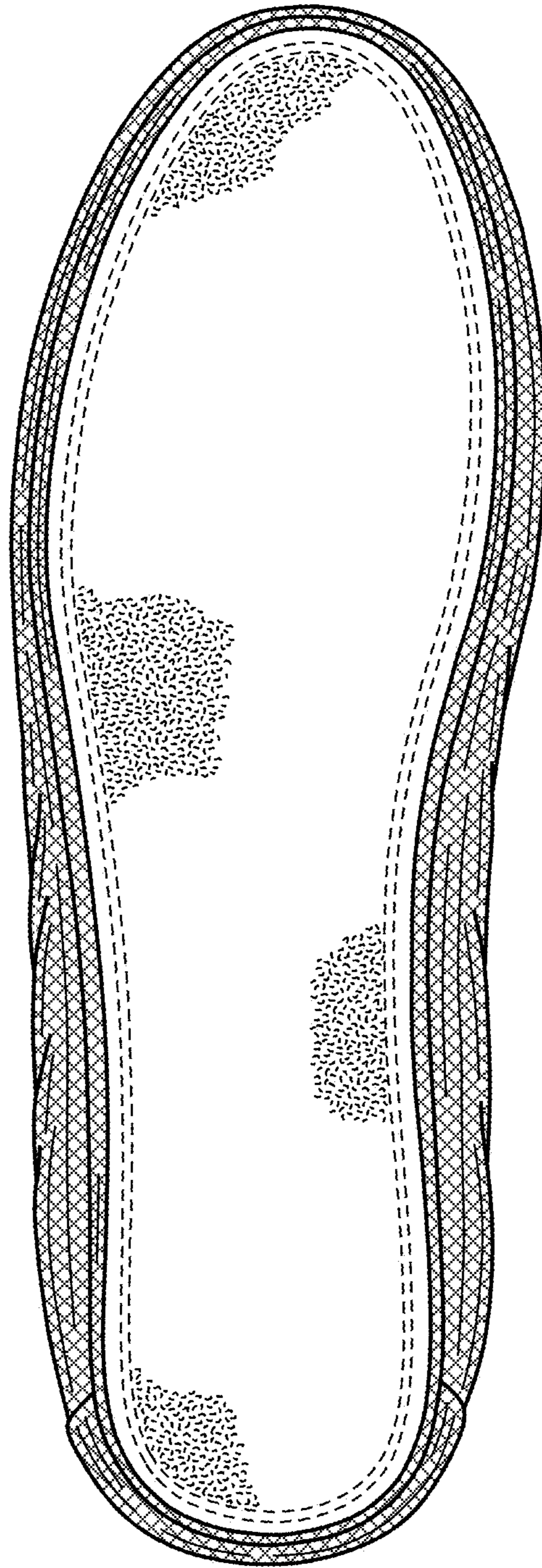

FIG. 5



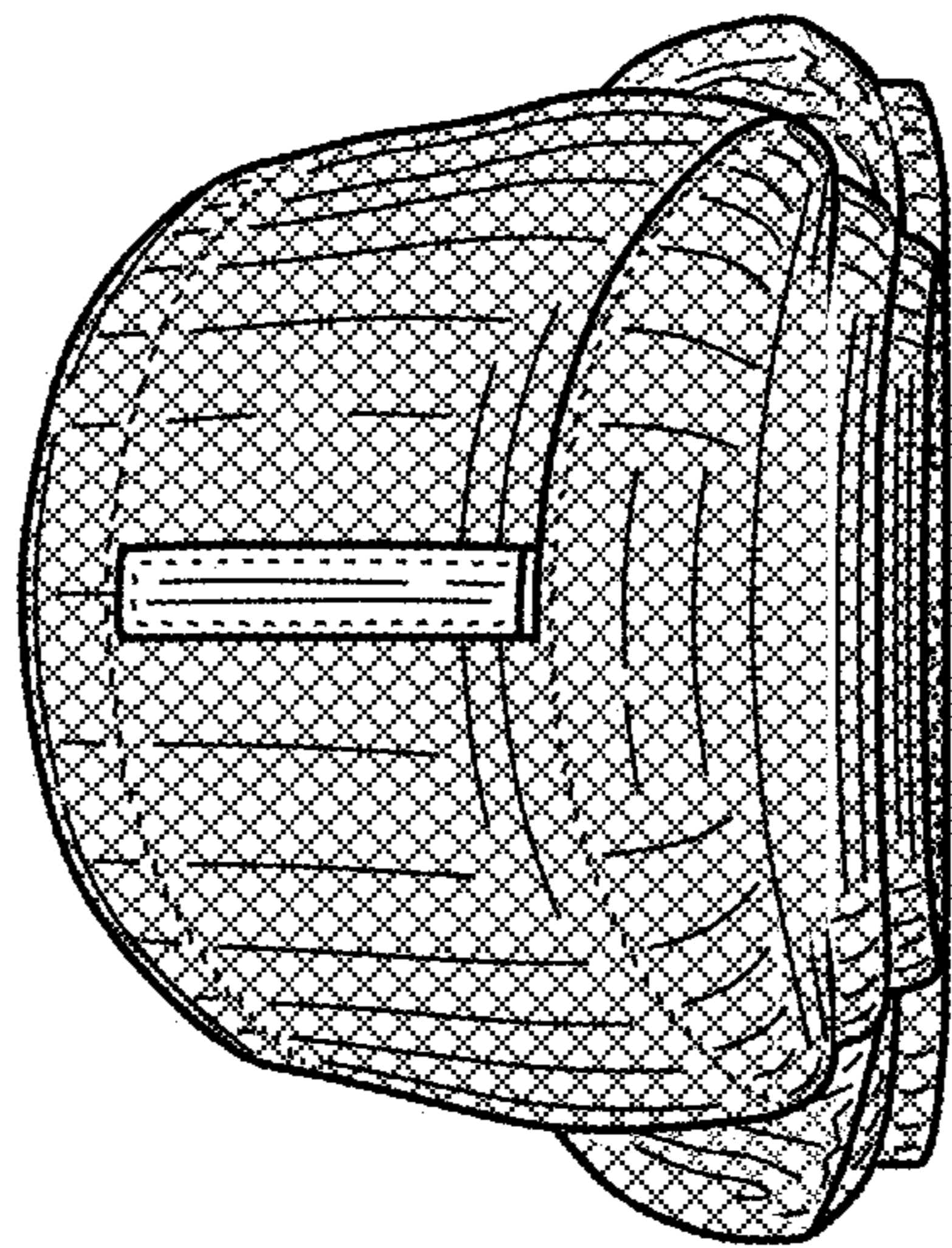

FIG. 7

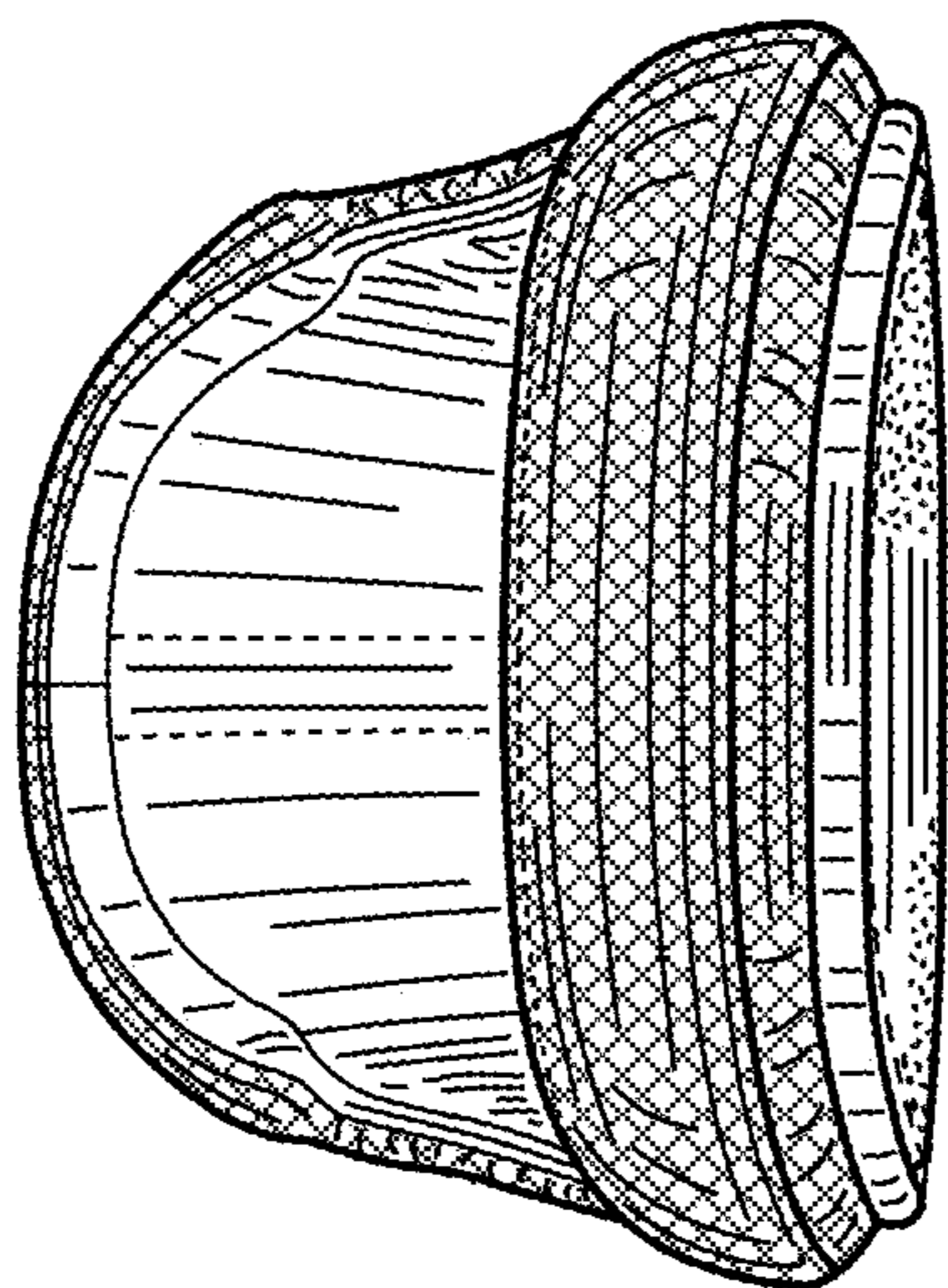

FIG. 6