



US00D755485S

(12) **United States Design Patent**  
**Gavrieli et al.**

(10) **Patent No.:** **US D755,485 S**

(45) **Date of Patent:** **\*\* \*May 10, 2016**

(54) **SINGLE-SOLE SHOE WITH BLUE SOLE AND CONTRASTING UPPER**

(71) Applicant: **Gavrieli Brands LLC**, Beverly Hills, CA (US)

(72) Inventors: **Kfir Gavrieli**, Los Angeles, CA (US);  
**Dikla Gavrieli**, Los Angeles, CA (US)

(73) Assignee: **Gavrieli Brands LLC**, Beverly Hills, CA (US)

(\*) Notice: This patent is subject to a terminal disclaimer.

(\*\*) Term: **14 Years**

(21) Appl. No.: **29/489,812**

(22) Filed: **May 2, 2014**

(51) **LOC (10) Cl.** ..... **02-04**

(52) **U.S. Cl.**  
USPC ..... **D2/939**

(58) **Field of Classification Search**  
USPC ..... D2/896, 900, 919-921, 925, 939, 947,  
D2/950, 969, 971; 36/1, 83, 8.1-8.3, 9 R,  
36/45-58, 104, 108, 76 R  
CPC ..... A43B 21/00; A43B 21/02; A43B 21/06;  
A43B 9/14; A43B 1/0045; A43B 13/10;  
A43B 13/12; A43B 23/06; A43B 23/07;  
A43B 1/0036

See application file for complete search history.

(56) **References Cited**

**U.S. PATENT DOCUMENTS**

249,086 A	11/1881	Pienovi	
773,850 A	11/1904	Cooper et al.	
830,941 A	9/1906	Walden	
1,208,209 A	12/1916	Prince	
1,214,666 A	2/1917	Ford	
1,519,009 A	12/1924	Reina	
1,525,848 A *	2/1925	Bonaventure	36/8.3
1,587,377 A	6/1926	Grosjean	
1,650,466 A	11/1927	Righter	

2,224,590 A	12/1940	Odilon	
2,268,777 A	1/1942	Scholl	
D133,819 S *	9/1942	Harris	D2/939
D135,791 S	6/1943	Beebe	
2,323,563 A	7/1943	Nugent	
2,342,882 A	2/1944	Meltzer	
2,383,585 A	8/1945	Bindner	
D149,685 S *	5/1948	Sandler	D2/935
D141,871 S	7/1948	Braun	
D150,729 S *	8/1948	Sandler	D2/927
D166,090 S *	3/1952	Maling	D2/897
2,772,488 A	12/1956	Meltzer	
2,904,814 A	9/1959	Scholl	
3,148,378 A	9/1964	Tibbitts	
D200,897 S *	4/1965	Mitchell	D2/919
D220,464 S	4/1971	Hayoshi	
D247,396 S *	3/1978	Schlerth	D2/939
4,412,393 A	11/1983	Terlizzi, Jr. et al.	
D275,525 S	9/1984	Nakao	
4,674,206 A	6/1987	Lyden	
D295,692 S *	5/1988	Zuidema et al.	D2/950
D300,085 S	3/1989	Ito et al.	
RE33,018 E	8/1989	Ostrander	
4,899,412 A	2/1990	Ganon	
D316,773 S	5/1991	Valle	
5,012,541 A	5/1991	Ganon	
D339,669 S *	9/1993	Miller	D2/919
5,282,326 A	2/1994	Schroer, Jr. et al.	
5,421,050 A	6/1995	Laganas	
5,699,629 A	12/1997	Munschy	
5,746,014 A	5/1998	Tanemoto	
D420,785 S	2/2000	Perez	
6,055,745 A	5/2000	Endoh	
6,076,284 A	6/2000	Terlizzi	
6,189,239 B1	2/2001	Gasparovic et al.	
6,338,207 B1	1/2002	Chang	
D457,292 S *	5/2002	Sessa	D2/949
D461,947 S	8/2002	Merceron	
D476,798 S	7/2003	Reynolds et al.	
6,588,124 B2	7/2003	Morrone	
D498,041 S	11/2004	McClaskie	
D500,191 S *	12/2004	Belley et al.	D2/969
D501,706 S	2/2005	McClaskie	
6,857,203 B2	2/2005	Minden	
6,895,693 B2	5/2005	Baruck	
6,978,557 B2	12/2005	Lee	
7,032,327 B1	4/2006	Tartaglia et al.	
7,036,244 B1	5/2006	Finch	
D527,513 S *	9/2006	Della Valle	D2/919
D529,513 S	10/2006	Aketa	
D531,790 S	11/2006	Wurzberg	
D534,341 S *	1/2007	Choi	D2/971
D542,513 S	5/2007	Amado et al.	

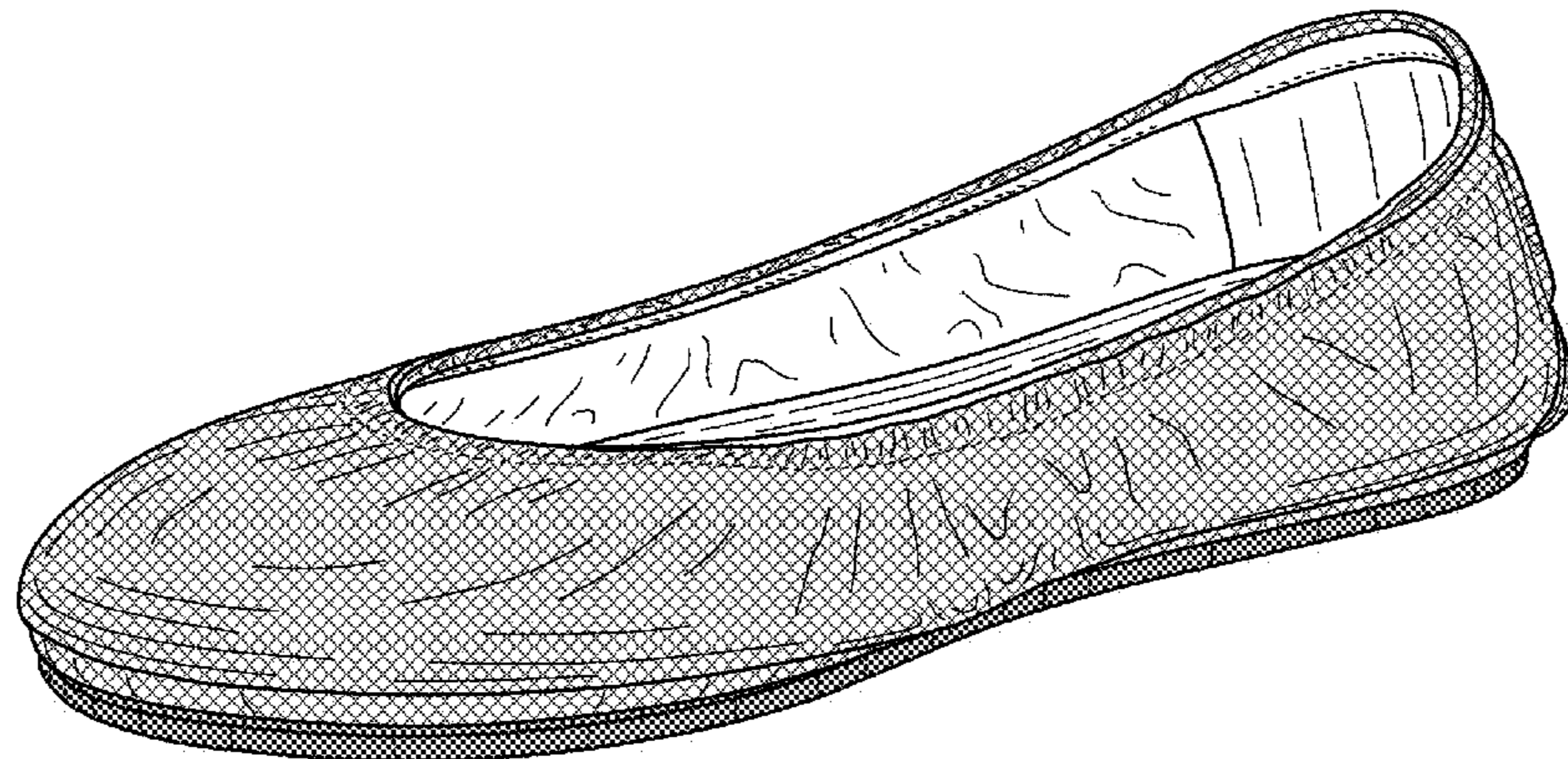

D556,990	S	12/2007	Cabados	
7,337,558	B2	3/2008	Terlizzi et al.	
D567,485	S	4/2008	James	
D570,488	S	6/2008	Kirksey et al.	
D571,084	S	6/2008	Comeau	
D571,548	S	6/2008	Seamans	
D571,989	S	7/2008	Siegal	
D580,640	S	11/2008	Wurzburg	
D582,638	S	12/2008	Ringholz	
7,496,982	B2	3/2009	Clark et al.	
7,506,459	B2	3/2009	Grisoni et al.	
D591,031	S	4/2009	Cofinco	
D593,295	S *	6/2009	Belley et al. ....	D2/969
D593,297	S *	6/2009	Belley et al. ....	D2/969
D593,307	S *	6/2009	Belley et al. ....	D2/969
D599,093	S *	9/2009	Issler .....	D2/971
D604,030	S	11/2009	Wilson	
D607,194	S	1/2010	Zagula	
D610,332	S	2/2010	Raichle	
D610,785	S	3/2010	Smith	
D612,140	S	3/2010	Moon	
D612,141	S	3/2010	Moon	
7,694,435	B1	4/2010	Kiser et al.	
D615,737	S	5/2010	Feller	
7,735,244	B1	6/2010	Ameche	
7,743,530	B2	6/2010	Truelsen	
D618,891	S	7/2010	McClaskie	
7,757,408	B2	7/2010	McClaskie	
D630,829	S	1/2011	Weisner	
D632,881	S	2/2011	Rosenberg	
7,926,203	B2	4/2011	Wilkenfeld	
7,966,747	B2	6/2011	Wilkenfeld et al.	
D640,861	S	7/2011	Wilkenfeld	
8,020,320	B2	9/2011	Gillespie	
8,127,468	B2	3/2012	Morgan	
D657,543	S	4/2012	Bove	
D659,960	S	5/2012	Bizzo	
8,230,619	B2	7/2012	Salvatelli	
D664,755	S	8/2012	Gavrieli et al.	
D665,157	S	8/2012	Wu	
8,240,067	B2	8/2012	Sussmann	
8,245,420	B2	8/2012	Wilson	
D668,027	S	10/2012	Millieret	
D668,438	S	10/2012	Millieret	
D668,847	S	10/2012	Gavrieli et al.	
D668,848	S	10/2012	Gavrieli et al.	
D668,849	S	10/2012	Pozzi	
D668,850	S	10/2012	Pozzi	
D672,542	S	12/2012	Gray et al.	
D676,634	S	2/2013	Gavrieli et al.	
D681,927	S	5/2013	Gavrieli	
D681,928	S	5/2013	Gavrieli	
D681,929	S	5/2013	Gavrieli	
D683,936	S	6/2013	Gavrieli	
8,468,723	B2	6/2013	Malka-Harari	
8,510,975	B2	8/2013	Krikelis	
D688,853	S	9/2013	Gavrieli	
D688,855	S	9/2013	Gavrieli	
D689,270	S	9/2013	Gavrieli	
D689,271	S	9/2013	Gavrieli	
D689,272	S	9/2013	Gavrieli	
D690,914	S	10/2013	Gavrieli	
D690,915	S	10/2013	Gavrieli	
D696,500	S	12/2013	Hunt	
D699,424	S	2/2014	Hamm	
8,661,714	B2	3/2014	Sussmann	
8,973,287	B2	3/2015	Shibata	
2002/0078591	A1	6/2002	Morrone	
2002/0129519	A1	9/2002	Cahan	
2003/0070319	A1	4/2003	Minden	
2003/0121176	A1	7/2003	Baruck	
2004/0025377	A1	2/2004	Brannon	
2005/0022421	A1	2/2005	Bruckner	
2005/0115115	A1	6/2005	Lacey	
2005/0217148	A1	10/2005	Connolly et al.	
2005/0262734	A1	12/2005	Cheng	
2006/0086005	A1	4/2006	Yerian	
2006/0156576	A1	7/2006	Sloan	
2007/0074424	A1	4/2007	Lin	

2007/0204482	A1	9/2007	Gibson-Collinson
2007/0204483	A1	9/2007	Kirsch et al.
2008/0052964	A1	3/2008	Taylor
2008/0086912	A1	4/2008	Wilkenfeld
2008/0110059	A1	5/2008	Kuramoto et al.
2009/0019732	A1	1/2009	Sussmann
2009/0193685	A1	8/2009	Wilson
2009/0205222	A1	8/2009	McLinden
2009/0272009	A1	11/2009	Weisner et al.
2010/0011625	A1	1/2010	Percival
2010/0018080	A1	1/2010	Smith
2010/0050469	A1	3/2010	Chen
2010/0095557	A1	4/2010	Jarvis
2010/0115793	A1	5/2010	Kraisosky
2010/0122475	A1	5/2010	Purrrington
2010/0146822	A1	6/2010	MacGregor
2010/0212186	A1	8/2010	Cheng
2010/0275462	A1	11/2010	Pucci
2010/0281713	A1	11/2010	Pantazes
2015/0089843	A1	4/2015	Gavrieli

FOREIGN PATENT DOCUMENTS

DE	20 2006 00023	U1	5/2007
GB	2443937	A	5/2008
GB	2 446 205	A	8/2008
TW	D119165		10/2007

OTHER PUBLICATIONS

Examination Report for AU 341324, 3 pgs., dated Oct. 24, 2012.  
 Letter from TMI and Associates with Office Action, 2 pgs, dated Sep. 19, 2012 <http://www.payless.com/store/?&TLC=Womens&SLC=WomensNewArrivals&BLC=WomensNewArrivalsNewArrivals&With+Regular&ItemCode=60131&LotNumber=062642&Type=Adult&Popularity=637&Descriptvein>.  
 Taiwanese Office Action for TW 101300726, 10 pgs., dated Sep. 6, 2012.  
 “The Love List, Tiefs by Gavrieli—Foldable Ballet Flats,” <http://thelovelist-carly.blogspot.com.au/2010/09/tiefs-by-gavrieli-foldable-ballet.html>, 3 pgs., Sep. 12, 2010.  
 “Tiefs by Gavrieli,” <http://tiefs.com>, 1 pg., retrieved Mar. 13, 2013 from URL.  
 “Try It Mummy!, Tiefs by Gavrieli, ” <http://tryitmummy.blogspot.com.au/2010/12/tiefs-by-gavrieli.html>, 4 pgs., Dec. 9, 2010.  
 “Wearability— Real People Style, What came first, the City Flat or the Tiefs,” <http://wearability.posterous.com/what-came-first-the-city-flat-or-the-tiefs>, 4 pgs., Aug. 29, 2010.  
 “The Ballet Flat . . . Reinvented; Ballet Flats . . . with a Bonus; Step Into Tiefs; Going Places? Take Tiefs,” <http://web.archive.org/web/2010052004346/http://www.tiefs.com/>; 4 pgs., May 24, 2010.  
 “Tiefs—Comfortable designer flats you can fit in your purse and wear all day, every day,” <http://web.archive.org/web/20110731151555/http://tiefs.com/>; 6 pgs., Jul. 31, 2011.  
 “58th Annual Emmy Awards,” [http://spoonsforksandfashion.blogspot.com/2006\\_08\\_01\\_archive.html](http://spoonsforksandfashion.blogspot.com/2006_08_01_archive.html), depicting Nine West flats, 11 pgs., Aug. 1, 2006.  
 Pictures of Nine West flats sold in 2006, 3 pgs.  
 “I Love a Good Ballet Flat!,” <http://dressupfiles.com/i-love-a-good-ballet-flat>, depicting Sue London flats, 4 pgs., Sep. 3, 2010.  
 Pictures of Sue London flats sold in 2010, 2 pgs.  
 “Miss Cathie Reviews: The Yosi Samra Foldable Ballet Flat . . . ,” <http://www.misscathie.com/2010/01/miss-cathie-reviews-the-yosi-samra-foldable-ballet-flat/>, depicting Yosi Samra flats, 7 pgs., Jan. 2010.  
 Pictures of Yosi Samra flats sold in 2010, 2 pgs.  
 “Goodbye two thousand ten,” [http://emmajoyrussell.blogspot.com/2010\\_12\\_01\\_archive.html](http://emmajoyrussell.blogspot.com/2010_12_01_archive.html), depicting Gap flats, 39 pgs., Dec. 1, 2010.  
 Pictures of Gap flats available for sale in 2010, 9 pgs.  
 “Our newest design of folding flats—Pink,” <https://fitinclouds.wordpress.com/2010/05/16/our-newest-design-of-folding-flats-pink/>, depicting Fit in Clouds flats, 1 pg., May 16, 2010.

“Fit in Clouds Satin Folding Shoes,” <http://www.goodhousekeeping.com/product-reviews/clothing/best-ballet-flats/fit-in-clouds-satin-foldable-ballet-flats>, depicting Fit in Clouds flats, 1 pg., Aug. 2013. Pictures of Fit in Clouds flats available for sale in 2011, 4 pgs.

“Shoes for Standing,” <http://truthinshoes.wordpress.com/2008/07/>, depicting Sam & Libby flats, 2 pgs., Jul. 31, 2008.

“Target Designer Collaboration: Announcing Sam & Libby Shoes for Target,” <http://www.therecessionista.com/2012/11/target-designer-collaboration-announcing-sam-libby-shoes-for-target.html>, depicting Sam & Libby flats, 1 pg., Nov. 26, 2012. Pictures of Sam & Libby flats available for purchase in 2011, 5 pgs.

“Save your soles with Citisoles ballet flats,” <http://glamazondiaries.com/2009/07/save-your-soles-with-citisoles-ballet-flats>, depicting Citisoles flats, 3 pgs., Jul. 2009. Pictures of Citisoles flats available for purchase in 2009, 3 pgs.

“#16 Corso Como Delicious Pumps Review and Giveaway!,” <http://www.mommatoldmeblog.com/2011/01/16-corso-como-delicious-pumps-review.html>, depicting Corso Como flats, 8 pgs., Jan. 16, 2011. Pictures of Corso Como flats available for sale in 2011, 3 pgs.

“Jil-sander-navy-lead-ballet-flats-product . . .,” [www.ebay.com](http://www.ebay.com), depicting Jil Sander flats, 4 pgs., Nov. 2013. Pictures of Jil Sander flats available for sale in 2011, 3 pgs.

“Spare Soles: Shoes That Roll-up & Fold-up,” <http://herpackinglist.com/2011/01/spare-soles-shoes/>, depicting Spare Soles flats, 2 pgs., Jan. 2011. Pictures of Spare Soles flats available for sale in 2011, 5 pgs.

The Original Rollable, Foldable ballet flats with matching wristlet—Spare Soles, <http://herpackinglist.com/2011/01/spare-soles-shoes>, depicting Roll-Upz Spare Soles flats, 2 pgs., Jan. 2011. Pictures of Roll-Upz by Spare Soles flats available for sale in 2011, 6 pgs.

“The Cutest Blog, Preppy 50 and Loving Lilly, Ballet Flat Delight,” <http://preppy50andlovinglilly.blogspot.com/2011/02/ballet-flat-delight.html>, depicting Henri Bendel flats, 13 pgs., Feb. 19, 2011. Pictures of Henri Bendel flats available for sale in 2011, 4 pgs.

“Mumsnet by parents for parents,” [http://www.mumsnet.com/Talk/style\\_and\\_beauty/a1612000-Anyone-tried-Redfoot-Flatmates-foldable-ballet-pumps](http://www.mumsnet.com/Talk/style_and_beauty/a1612000-Anyone-tried-Redfoot-Flatmates-foldable-ballet-pumps), depicting Redfoot Flatmates flats, 1 pg, Nov. 14, 2012. Pictures of Redfoot Flatmates flats available for sale in 2011, 6 pgs.

“Amazon.com: Customer Reviews: Bloch London Women’s Lux Ballet Flat,” <http://www.amazon.com/Bloch-London-Womens-Ballet-Flat/product-reviews/B004LWP7YW>, depicting Bloch London flats, 4 pgs., Dec. 11, 2011. Pictures of Bloch London flats offered for sale in 2011, 11 pgs.

“H&m foldable leopard print flat,” <http://845shops.wordpress.com/2011/06/16/flats-for-7-bucks-shoe1/>, depicting h&m flats, 3 pgs., Jun. 16, 2011. Pictures of h&m foldable flats offered for sale in 2011, 4 pgs.

“Seekyt—Juicy Couture Ballet Flats—Are They Worth the Money?,” <http://seekyt.com/juicy-couture-ballet-flats-are-they-worth-the-money/>, 14 pgs., Jun. 3, 2011. Pictures of Juicy Couture flats offered for sale in 2011, 3 pgs.

“Purse Flats,” <http://purseflats.wordpress.com>, depicting Purse Flats by Erica Wilson, 3 pgs., Jul. 12, 2012. Pictures of Purse Flats by Erica Wilson offered for sale in 2011, 6 pgs.

“Splash Page,” <http://web.archive.org/web/20100524004346/http://www.tieks.com/>, 4 pgs., May 24, 2010. “Tieks—Comfortable, designer flats you can fit in your purse and wear all day, every day,” <http://web.archive.org/web/20110731151555/http://tieks.com>, 6 pgs., Jul. 31, 2011. “Tieks by Gavrieli—Comfortable, designer flats you can fit in your purse and wear all day . . .,” <http://web.archive.org/web/20110202210649/http://www.tieks.com/>, 8 pgs., Feb. 2, 2011. “Carolina M. M. Goncalves > Tieks by Gavrieli,” [http://m2.facebook.com/Tieks?v=timeline&filter=2&timecutoff=1406427986&page=17&sectionLoadingID=m\\_timeline\\_loading\\_div\\_1293868799\\_1262332800\\_8\\_17&timeend=1293868799&timestart=1262332800&tm=AQDOvqhWQPN\\_Nbwm&refid=17](http://m2.facebook.com/Tieks?v=timeline&filter=2&timecutoff=1406427986&page=17&sectionLoadingID=m_timeline_loading_div_1293868799_1262332800_8_17&timeend=1293868799&timestart=1262332800&tm=AQDOvqhWQPN_Nbwm&refid=17), 1 pg. Jan. 26, 2010.

“The Shoes Oprah Would Wear to Work (if She Had to Walk),” <http://www.inc.com/30under30/christina-desmarais/kfir-gavrieli-and-elram-gavrieli-founders-of-tieks.html>, 8 pgs., Jul. 2, 2012. “Tieks by Gavrieli,” [http://m2.facebook.com/Tieks?v=timeline&filter=2&timecutoff=1406427986&page=14&sectionLoadingID=m\\_timeline\\_loading\\_div\\_1293868799\\_1262332800\\_8\\_14&timeend=1293868799&timestart=1262332800&tm=AQDOvqhWQPN\\_Nbwm&refid=17](http://m2.facebook.com/Tieks?v=timeline&filter=2&timecutoff=1406427986&page=14&sectionLoadingID=m_timeline_loading_div_1293868799_1262332800_8_14&timeend=1293868799&timestart=1262332800&tm=AQDOvqhWQPN_Nbwm&refid=17), 4 pgs., Jan. 26, 2010. “Mighty Life List, Sensible Shoes,” <http://mightygirl.com/2010/08/24/sensible-shoes/>, 10 pgs., Aug. 24, 2010. “Find! Tieks: Fab & sexy flats for fall,” <http://thefabmom.com/2013/08/29/find-tieks-fab-sexy-flats-for-fall/>, 3 pgs. Aug. 29, 2013. “Step in Tieks,” <http://sliceofpink.typepad.com/blog/2010/09/tieks-1.html>, 5 pgs., Sep. 22, 2010. “In Need of Flat-Soles Shoes,” <http://sliceofpink.typepad.com/blog/2010/09/tieks-1.html>, 7 pgs., Oct. 3, 2010.

\* cited by examiner

*Primary Examiner* — Dominic Simone

(74) *Attorney, Agent, or Firm* — Morgan, Lewis & Bockius LLP

(57)

#### CLAIM

The ornamental design for a single-sole shoe with blue sole and contrasting upper, as shown and described.

#### DESCRIPTION

The file of this patent contains at least one drawing executed in color. Copies of this patent with color drawing(s) will be provided by the Office upon request and payment of the necessary fee.

FIG. 1 is a perspective view of an embodiment of our new design of a single-sole shoe with blue sole and contrasting upper, where the portions of the upper that contrast with the sole are indicated by cross-hatch shading;

FIG. 2 is a first side view thereof;

FIG. 3 is a second side view thereof;

FIG. 4 is a top view thereof;

FIG. 5 is a bottom view thereof;

FIG. 6 is a front view thereof;

FIG. 7 is a back view thereof;

FIG. 8 is a perspective view of another embodiment of our new design of a single-sole shoe with blue sole and contrasting upper of FIG. 1, where the blue portions are indicated using the USPTO convention of horizontal lines for blue, and where the portions of the upper that contrast with the sole are indicated by cross-hatch shading;

FIG. 9 is a first side view thereof;

FIG. 10 is a second side view thereof;

FIG. 11 is a top view thereof;

FIG. 12 is a bottom view thereof;

FIG. 13 is a front view thereof; and

FIG. 14 is a back view thereof.

FIG. 15 is a perspective view of yet another embodiment of our new design of a single-sole shoe with blue sole and contrasting upper of FIG. 1, where the blue portions are indicated using a repeated wavy line pattern to indicate the blue color Pantone 7466C, and where the portions of the upper that contrast with the sole are indicated by cross-hatch shading;

FIG. **16** is a first side view thereof;  
FIG. **17** is a second side view thereof;  
FIG. **18** is a top view thereof;  
FIG. **19** is a bottom view thereof;  
FIG. **20** is a front view thereof; and,  
FIG. **21** is a back view thereof.

The broken lines illustrating the channel on the blue sole in the above described Figures are for illustrative purposes only and form no part of the claimed design.

**1 Claim, 18 Drawing Sheets**  
**(5 of 18 Drawing Sheet(s) Filed in Color)**

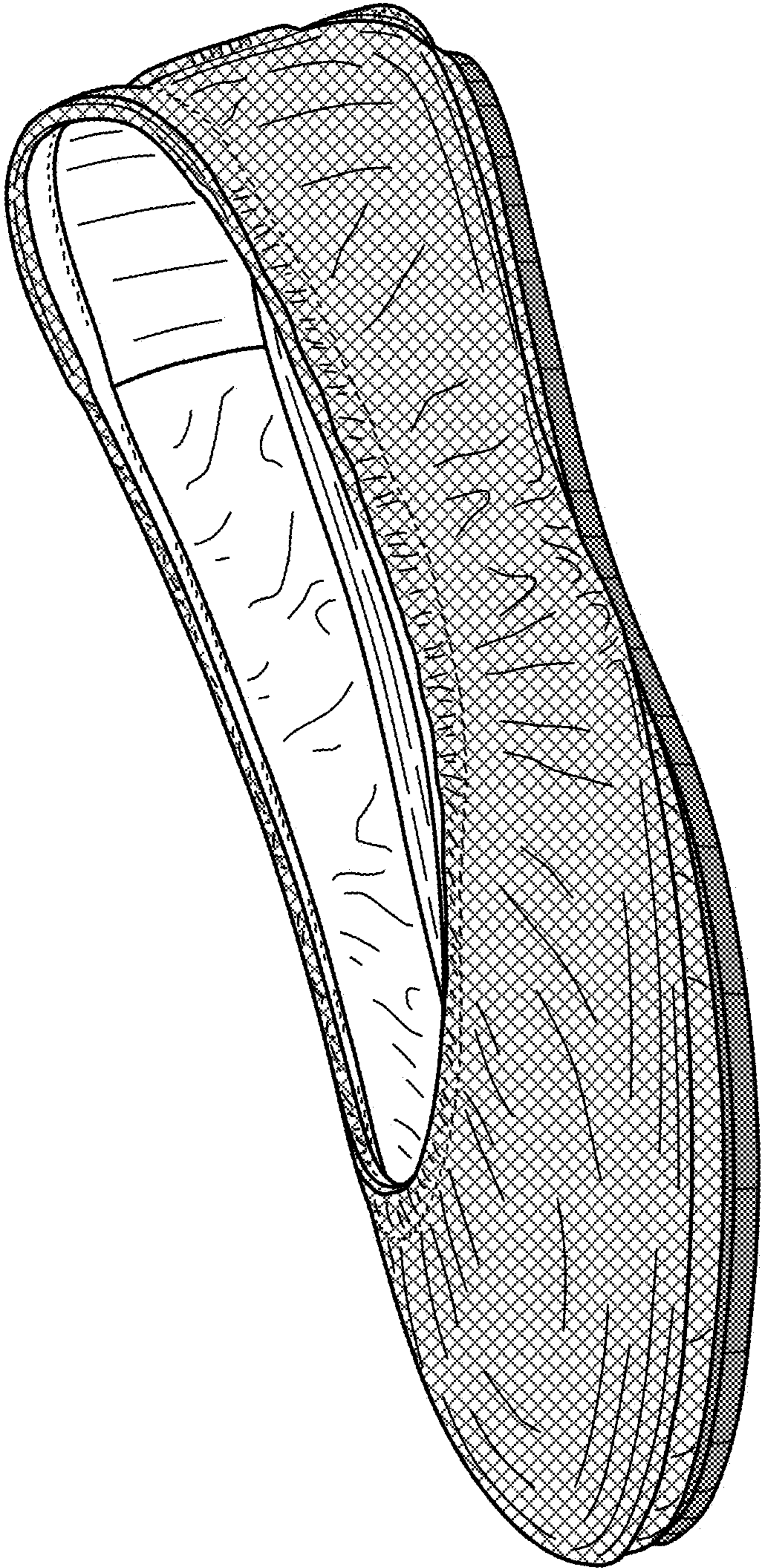

FIG. 1

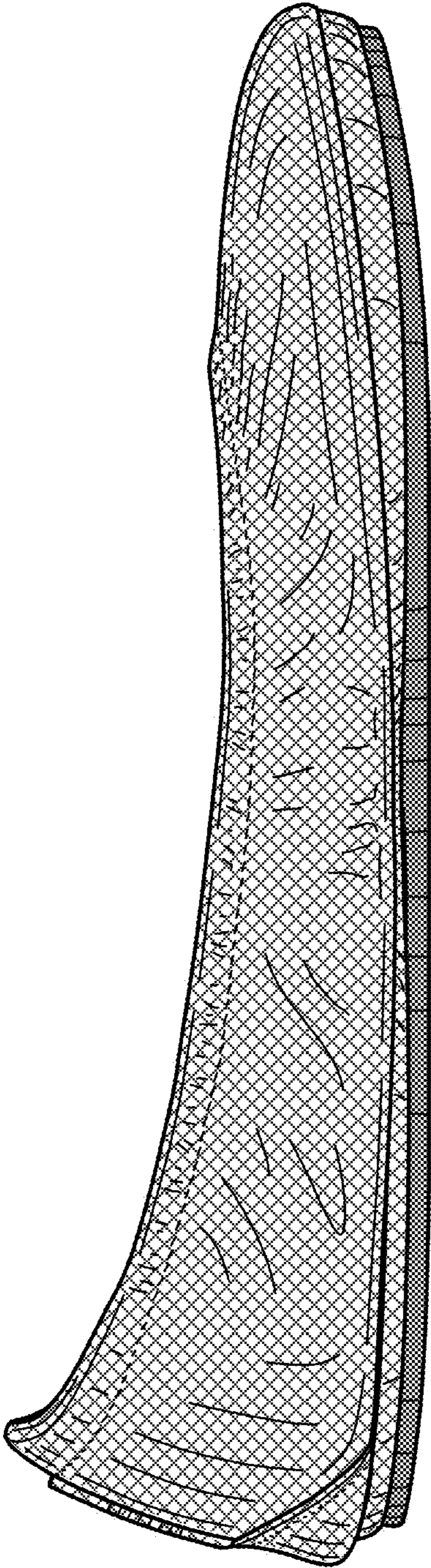

FIG. 2

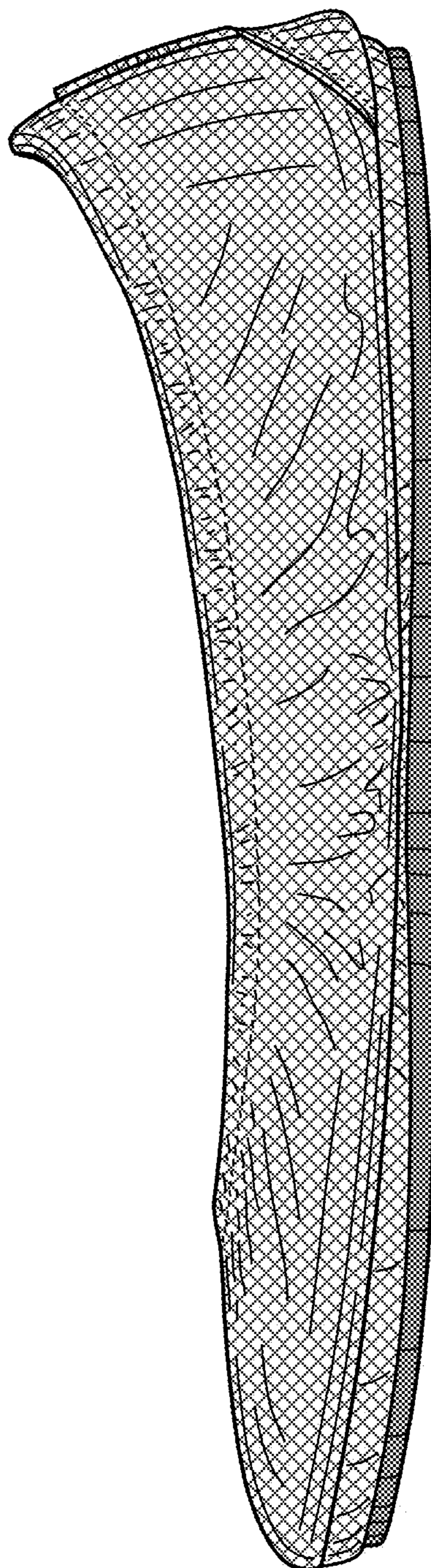

FIG. 3

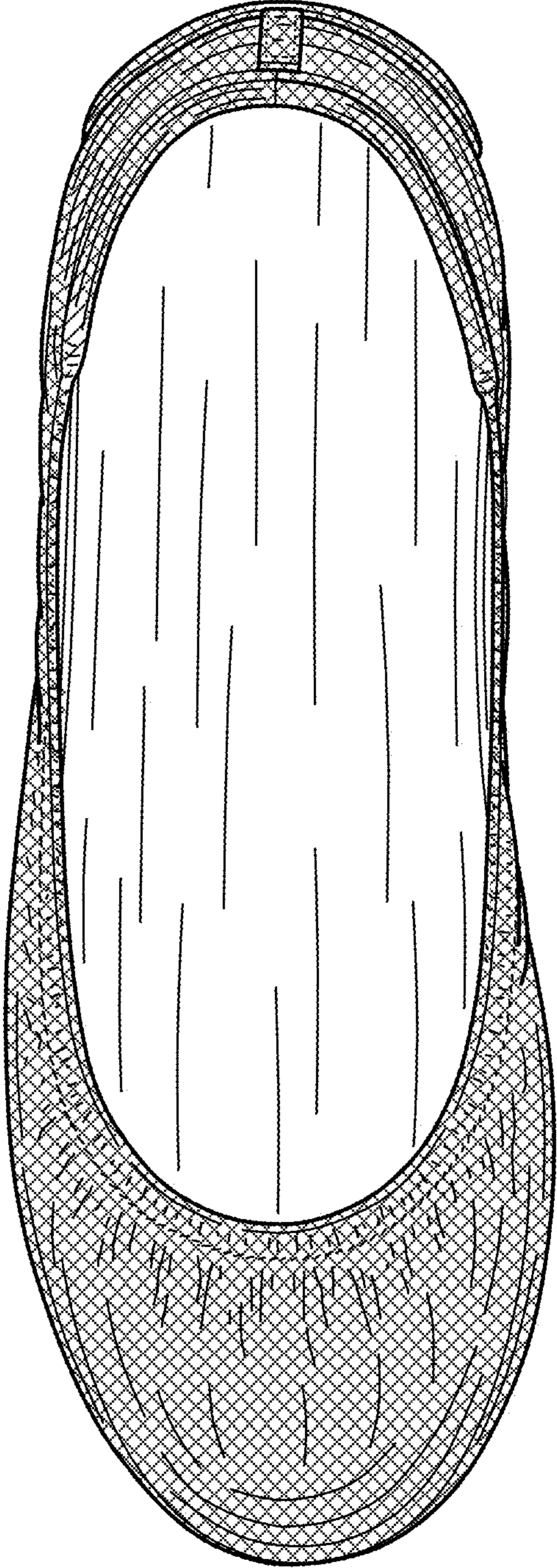

FIG. 4



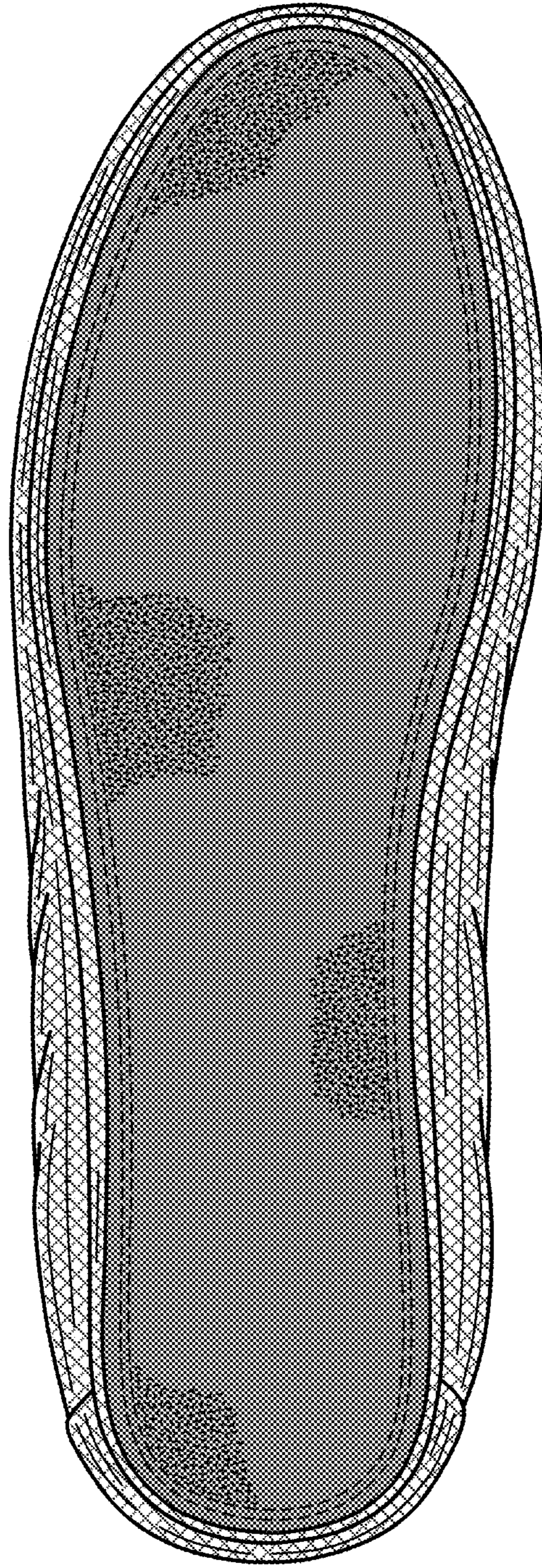

FIG. 5

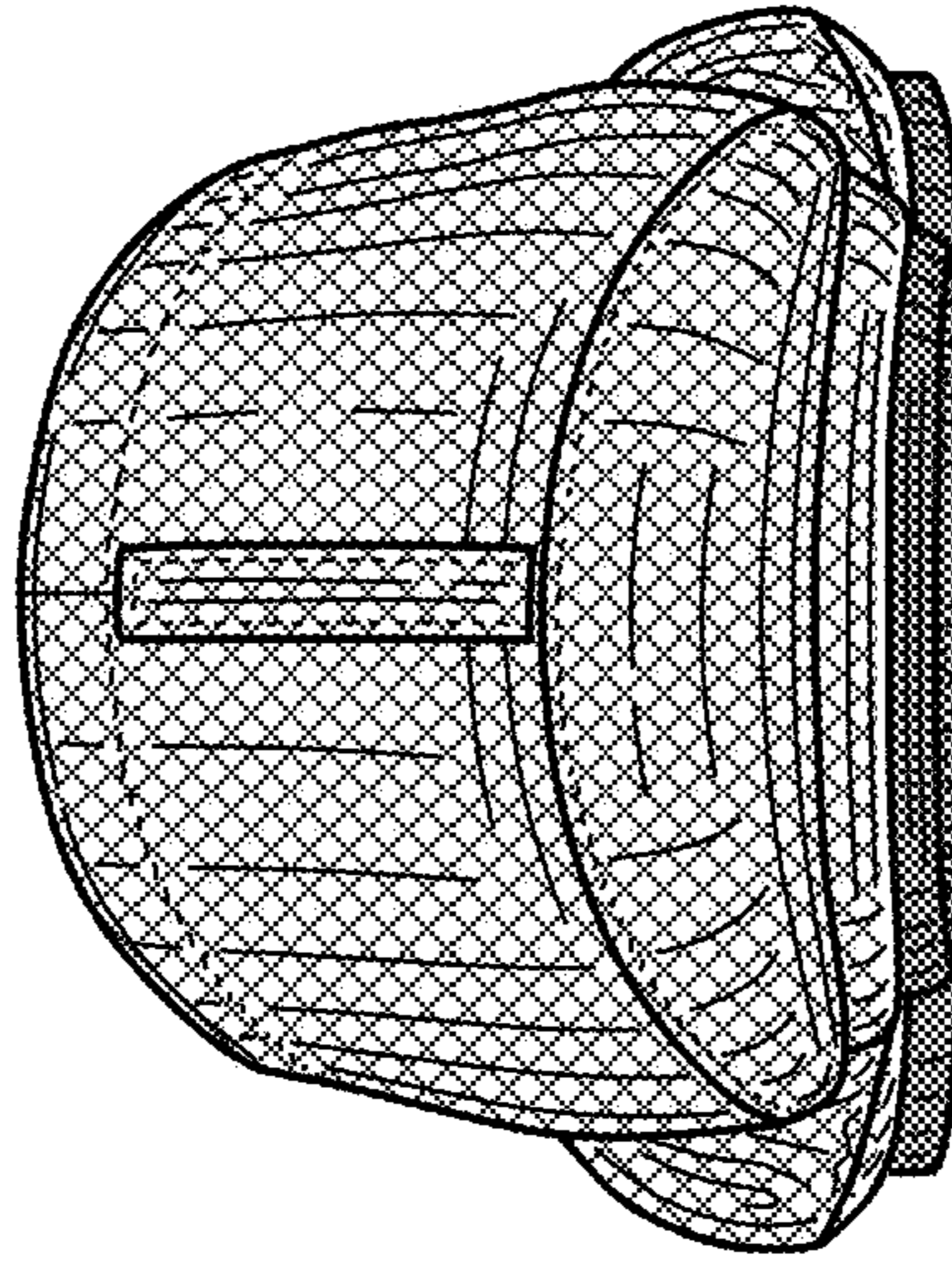

FIG. 7

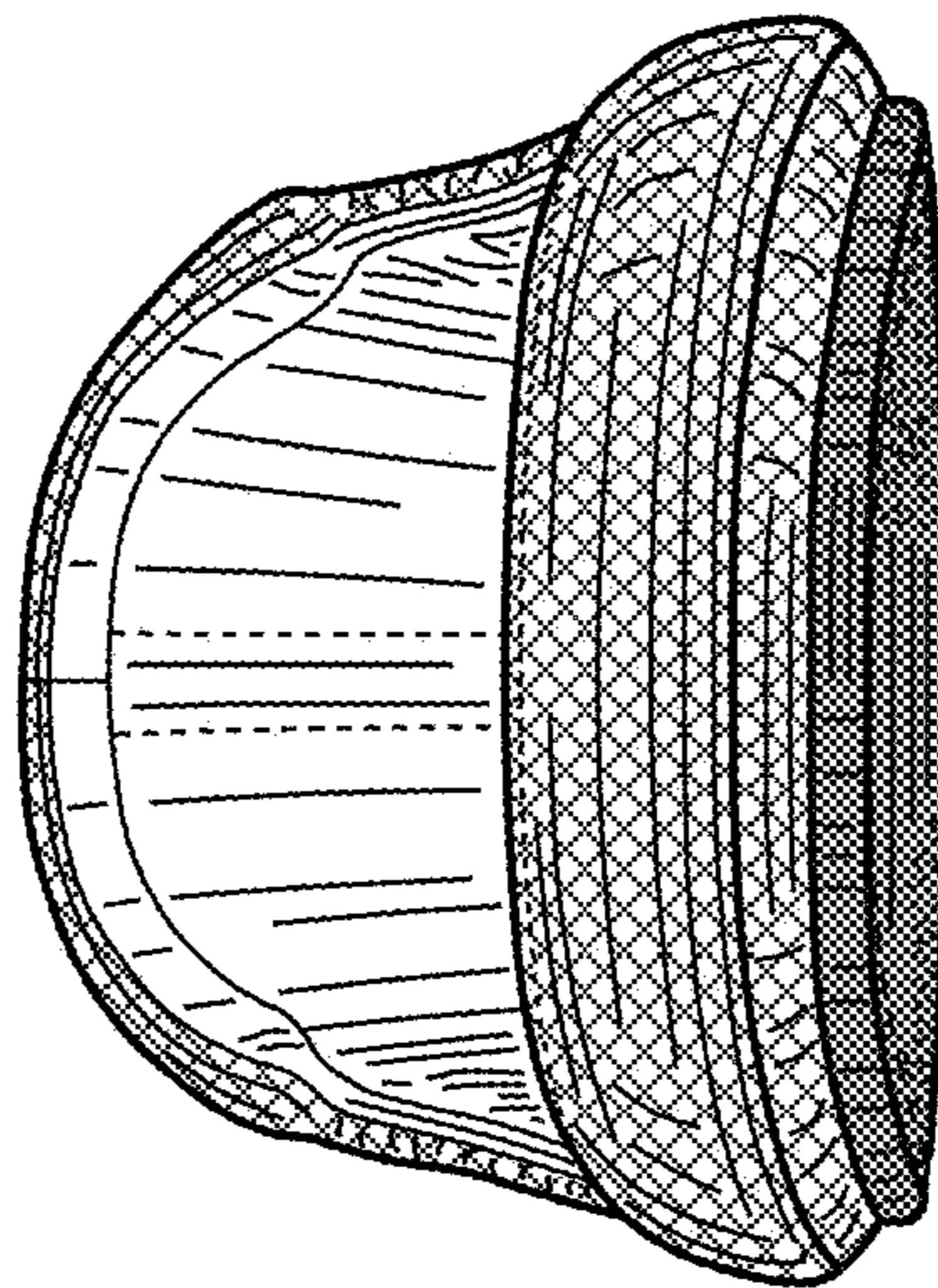

FIG. 6

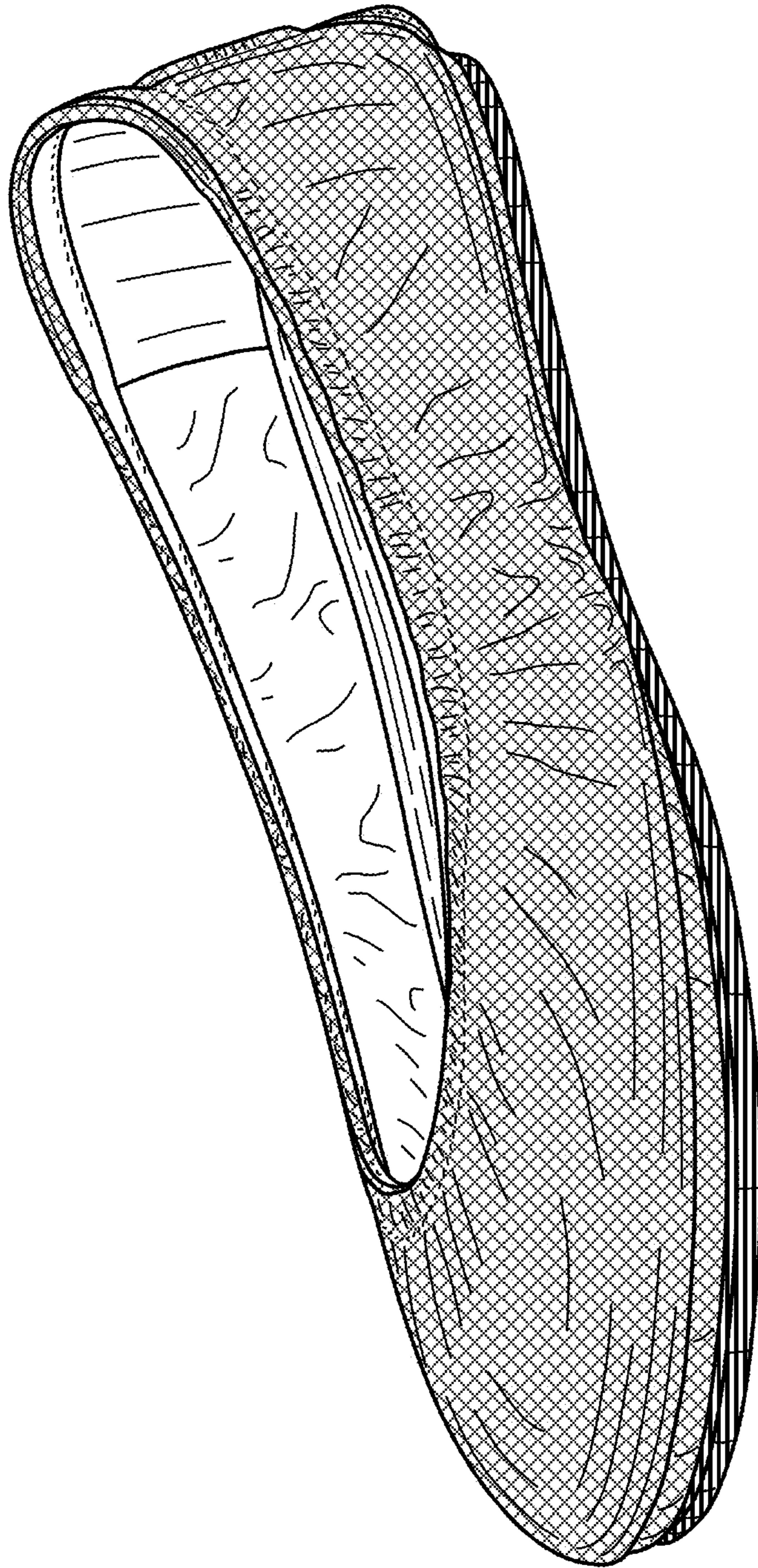

FIG. 8

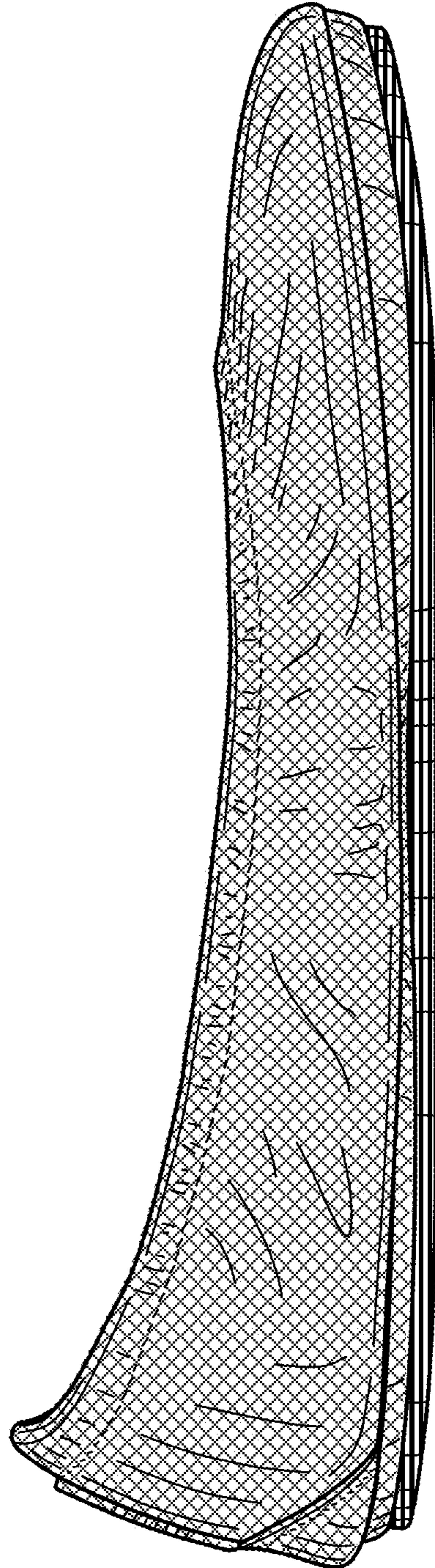

FIG. 9

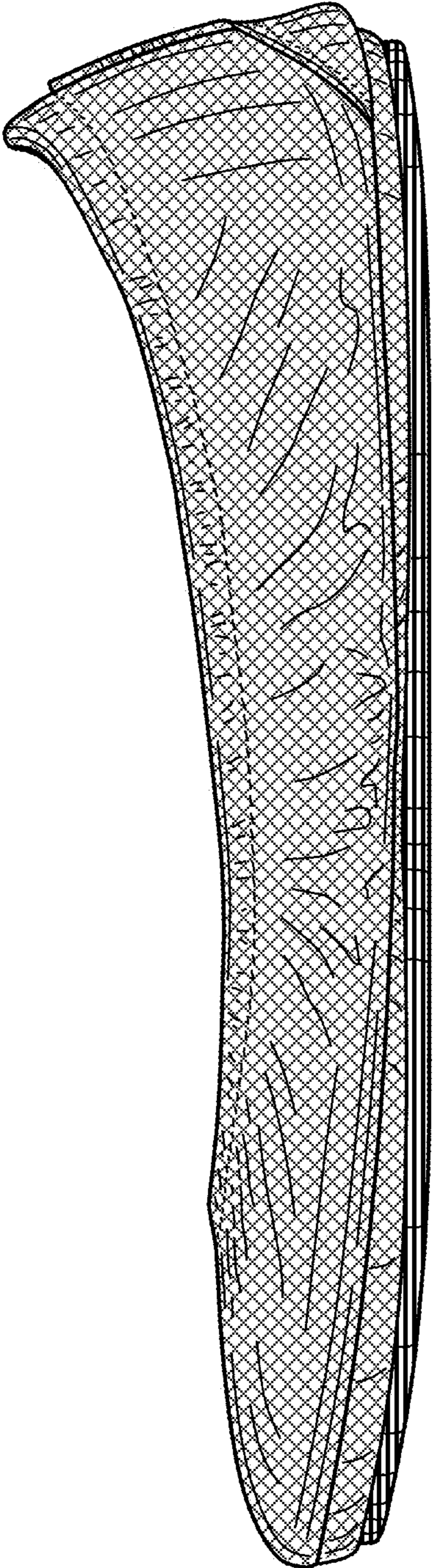

FIG. 10

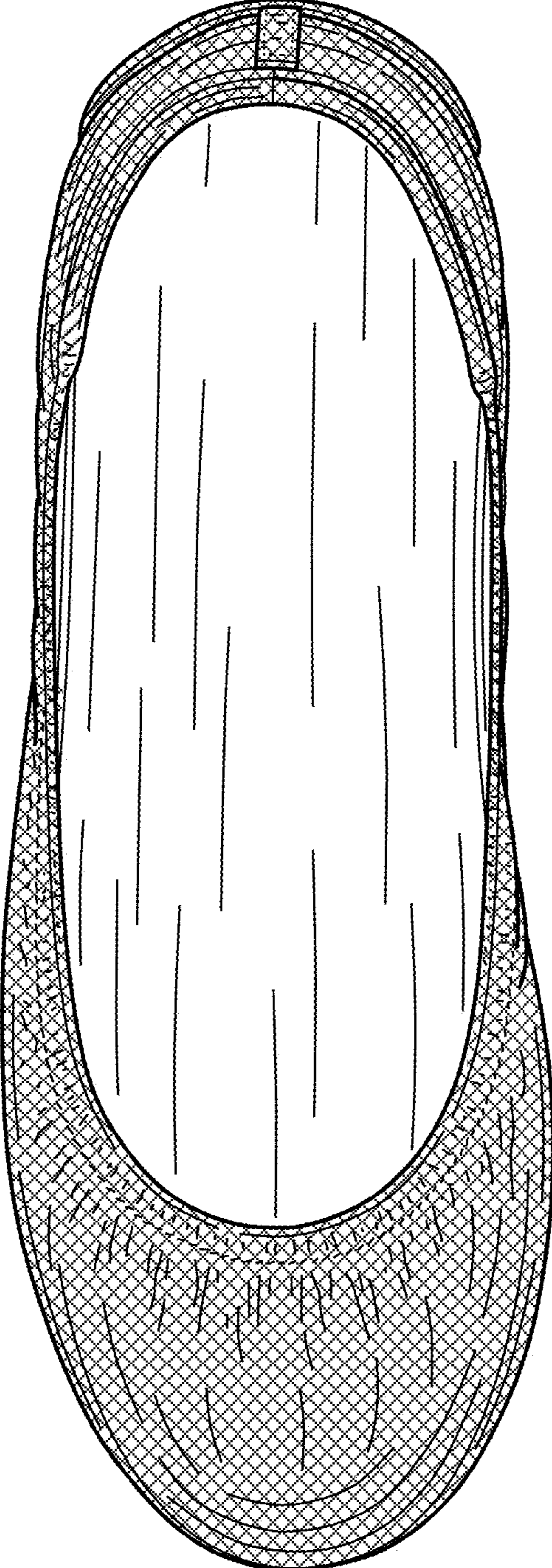

FIG. 11

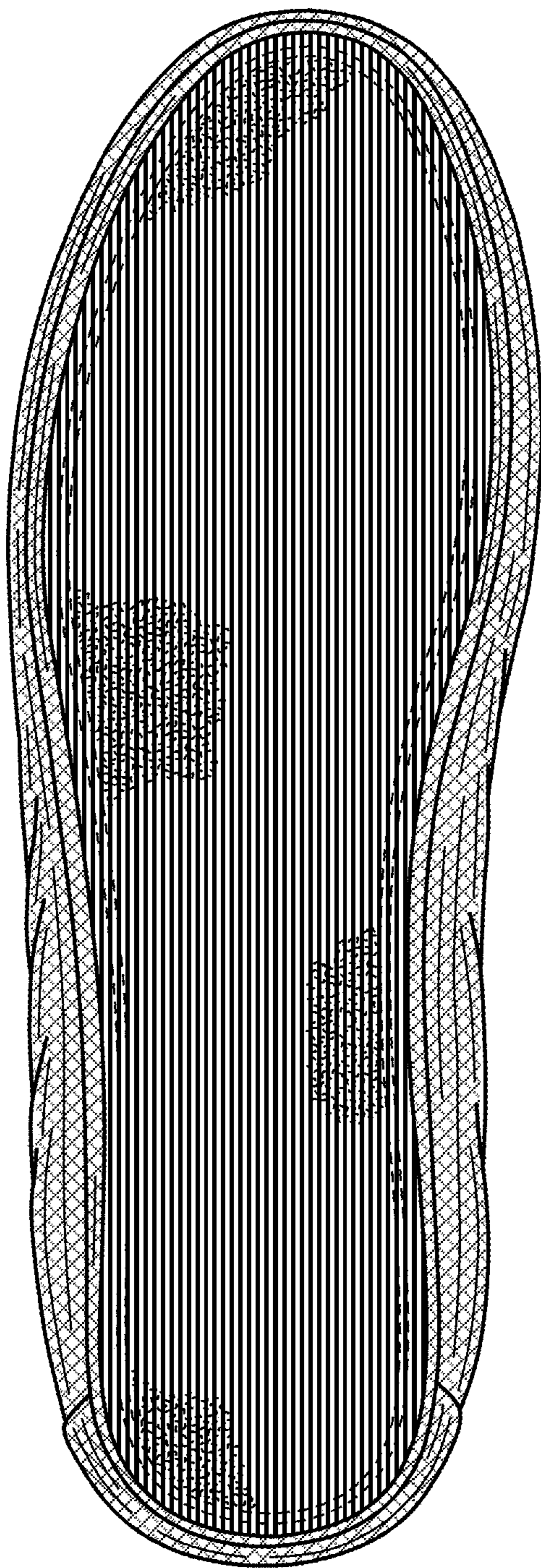

FIG. 12

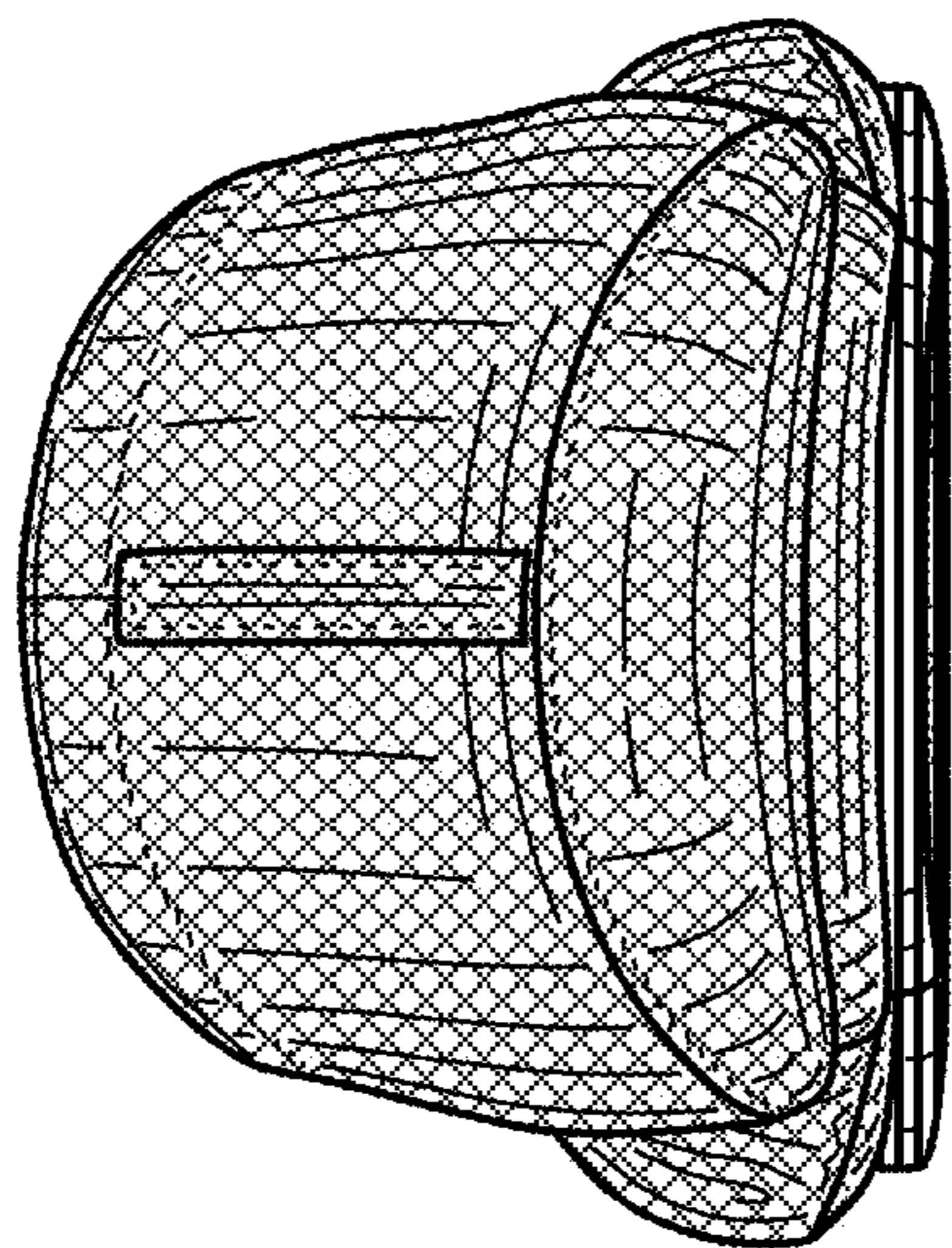

FIG. 14

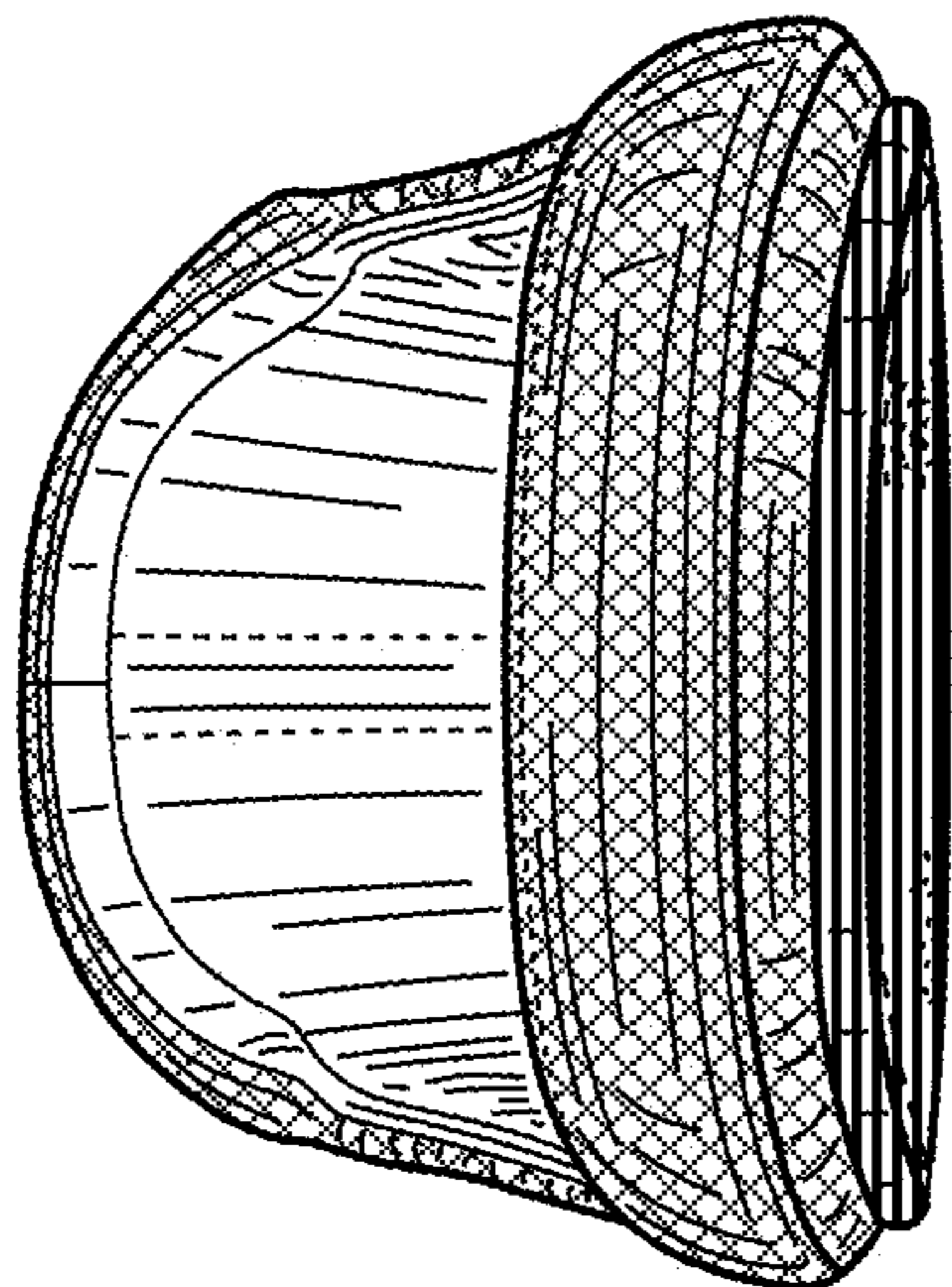

FIG. 13



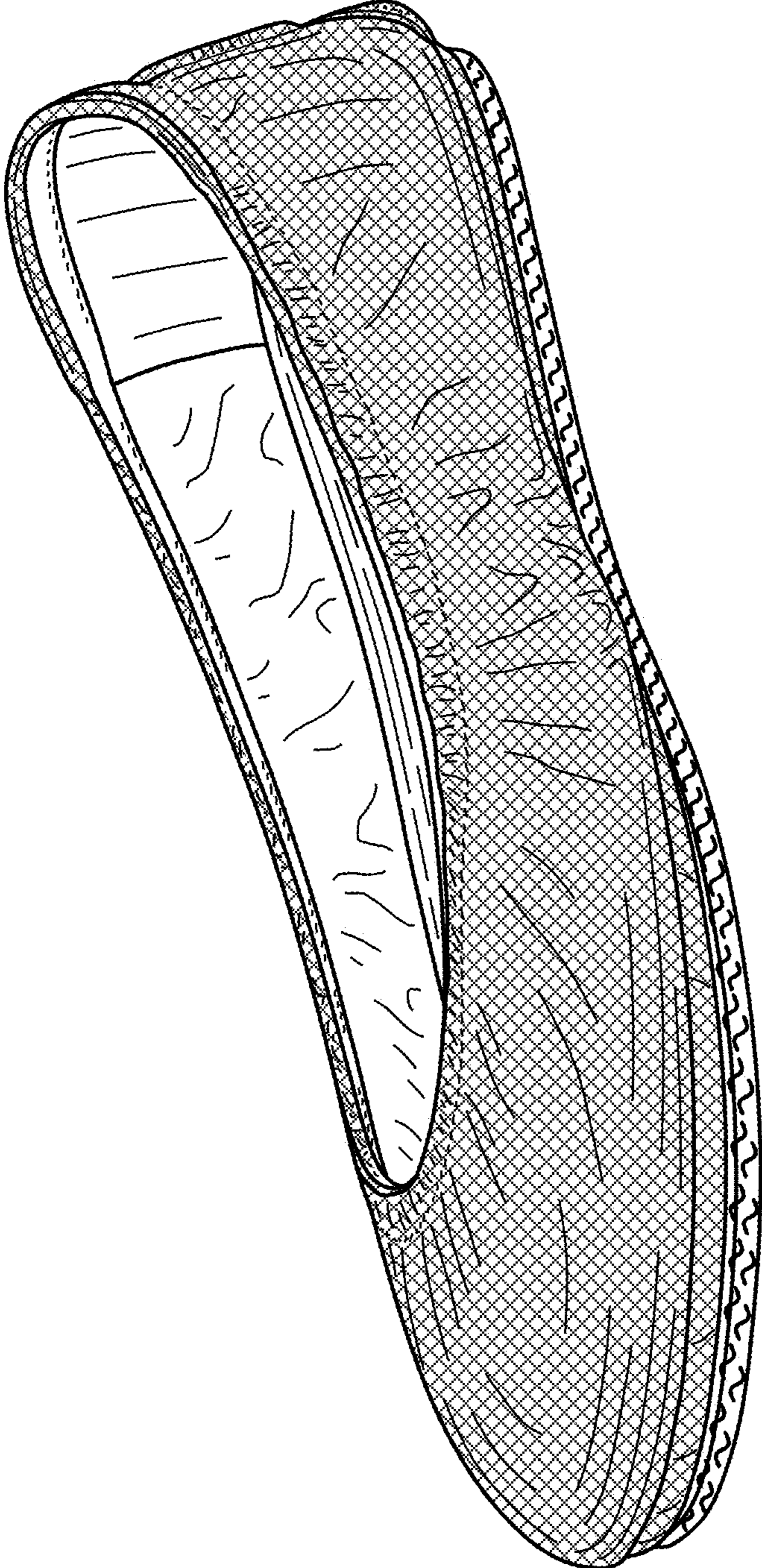

FIG. 15

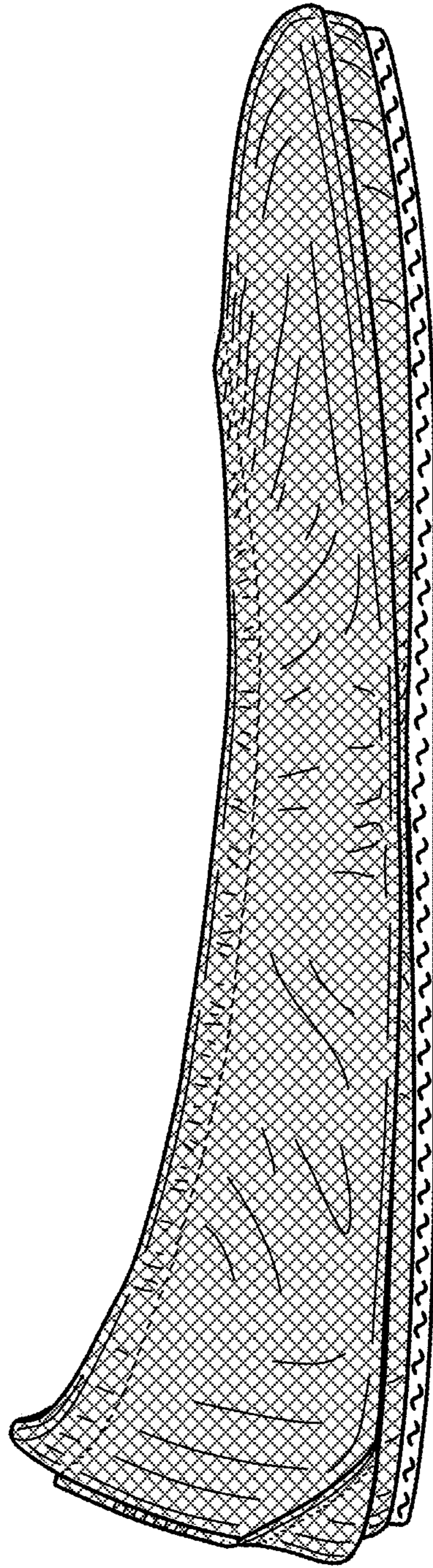

FIG. 16

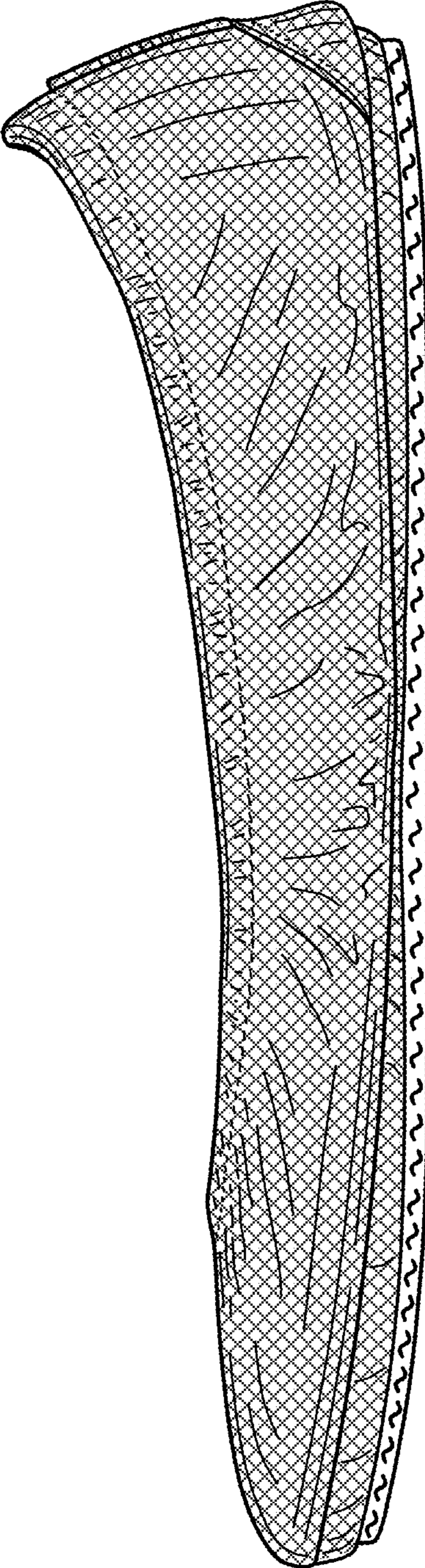

FIG. 17

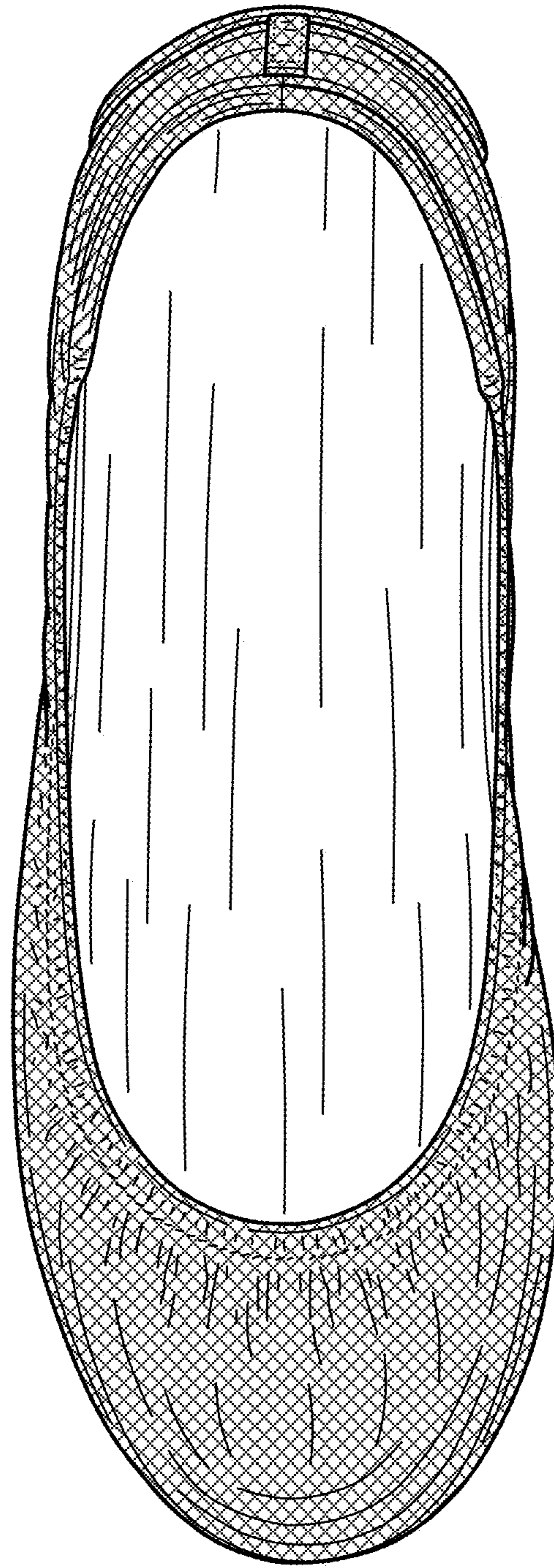

FIG. 18

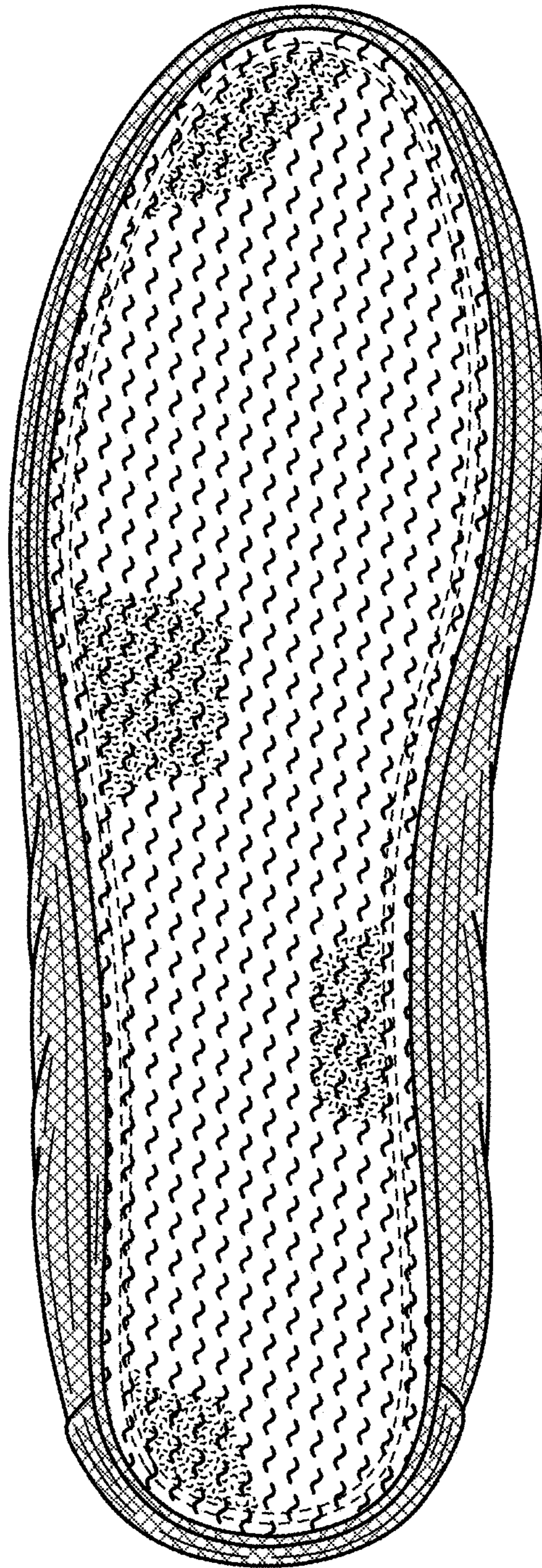

FIG. 19

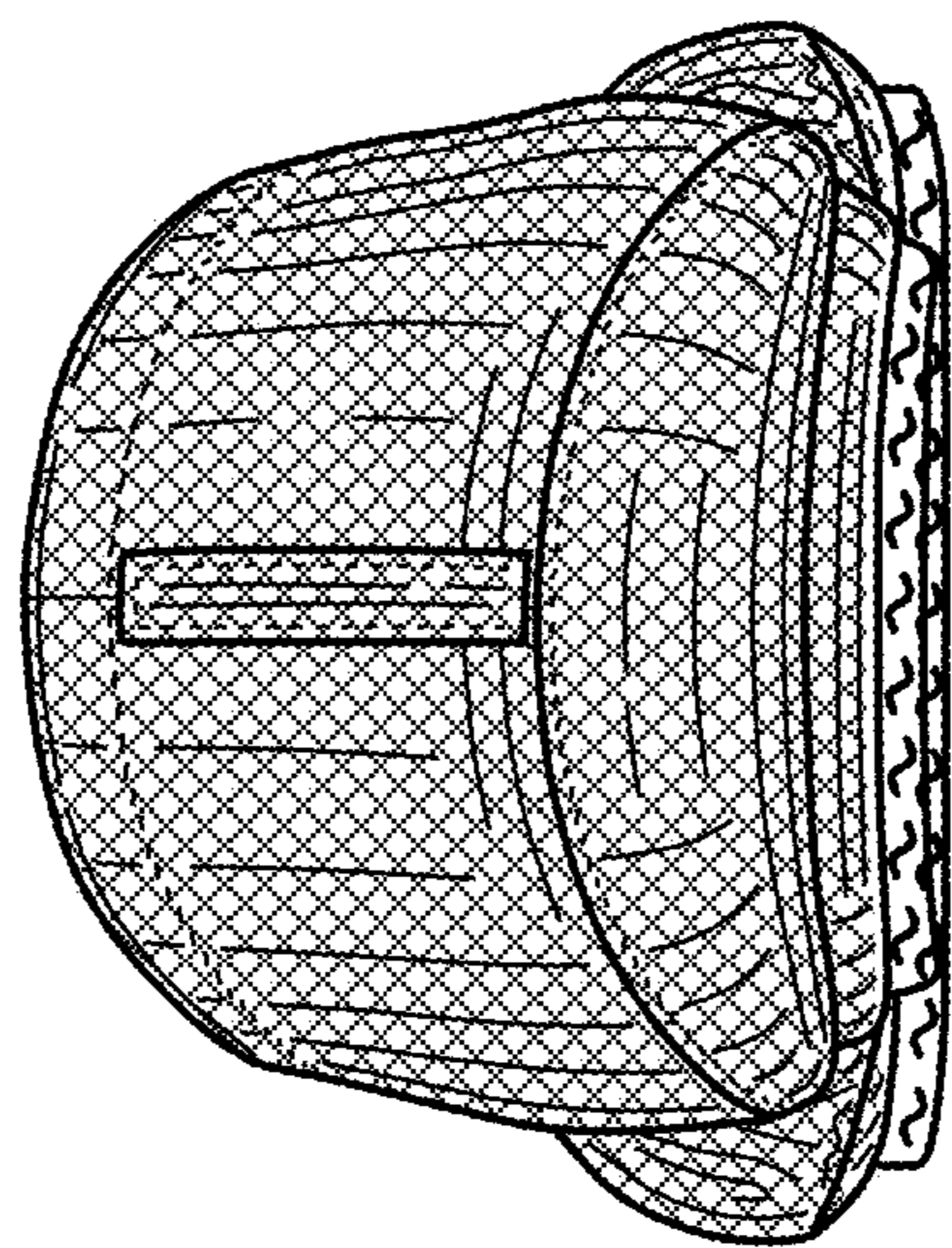

FIG. 21

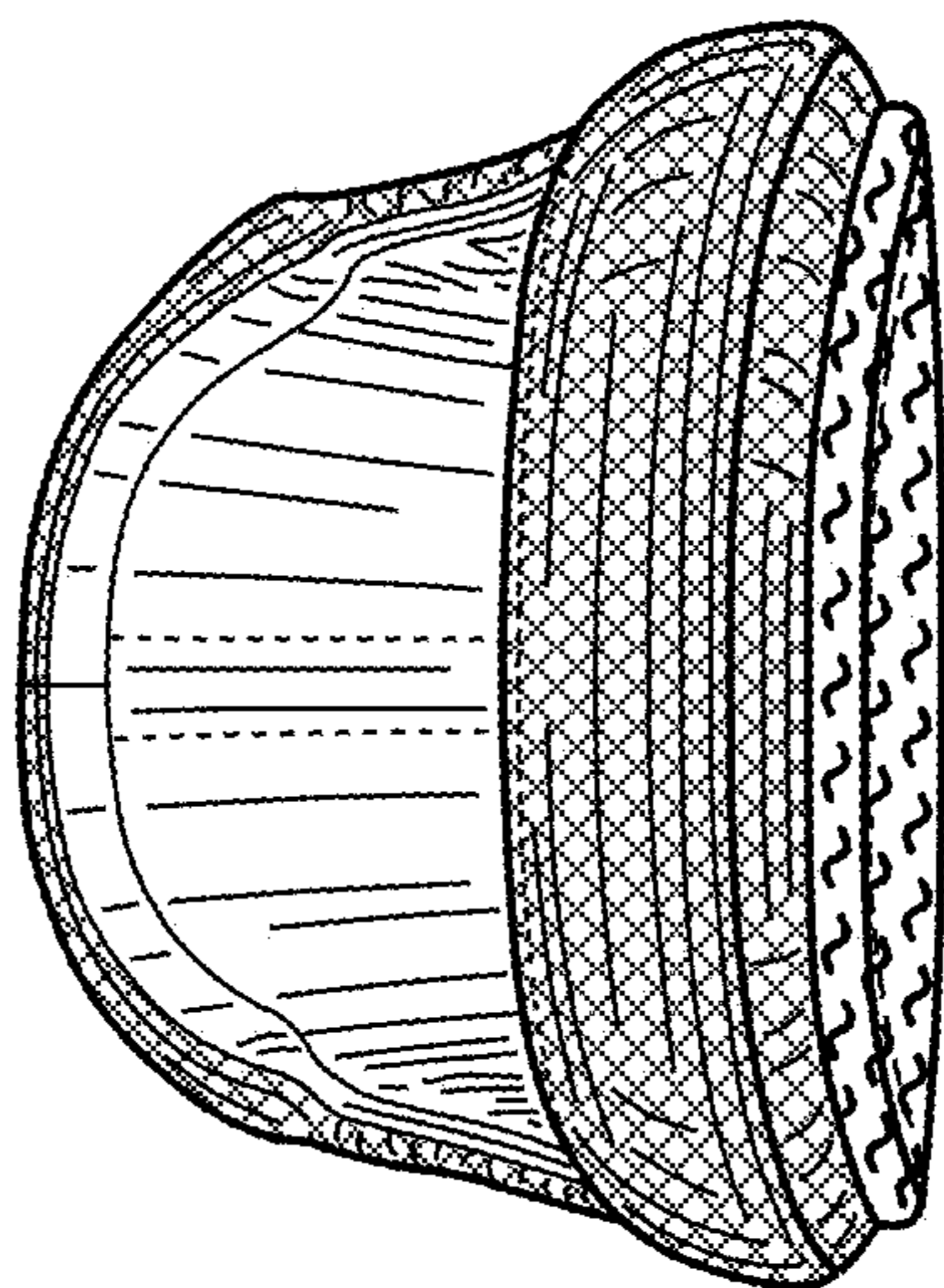

FIG. 20