



US00D755378S

(12) **United States Design Patent**
Dejima

(10) **Patent No.:** **US D755,378 S**
(45) **Date of Patent:** **** May 3, 2016**

(54) **ENDOSCOPE**
(71) Applicant: **FUJIFILM Corporation**, Tokyo (JP)
(72) Inventor: **Takumi Dejima**, Ashigarakami-gun (JP)
(73) Assignee: **FUJIFILM Corporation**, Tokyo (JP)
(**) Term: **14 Years**
(21) Appl. No.: **29/503,870**
(22) Filed: **Sep. 30, 2014**
(51) **LOC (10) Cl.** **24-02**
(52) **U.S. Cl.**
USPC **D24/138**
(58) **Field of Classification Search**
USPC D24/138, 137, 133, 135, 140; 600/131,
600/132, 145-147
CPC A61B 1/267; A61B 1/2673; A61B 1/2676;
A61B 1/00; A61B 1/00052; A61B 1/00066;
A61B 5/0077; A61B 19/5223; A61B 19/5225;
A61B 1/04; A61B 8/5215; G02B 23/24
See application file for complete search history.

(56) **References Cited**

U.S. PATENT DOCUMENTS

3,132,646 A * 5/1964 Hett A61B 1/2676
600/140
3,175,554 A * 3/1965 Stewart A61B 10/0266
600/567
3,368,552 A * 2/1968 Bottcher A61B 1/00098
D24/138
3,805,770 A * 4/1974 Okada A61B 1/31
D24/138
D279,604 S * 7/1985 Nishigaki D24/138
4,736,733 A * 4/1988 Adair A61B 1/00195
D24/137
D342,136 S * 12/1993 Lafferty D24/112
D351,022 S * 9/1994 Saito D24/146
D420,131 S * 2/2000 Renner D24/138
D428,487 S * 7/2000 Renner D24/138
D440,659 S * 4/2001 Ogino D24/138
D448,085 S * 9/2001 Conway D24/216
6,443,945 B1 * 9/2002 Marchitto A61B 5/411
128/897

D489,132 S * 4/2004 Inami D24/150
D496,728 S * 9/2004 Holsinger D24/108
D533,662 S * 12/2006 Nakajima D24/138
D590,945 S * 4/2009 Berberich D24/133
D591,438 S * 4/2009 Hama D24/133
D593,202 S * 5/2009 Petersen D24/133
D634,842 S * 3/2011 Fuerst D24/138
D656,613 S * 3/2012 Garcia D24/145
D667,114 S * 9/2012 Campo D24/138
D667,546 S * 9/2012 Becker D24/138
D694,406 S * 11/2013 Hahn D24/147
D696,399 S * 12/2013 Kleiner D24/133
D700,322 S * 2/2014 Kleiner D24/133
D727,499 S * 4/2015 Schad D24/146
D728,098 S * 4/2015 Schad D24/146
D729,384 S * 5/2015 Renner D24/138
2003/0139752 A1 * 7/2003 Pasricha A61B 17/0482
606/139
2007/0106118 A1 5/2007 Moriyama
2008/0214890 A1 * 9/2008 Motai A61B 1/00135
600/107
2010/0198005 A1 * 8/2010 Fox A61B 17/0218
600/104
2010/0198149 A1 * 8/2010 Fox A61B 17/3478
604/99.01
2010/0249700 A1 * 9/2010 Spivey A61B 17/00234
604/96.01
2013/0023840 A1 * 1/2013 Loske A61M 1/0084
604/319
2013/0066304 A1 * 3/2013 Belson A61B 17/00234
606/1
2014/0024896 A1 * 1/2014 West A61B 1/00135
600/114

FOREIGN PATENT DOCUMENTS

CN 302721997 * 1/2014
FR 814169-001 * 6/1981
FR 871324-003 * 2/1988
JP 6-319687 A 11/1994
JP 9-489 A 1/1997
JP 2004-41580 A 2/2004
JP 2006-14960 A 1/2006
JP D1347724 * 1/2009
JP 2014-33933 A 2/2014
JP D1532963 * 9/2015
JP D1533138 * 9/2015

OTHER PUBLICATIONS

Alibaba. <URL: http://www.alibaba.com/productdetail/AluminiumTelescopepoleHandlePipetube_692675137.html>. Visited Nov. 20, 2015. Expandable aluminum telescope pole/tube.*

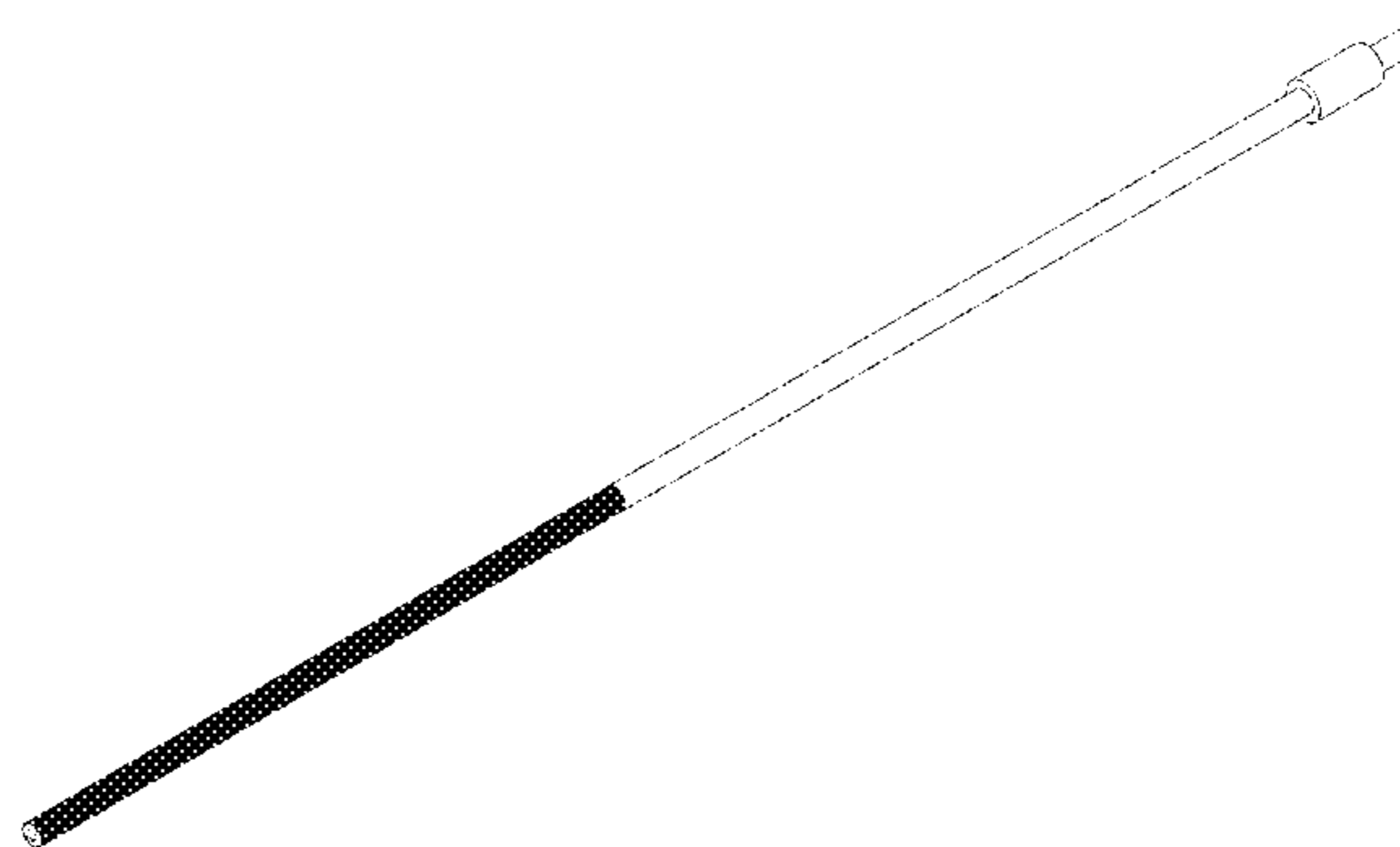
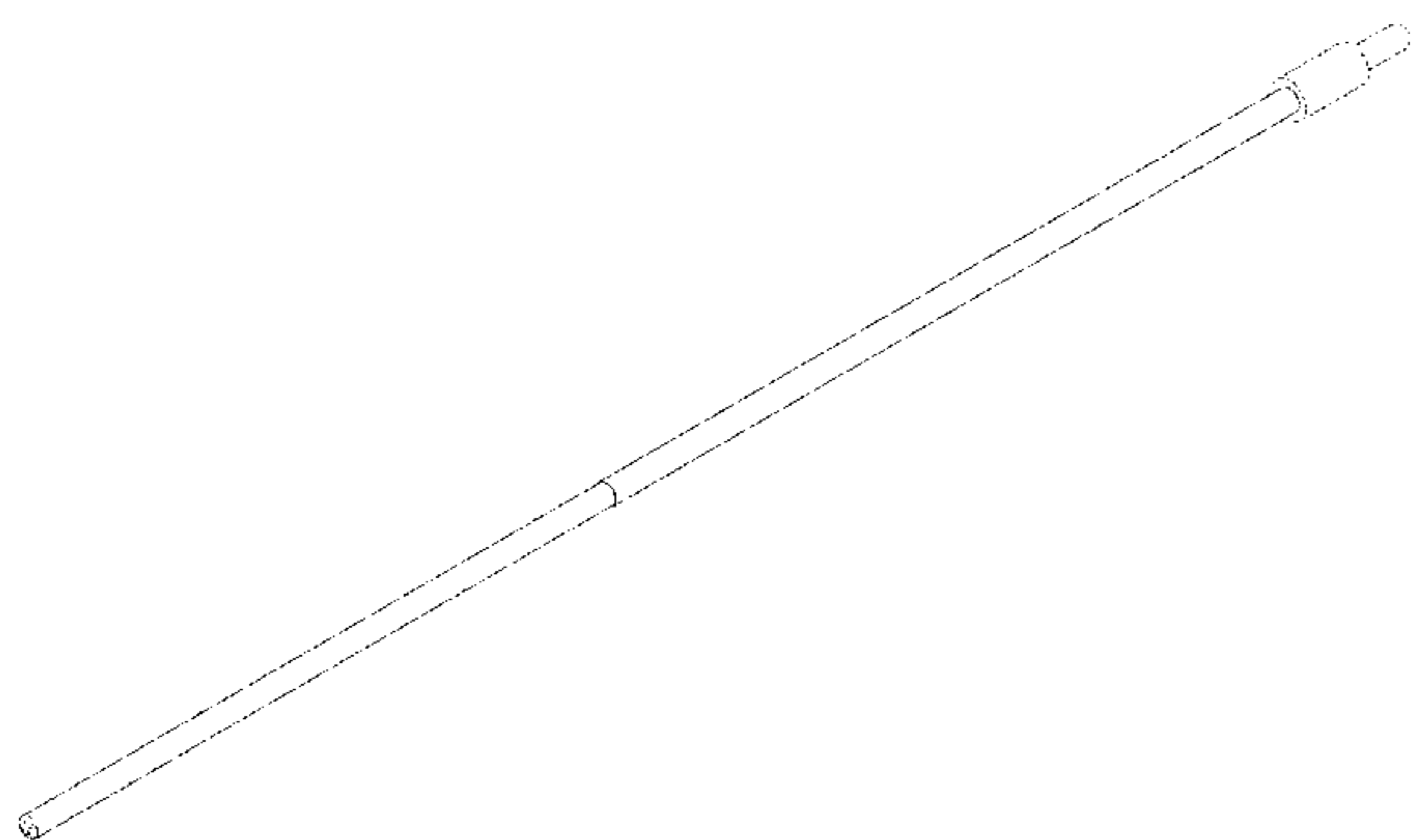

Japanese Office Action for Japanese Application No. 2015-000389, dated Jul. 3, 2015, with a partial English translation.
Japanese Office Action for Japanese Application No. 2015-000390, dated Jul. 3, 2015, with a partial English translation.

* cited by examiner

Primary Examiner — Bridget L Eland
Assistant Examiner — Lauren McVey
(74) *Attorney, Agent, or Firm* — Birch, Stewart, Kolasch & Birch, LLP

(57) **CLAIM**
The ornamental design for an endoscope, as shown and described.

DESCRIPTION

FIG. 1 is a perspective view of an endoscope showing a first embodiment of my new design;
FIG. 2 is a front elevational view thereof, the rear elevational view being a mirror image;
FIG. 3 is a top plan view thereof, the bottom plan view being a mirror image;
FIG. 4 is a left side view thereof;
FIG. 5 is a right side view thereof;
FIG. 6 is an enlarged left side view;
FIG. 7 is an enlarged front elevational view of 7-7 section of FIG. 2;
FIG. 8 is a perspective view of an endoscope showing a second embodiment of my new design;
FIG. 9 is a front elevational view thereof, the rear elevational view being a mirror image;
FIG. 10 is a top plan view thereof, the bottom plan view being a mirror image;
FIG. 11 is a left side view thereof;
FIG. 12 is a right side view thereof;
FIG. 13 is an enlarged left side view;
FIG. 14 is an enlarged front elevational view of 14-14 section of FIG. 9;
FIG. 15 is a perspective view of an endoscope showing a third embodiment of my new design;
FIG. 16 is a front elevational view thereof, the rear elevational view being a mirror image;
FIG. 17 is a top plan view thereof, the bottom plan view being a mirror image;
FIG. 18 is a left side view thereof;
FIG. 19 is a right side view thereof;
FIG. 20 is an enlarged left side view;
FIG. 21 is an enlarged front elevational view of 21-21 section of FIG. 16;
FIG. 22 is a perspective view of an endoscope showing a fourth embodiment of my new design;
FIG. 23 is a front elevational view thereof, the rear elevational view being a mirror image;
FIG. 24 is a top plan view thereof, the bottom plan view being a mirror image;
FIG. 25 is a left side view thereof;
FIG. 26 is a right side view thereof;
FIG. 27 is an enlarged left side view;
FIG. 28 is an enlarged front elevational view of 28-28 section of FIG. 23;
FIG. 29 is a perspective view of an endoscope showing a fifth embodiment of my new design;
FIG. 30 is a front elevational view thereof, the rear elevational view being a mirror image;

FIG. 31 is a top plan view thereof, the bottom plan view being a mirror image;
FIG. 32 is a left side view thereof;
FIG. 33 is a right side view thereof;
FIG. 34 is an enlarged left side view;
FIG. 35 is an enlarged front elevational view of 35-35 section of FIG. 30;
FIG. 36 is a perspective view of an endoscope showing a sixth embodiment of my new design;
FIG. 37 is a front elevational view thereof, the rear elevational view being a mirror image;
FIG. 38 is a top plan view thereof, the bottom plan view being a mirror image;
FIG. 39 is a left side view thereof;
FIG. 40 is a right side view thereof;
FIG. 41 is an enlarged left side view;
FIG. 42 is an enlarged front elevational view of 42-42 section of FIG. 37;
FIG. 43 is a perspective view of an endoscope showing a seventh embodiment of my new design;
FIG. 44 is a front elevational view thereof, the rear elevational view being a mirror image;
FIG. 45 is a top plan view thereof, the bottom plan view being a mirror image;
FIG. 46 is a left side view thereof;
FIG. 47 is a right side view thereof;
FIG. 48 is an enlarged left side view;
FIG. 49 is an enlarged front elevational view of 49-49 section of FIG. 44;
FIG. 50 is a perspective view of an endoscope showing an eighth embodiment of my new design;
FIG. 51 is a front elevational view thereof, the rear elevational view being a mirror image;
FIG. 52 is a top plan view thereof, the bottom plan view being a mirror image;
FIG. 53 is a left side view thereof;
FIG. 54 is a right side view thereof;
FIG. 55 is an enlarged left side view;
FIG. 56 is an enlarged front elevational view of 56-56 section of FIG. 51;
FIG. 57 is a perspective view of an endoscope showing a ninth embodiment of my new design;
FIG. 58 is a front elevational view thereof, the rear elevational view being a mirror image;
FIG. 59 is a top plan view thereof, the bottom plan view being a mirror image;
FIG. 60 is a left side view thereof;
FIG. 61 is a right side view thereof;
FIG. 62 is an enlarged left side view;
FIG. 63 is an enlarged front elevational view of 63-63 section of FIG. 58;
FIG. 64 is a perspective view of an endoscope showing a tenth embodiment of my new design;
FIG. 65 is a front elevational view thereof, the rear elevational view being a mirror image;
FIG. 66 is a top plan view thereof, the bottom plan view being a mirror image;
FIG. 67 is a left side view thereof;
FIG. 68 is a right side view thereof;
FIG. 69 is an enlarged left side view;
FIG. 70 is an enlarged front elevational view of 70-70 section of FIG. 65;
FIG. 71 is a perspective view of an endoscope showing an eleventh embodiment of my new design;

FIG. 72 is a front elevational view thereof, the rear elevational view being a mirror image;
FIG. 73 is a top plan view thereof, the bottom plan view being a mirror image;
FIG. 74 is a left side view thereof;
FIG. 75 is a right side view thereof;
FIG. 76 is an enlarged left side view;
FIG. 77 is an enlarged front elevational view of 77-77 section of FIG. 72;
FIG. 78 is a perspective view of an endoscope showing a twelfth embodiment of my new design;
FIG. 79 is a front elevational view thereof, the rear elevational view being a mirror image;

FIG. 80 is a top plan view thereof, the bottom plan view being a mirror image;
FIG. 81 is a left side view thereof;
FIG. 82 is a right side view thereof;
FIG. 83 is an enlarged left side view; and,
FIG. 84 is an enlarged front elevational view of 84-84 section of FIG. 79.
The broken lines are directed to environment and form no part of the claimed design.

1 Claim, 72 Drawing Sheets

FIG. 1

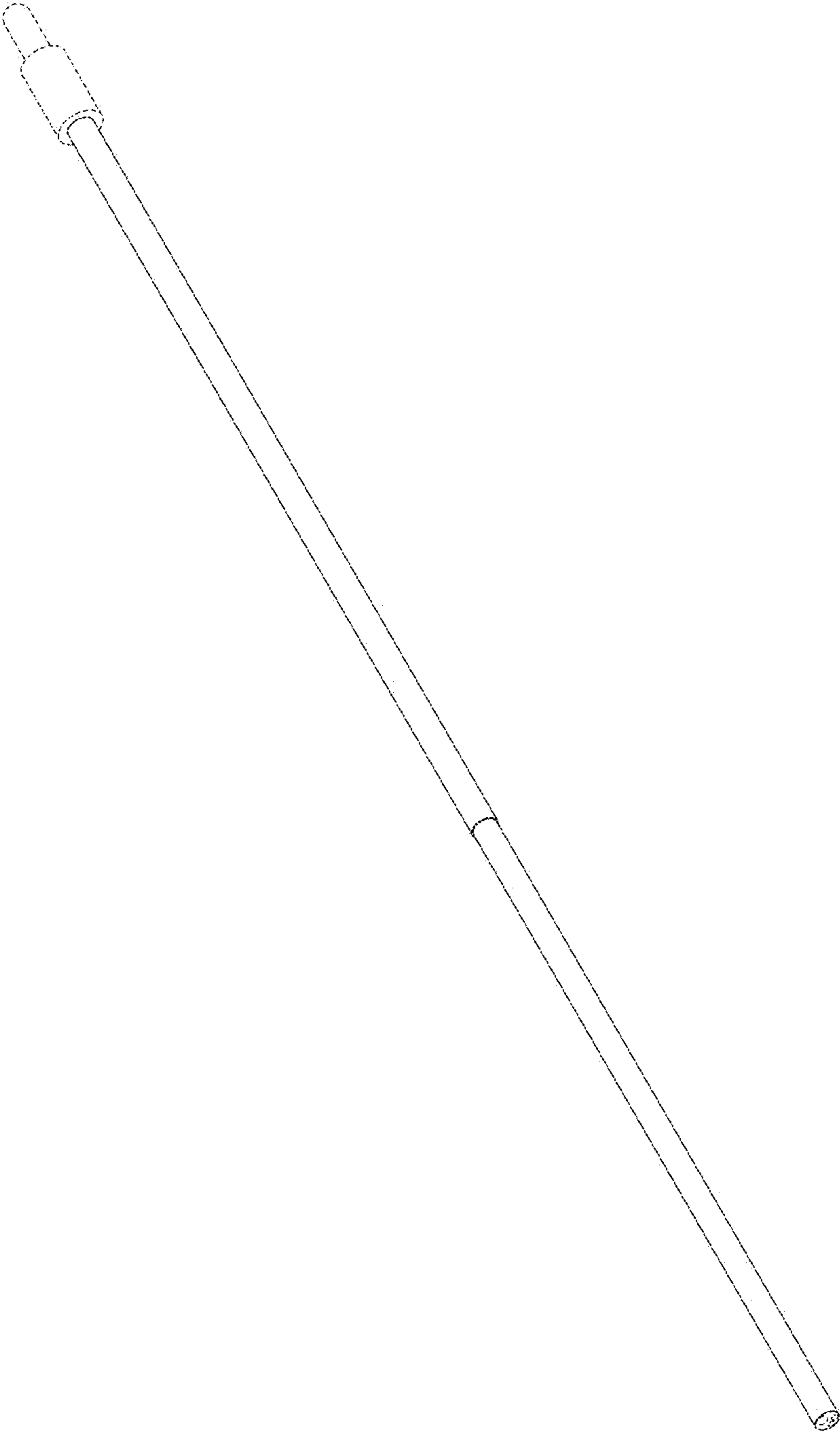

FIG. 2

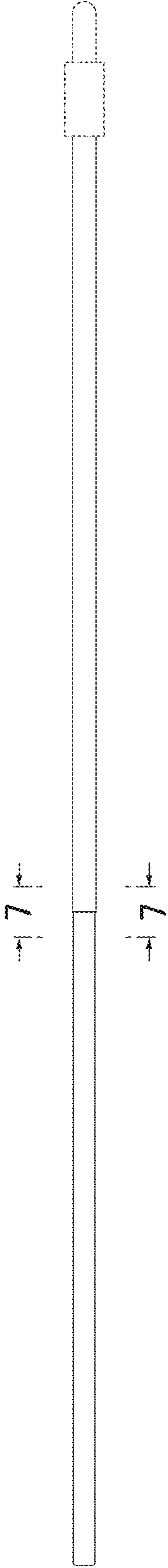

FIG. 3

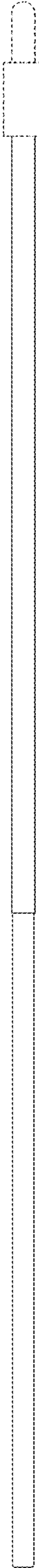

FIG. 4



FIG. 5



FIG. 6

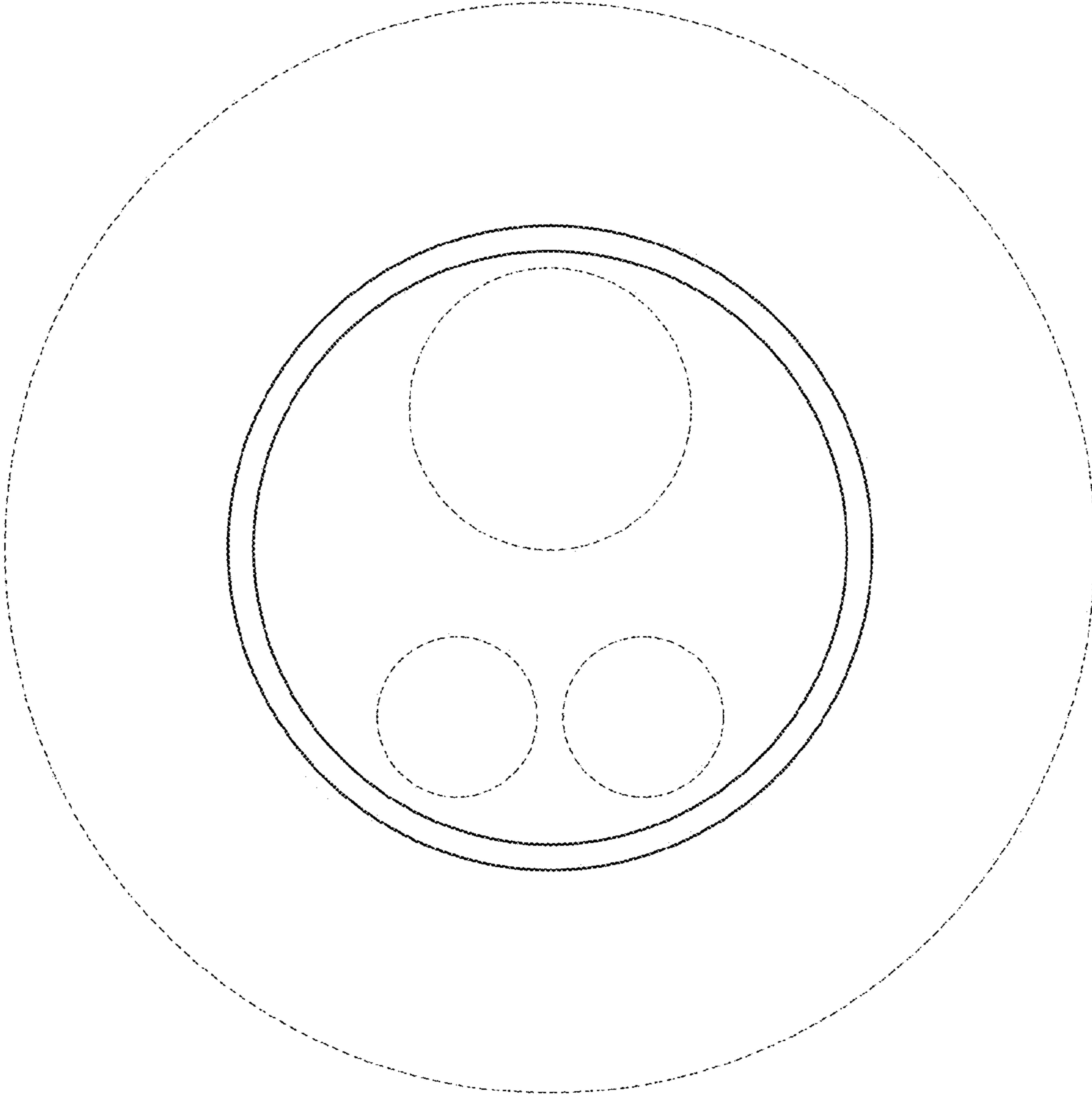

FIG. 7

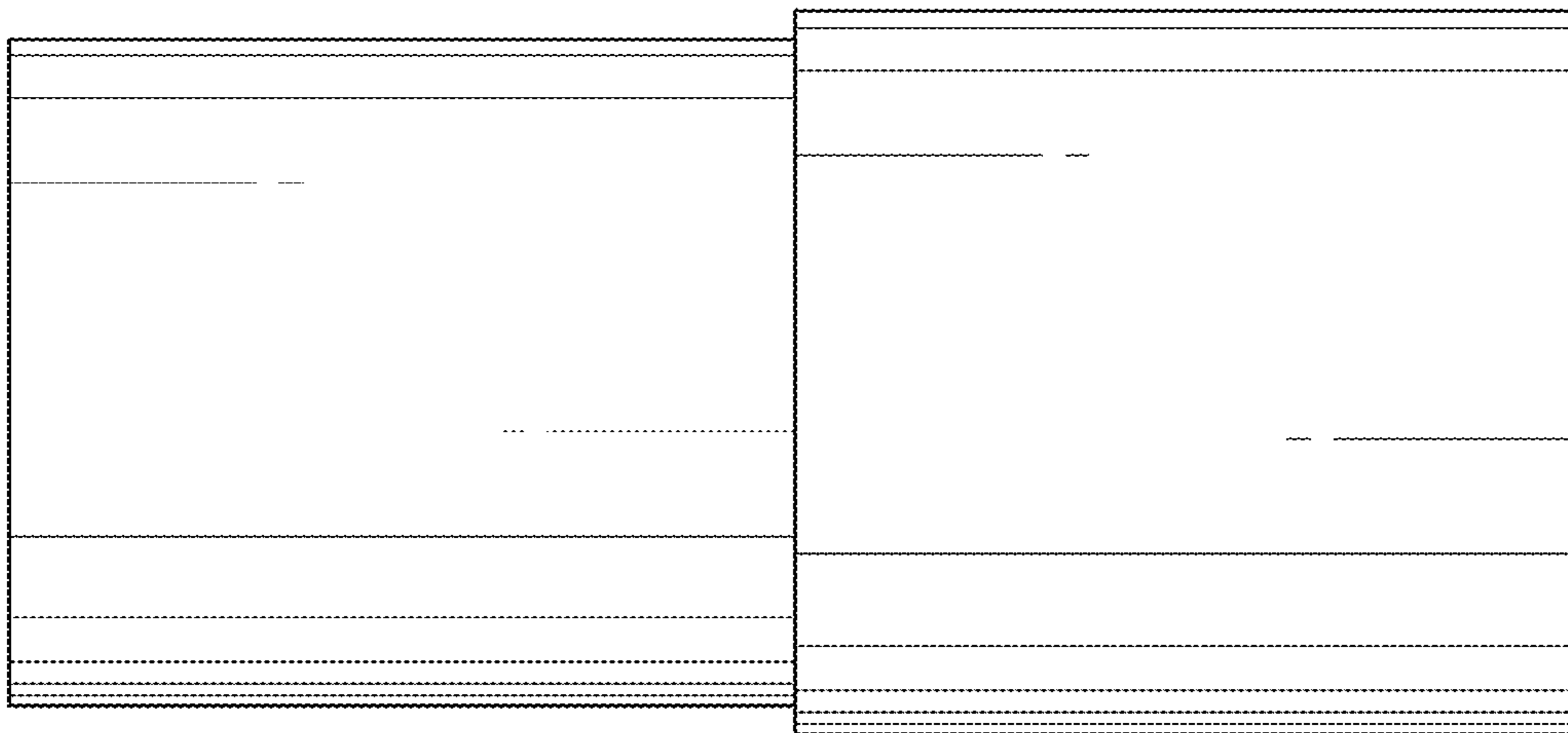

FIG. 8



FIG. 9

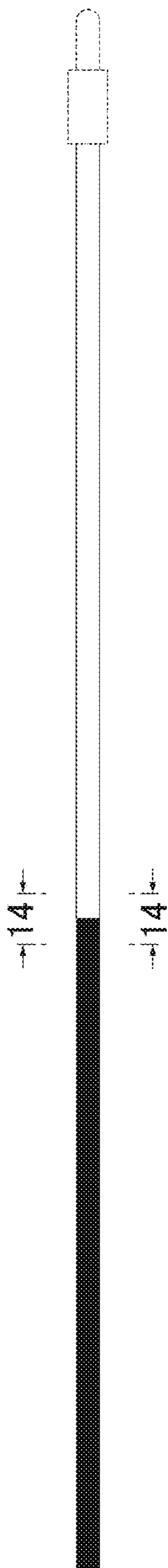

FIG. 10

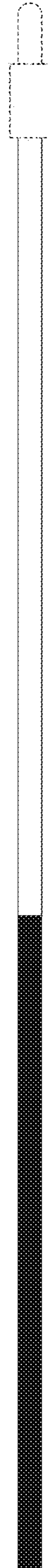

FIG. 11



FIG. 12



FIG. 13

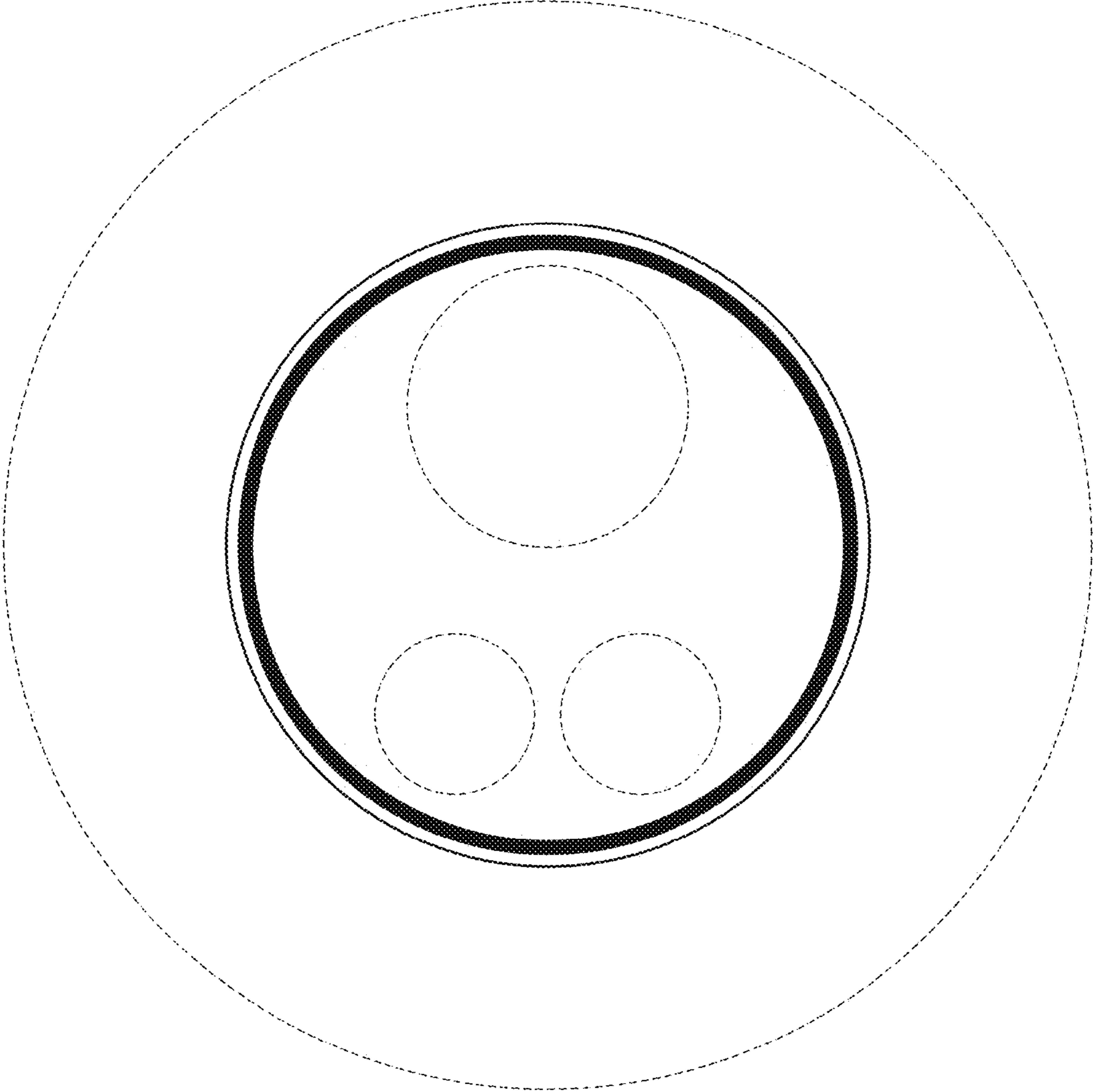

FIG. 14

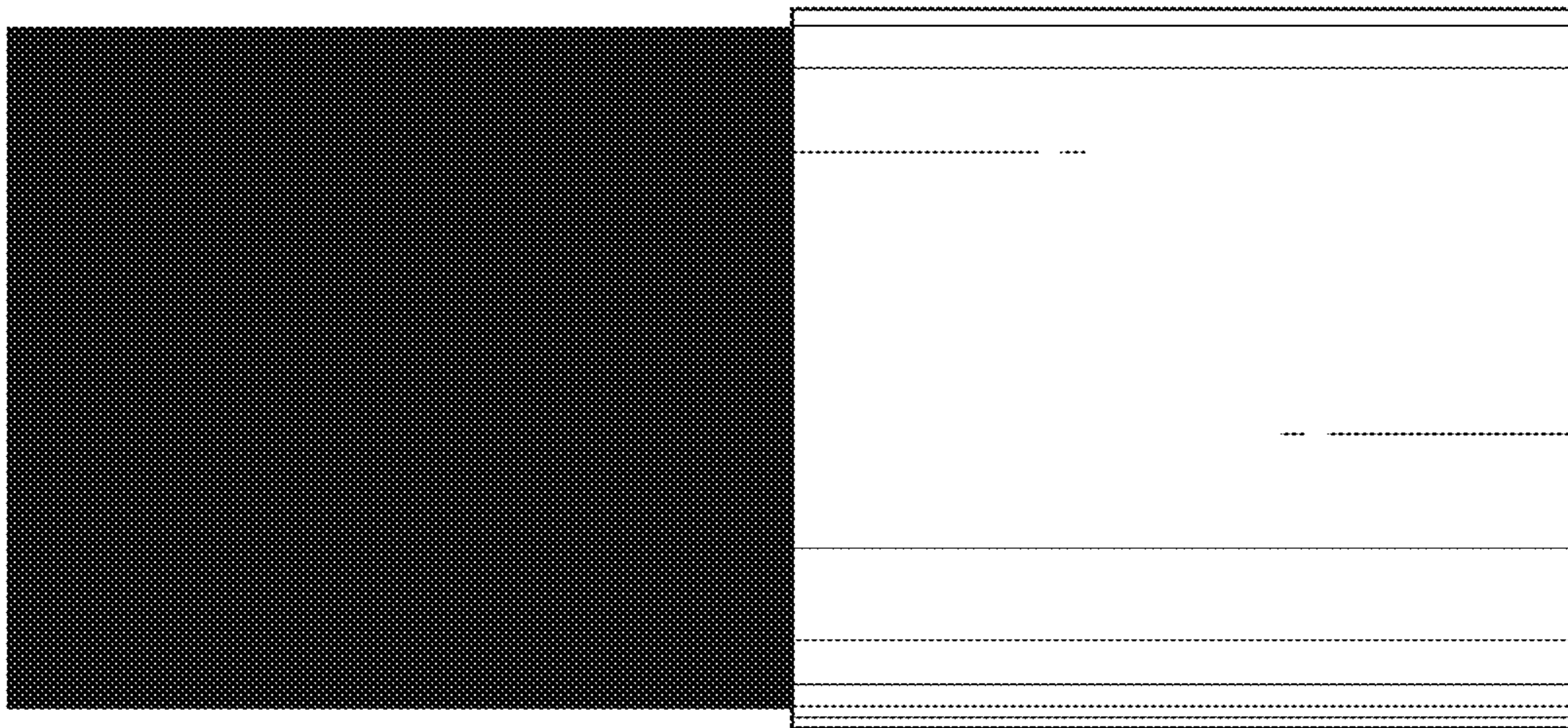

FIG. 15

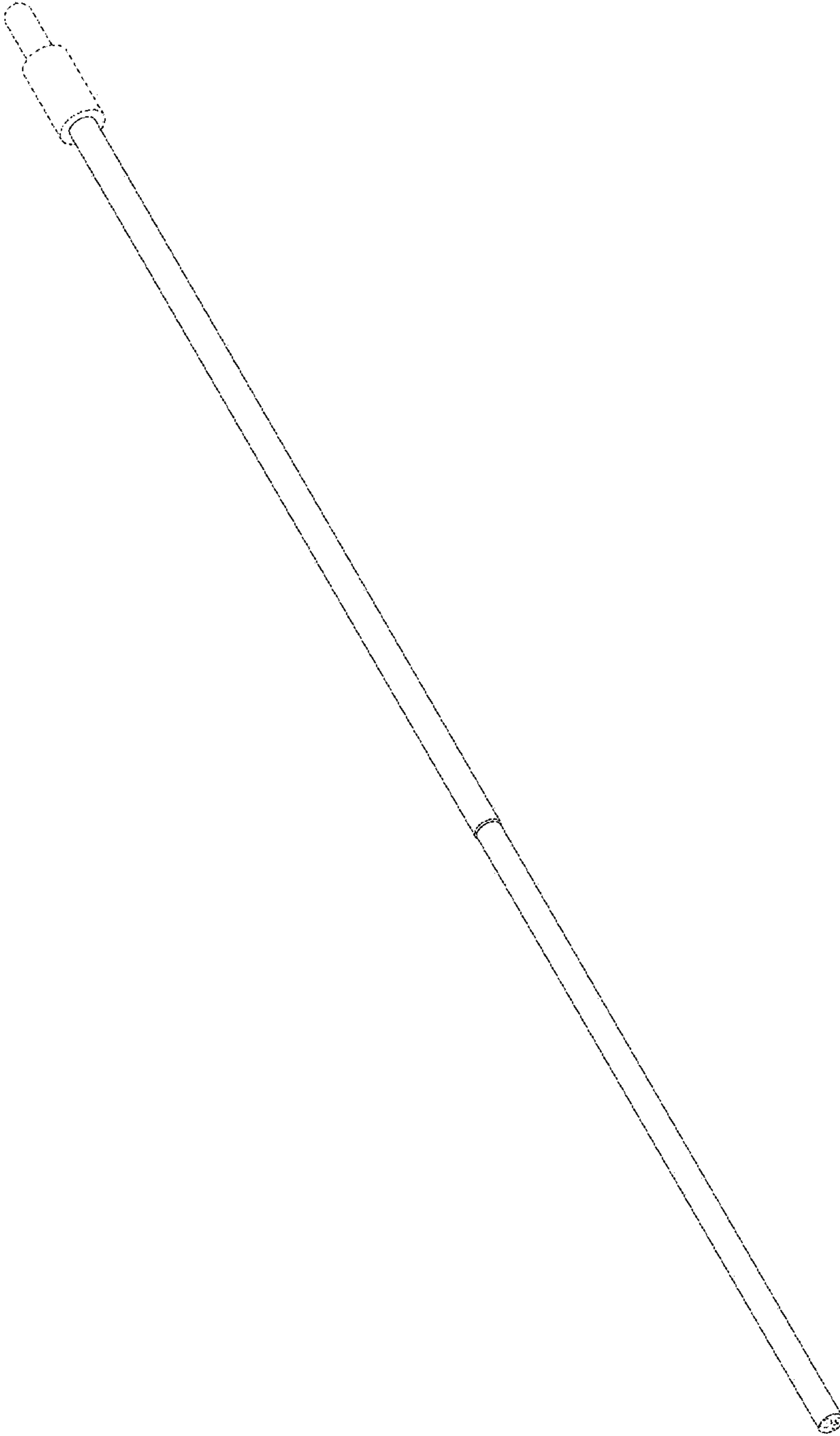

FIG. 16

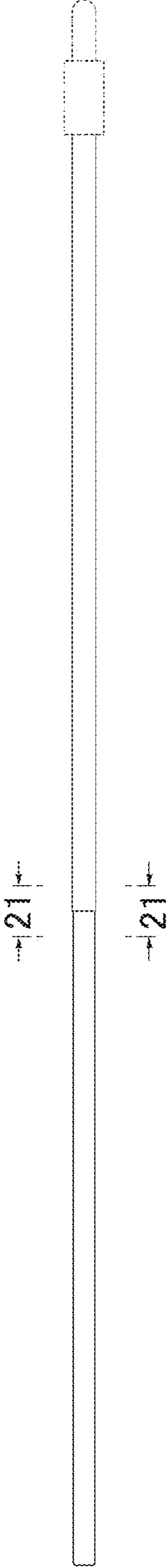

FIG. 17

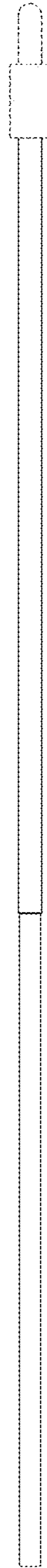

FIG. 18



FIG. 19



FIG. 20

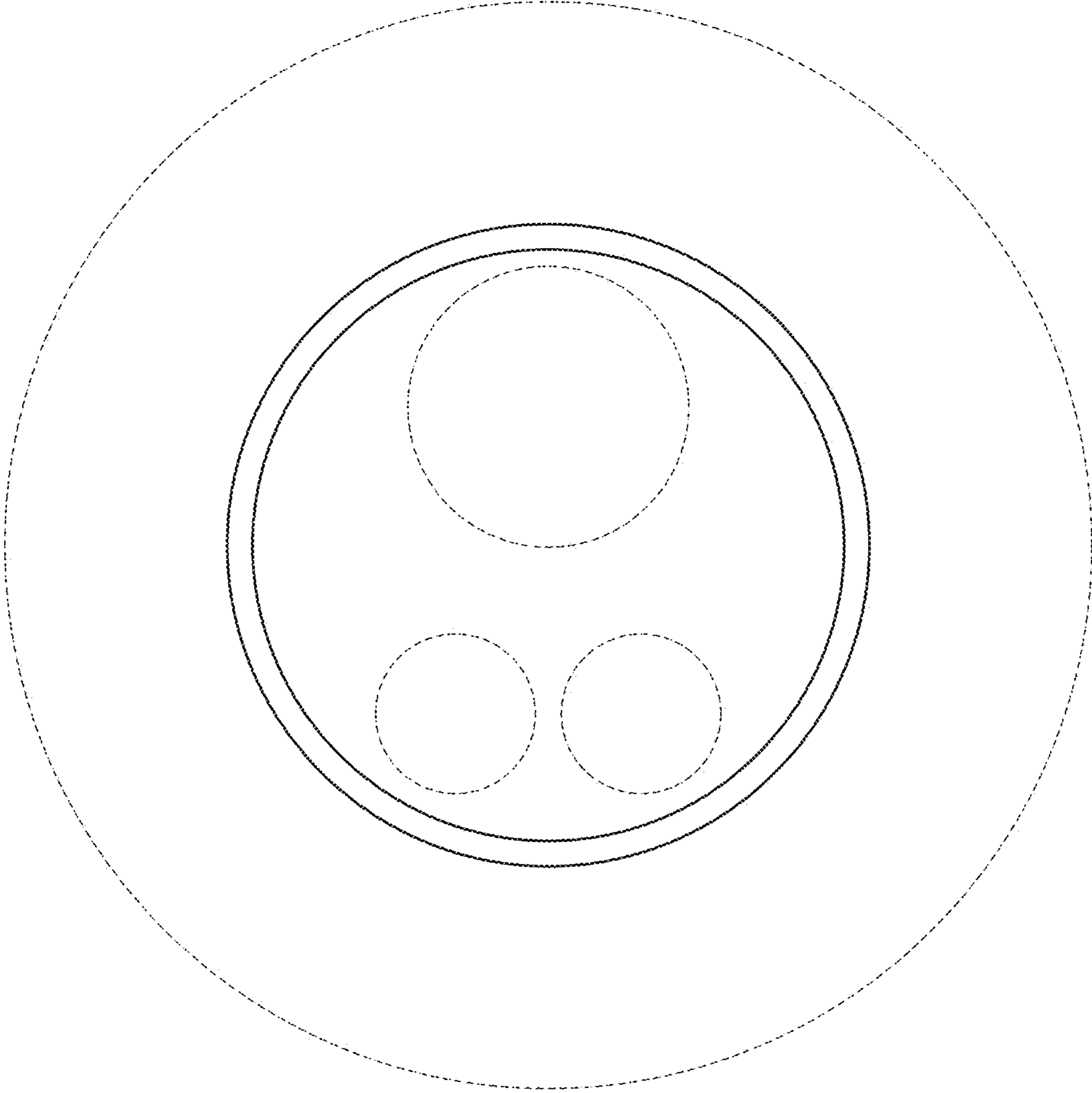

FIG. 21

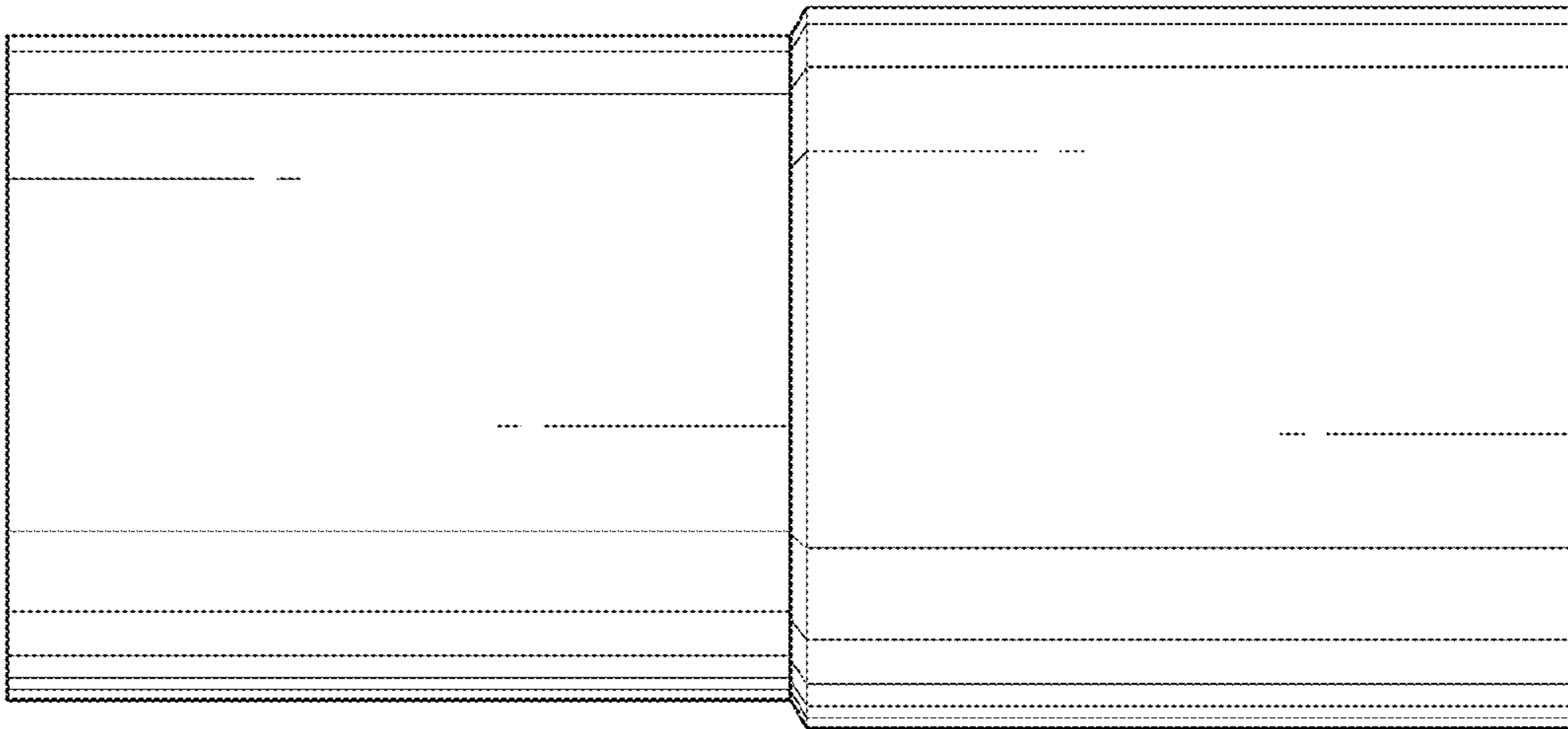

FIG. 22



FIG. 23

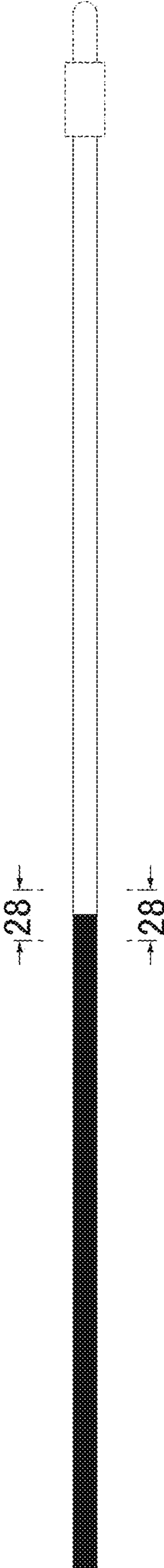

FIG. 24

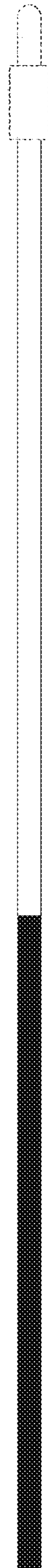

FIG. 25



FIG. 26



FIG. 27

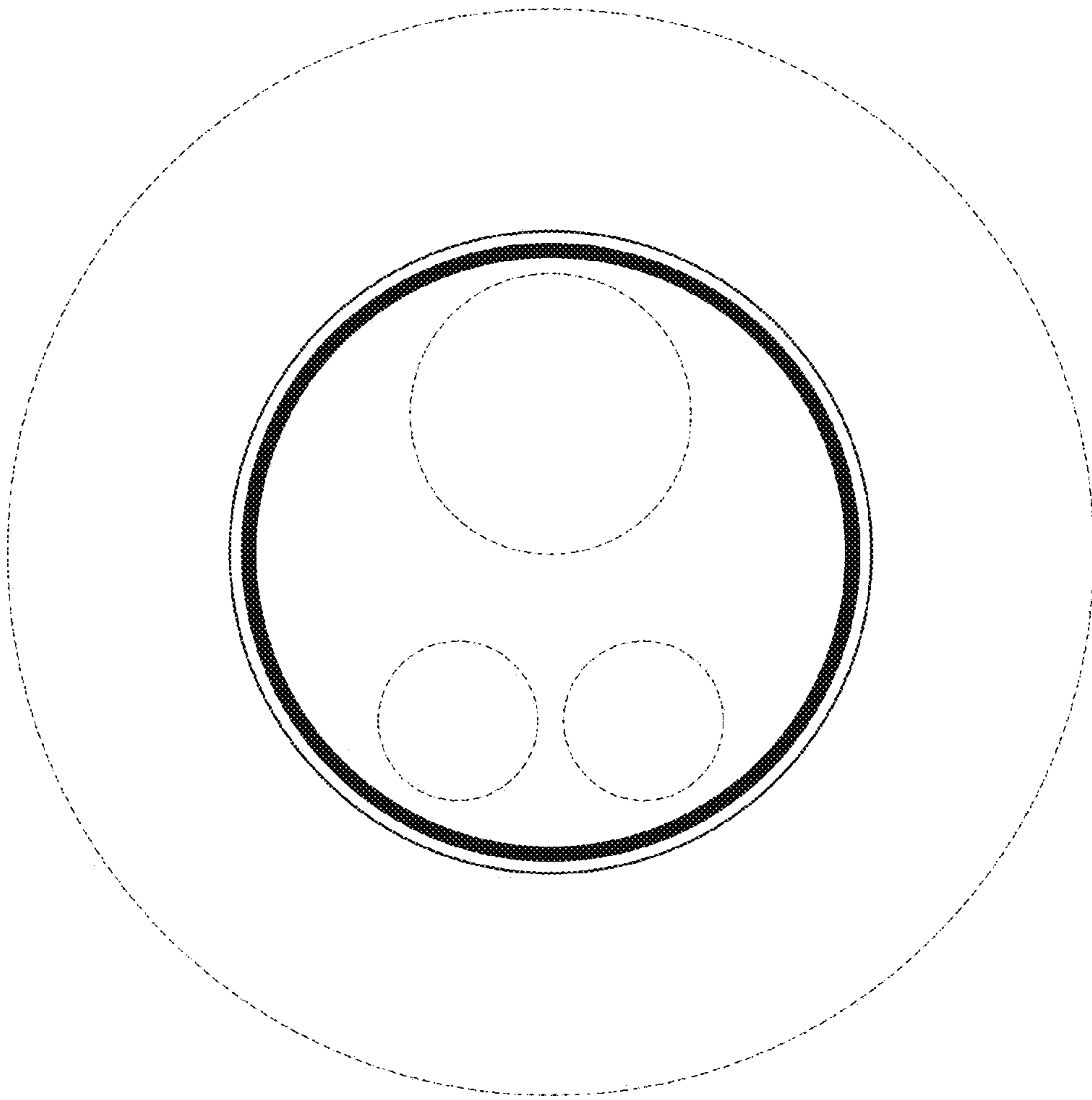

FIG. 28

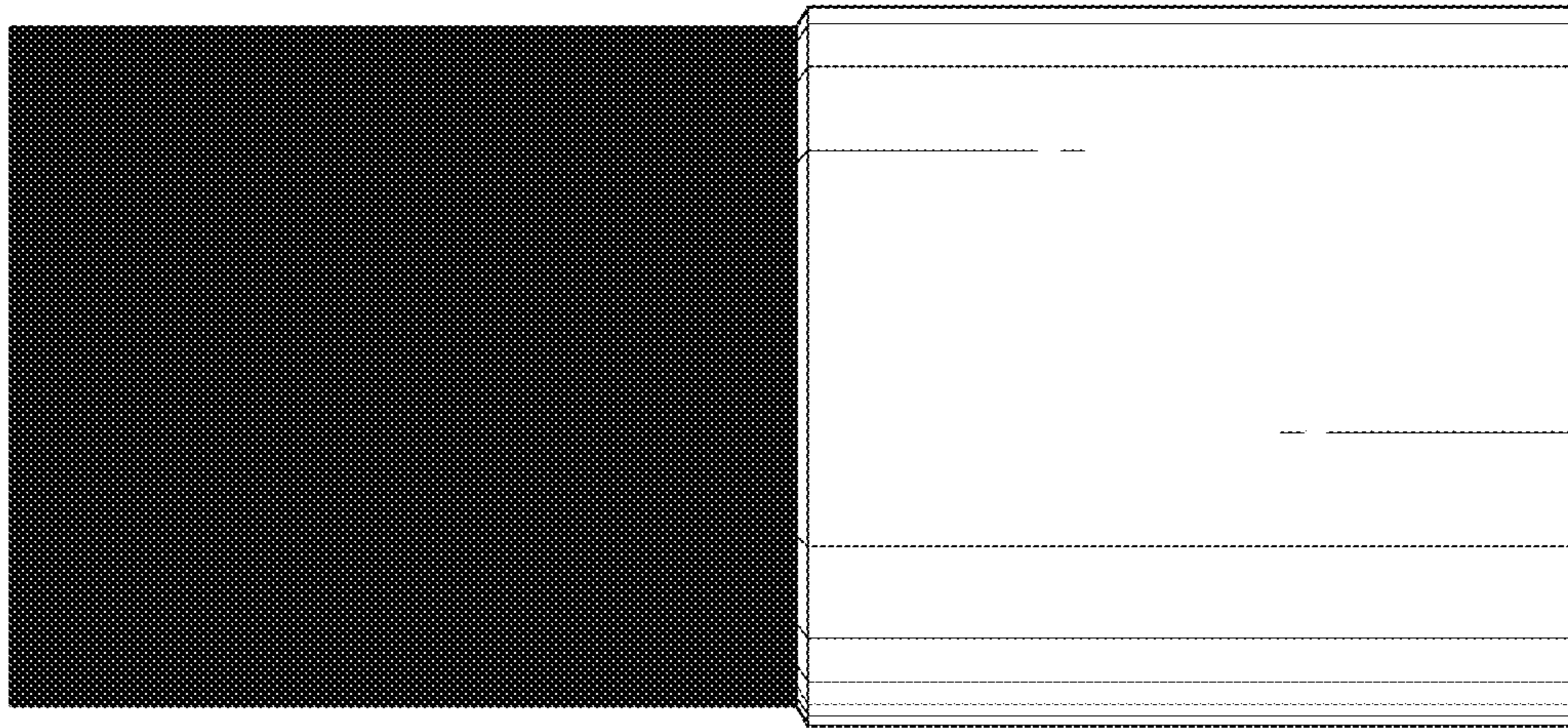

FIG. 29

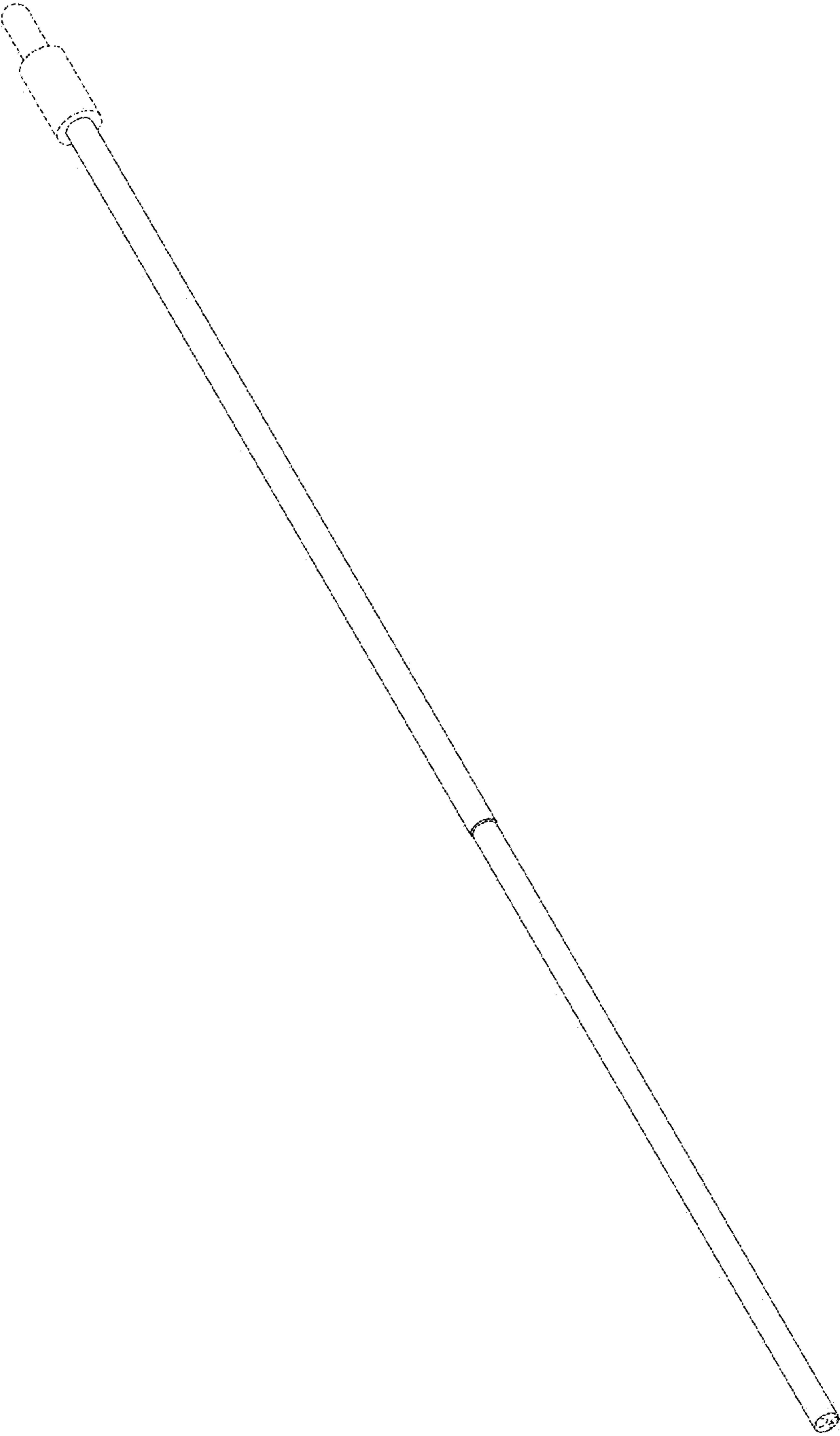

FIG. 30

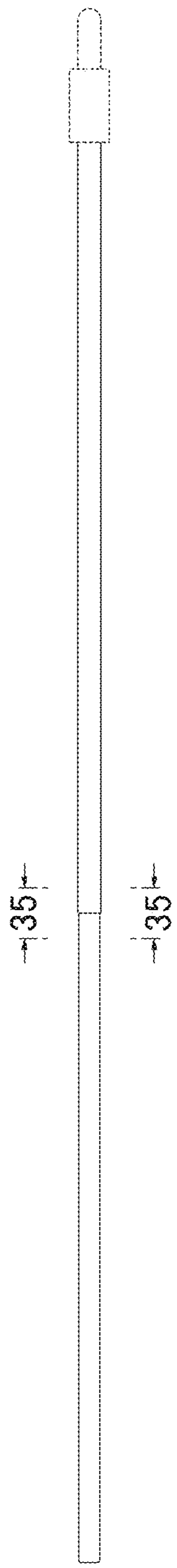

FIG. 31

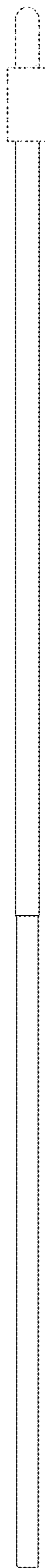

FIG. 32



FIG. 33



FIG. 34

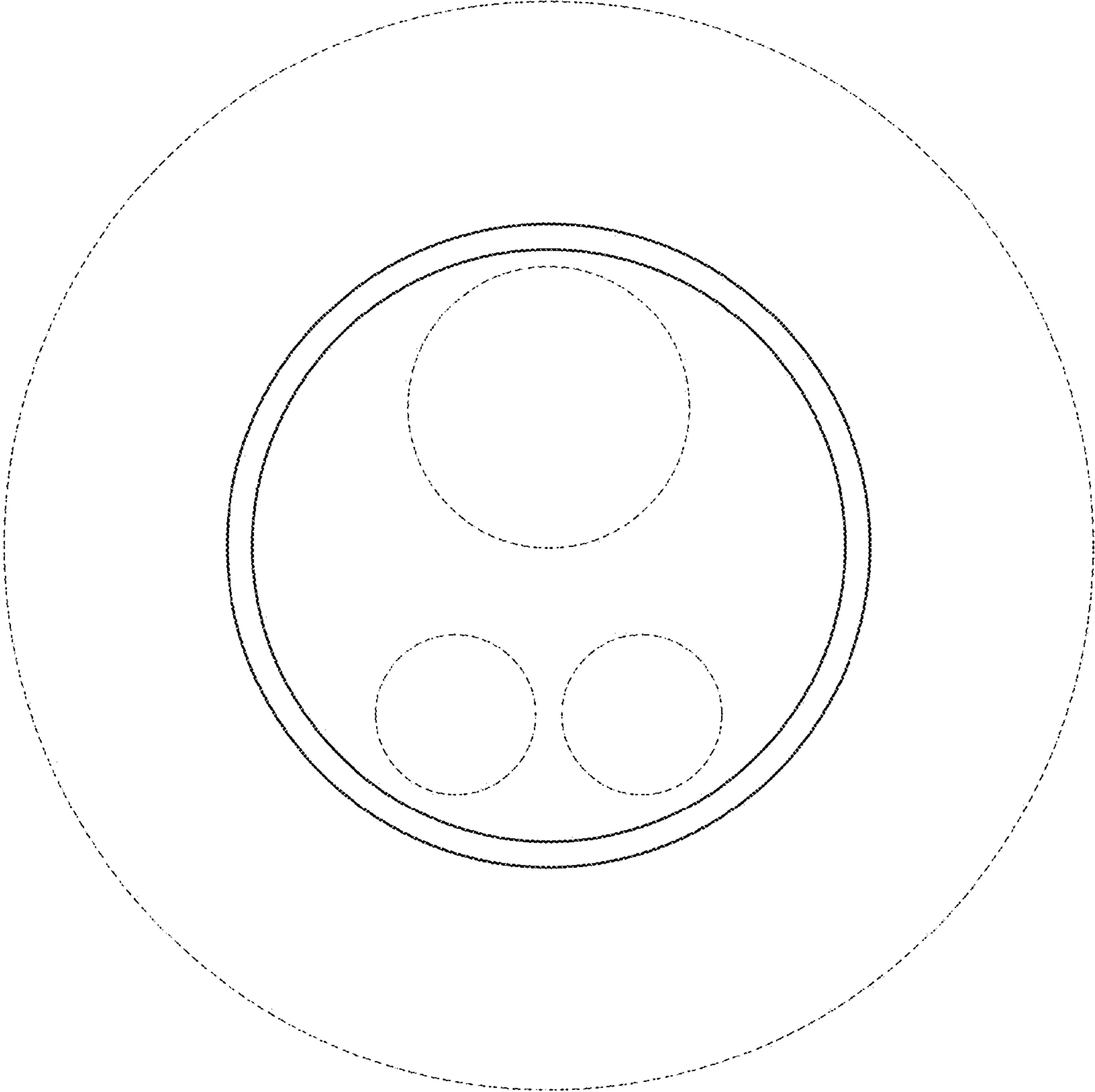

FIG. 35

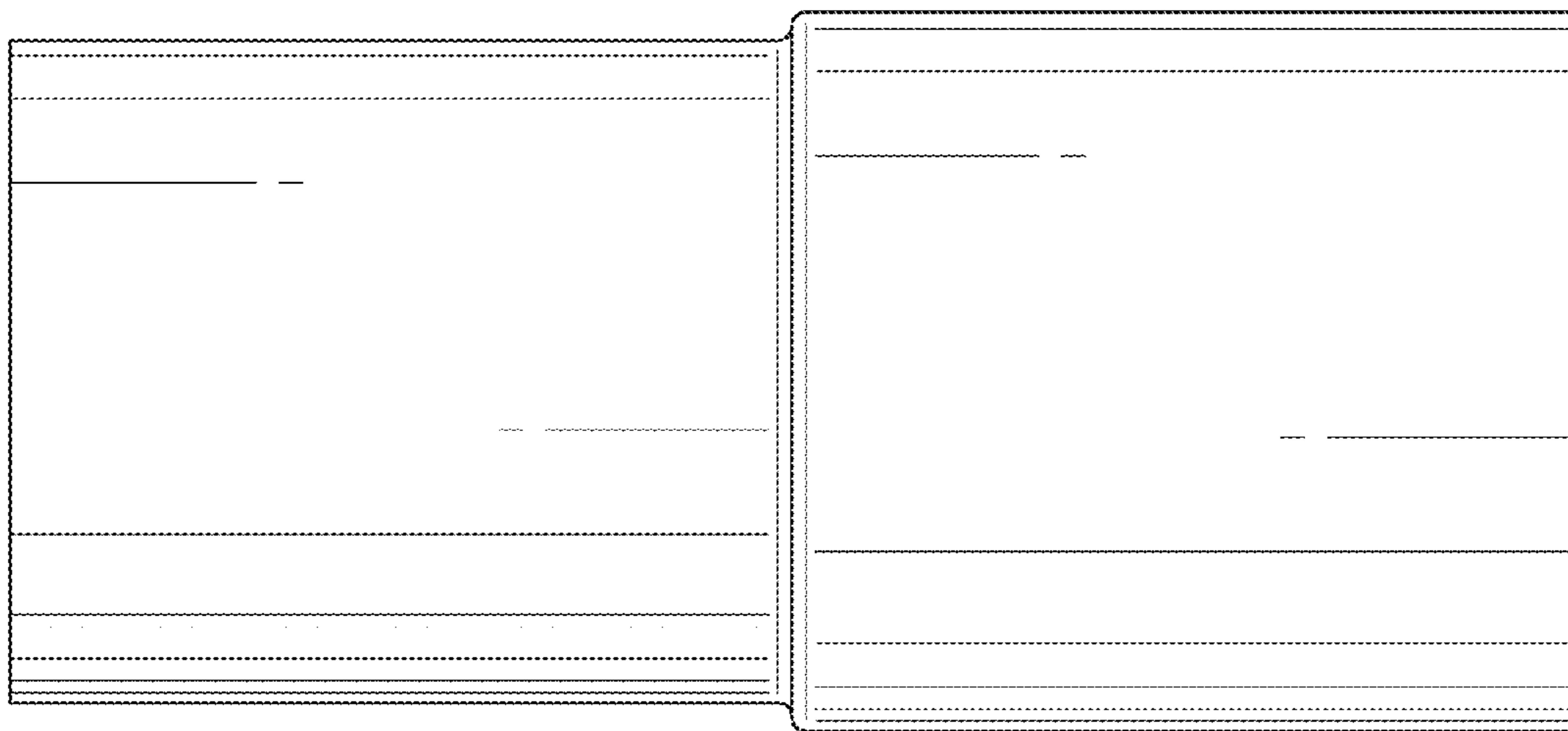

FIG. 36



FIG. 37

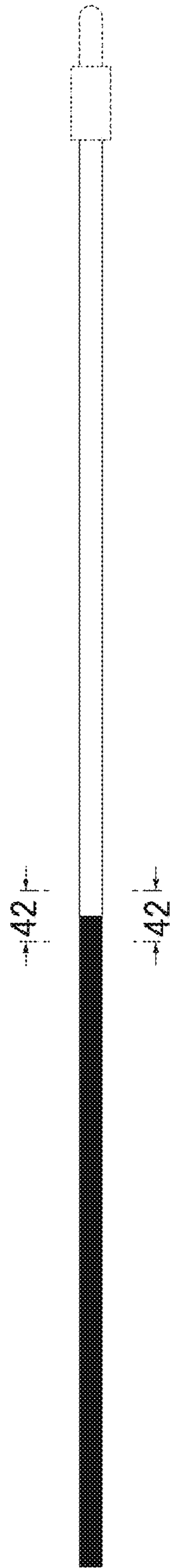

FIG. 38

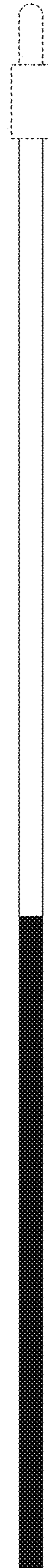

FIG. 39



FIG. 40



FIG. 41

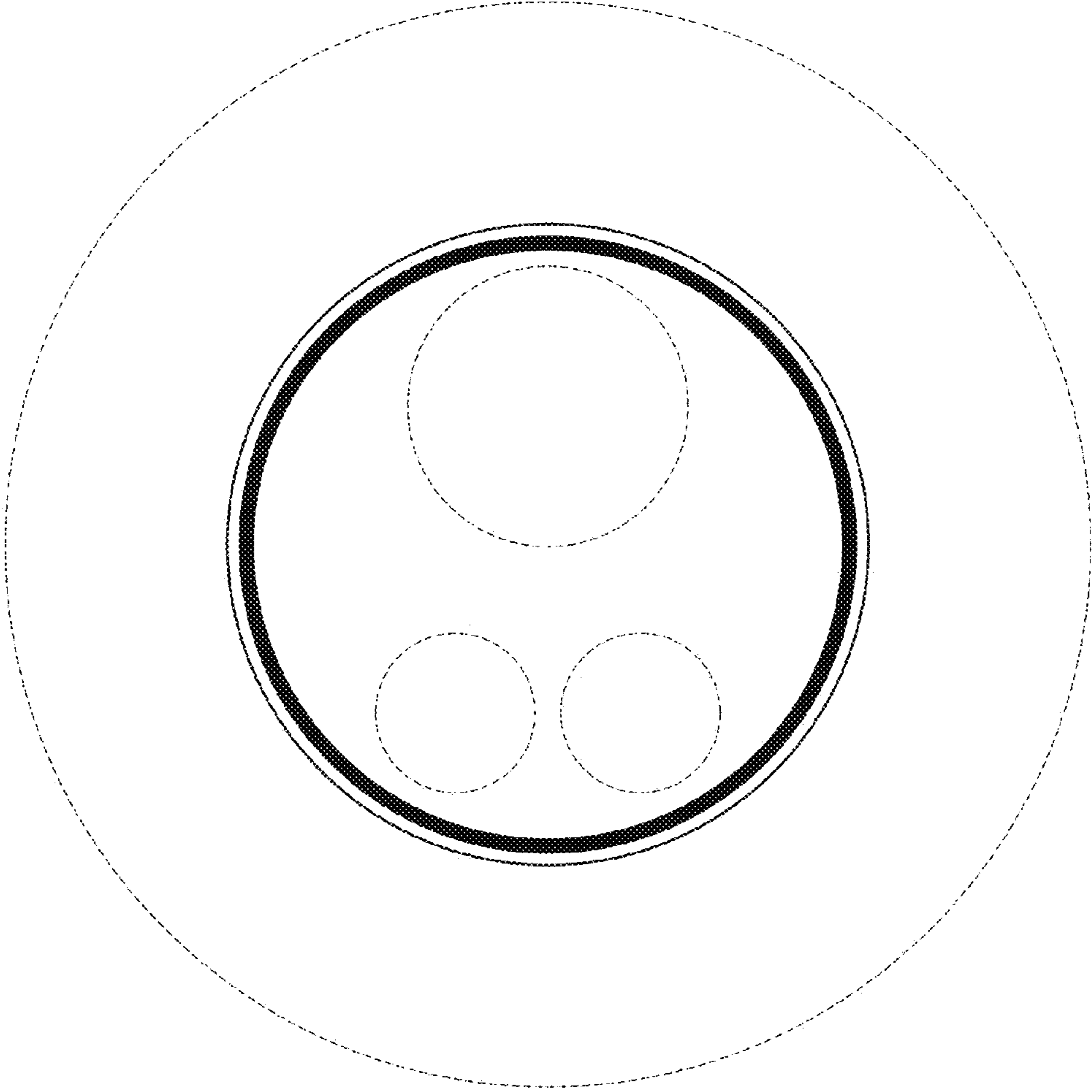

FIG. 42

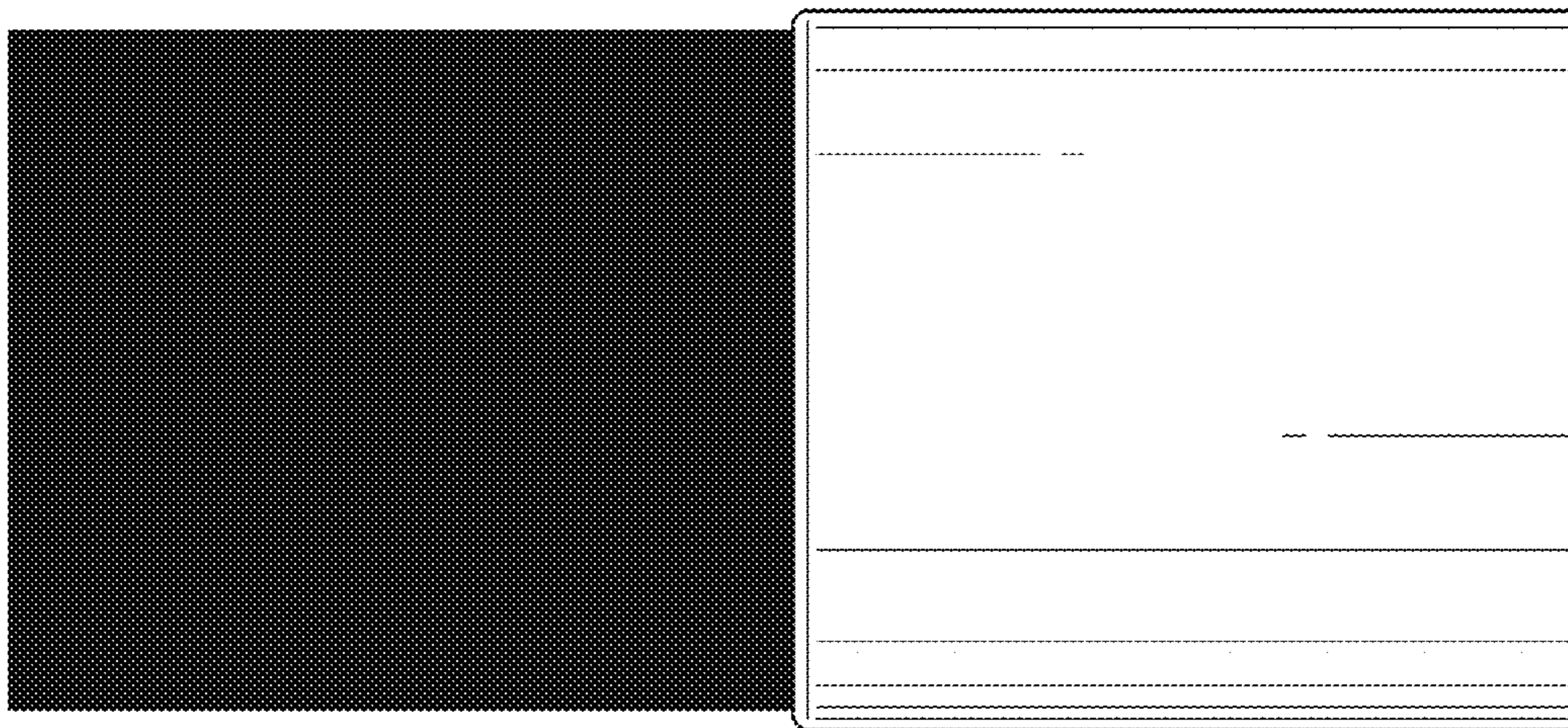

FIG. 43

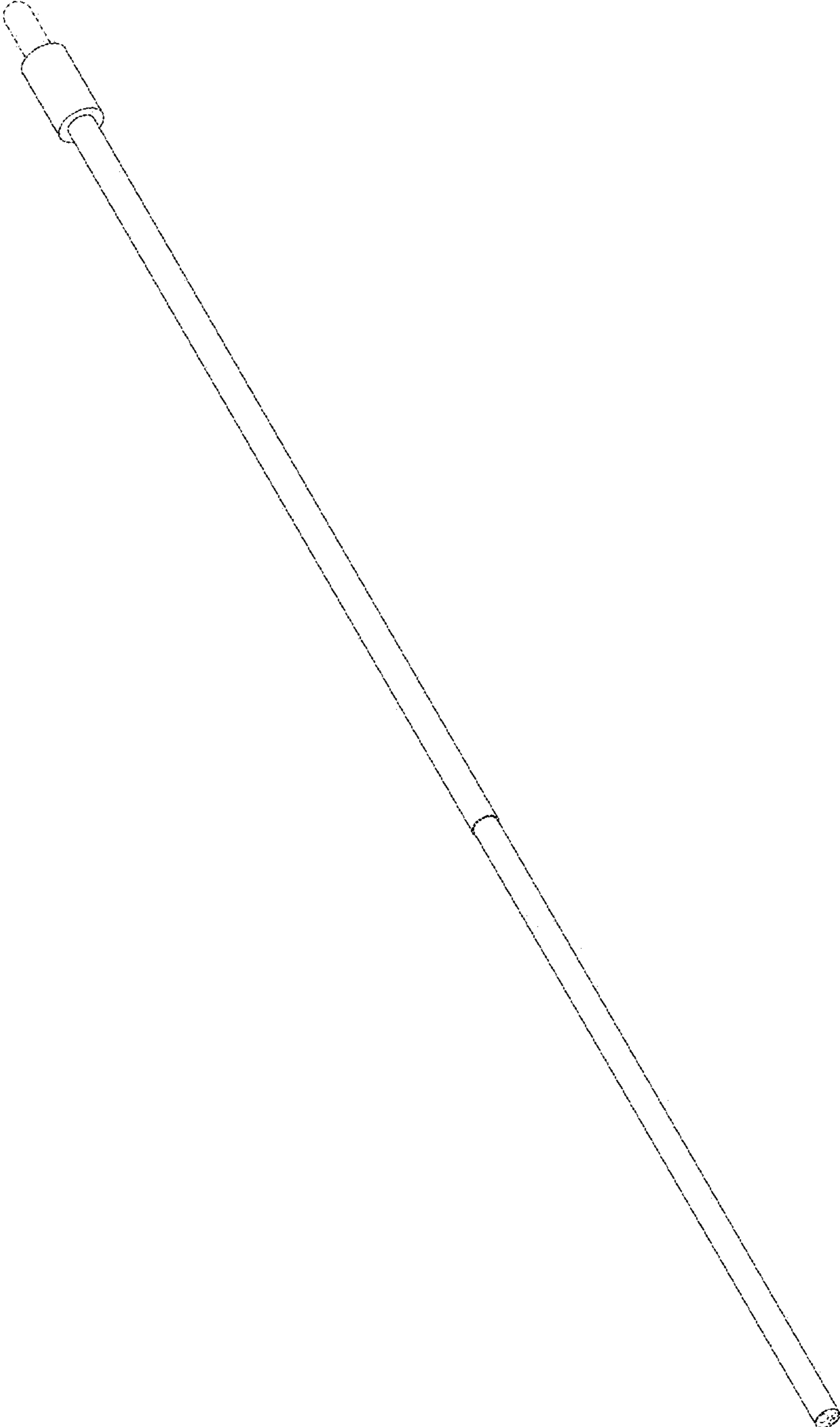

FIG. 44

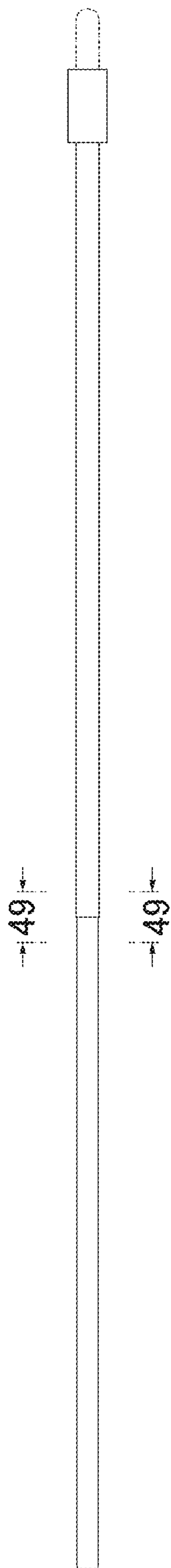

FIG. 45

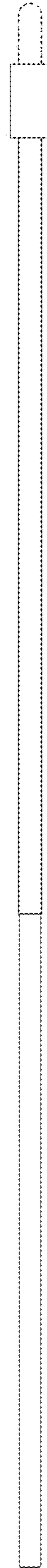

FIG. 46



FIG. 47



FIG. 48

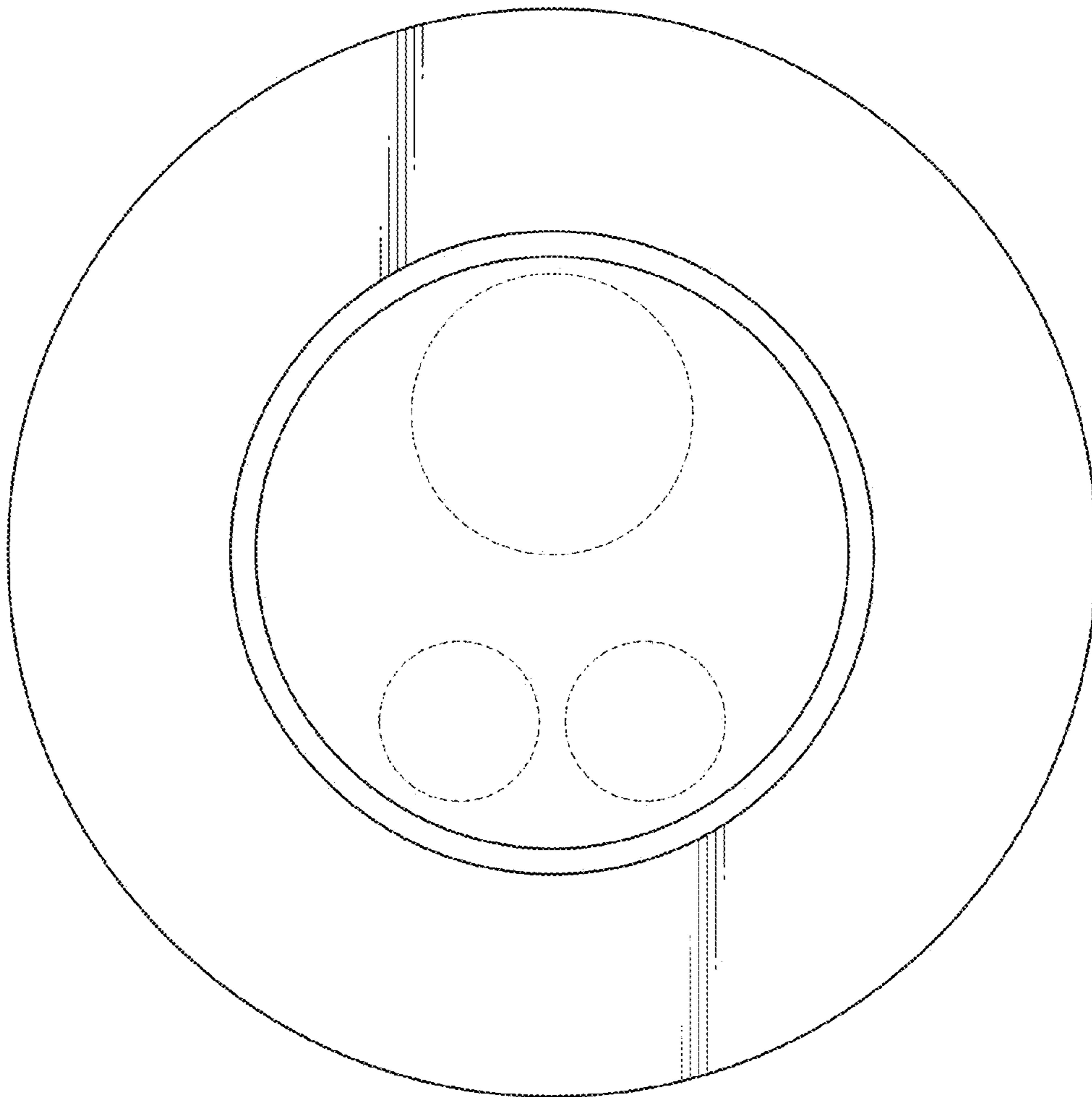

FIG. 49

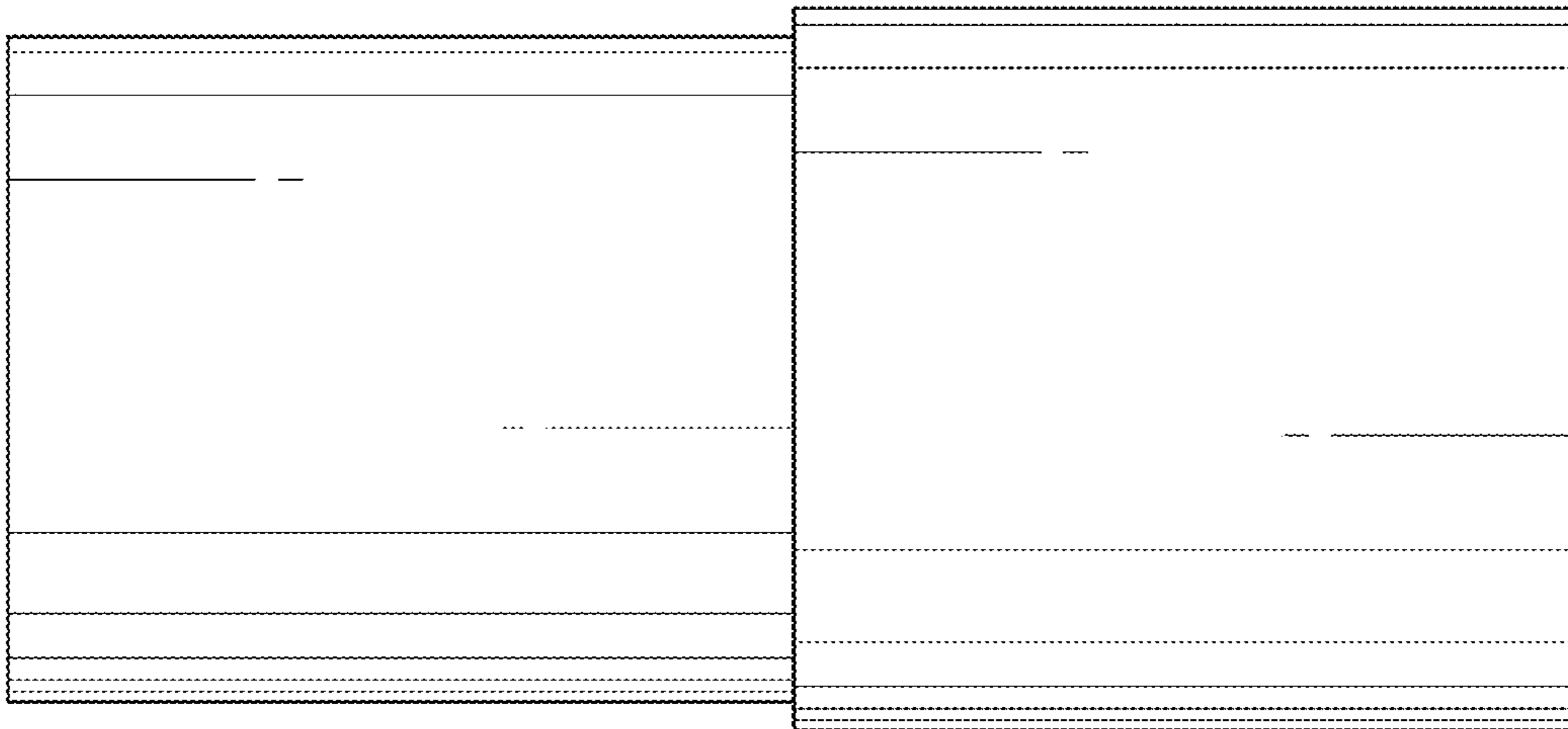

FIG. 50



FIG. 51

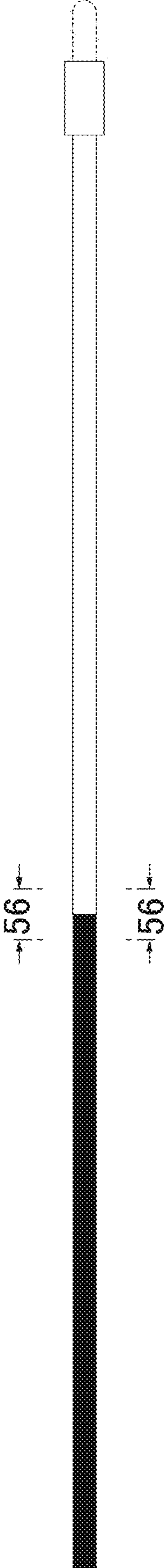

FIG. 52

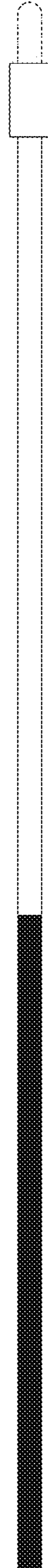

FIG. 53



FIG. 54



FIG. 55

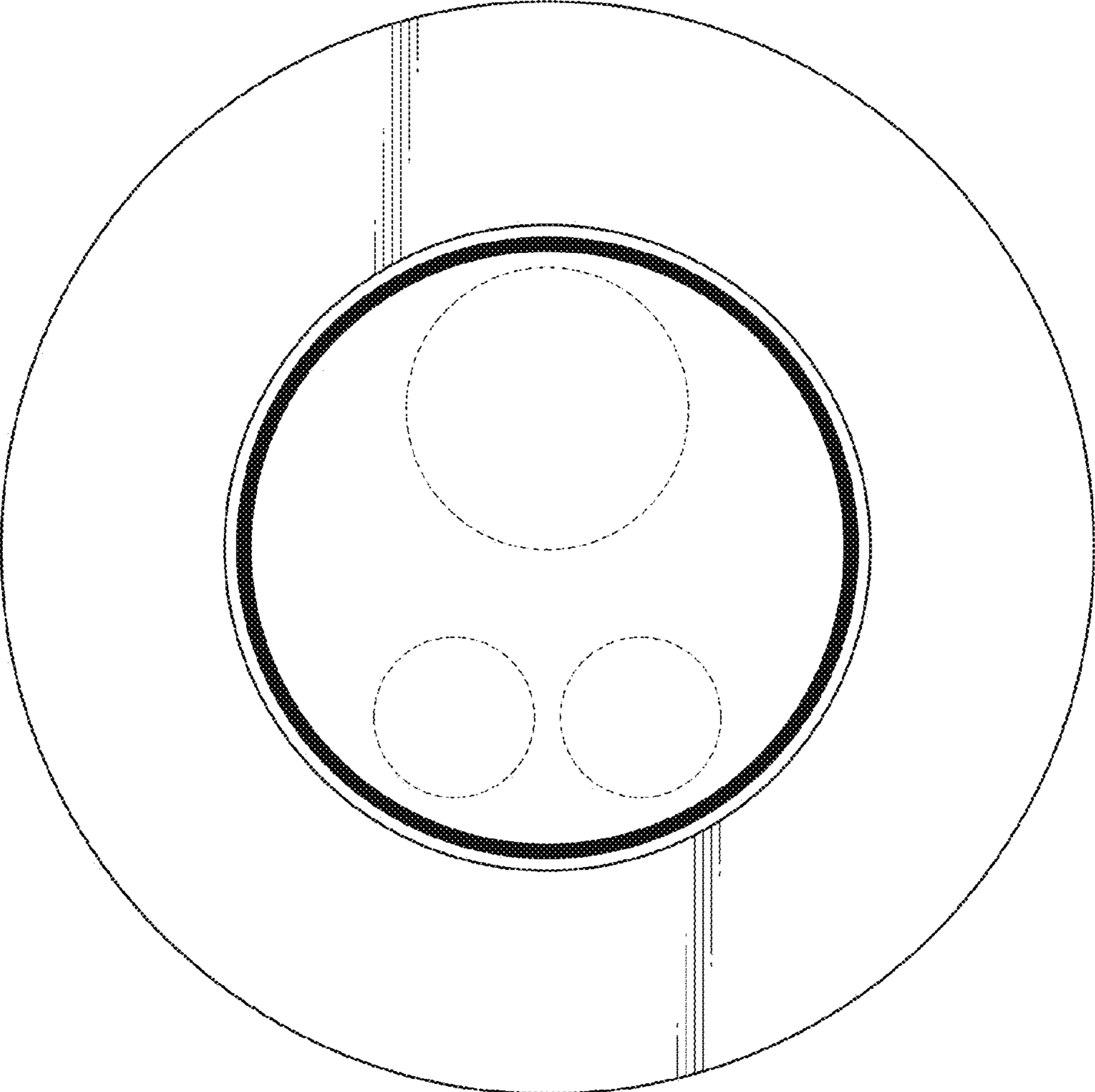

FIG. 56

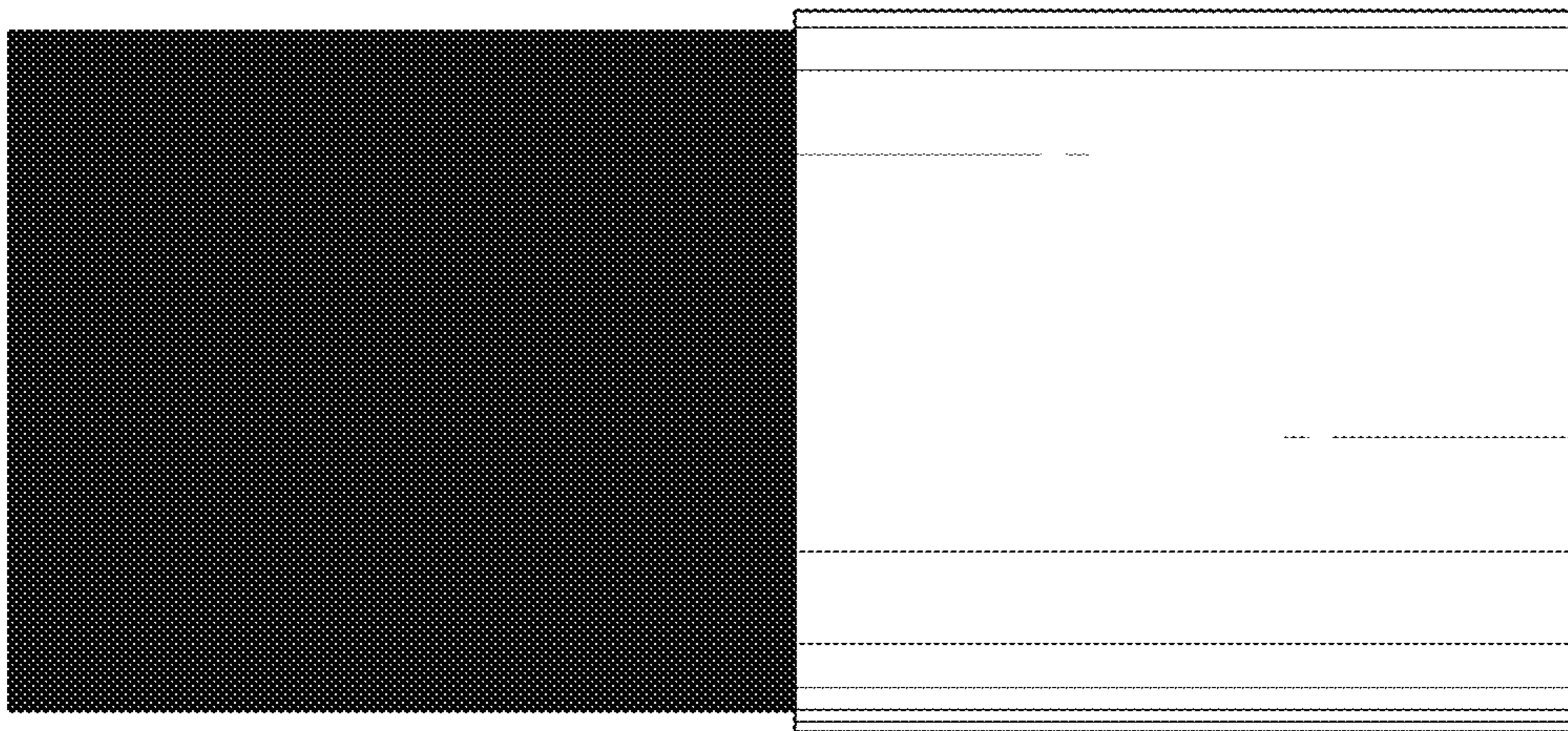

FIG. 57

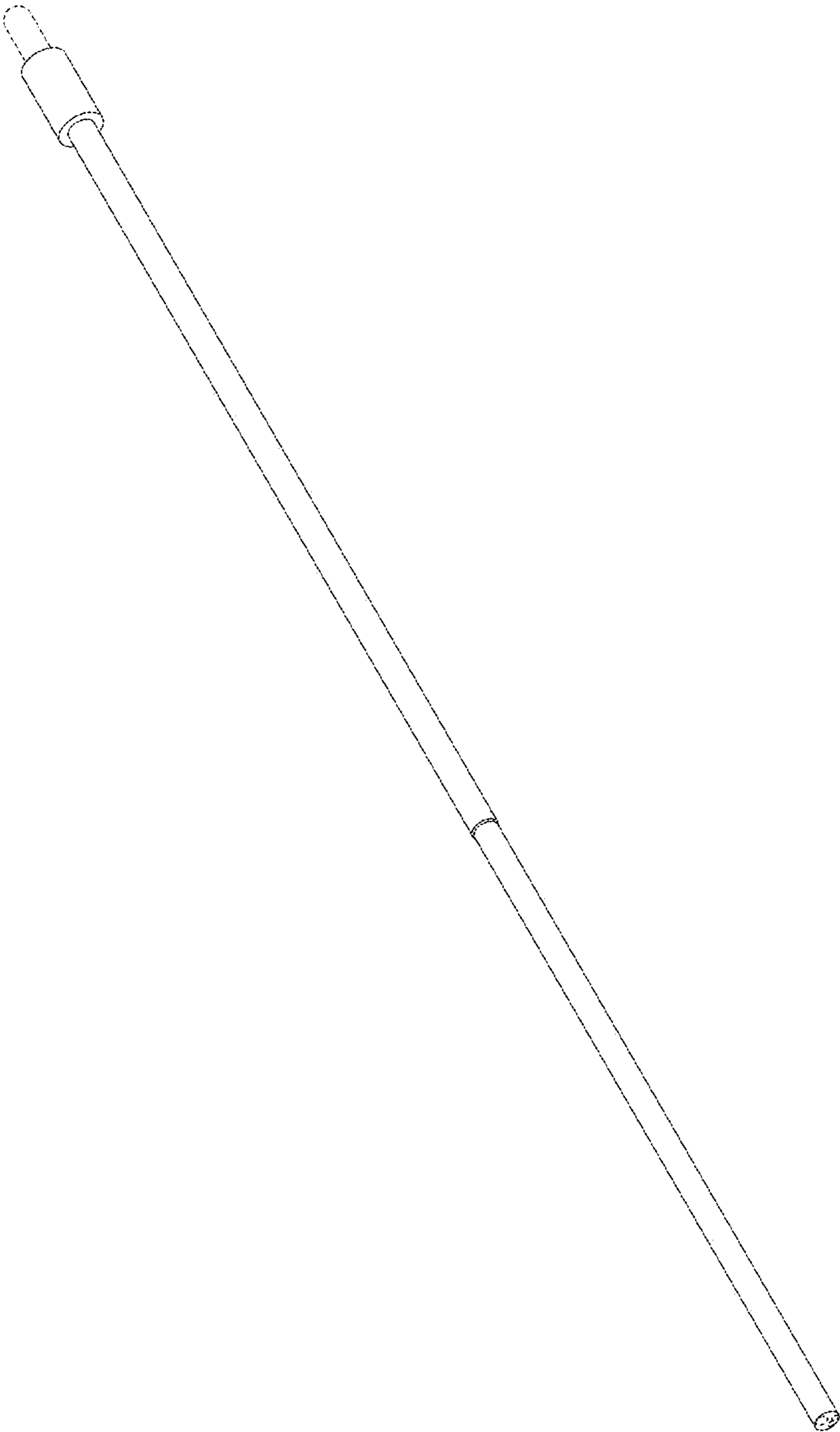

FIG. 58

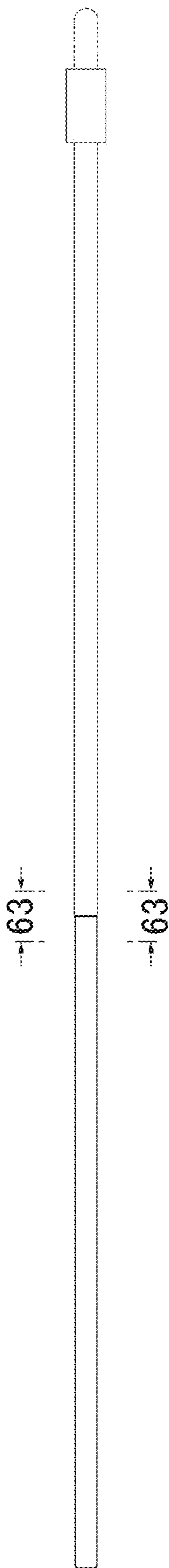

FIG. 59

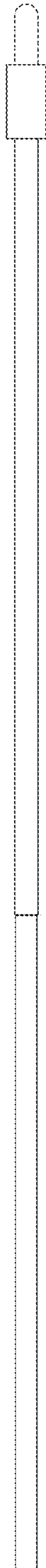

FIG. 60



FIG. 61



FIG. 62

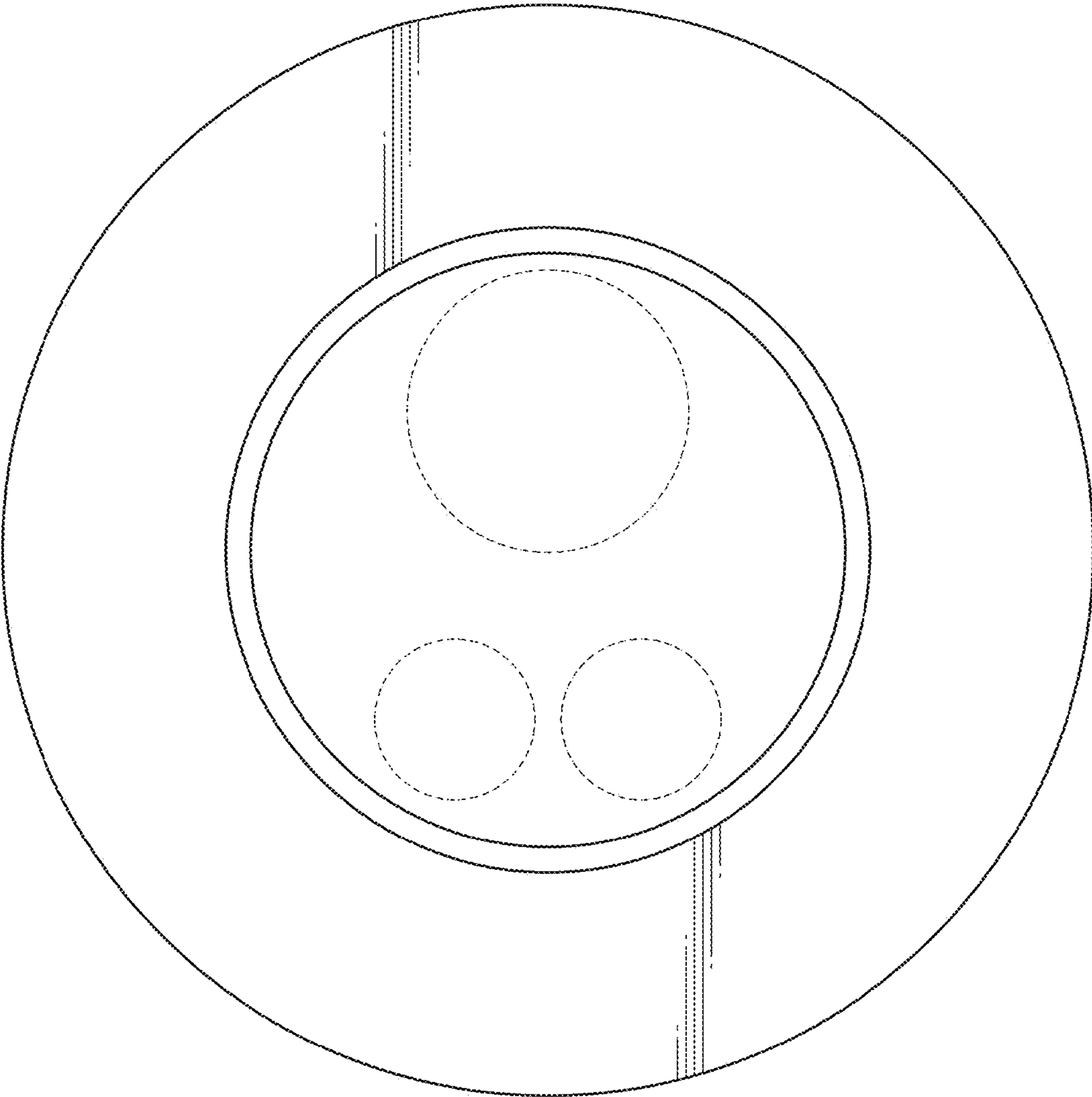

FIG. 63

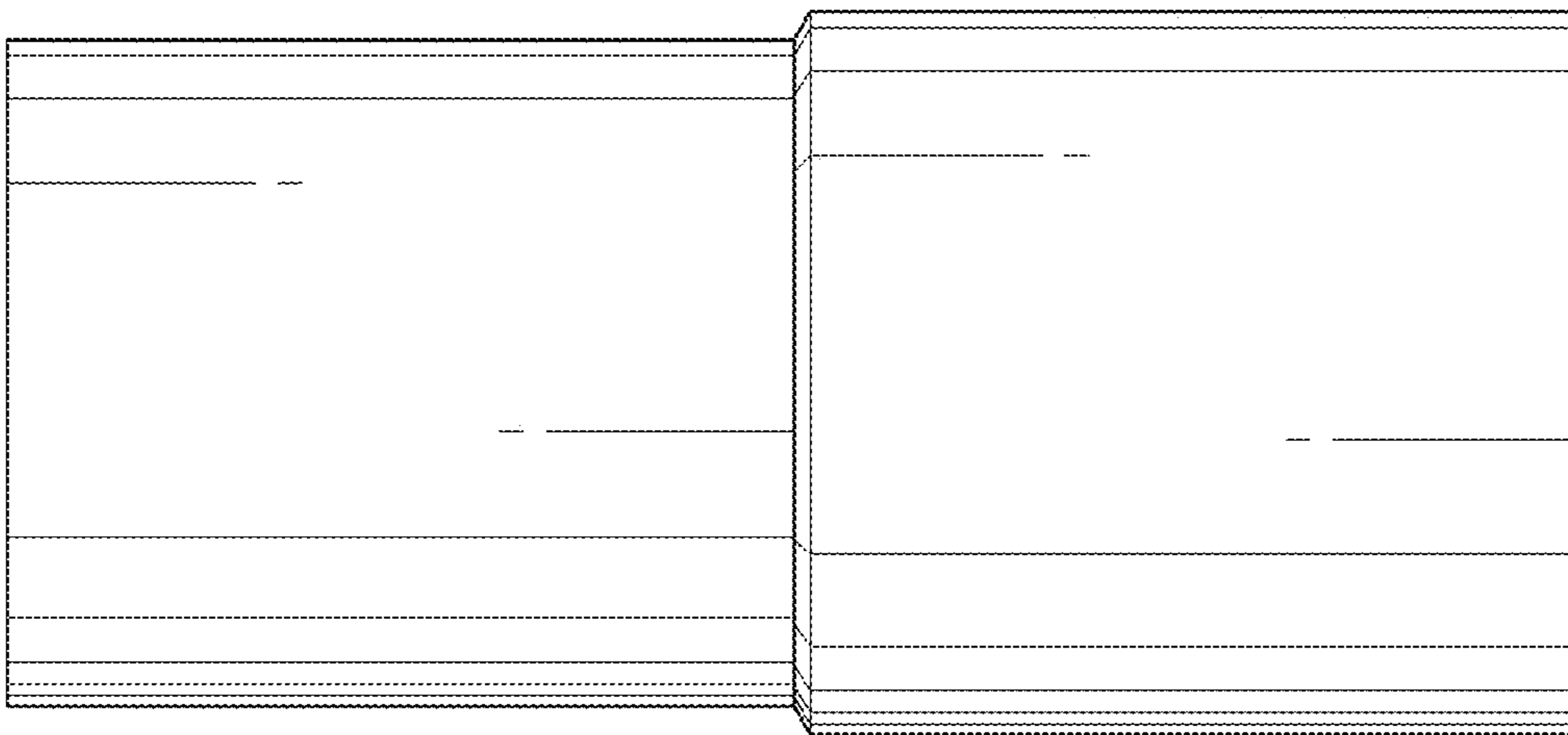

FIG. 64



FIG. 65

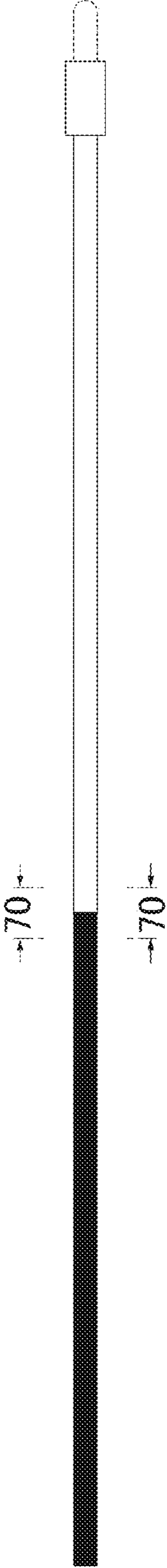

FIG. 66

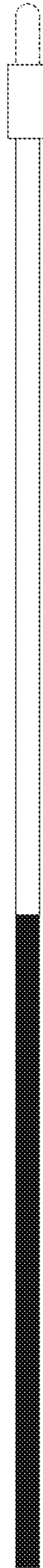

FIG. 67



FIG. 68



FIG. 69

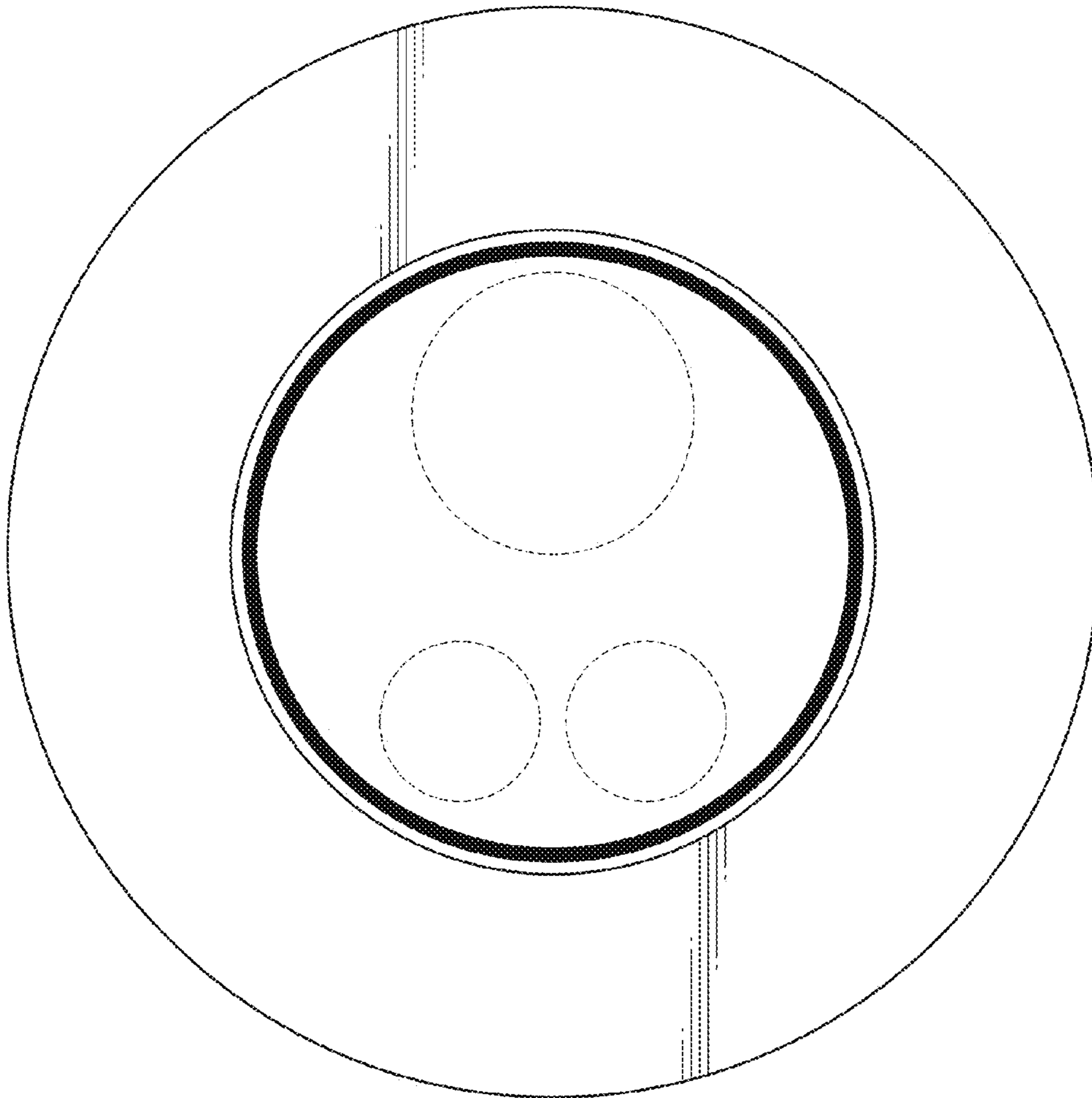

FIG. 70

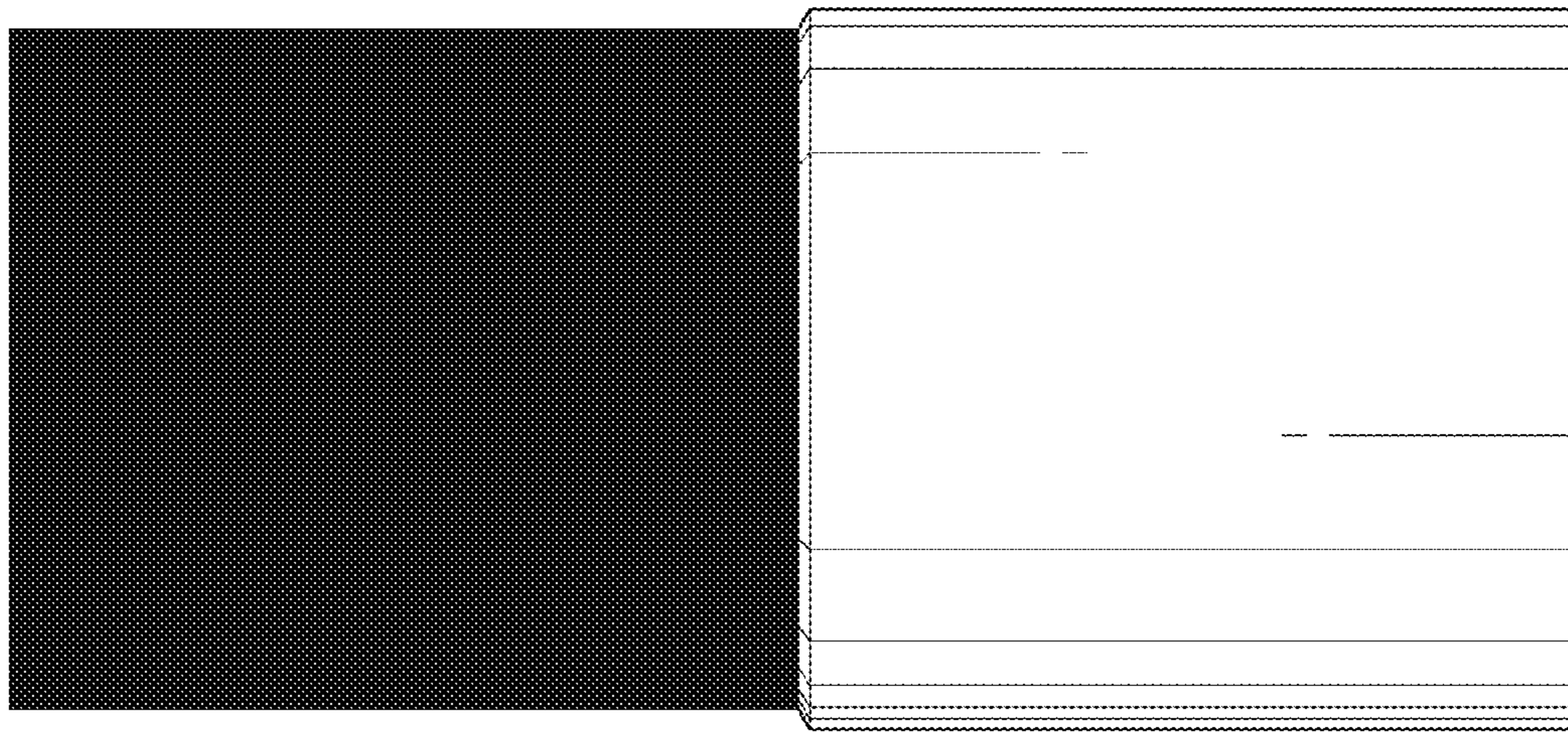

FIG. 71

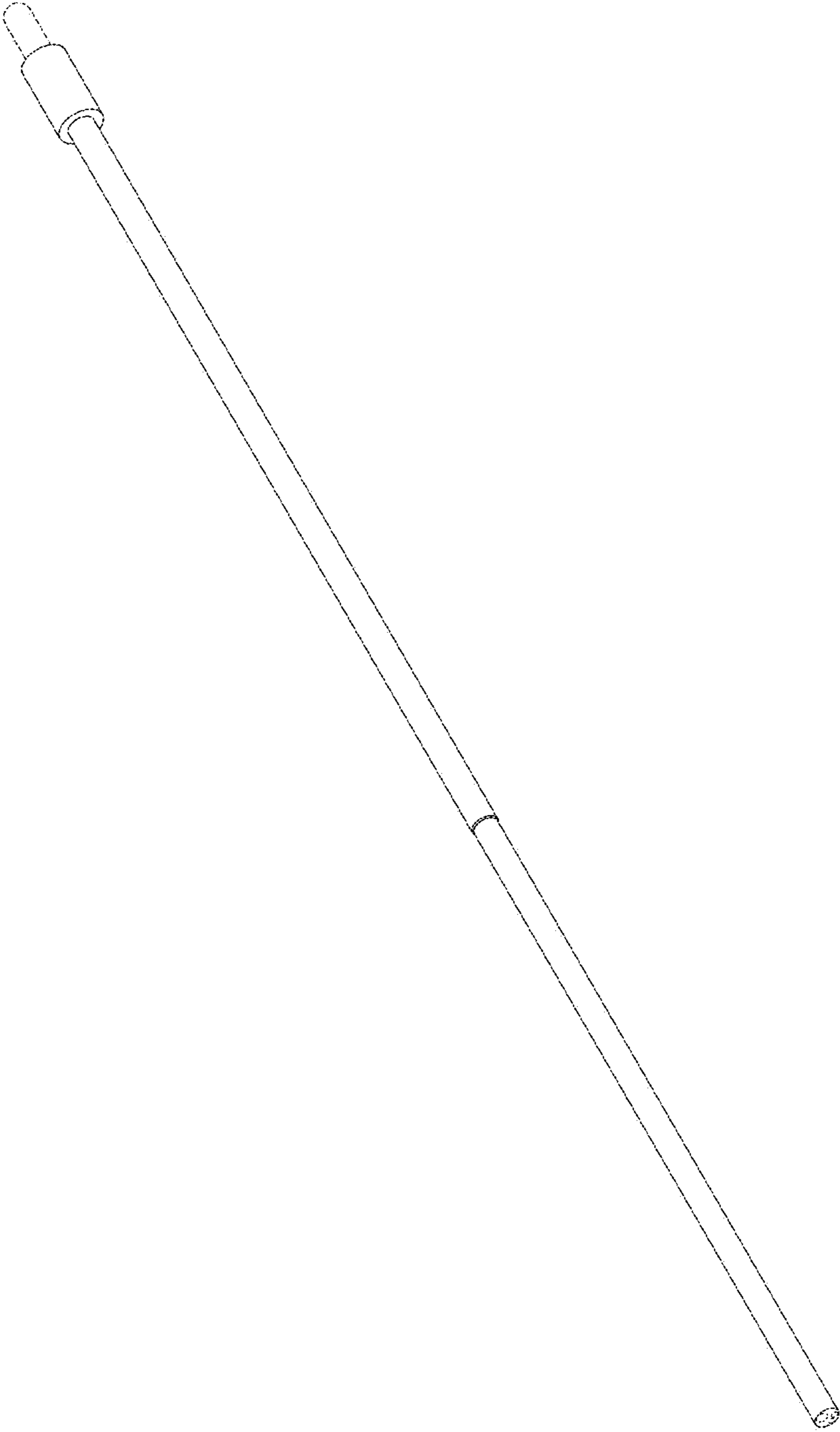

FIG. 72

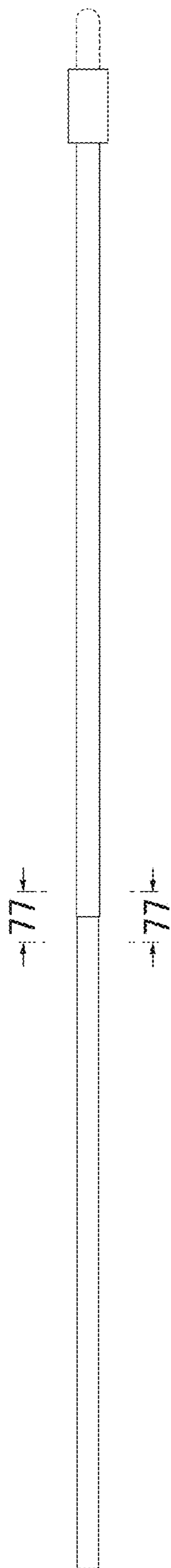

FIG. 73

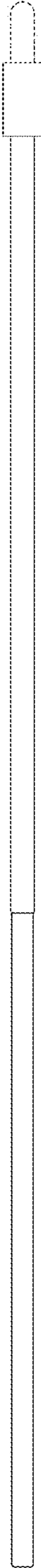

FIG. 74



FIG. 75



FIG. 76

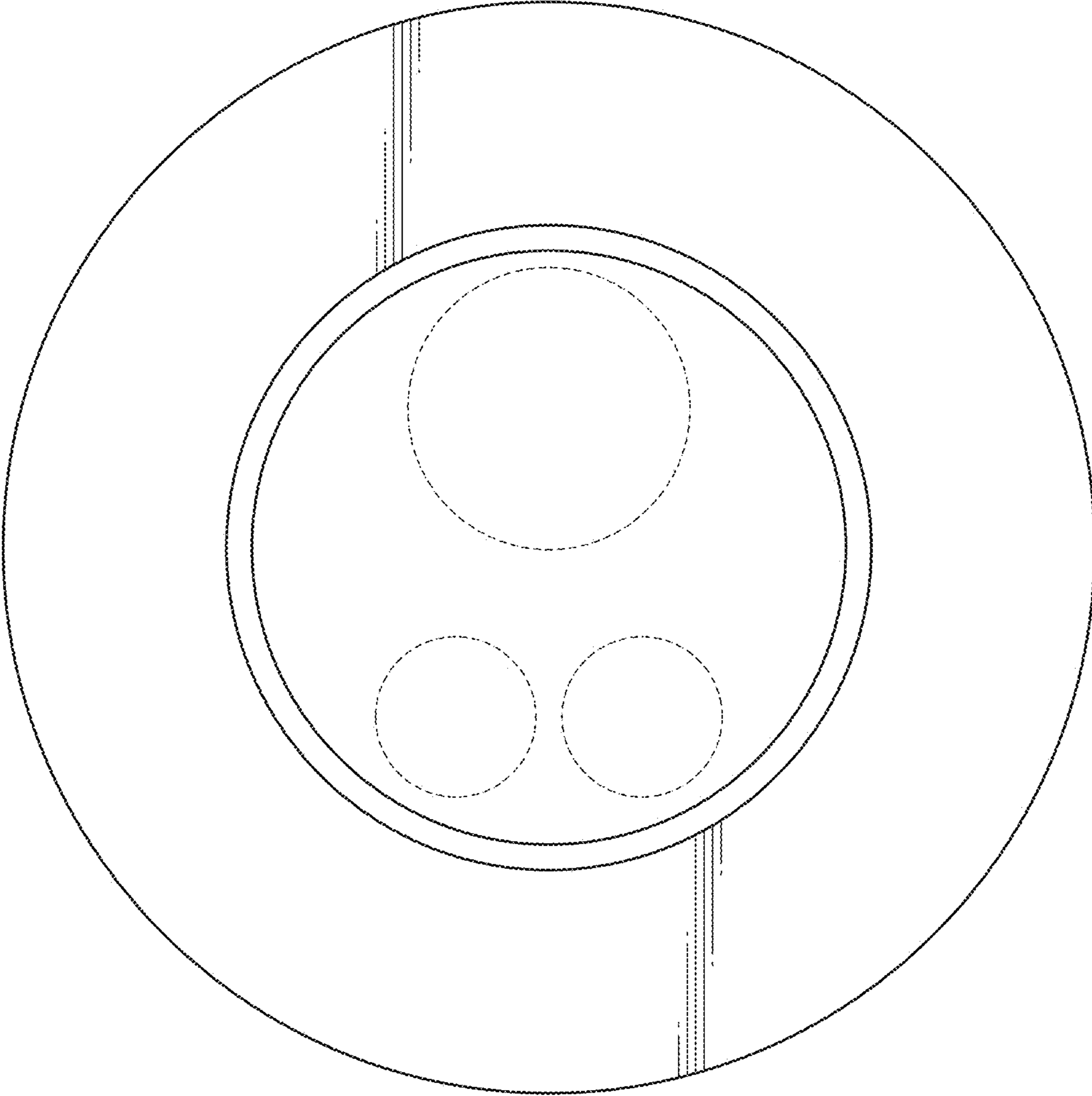

FIG. 77

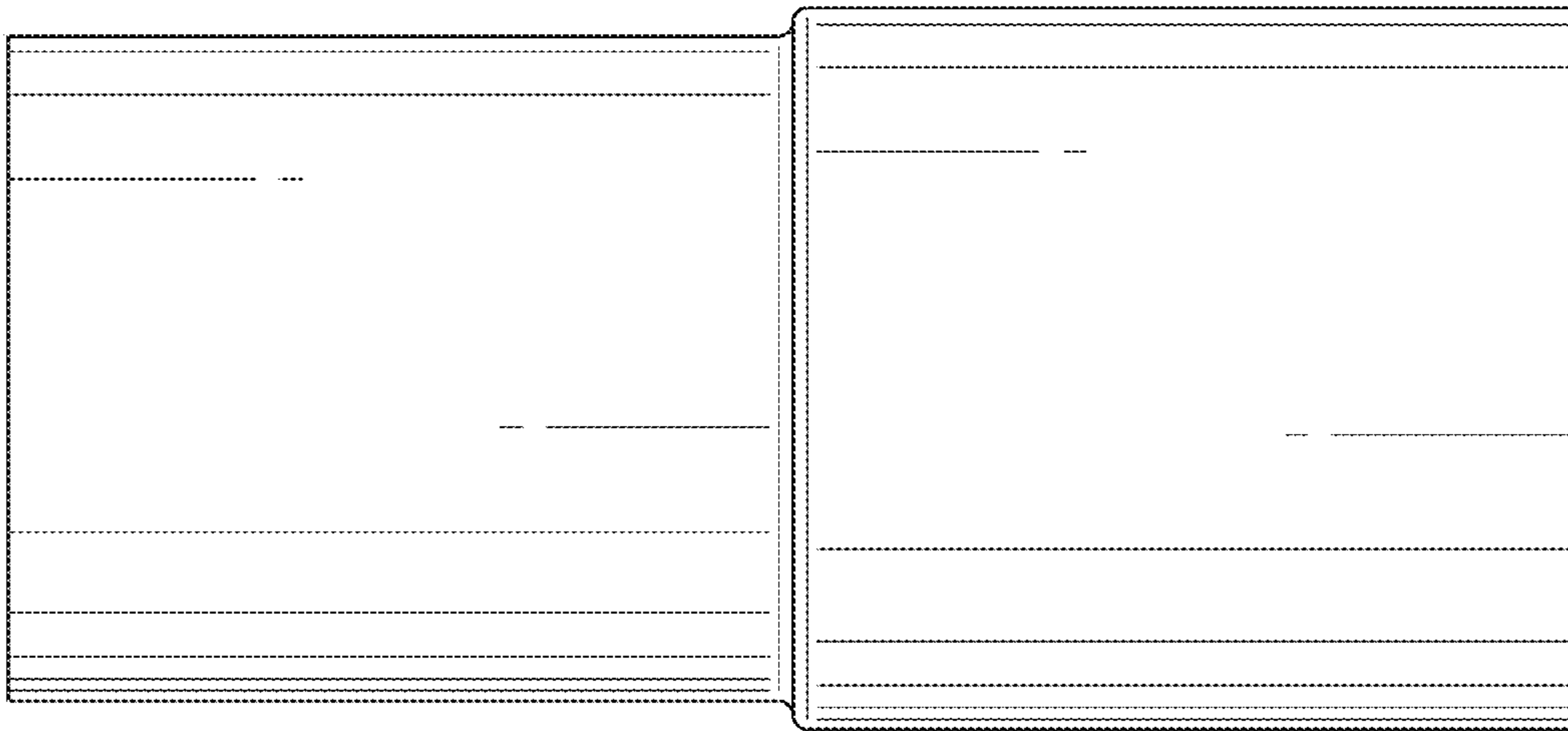

FIG. 78



FIG. 79

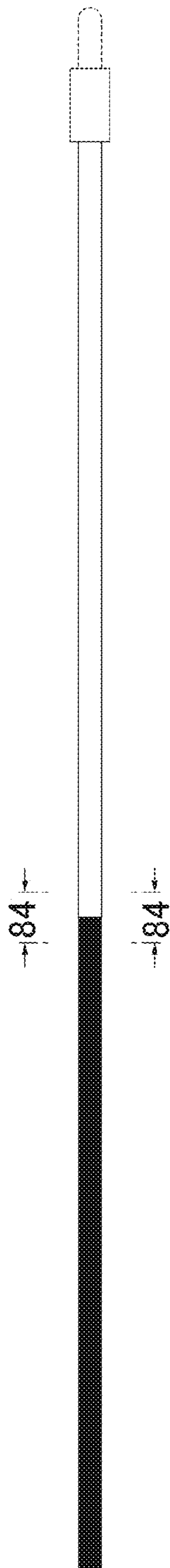

FIG. 80

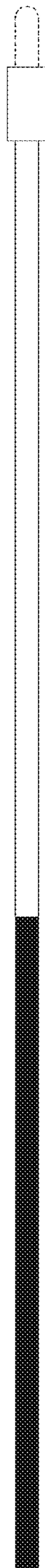

FIG. 81



FIG. 82



FIG. 83

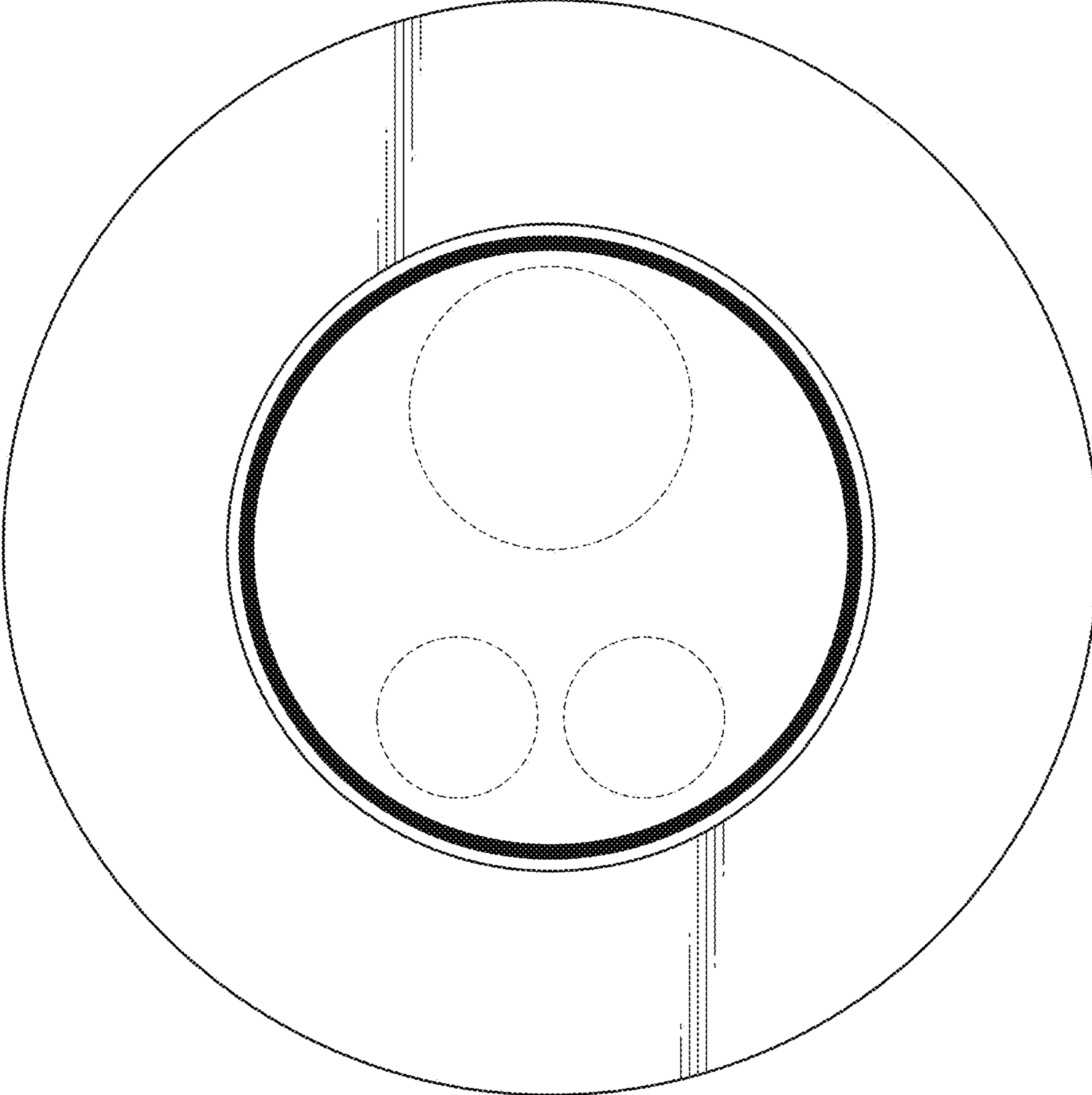

FIG. 84

