



US00D755158S

(12) **United States Design Patent**
Lee et al.

(10) **Patent No.:** **US D755,158 S**
(45) **Date of Patent:** **** May 3, 2016**

- (54) **CAP FOR HEADSET**
- (71) Applicant: **Samsung Electronics Co., Ltd.**,
Suwon-si (KR)
- (72) Inventors: **Ki-Eon Lee**, Seoul (KR); **Seung-Ho Jung**, Seongnam-si (KR); **Jin-Man Chung**, Gwacheon-si (KR)
- (73) Assignee: **Samsung Electronics Co., Ltd.**,
Suwon-si (KR)
- (**) Term: **14 Years**
- (21) Appl. No.: **29/517,497**
- (22) Filed: **Feb. 13, 2015**
- (30) **Foreign Application Priority Data**
Aug. 28, 2014 (KR) 30-2014-0042146
- (51) **LOC (10) Cl.** **14-01**
- (52) **U.S. Cl.**
USPC **D14/205; D14/223**
- (58) **Field of Classification Search**
USPC D14/205, 223; D24/174; 181/129, 130,
181/135; 379/430, 431; 381/381, 380, 328,
381/324; 455/90.3, 575.1; 128/866
CPC H04R 1/10
See application file for complete search history.

- (56) **References Cited**
U.S. PATENT DOCUMENTS
2,403,418 A * 7/1946 Volkman H04R 1/1008
181/129
2,719,523 A * 10/1955 Von Gierke A61F 11/10
128/864
3,496,306 A * 2/1970 Pollak H04R 25/608
29/896.21
3,598,928 A * 8/1971 Hickox H04R 25/608
200/292
D340,286 S * 10/1993 Seo D24/174
6,056,082 A * 5/2000 Lindgren A61F 11/12
128/864
D514,094 S * 1/2006 Griffin D14/223

- 7,010,137 B1 * 3/2006 Leedom A61B 5/6817
381/322
- 7,092,543 B1 * 8/2006 Mahoney H04R 25/65
381/322
- D549,222 S * 8/2007 Huang D14/223
- 7,292,823 B2 * 11/2007 Kuo H04M 1/05
379/330
- D564,495 S * 3/2008 Sasaki D14/205
- D579,005 S * 10/2008 Wilhelmsen D14/223
- D587,247 S * 2/2009 Densho D14/223
- D587,681 S * 3/2009 Yanai D14/205
- D610,129 S * 2/2010 Densho D14/223
- D618,219 S * 6/2010 Burgett D14/223
- D621,389 S * 8/2010 Nagayama D14/223
- D622,265 S * 8/2010 Rye D14/223
- D622,705 S * 8/2010 Fahrendorff D14/223
- D623,171 S * 9/2010 Chen D14/223

(Continued)

Primary Examiner — Paula Greene
(74) *Attorney, Agent, or Firm* — NSIP Law

(57) **CLAIM**
We claim the ornamental design for a cap for headset, as shown and described.

DESCRIPTION

FIG. 1 is a front perspective view of a cap for headset showing our new design;
 FIG. 2 is a front view thereof;
 FIG. 3 is a rear view thereof;
 FIG. 4 is a left-side view thereof;
 FIG. 5 is a right-side view thereof;
 FIG. 6 is a top view thereof;
 FIG. 7 is a bottom view thereof;
 FIG. 8 is a cross sectional view taken along the line 8-8 of FIG. 6;
 FIG. 9 is an another perspective view thereof, as shown a headset environment; and,
 FIG. 10 is an enlarged exploded view of a portion of the cap for headset of FIG. 9.
 The broken lines in the figures show portions of the cap for headset which form no part of the claimed design.
 The dot-dash broken lines encircling enlargement portions of the design forms no part of the claimed design.

1 Claim, 10 Drawing Sheets

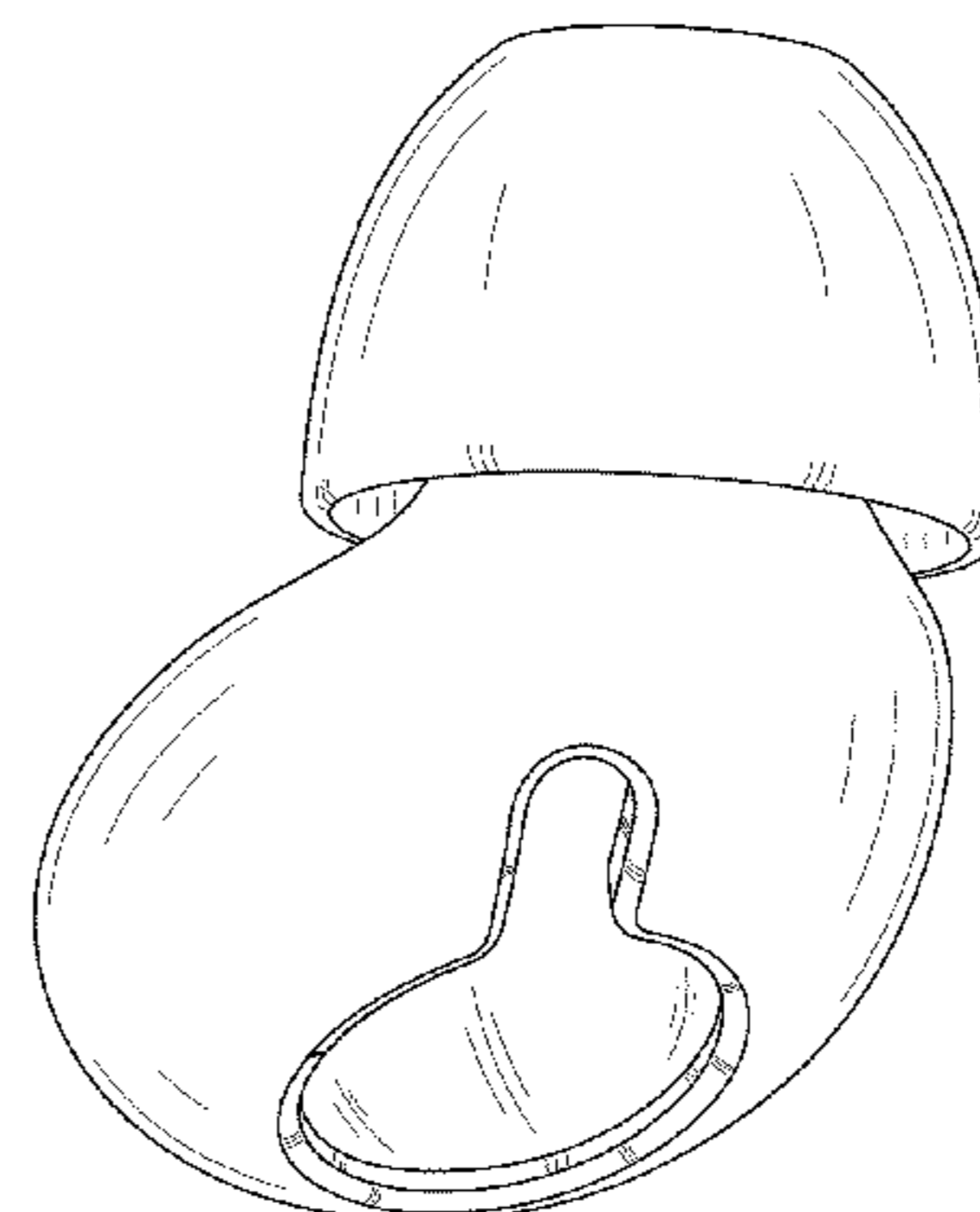
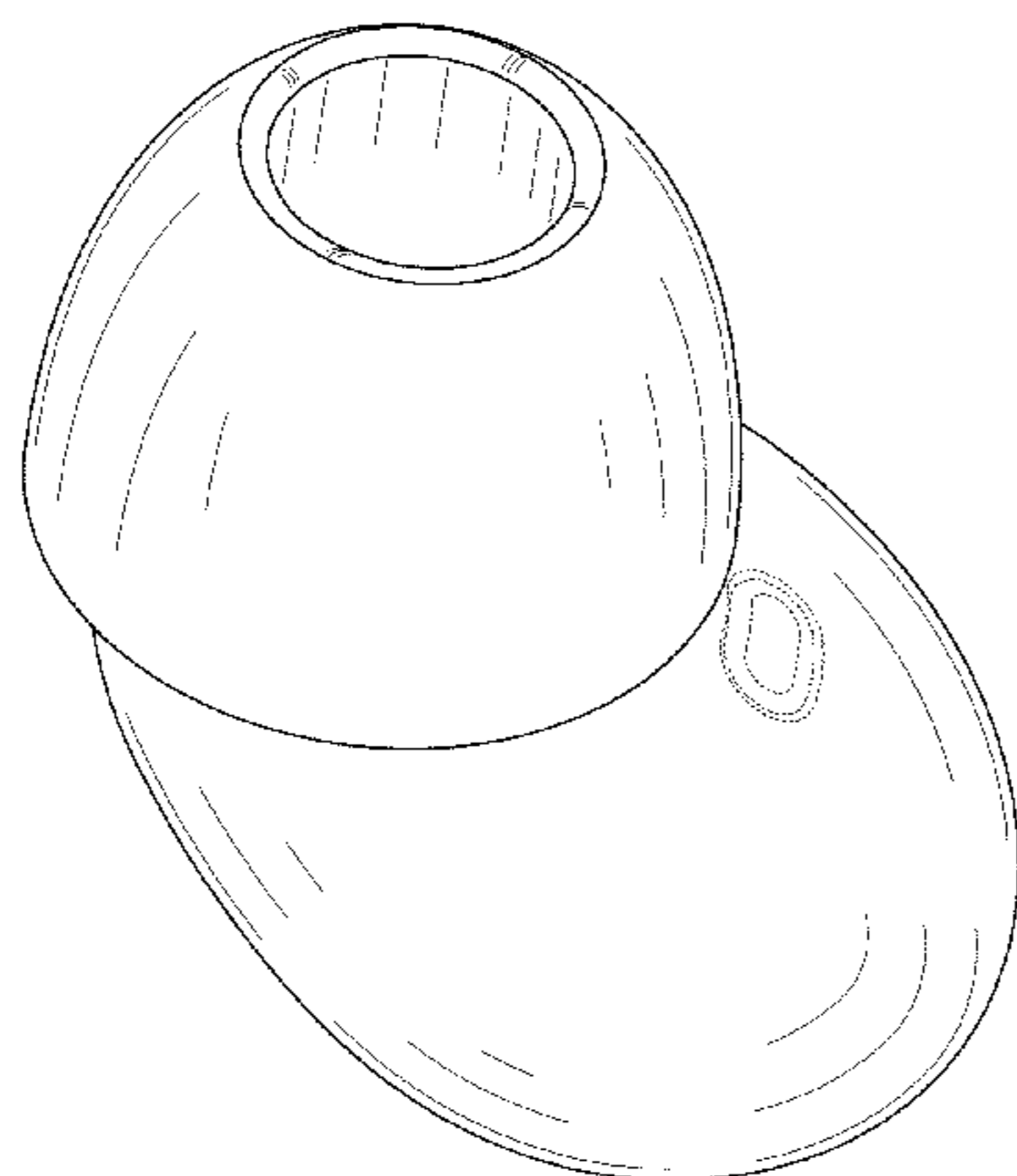

(56)

References Cited

U.S. PATENT DOCUMENTS

D627,766 S * 11/2010 Arimoto D14/223
7,965,855 B1 * 6/2011 Ham H04R 1/1091
181/130
D660,291 S * 5/2012 Thomas D14/223

8,666,102 B2 * 3/2014 Bruckhoff A61F 11/008
381/328
D712,882 S * 9/2014 Wang D14/223
D716,770 S * 11/2014 Bonahoom D14/223
D732,008 S * 6/2015 Akana D14/223
D742,362 S * 11/2015 Bonahoom D14/205
D744,456 S * 12/2015 Pedersen D14/223

* cited by examiner

FIG. 1

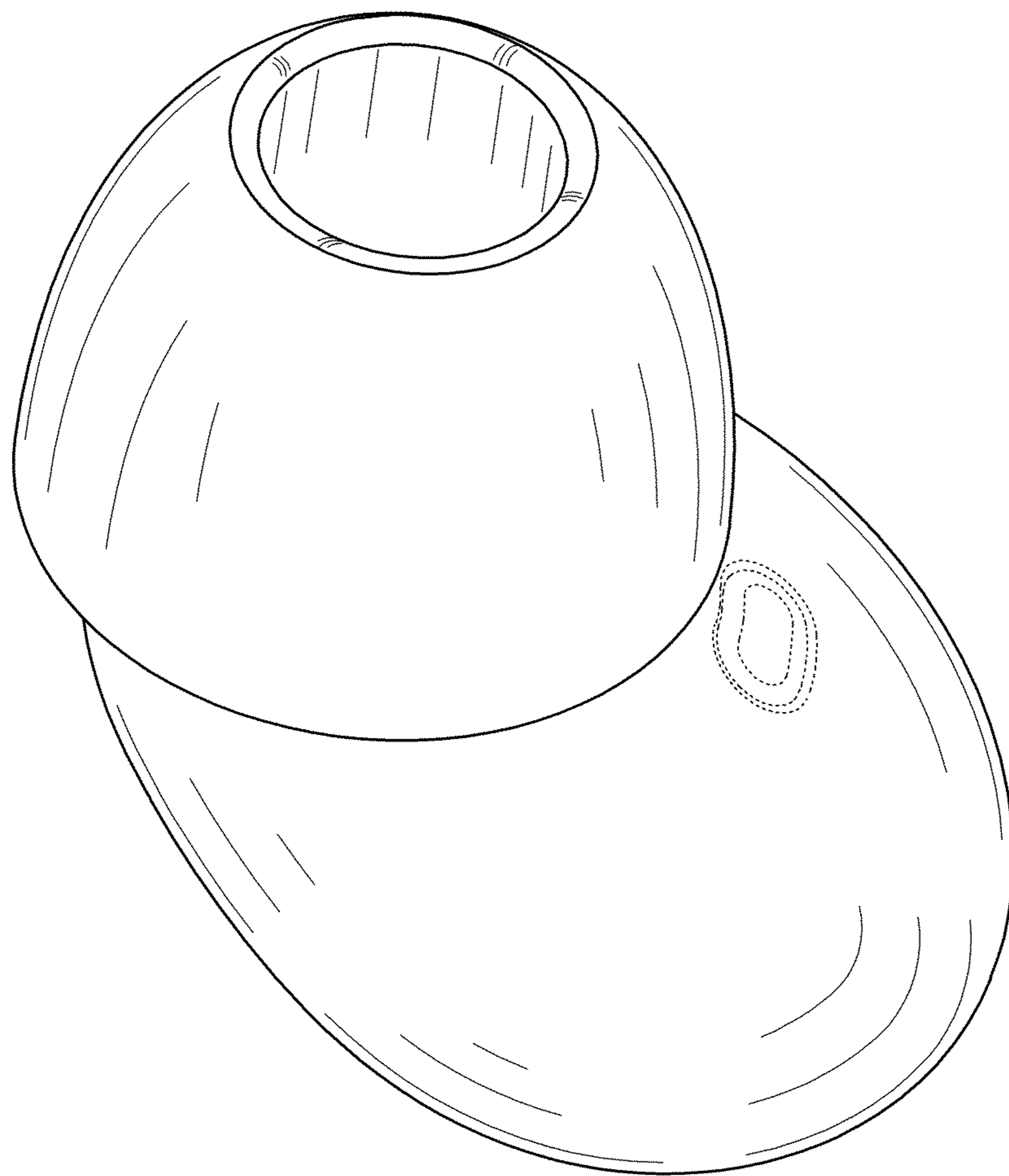

FIG. 2

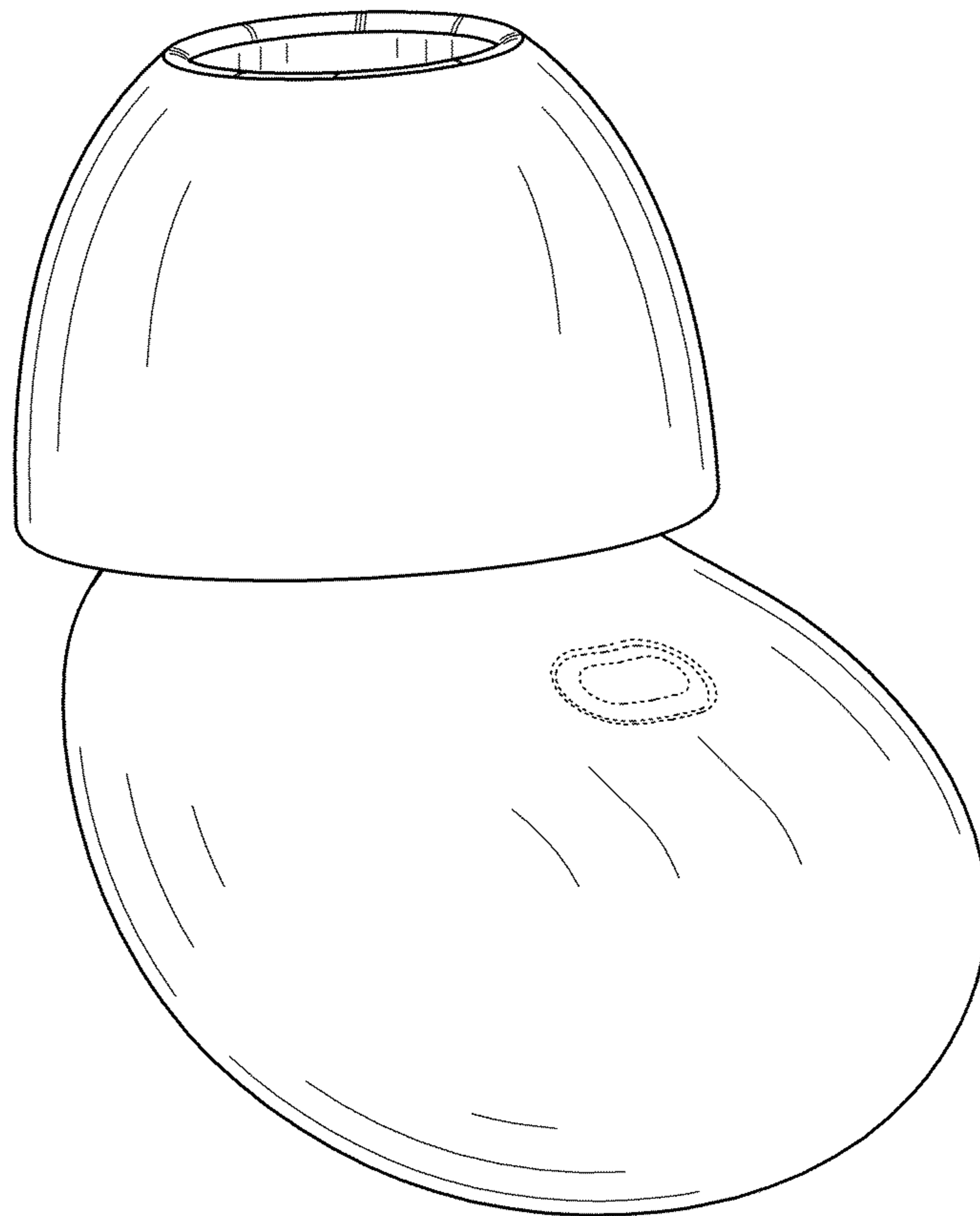

FIG. 3



FIG. 4



FIG. 5

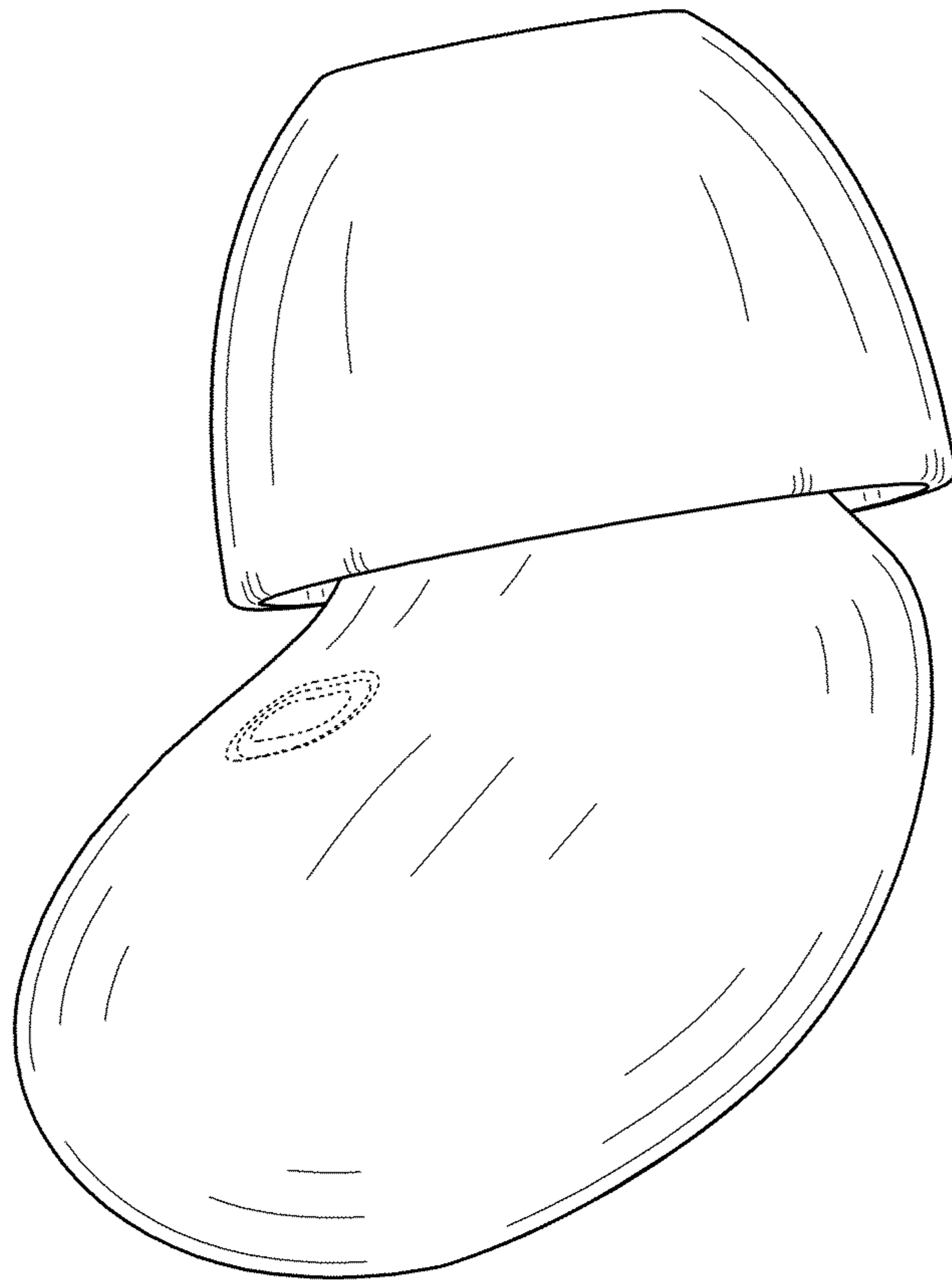

FIG. 6

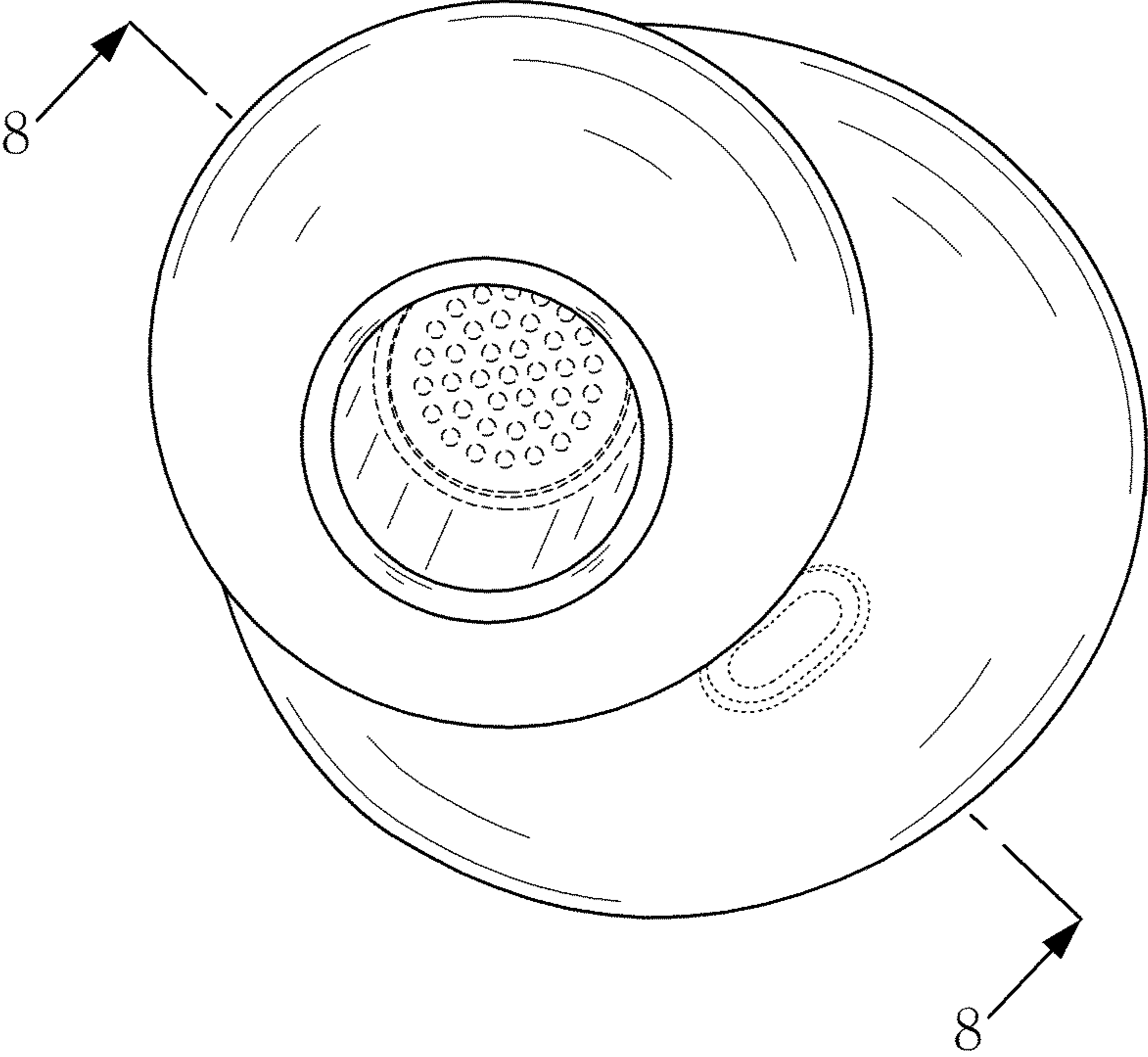

FIG. 7

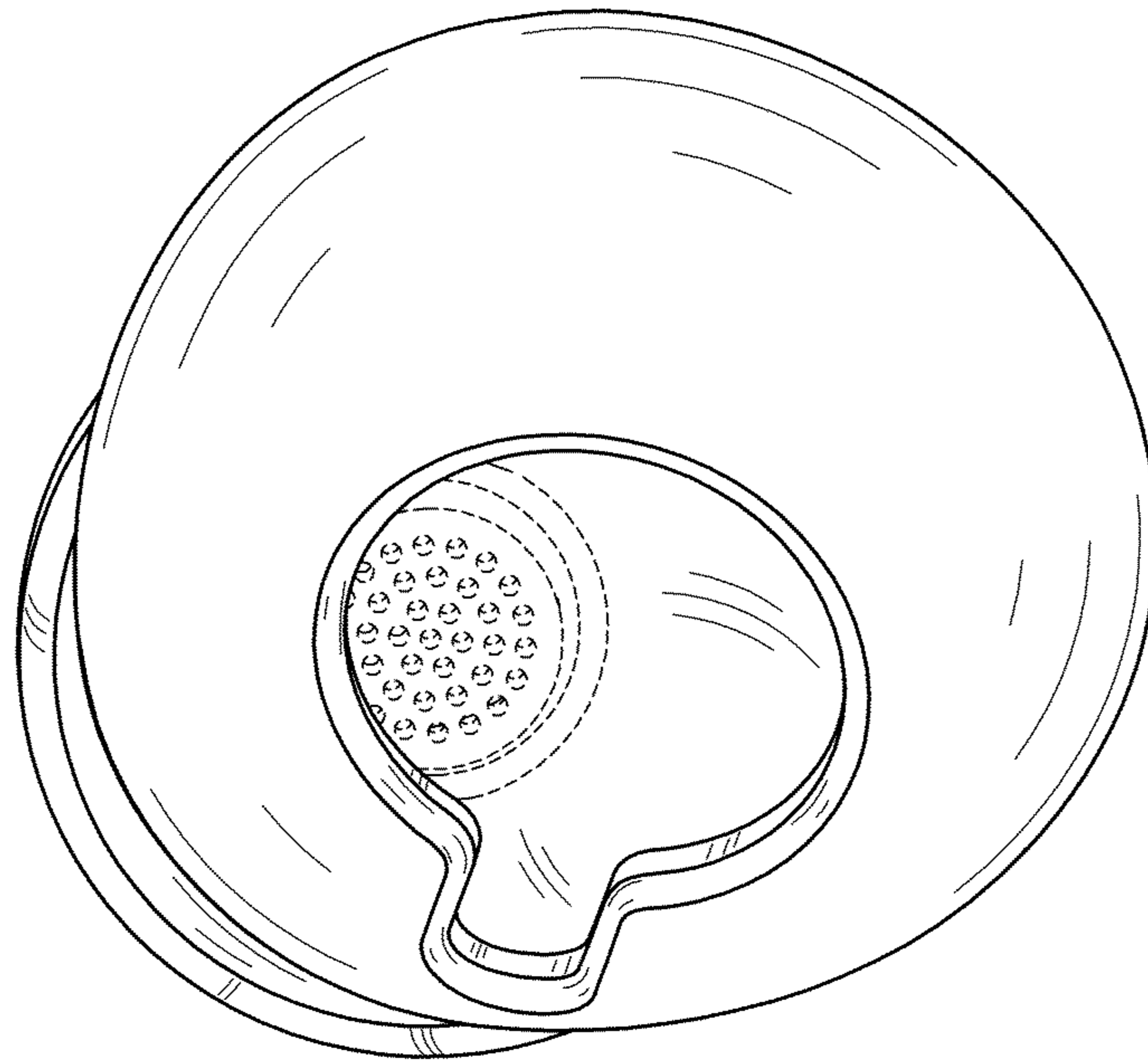

FIG. 8

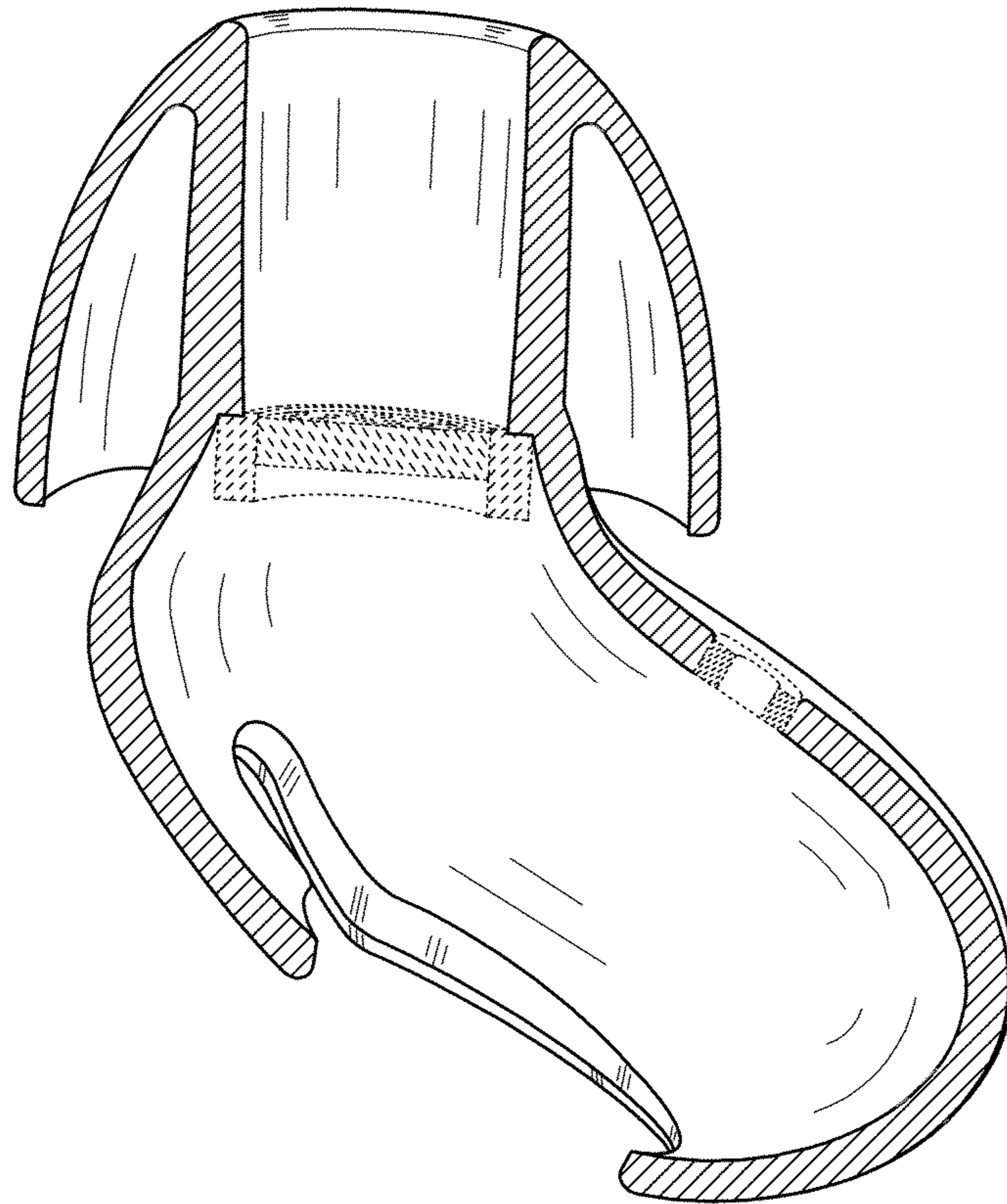

FIG. 9

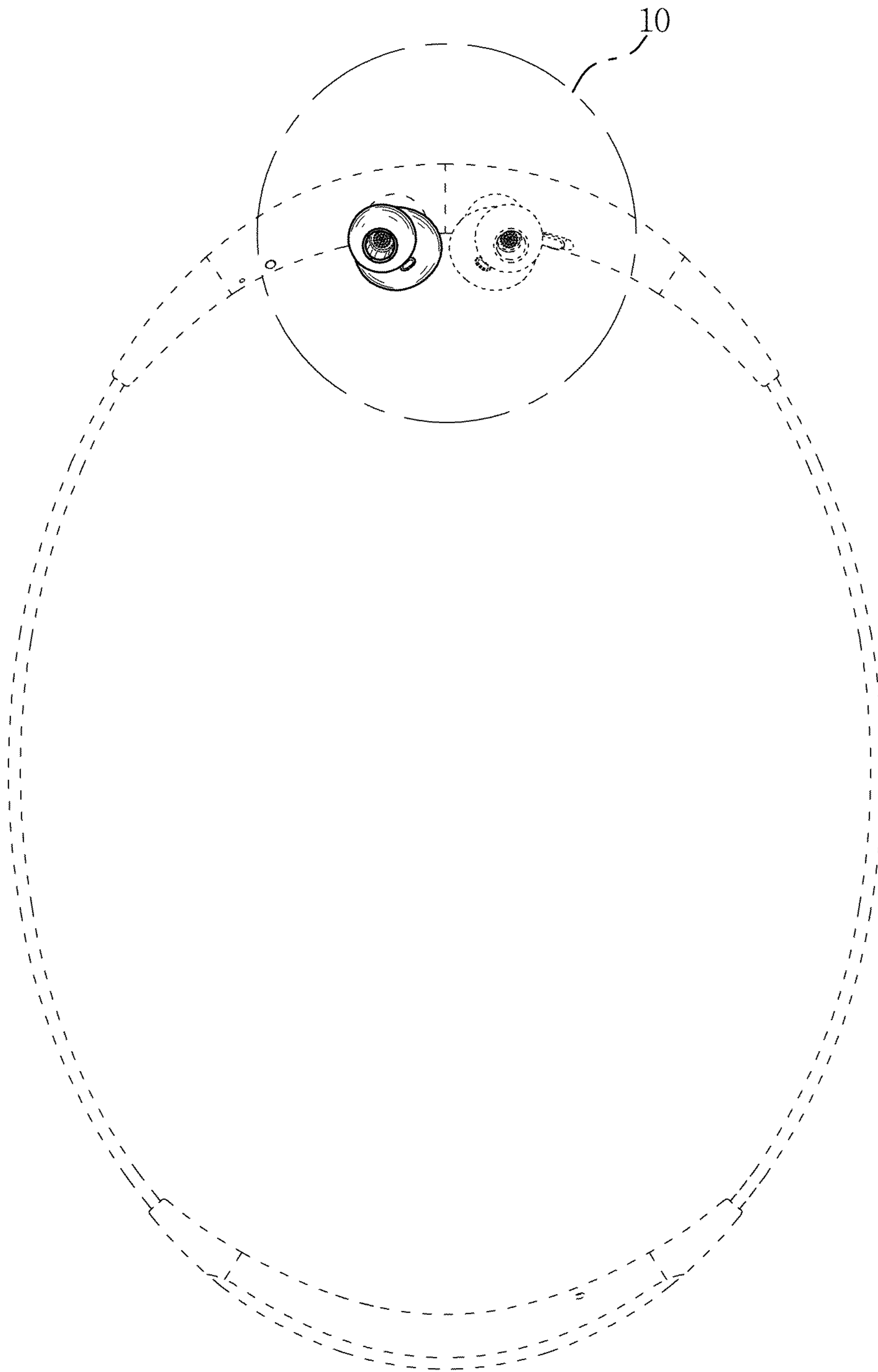

FIG. 10

