



US00D755128S

(12) **United States Design Patent**  
**Page et al.**

(10) **Patent No.:** **US D755,128 S**  
(45) **Date of Patent:** **\*\* May 3, 2016**

- (54) **DESKTOP RECEPTACLE**
- (71) Applicant: **Group Dekko, Inc.**, Garrett, IN (US)
- (72) Inventors: **Richard J. Page**, Lake Villa, IL (US);  
**Brian Rupert**, Kendallville, IN (US)
- (73) Assignee: **Group Dekko, Inc.**, Garrett, IN (US)
- (\*\*) Term: **14 Years**
- (21) Appl. No.: **29/497,325**
- (22) Filed: **Jul. 23, 2014**
- (51) **LOC (10) Cl.** ..... **13-03**
- (52) **U.S. Cl.**  
USPC ..... **D13/139.4**
- (58) **Field of Classification Search**  
USPC ..... D13/139.4, 139.5, 156, 160,  
D13/137.1–137.3, 139.6–139.8, 152, 139.1;  
361/753, 601; 174/56  
CPC ..... H05K 9/0039; H01R 13/70; H02G 3/18  
See application file for complete search history.

(56) **References Cited**

**U.S. PATENT DOCUMENTS**

D361,315 S *	8/1995	Wedell et al.	.....	D13/160
5,566,053 A *	10/1996	Chou	.....	361/753
D401,555 S *	11/1998	Tam	.....	D13/137.3
D469,063 S *	1/2003	Nieto et al.	.....	D13/137.2
D514,067 S *	1/2006	Lee	.....	D13/137.2
D581,874 S *	12/2008	Zhou	.....	D13/139.6
7,663,866 B2 *	2/2010	Lee et al.	.....	361/601
D626,071 S *	10/2010	Su et al.	.....	D13/139.8
D674,349 S *	1/2013	Lee et al.	.....	D13/139.8

D679,256 S *	4/2013	Ericksen et al.	.....	D13/156
D695,693 S *	12/2013	Lee et al.	.....	D13/152
D703,139 S *	4/2014	Dodal et al.	.....	D13/139.1
D712,838 S *	9/2014	Beldock et al.	.....	D13/139.5
D715,225 S *	10/2014	Mininger et al.	.....	D13/139.4
D721,043 S *	1/2015	Tonnesen	.....	D13/156
D721,653 S *	1/2015	Lee et al.	.....	D13/139.3
2009/0294147 A1 *	12/2009	Stockton	.....	174/56

\* cited by examiner

*Primary Examiner* — Holly Baynham

*Assistant Examiner* — Rhea Shields

(74) *Attorney, Agent, or Firm* — Taylor IP, P.C.

(57) **CLAIM**

The ornamental design for a desktop receptacle, as shown and described.

**DESCRIPTION**

FIG. 1 is a front perspective view of a desktop receptacle showing our new design;  
 FIG. 2 is a rear perspective view thereof;  
 FIG. 3 is a top view thereof, additionally the bottom view is omitted because this view is identical to FIG. 3;  
 FIG. 4 is a front view thereof;  
 FIG. 5 is a side view thereof, additionally the opposite side view is omitted because this view is a mirror image of FIG. 5;  
 and,  
 FIG. 6 is a rear view thereof.

In the drawings, the broken lines are for the purpose of illustrating environment only and form no part of the claimed design.

**1 Claim, 3 Drawing Sheets**

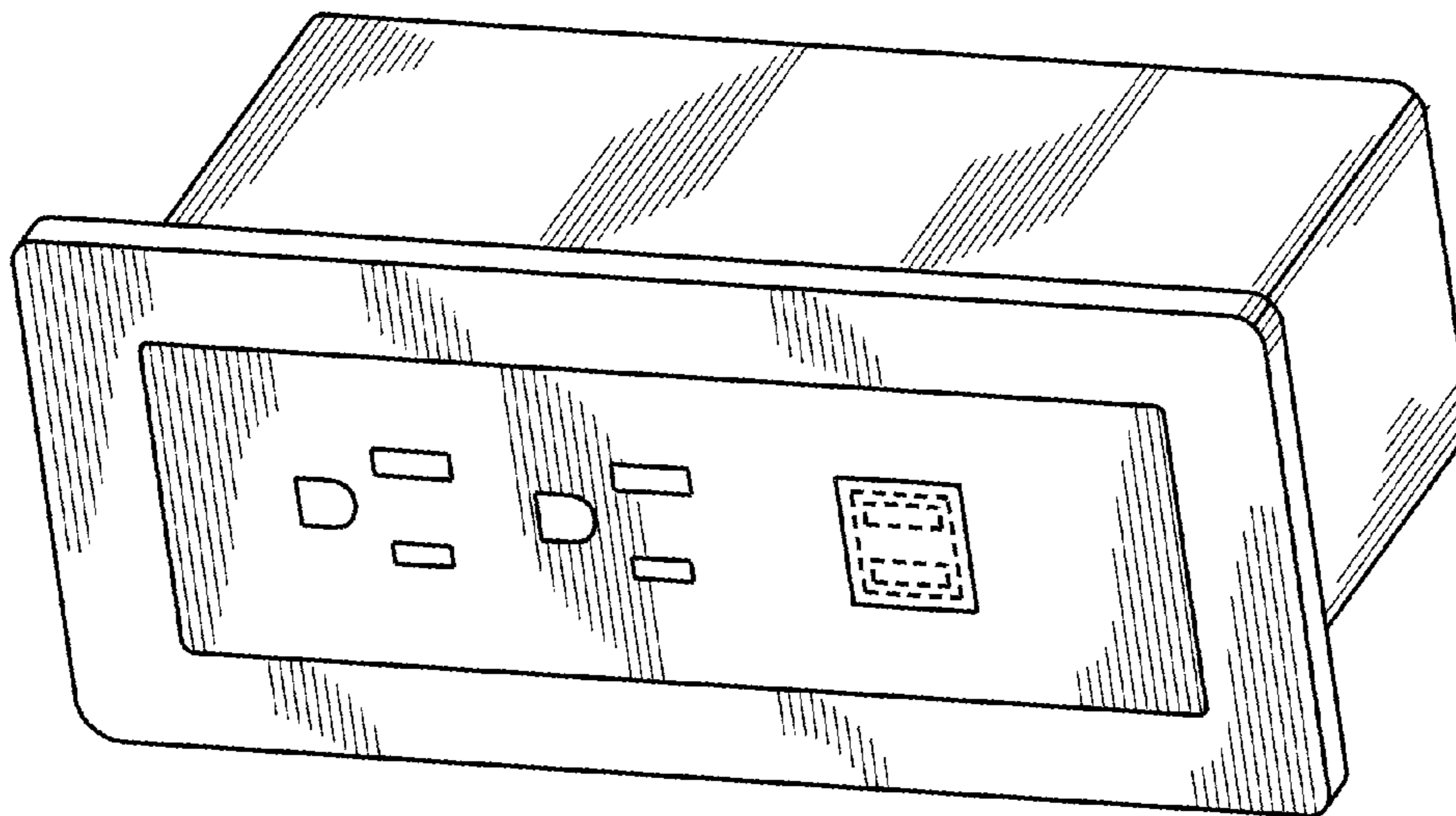

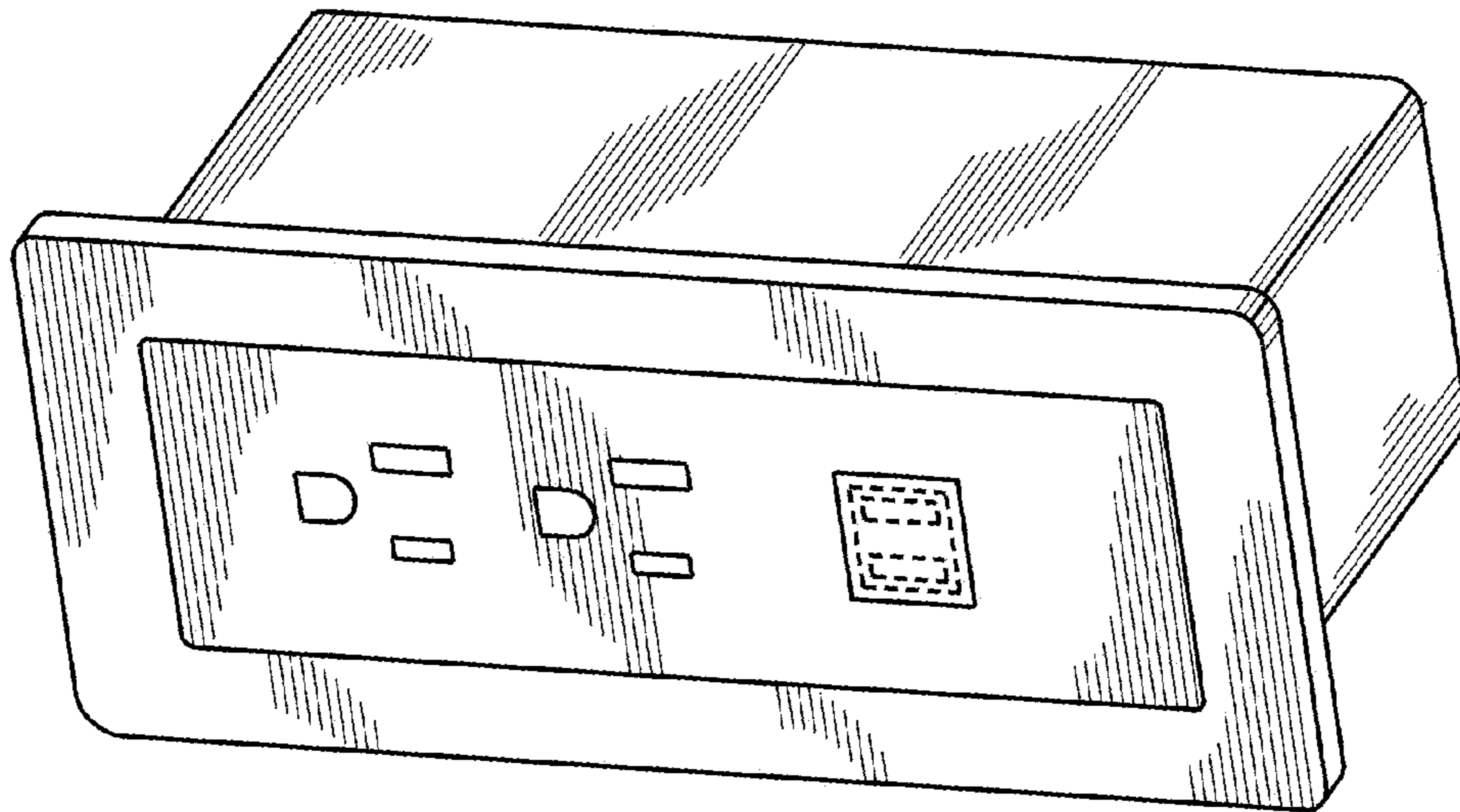

Fig. 1

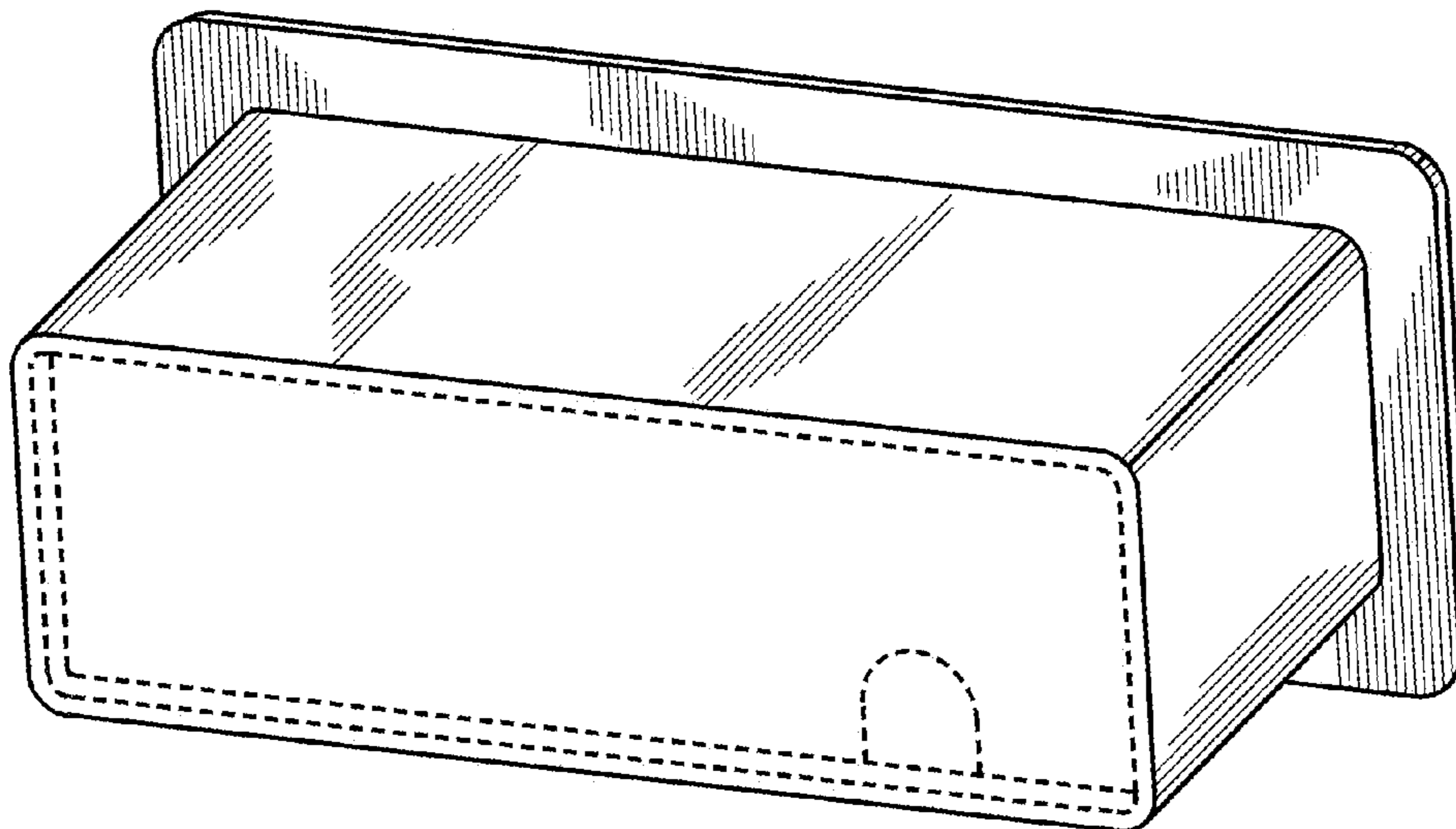

Fig. 2

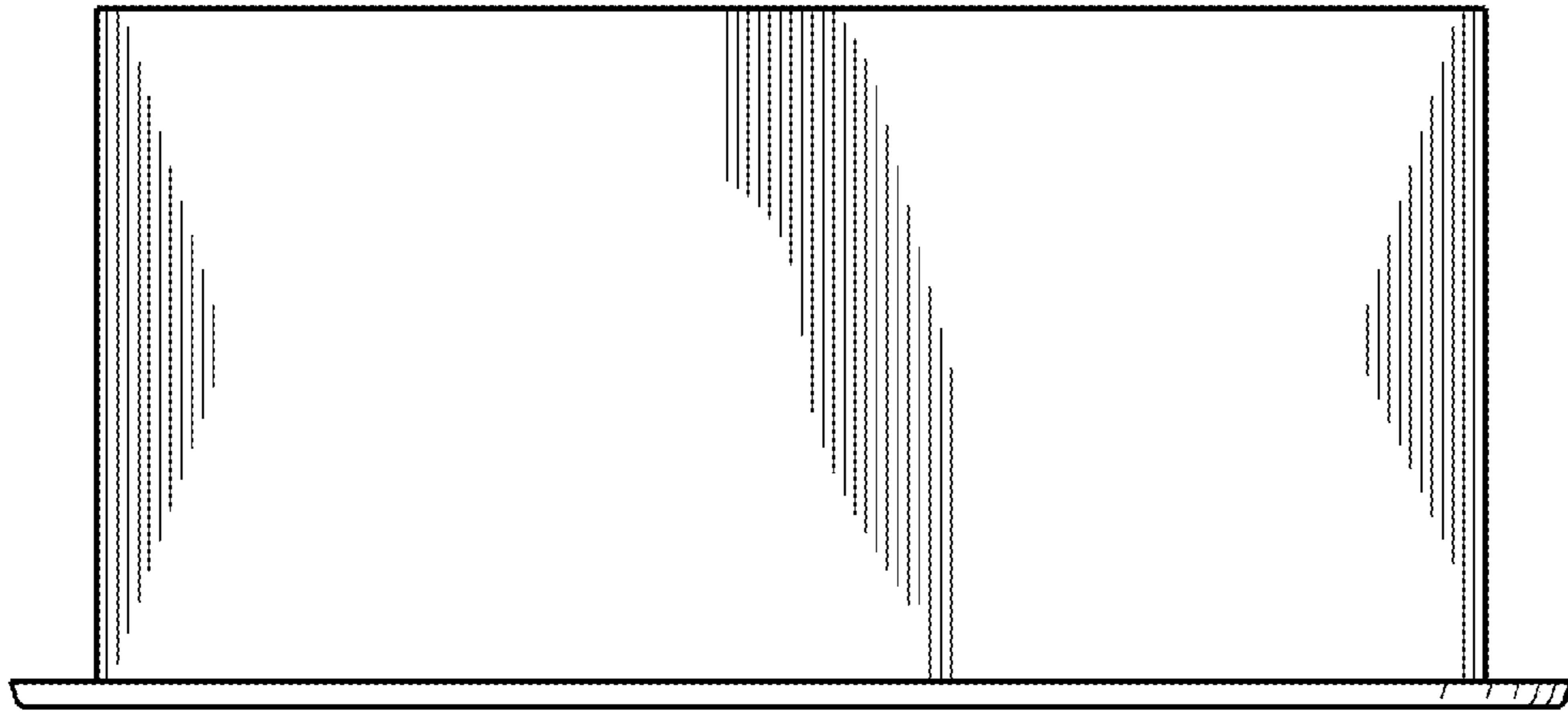

Fig. 3

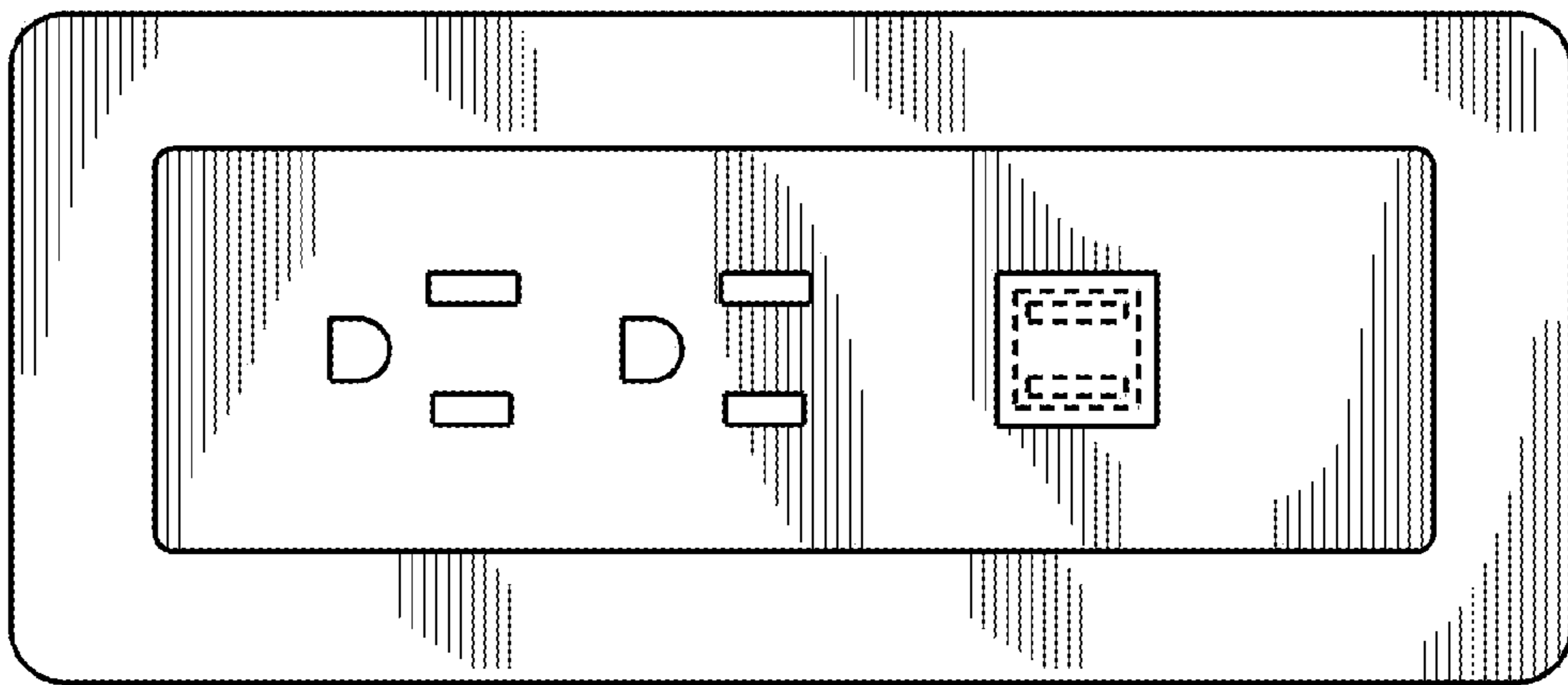

Fig. 4

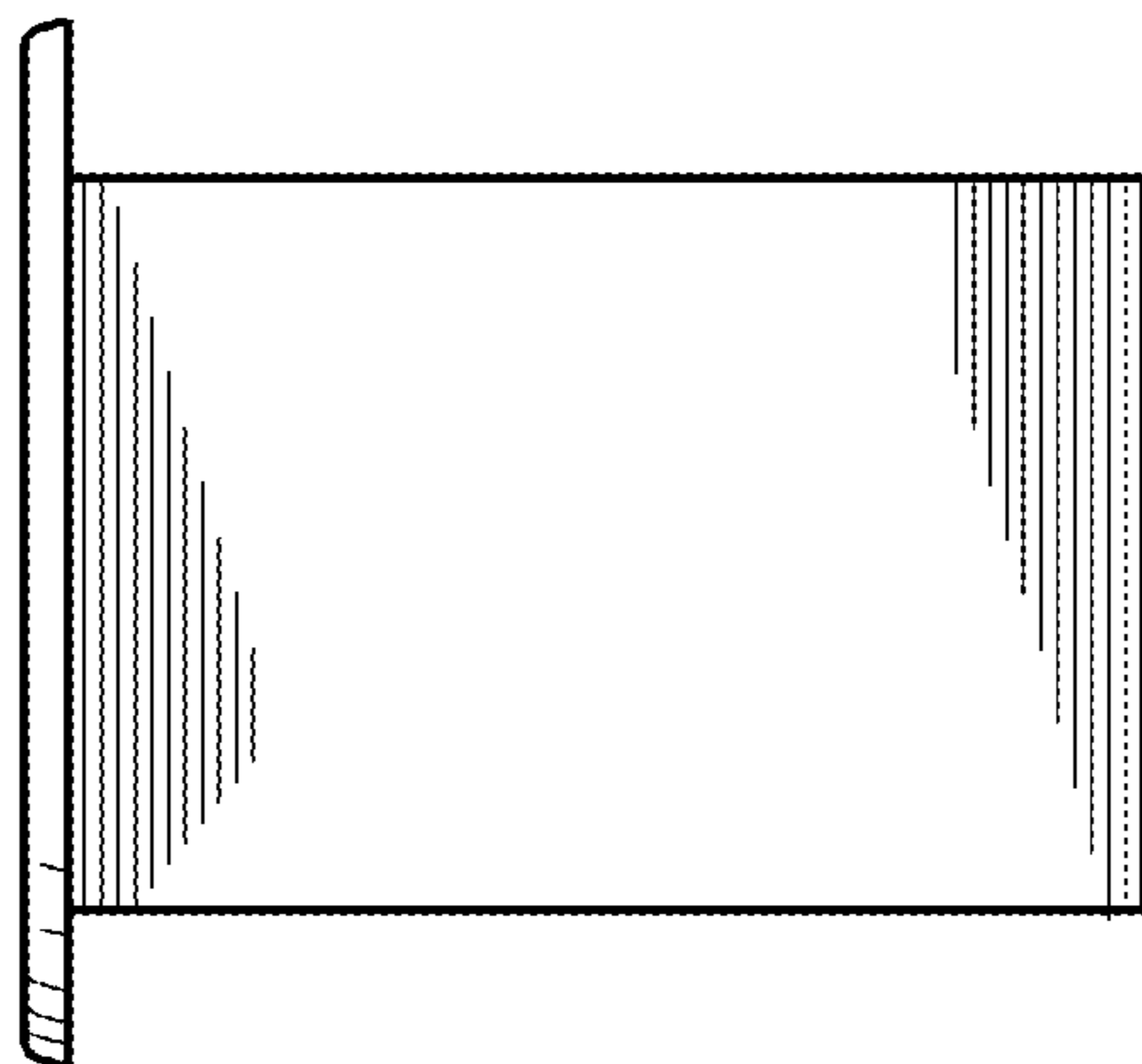

Fig. 5

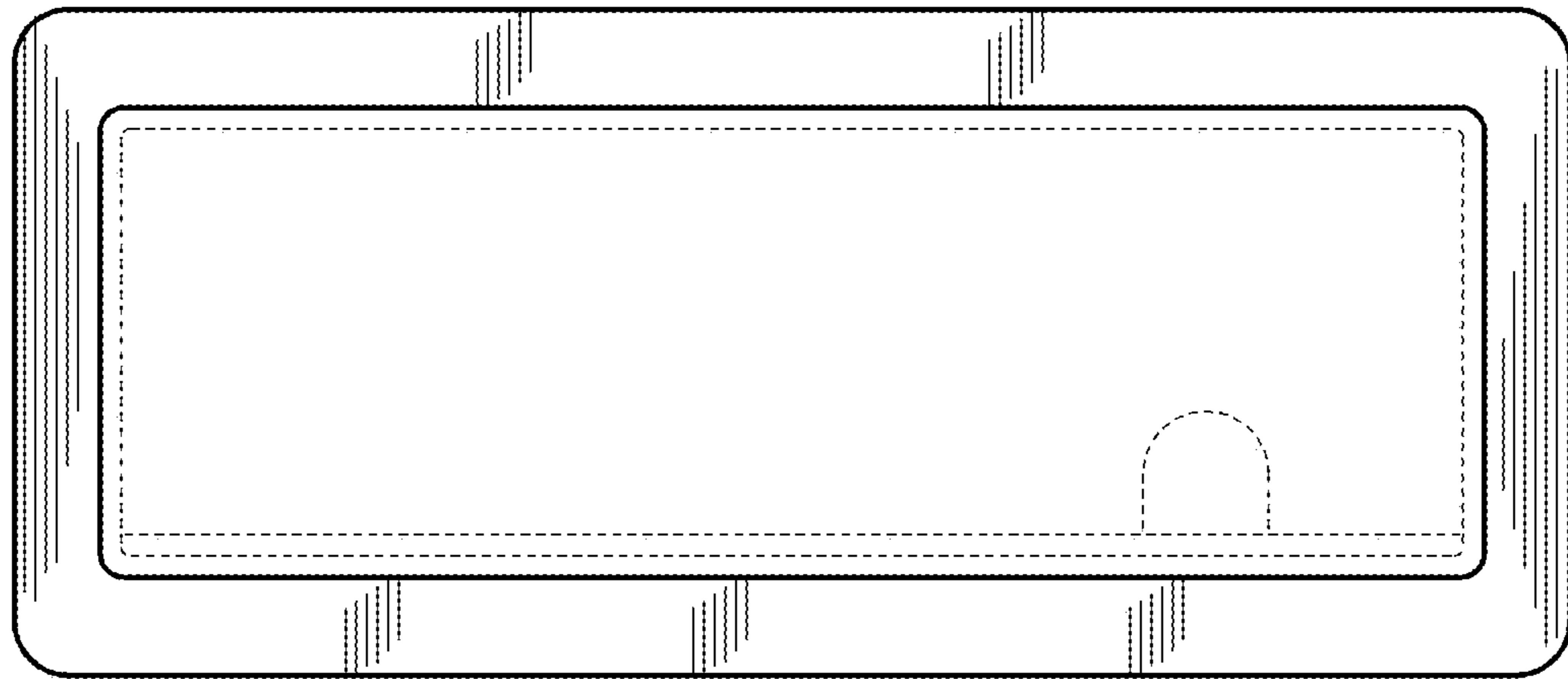

Fig. 6