



US00D755080S

(12) **United States Design Patent**  
**Vardis et al.**

(10) **Patent No.:** **US D755,080 S**  
(45) **Date of Patent:** **\*\* May 3, 2016**

(54) **AUTOMOBILE EXTERIOR**

(71) Applicants: **Nicholas Vardis**, Sylvan Lake, MI (US);  
**Khashayar Honarkhah**, Bloomfield Hills, MI (US); **Mark C Trostle**, Rochester, MI (US)

(72) Inventors: **Nicholas Vardis**, Sylvan Lake, MI (US);  
**Khashayar Honarkhah**, Bloomfield Hills, MI (US); **Mark C Trostle**, Rochester, MI (US)

(73) Assignee: **FCA US LLC**, Auburn Hills, MI (US)

(\*\*) Term: **14 Years**

(21) Appl. No.: **29/510,556**

(22) Filed: **Dec. 1, 2014**

(51) **LOC (10) Cl.** ..... **12-08**

(52) **U.S. Cl.**  
USPC ..... **D12/92**

(58) **Field of Classification Search**  
USPC ..... D12/86, 90-92; D21/421, 433, 434;  
296/181.1, 181.5  
CPC ..... B62D 35/00; B62D 25/00; B62D 25/06;  
B62D 33/00

See application file for complete search history.

(56) **References Cited**

U.S. PATENT DOCUMENTS

D539,191 S	3/2007	Castiglione et al.	
D552,514 S	10/2007	Catiglioione et al.	
D620,398 S *	7/2010	Abdallah	D12/92
D658,546 S *	5/2012	Abdallah	D12/92
D658,547 S *	5/2012	Abdallah	D12/92

\* cited by examiner

*Primary Examiner* — Melody N Brown

(74) *Attorney, Agent, or Firm* — Ralph E. Smith

(57) **CLAIM**

The ornamental design for an automobile exterior, as shown and described.

**DESCRIPTION**

FIG. 1 is a front perspective view of an automobile exterior showing our new design;  
FIG. 2 is a rear perspective view thereof;  
FIG. 3 is a top plan view thereof;  
FIG. 4 is a left side view thereof;  
FIG. 5 is a right side view thereof;  
FIG. 6 is a front view thereof; and,  
FIG. 7 is a rear view thereof.  
It will be understood that the broken lines shown in the drawings illustrate portions of the automobile exterior that form no part of claimed design.

**1 Claim, 6 Drawing Sheets**

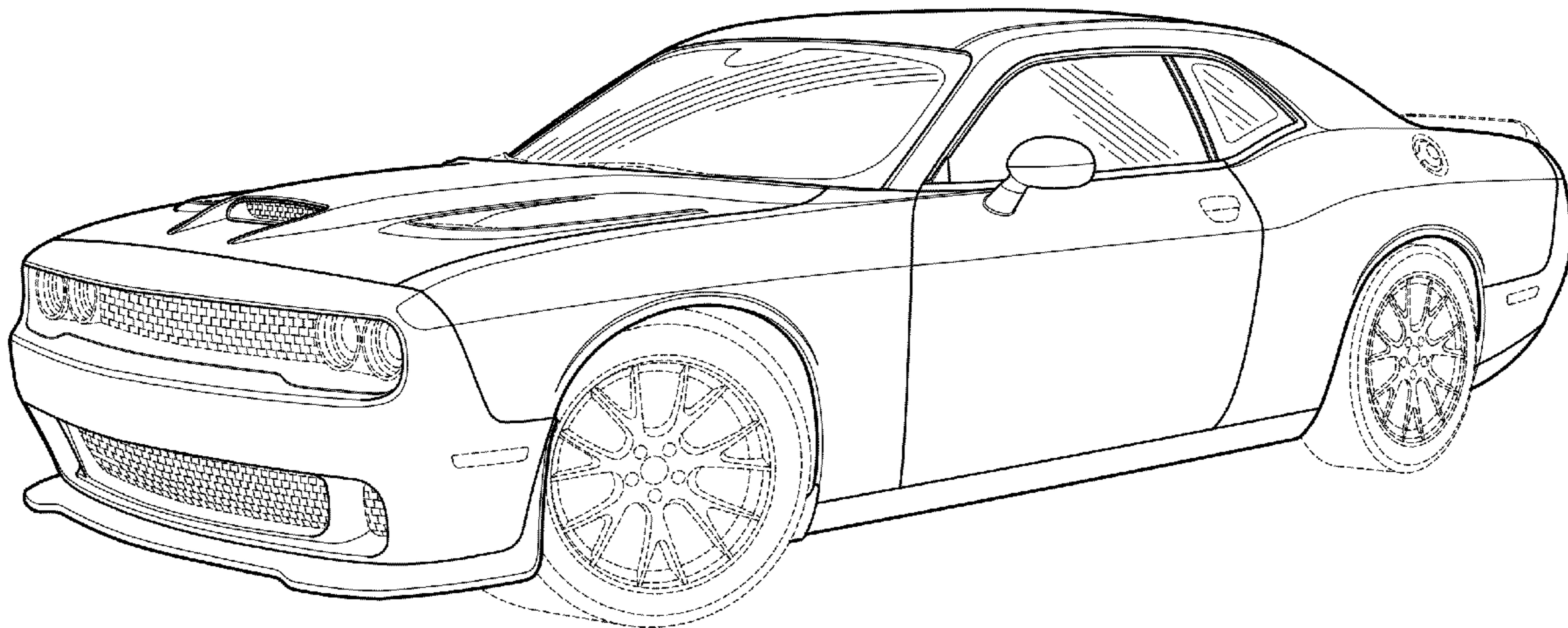

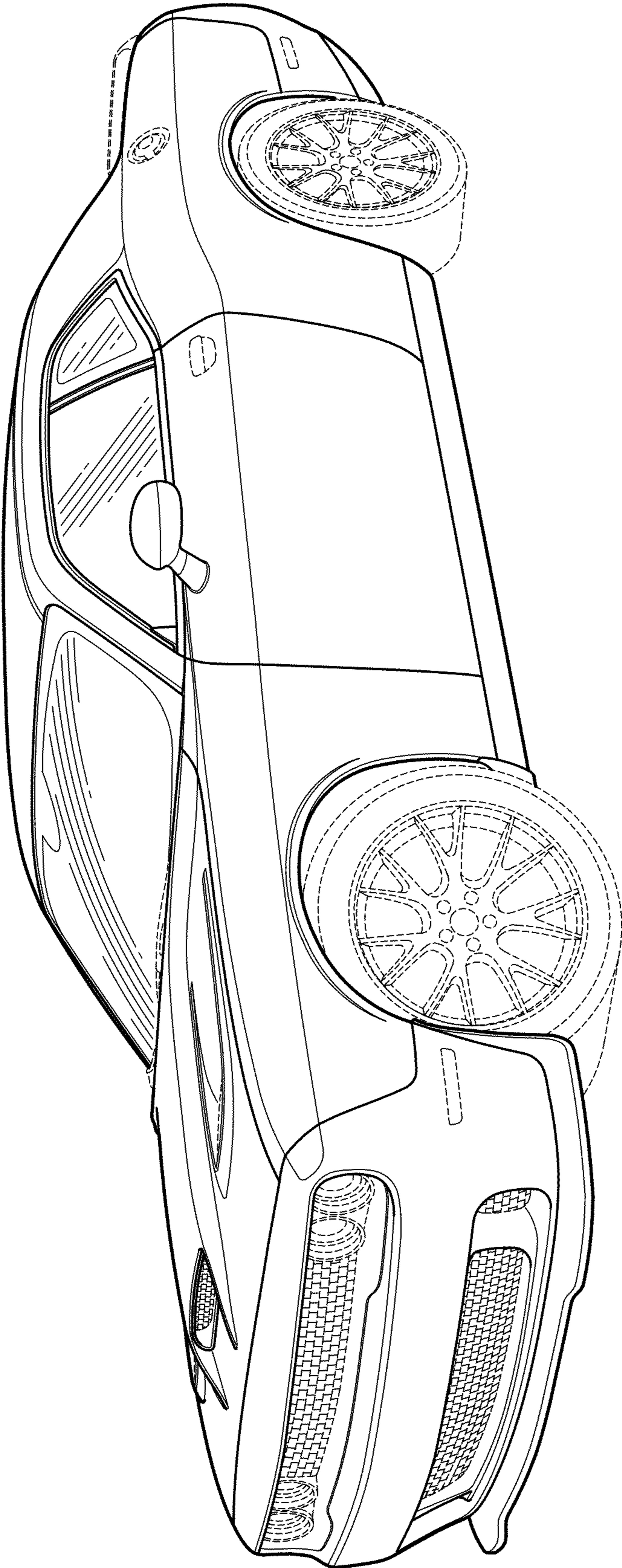

FIG. 1

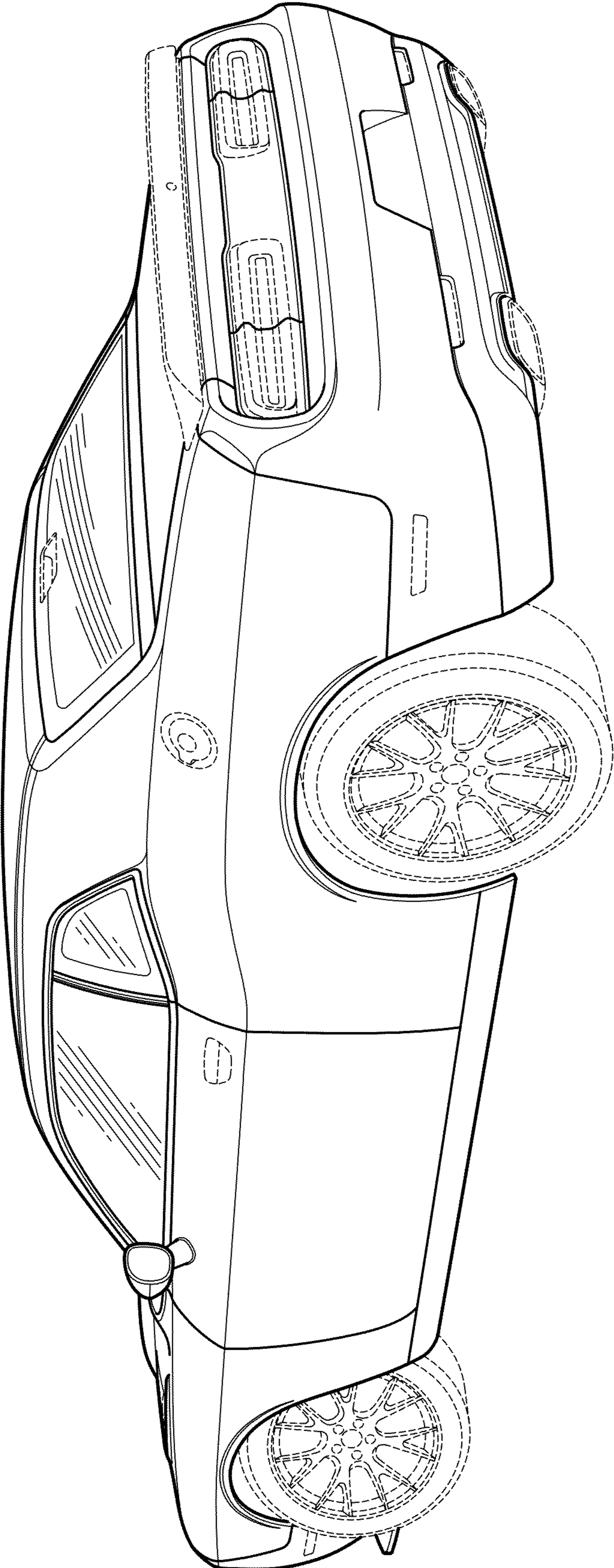

FIG. 2

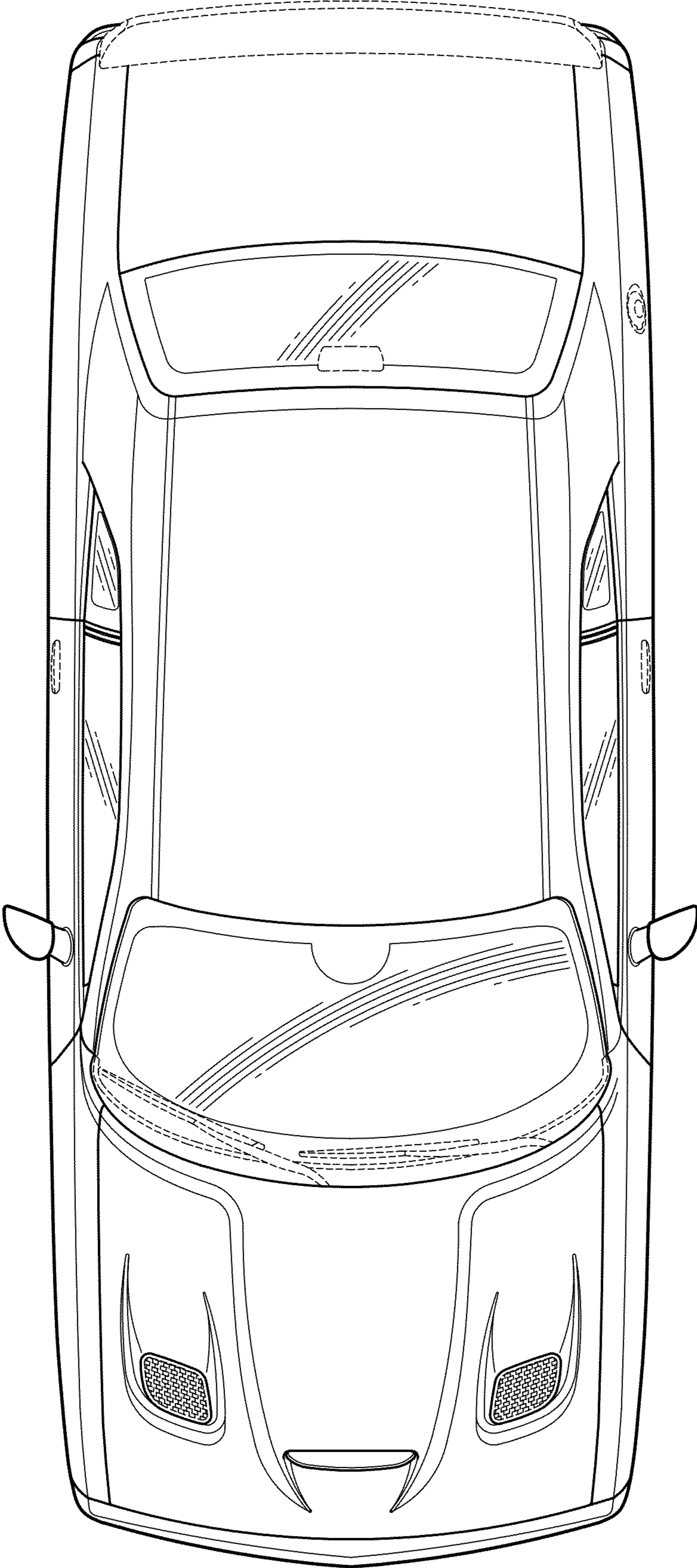

FIG. 3

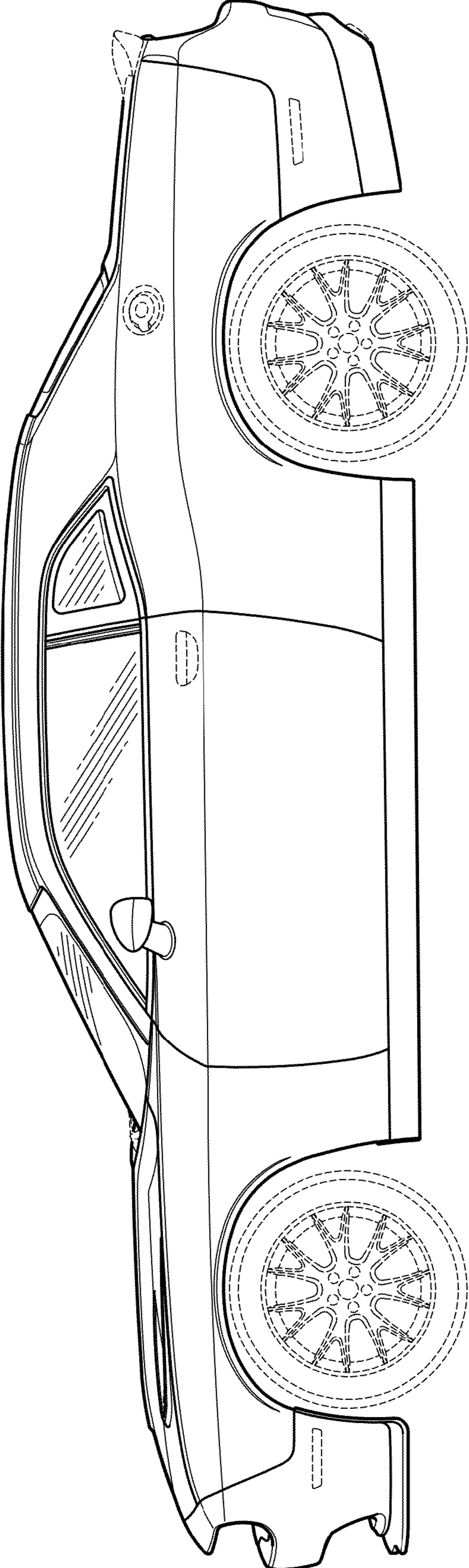

FIG. 4

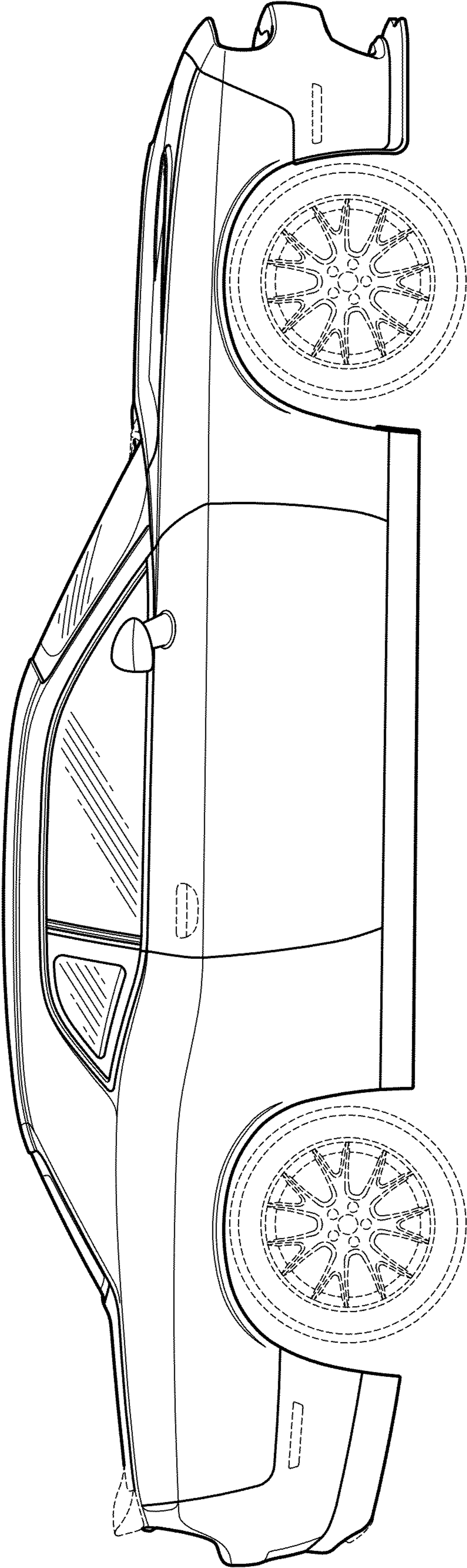

FIG. 5

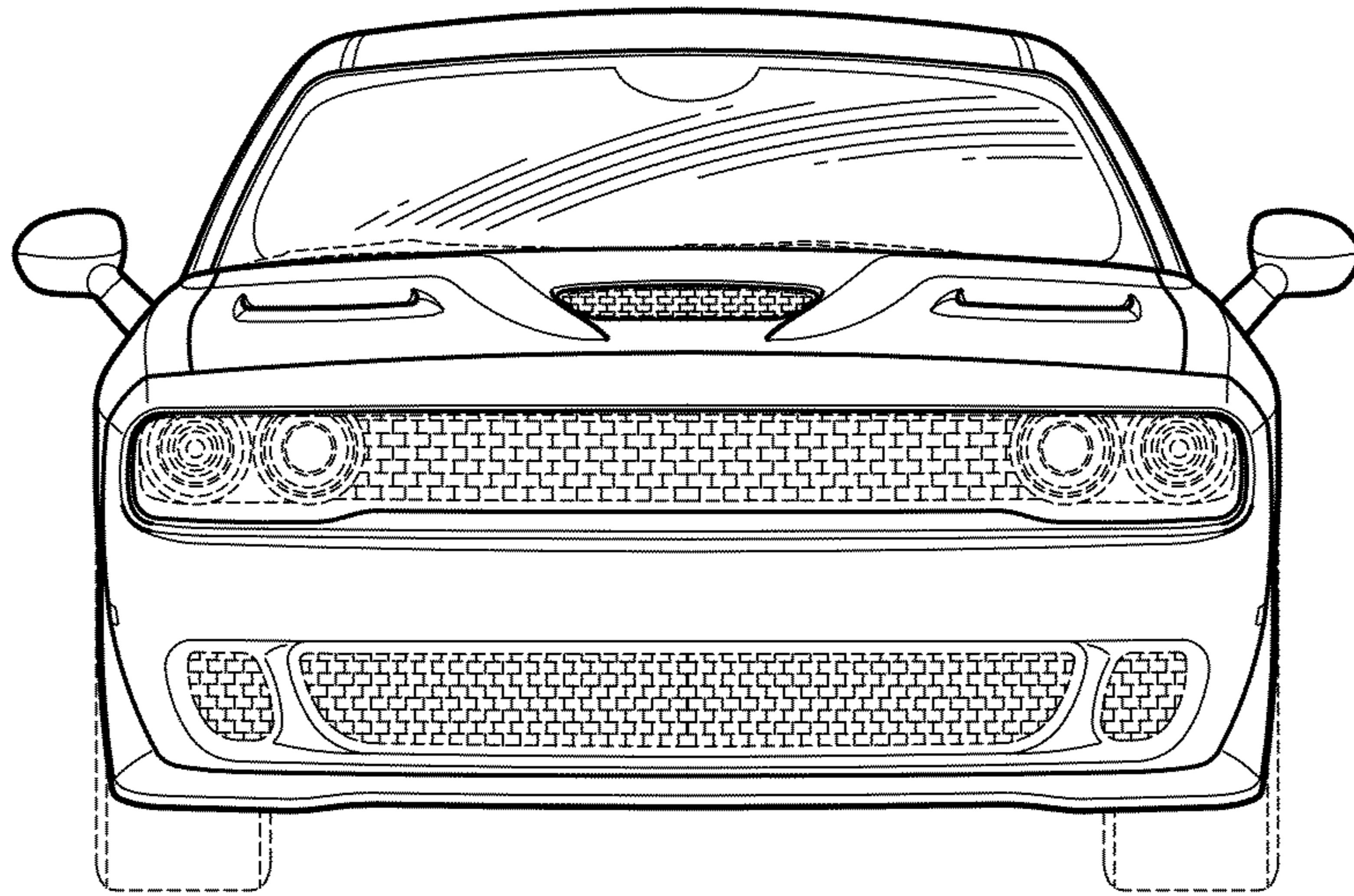

FIG. 6

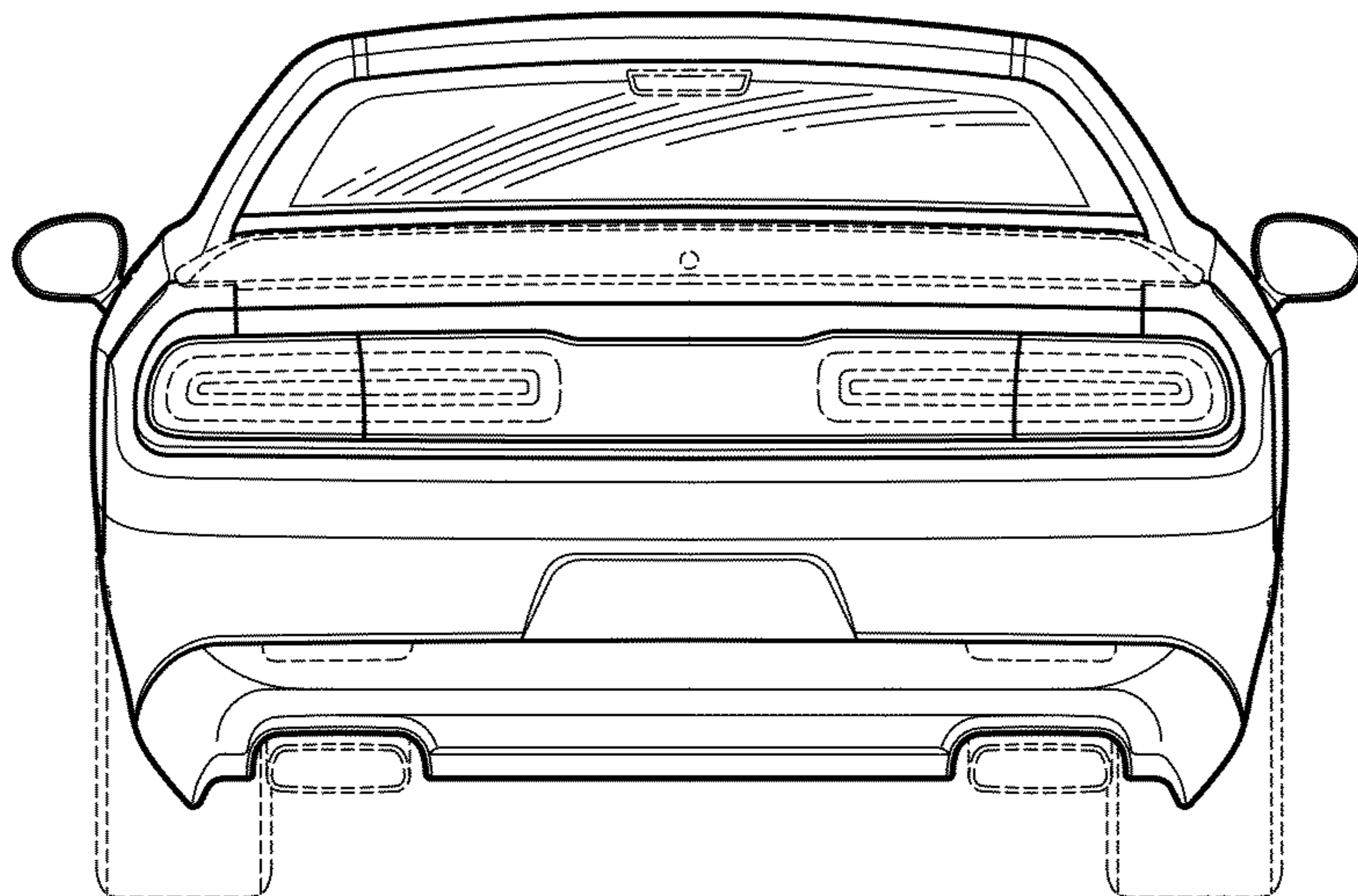

FIG. 7