



US00D755067S

(12) **United States Design Patent**
Berme et al.

(10) **Patent No.:** **US D755,067 S**
(45) **Date of Patent:** **** May 3, 2016**

(54) **VISUAL DISPLAY DEVICE FOR A FORCE AND/OR MOTION MEASUREMENT SYSTEM**

(71) Applicant: **Bertec Corporation**, Columbus, OH (US)

(72) Inventors: **Necip Berme**, Worthington, OH (US); **Scott Zerkle Barnes**, Thornville, OH (US); **Benjamin Robert Hoffman**, Columbus, OH (US); **Sasan Ghassab**, Columbus, OH (US)

(73) Assignee: **Bertec Corporation**, Columbus, OH (US)

(**) Term: **15 Years**

(21) Appl. No.: **29/543,070**

(22) Filed: **Oct. 20, 2015**

(51) **LOC (10) Cl.** **10-04**

(52) **U.S. Cl.**
USPC **D10/103**

(58) **Field of Classification Search**

USPC D10/83, 94, 103

CPC G06F 3/0346; G06F 3/147; G06F 3/0482;

G01L 5/16; G01L 5/161; G01L 1/2206;

G09G 5/12; G09G 2380/08; A61B 5/1036;

A61B 5/742; A61B 5/7275; A61B 5/4064;

A61B 5/4023; G01G 19/44; G01M 1/122

See application file for complete search history.

(56) **References Cited**

U.S. PATENT DOCUMENTS

D311,383 S * 10/1990 Falck D10/103

(Continued)

Primary Examiner — Antoine D Davis

(74) *Attorney, Agent, or Firm* — The Law Office of Patrick F. O'Reilly, III, LLC

(57) **CLAIM**

The ornamental design for a visual display device for a force and/or motion measurement system, as shown and described.

DESCRIPTION

FIG. 1 is a front-right perspective view of a first embodiment of a visual display device for a force and/or motion measurement system showing our new design;

FIG. 2 is a front elevational view of the embodiment shown in FIG. 1;

FIG. 3 is a top plan view of the embodiment shown in FIG. 1;

FIG. 4 is a bottom plan view of the embodiment shown in FIG. 1;

FIG. 5 is a right side elevational view of the embodiment shown in FIG. 1;

FIG. 6 is a left side elevational view of the embodiment shown in FIG. 1;

FIG. 7 is a rear elevational view of the embodiment shown in FIG. 1;

FIG. 8 is a rear-right perspective view of the embodiment shown in FIG. 1;

FIG. 9 is a rear-left perspective view of the embodiment shown in FIG. 1;

FIG. 10 is a front-right perspective view of a second embodiment of a visual display device for a force and/or motion measurement system showing our new design;

FIG. 11 is a front elevational view of the embodiment shown in FIG. 10;

FIG. 12 is a top plan view of the embodiment shown in FIG. 10;

FIG. 13 is a bottom plan view of the embodiment shown in FIG. 10;

FIG. 14 is a right side elevational view of the embodiment shown in FIG. 10;

FIG. 15 is a left side elevational view of the embodiment shown in FIG. 10;

FIG. 16 is a rear elevational view of the embodiment shown in FIG. 10;

FIG. 17 is a rear-right perspective view of the embodiment shown in FIG. 10; and,

FIG. 18 is a rear-left perspective view of the embodiment shown in FIG. 10.

The broken line portions of the drawing figures are included to show unclaimed subject matter only and form no part of the claimed design. As shown in the drawing figures, the seams between the sections of the visual display device, the flanges on the rear side of the visual display device, and all of the circular fastener apertures in the flanges of the visual display device, which are illustrated using broken lines, are unclaimed subject matter only and form no part of the claimed design.

1 Claim, 18 Drawing Sheets

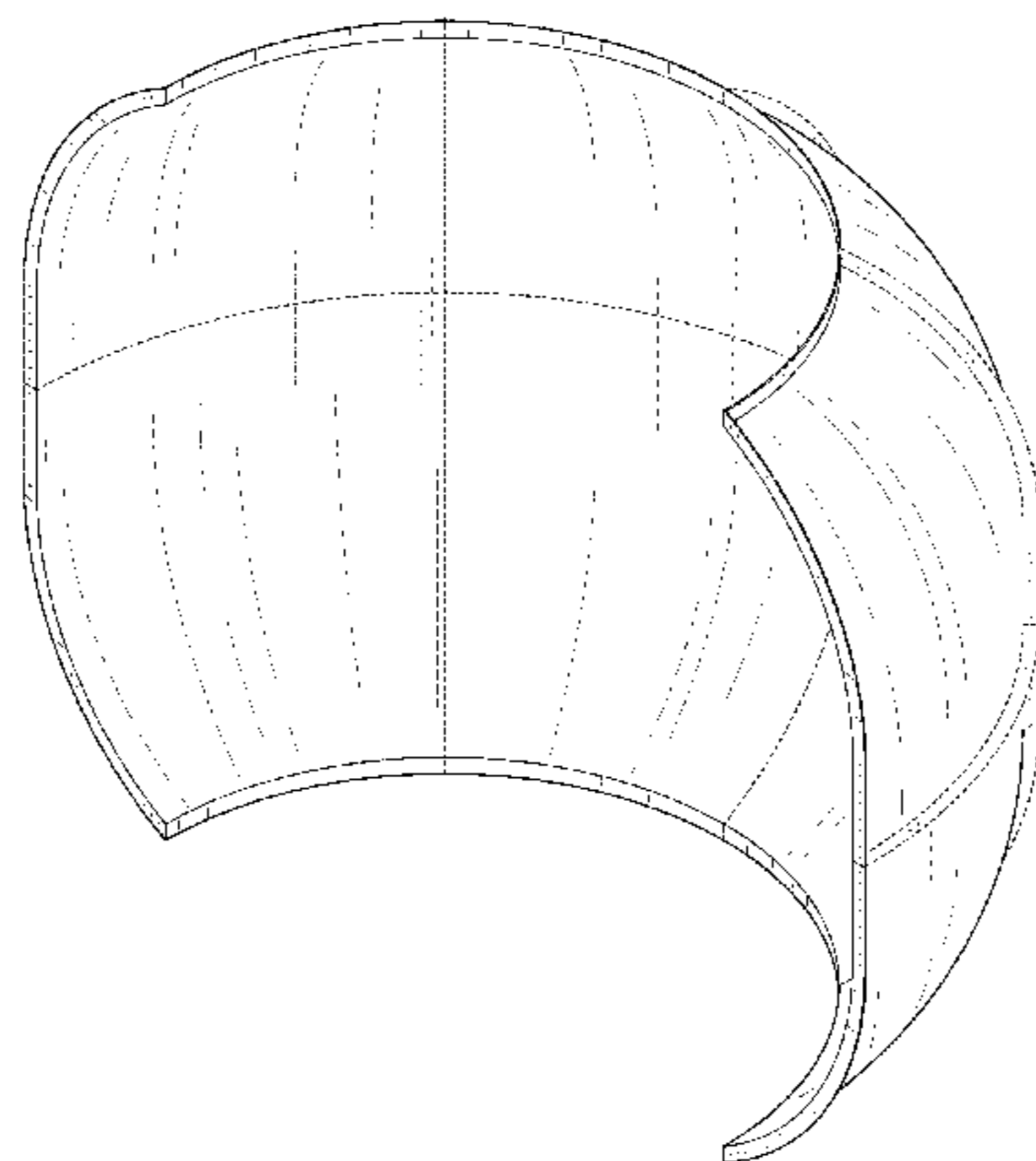

(56)

References Cited

U.S. PATENT DOCUMENTS

D391,118 S	2/1998	Jorgensen	8,700,569 B1	4/2014	Wilson et al.	
D394,188 S	5/1998	Reynaert et al.	8,704,855 B1	4/2014	Berme et al.	
6,038,488 A	3/2000	Barnes et al.	8,764,532 B1	7/2014	Berme	
6,113,237 A	9/2000	Ober et al.	8,847,989 B1	9/2014	Berme et al.	
6,152,564 A	11/2000	Ober et al.	D715,669 S	10/2014	Berme	
6,295,878 B1	10/2001	Berme	8,902,249 B1	12/2014	Wilson et al.	
6,354,155 B1	3/2002	Berme	8,915,149 B1	12/2014	Berme	
6,389,883 B1	5/2002	Berme et al.	D727,189 S *	4/2015	Goh	D10/103
6,936,016 B2	8/2005	Berme et al.	9,032,817 B2	5/2015	Berme et al.	
D645,307 S	9/2011	Shamoon	9,043,278 B1	5/2015	Wilson et al.	
D650,342 S	12/2011	Kuwaharada et al.	9,066,667 B1	6/2015	Berme et al.	
8,181,541 B2	5/2012	Berme	9,081,436 B1	7/2015	Berme et al.	
8,315,822 B2	11/2012	Berme et al.	9,168,420 B1	10/2015	Berme et al.	
8,315,823 B2	11/2012	Berme et al.	9,173,596 B1	11/2015	Berme et al.	
D674,024 S	1/2013	Chiu	2003/0216656 A1	11/2003	Berme et al.	
D689,388 S	9/2013	Berme	2008/0204666 A1	8/2008	Spearman	
D689,389 S	9/2013	Berme	2008/0228110 A1	9/2008	Berme	
8,543,540 B1	9/2013	Wilson et al.	2009/0059096 A1	3/2009	Yamamoto et al.	
8,544,347 B1	10/2013	Berme	2010/0097526 A1	4/2010	Jacob	
8,643,669 B1	2/2014	Wilson et al.	2011/0277562 A1	11/2011	Berme	
			2012/0266648 A1	10/2012	Berme et al.	
			2012/0271565 A1	10/2012	Berme et al.	
			2015/0096387 A1	4/2015	Berme et al.	

* cited by examiner

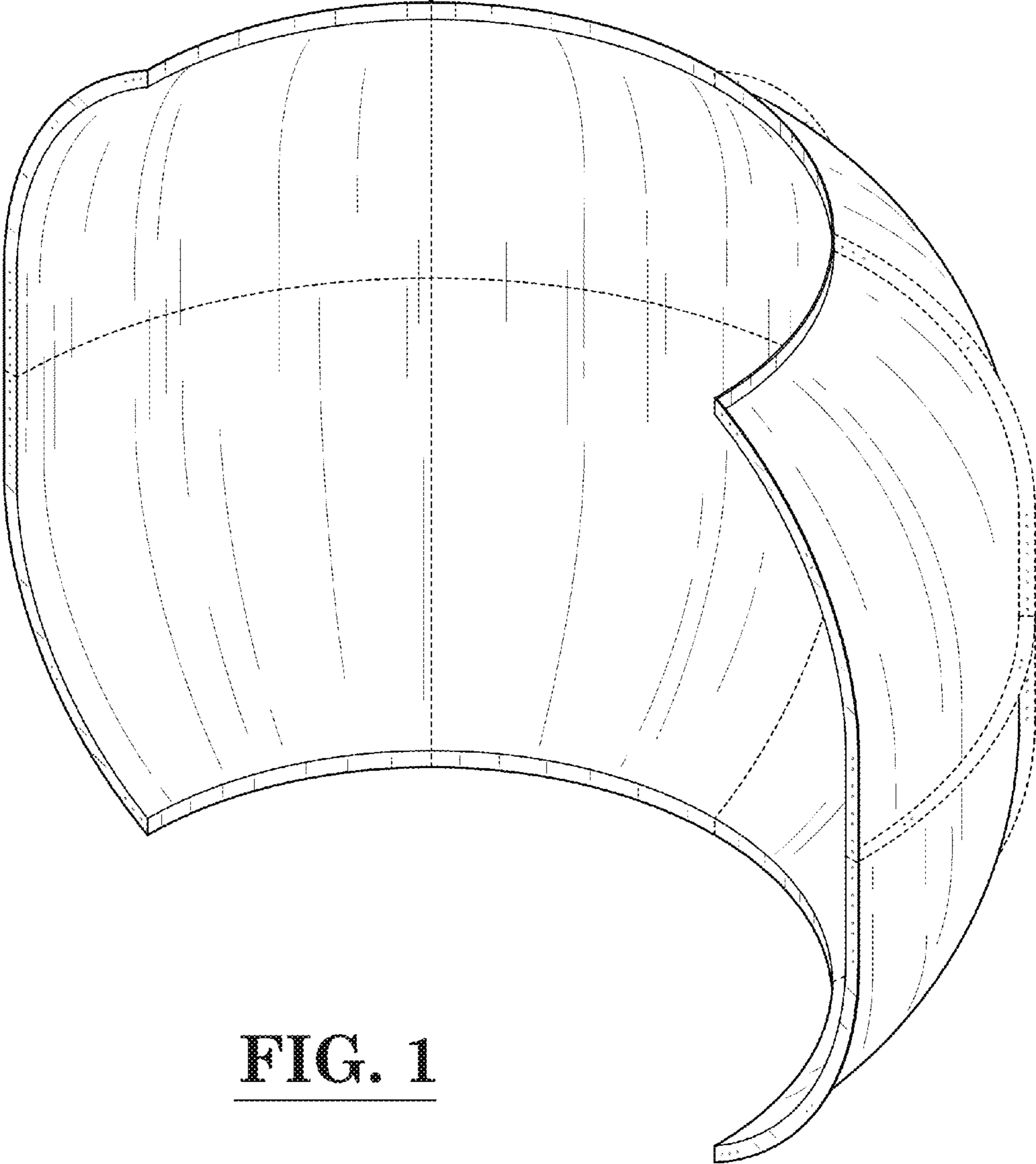

FIG. 1

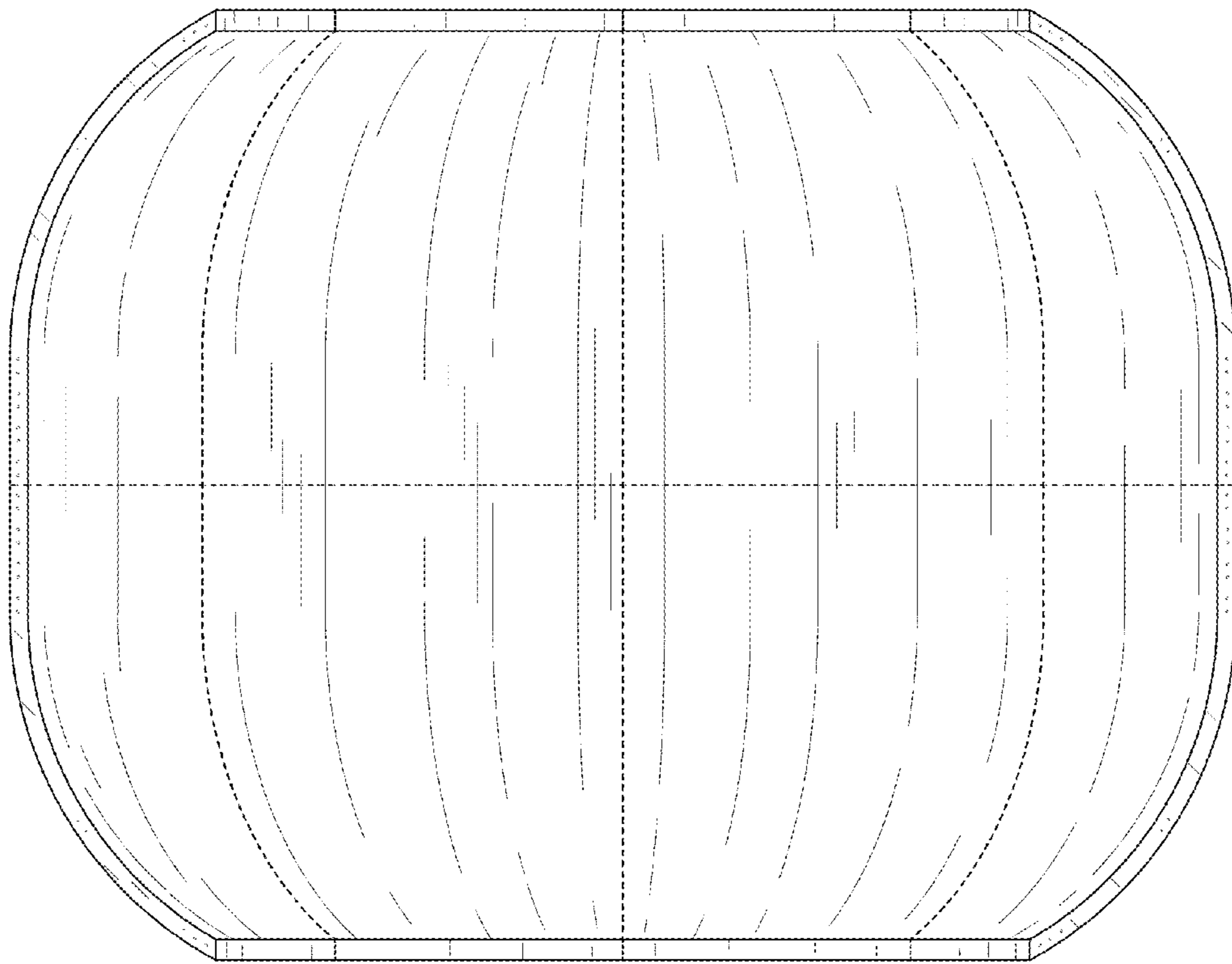

FIG. 2

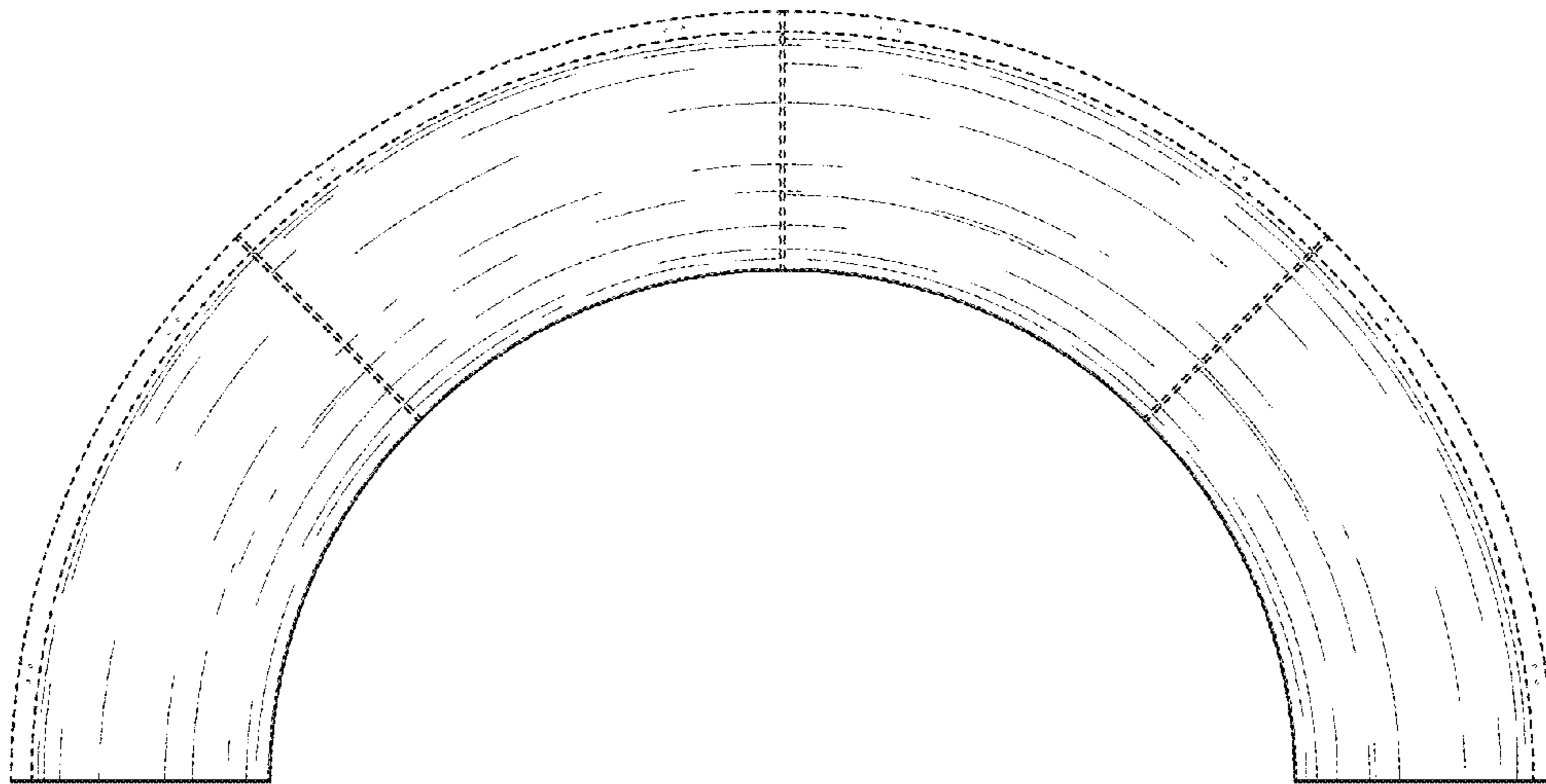

FIG. 3

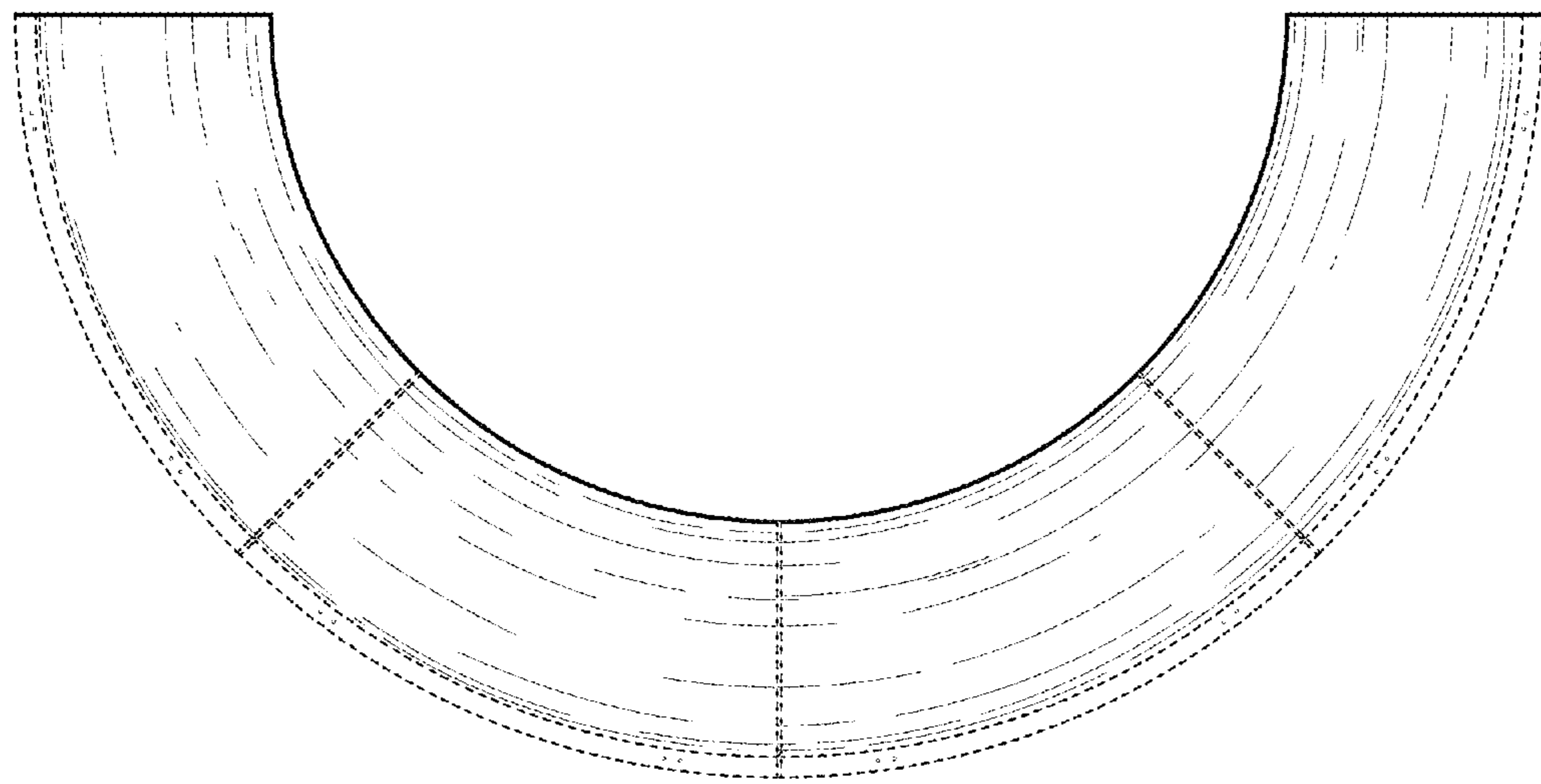

FIG. 4

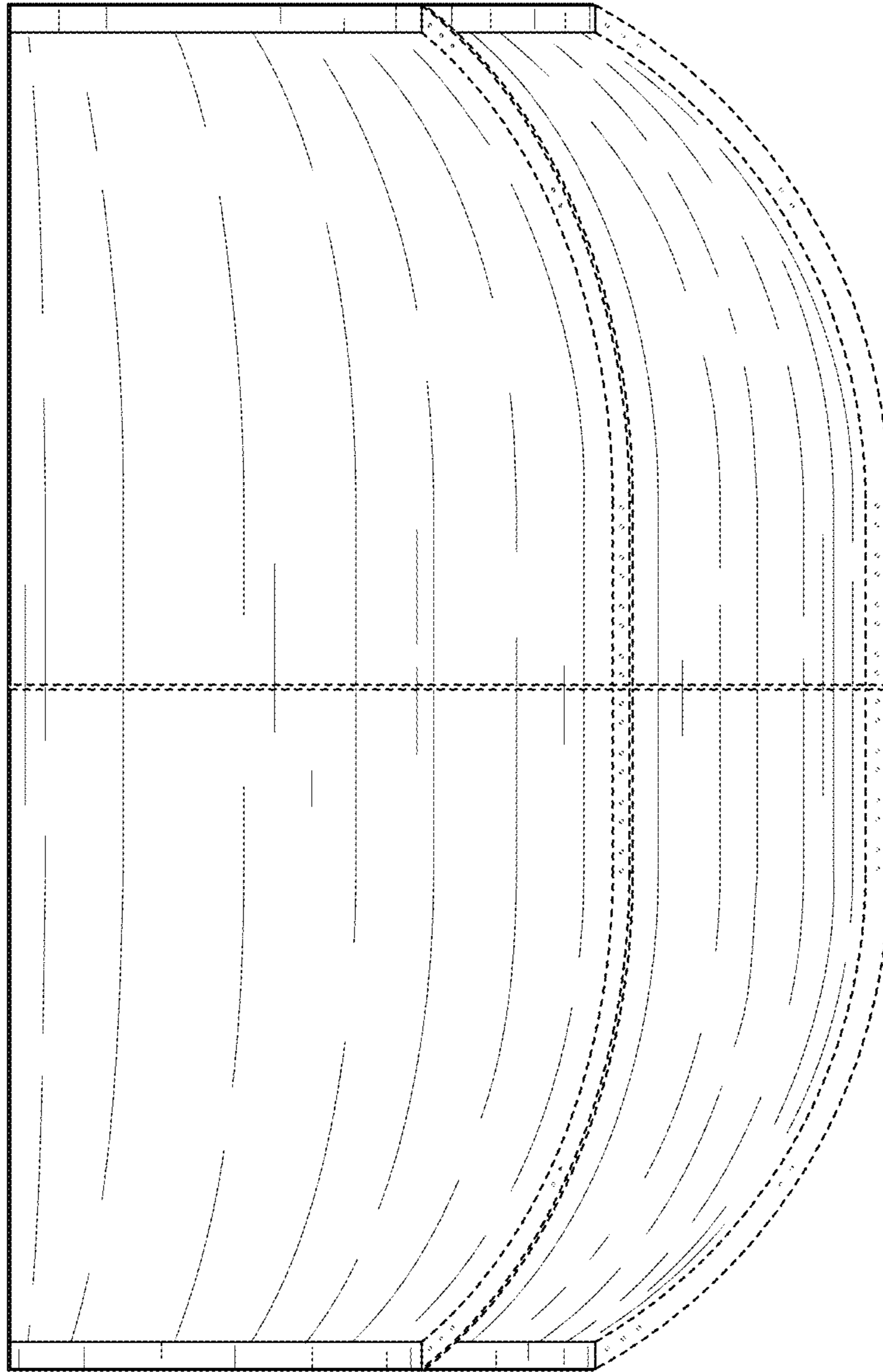

FIG. 5

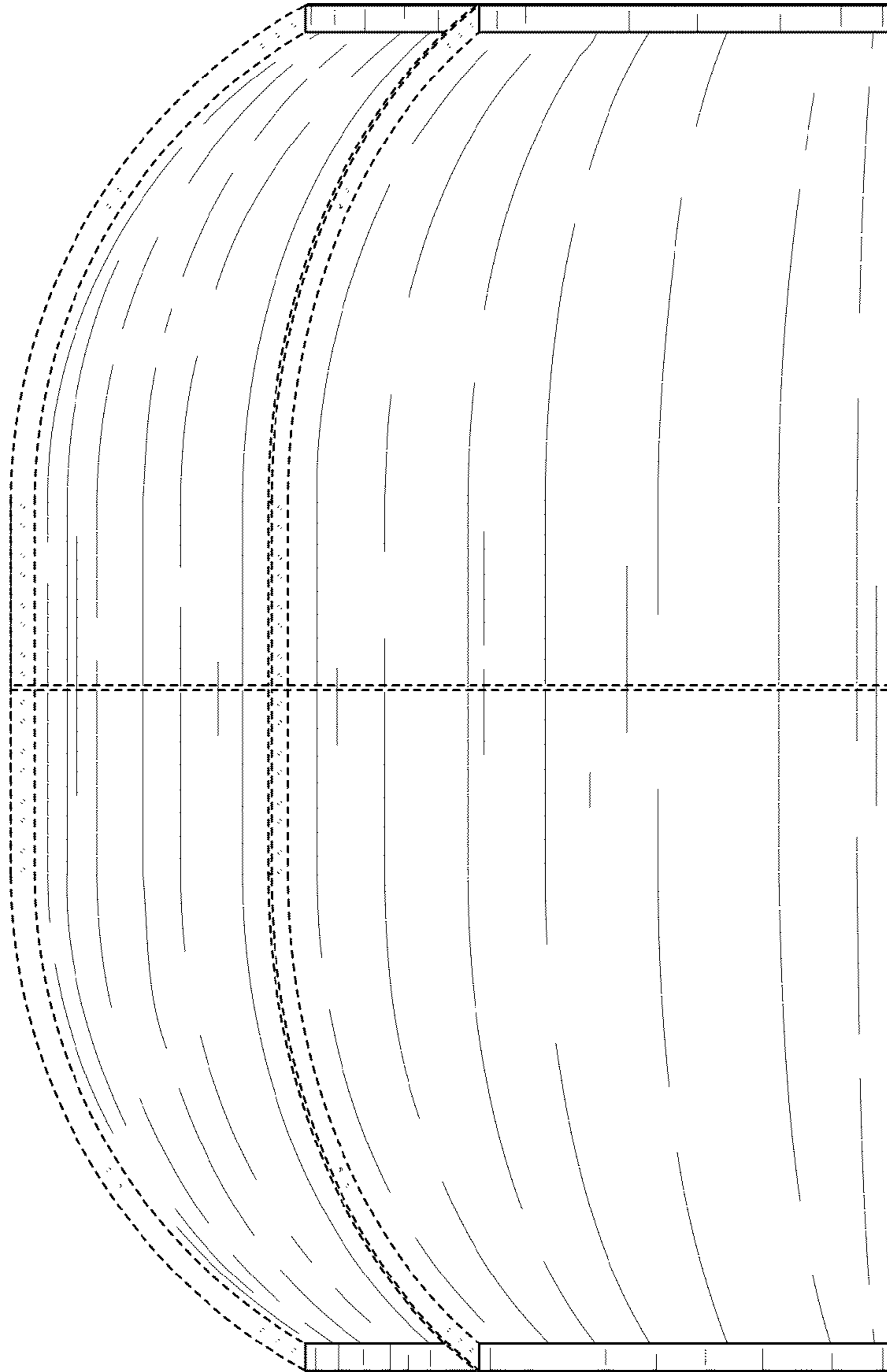

FIG. 6

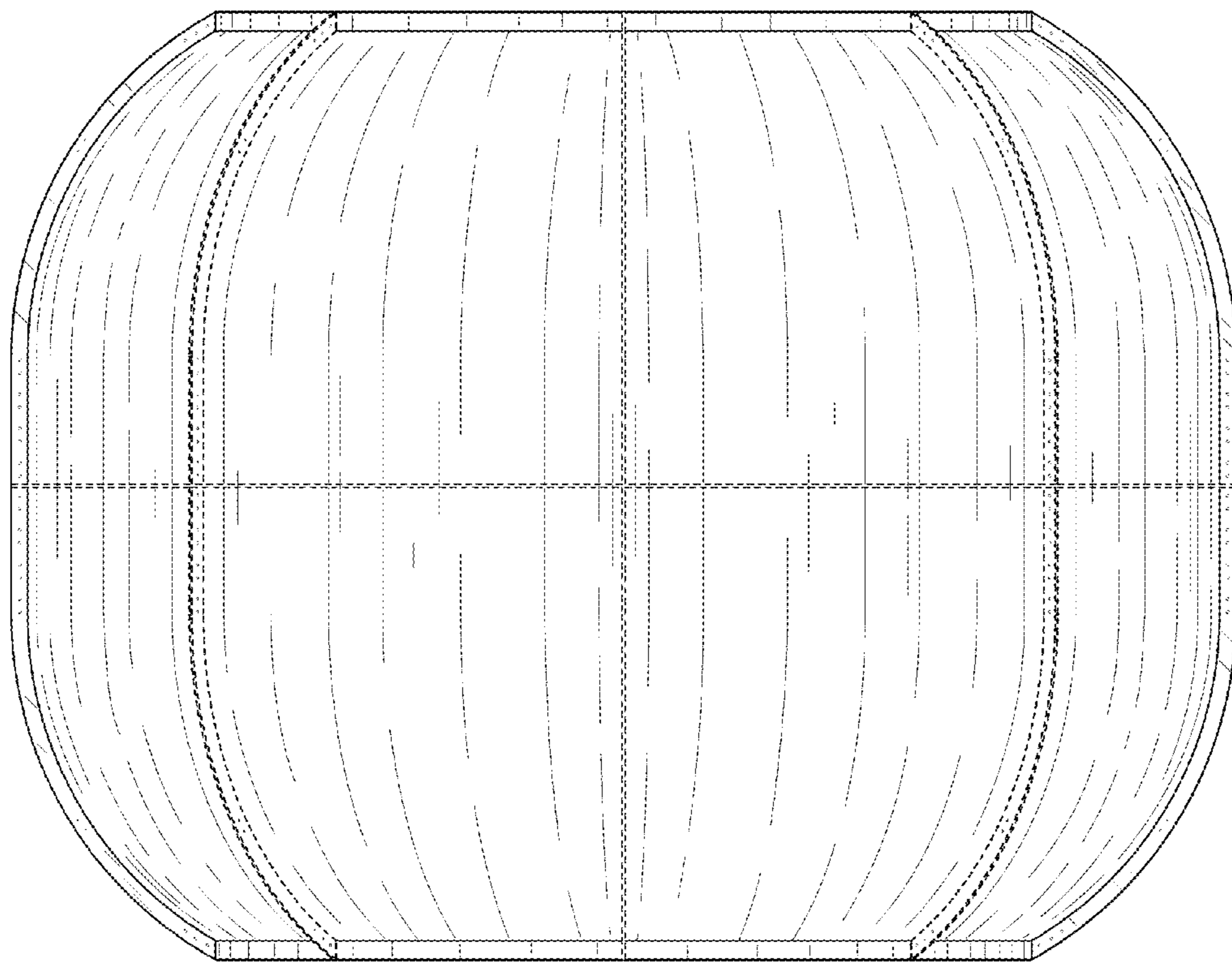

FIG. 7

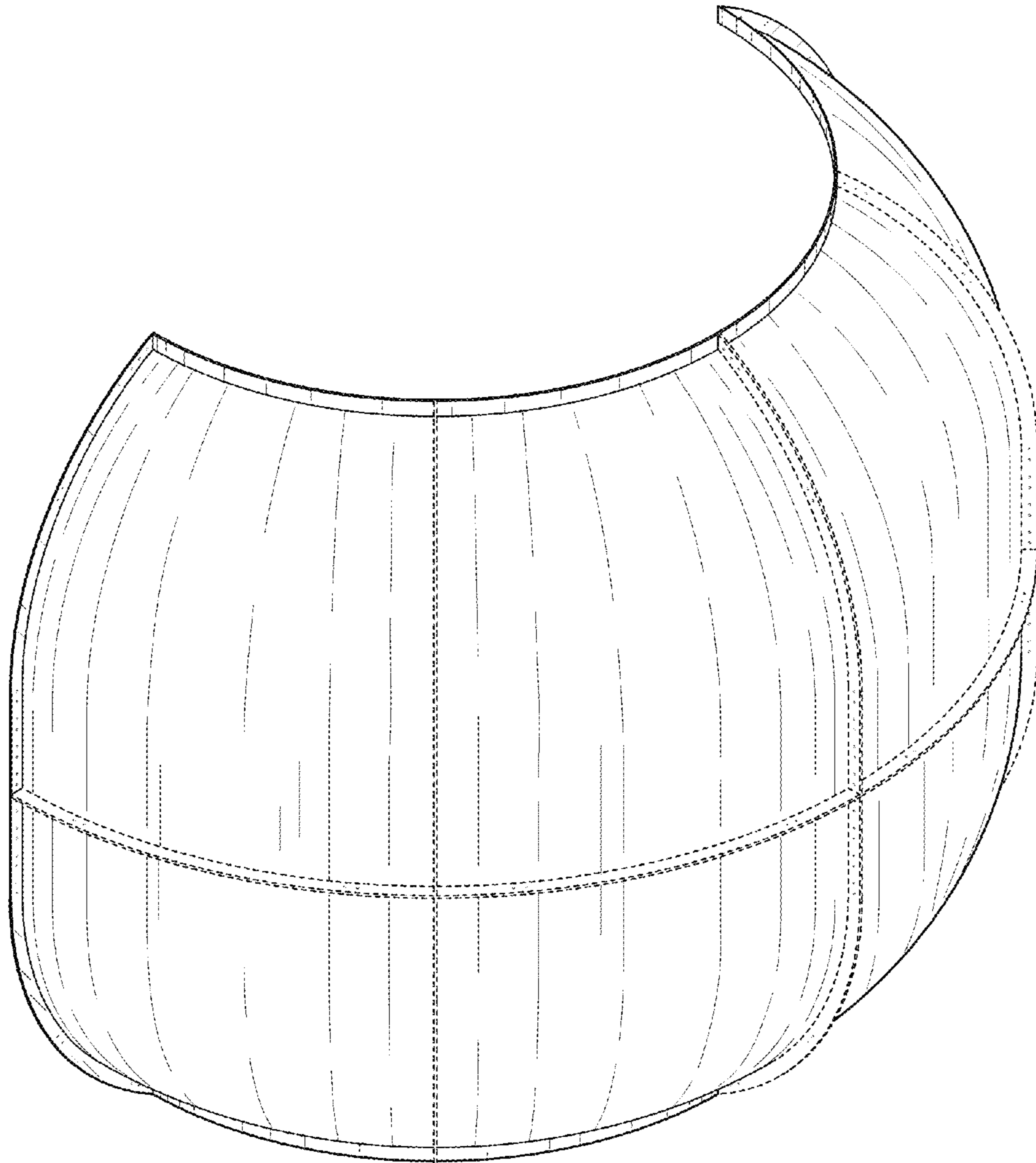

FIG. 8

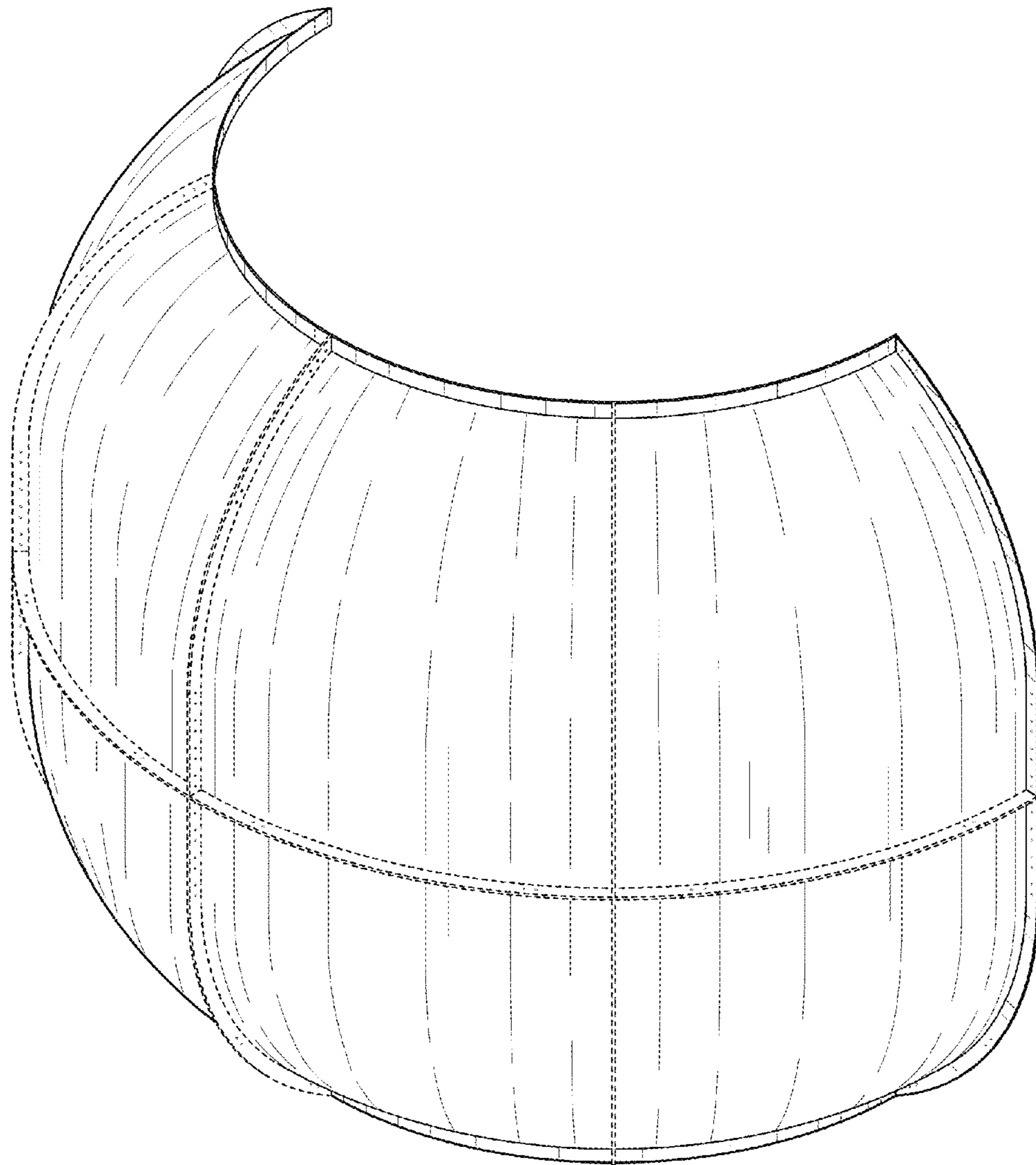

FIG. 9

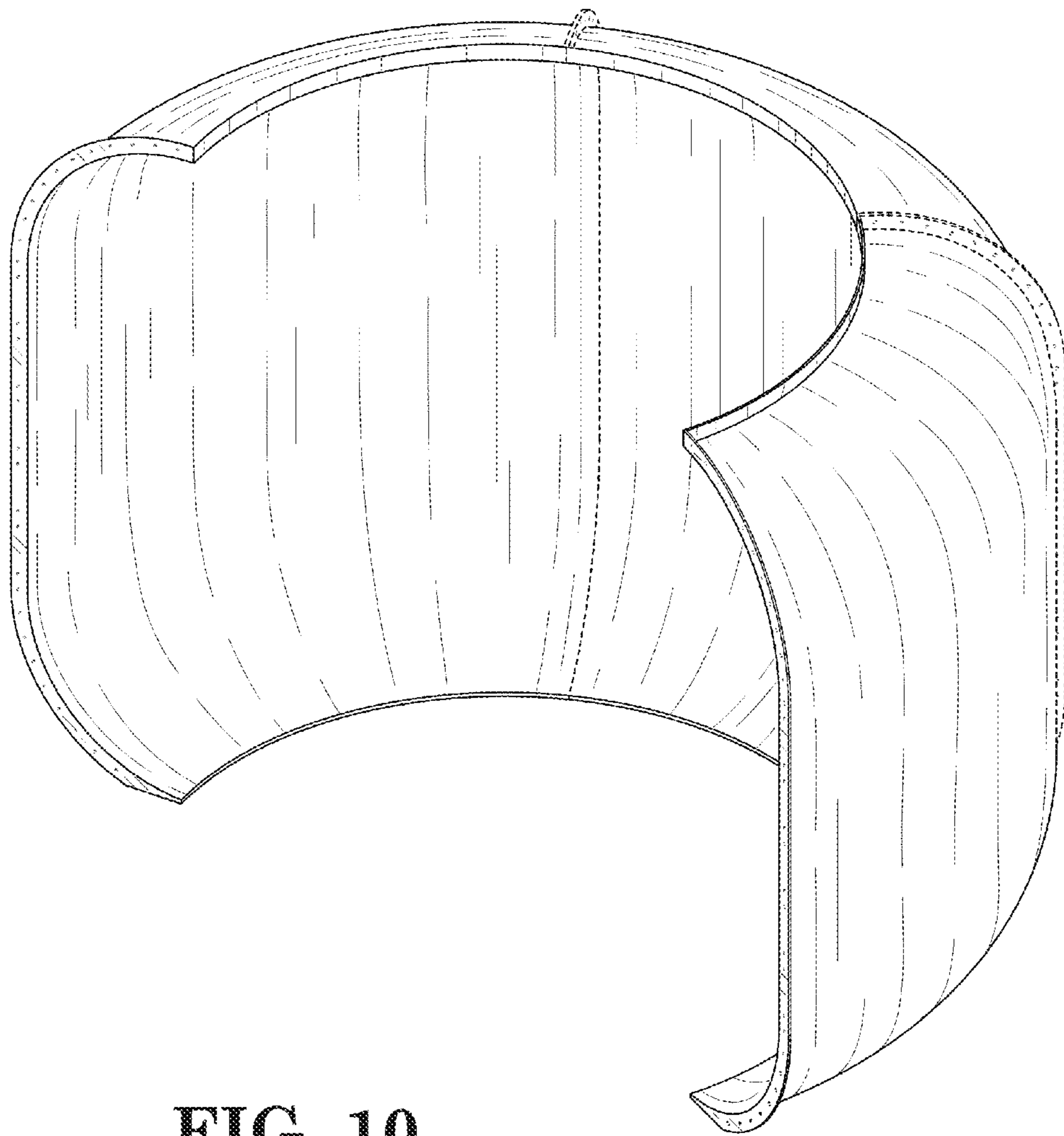

FIG. 10

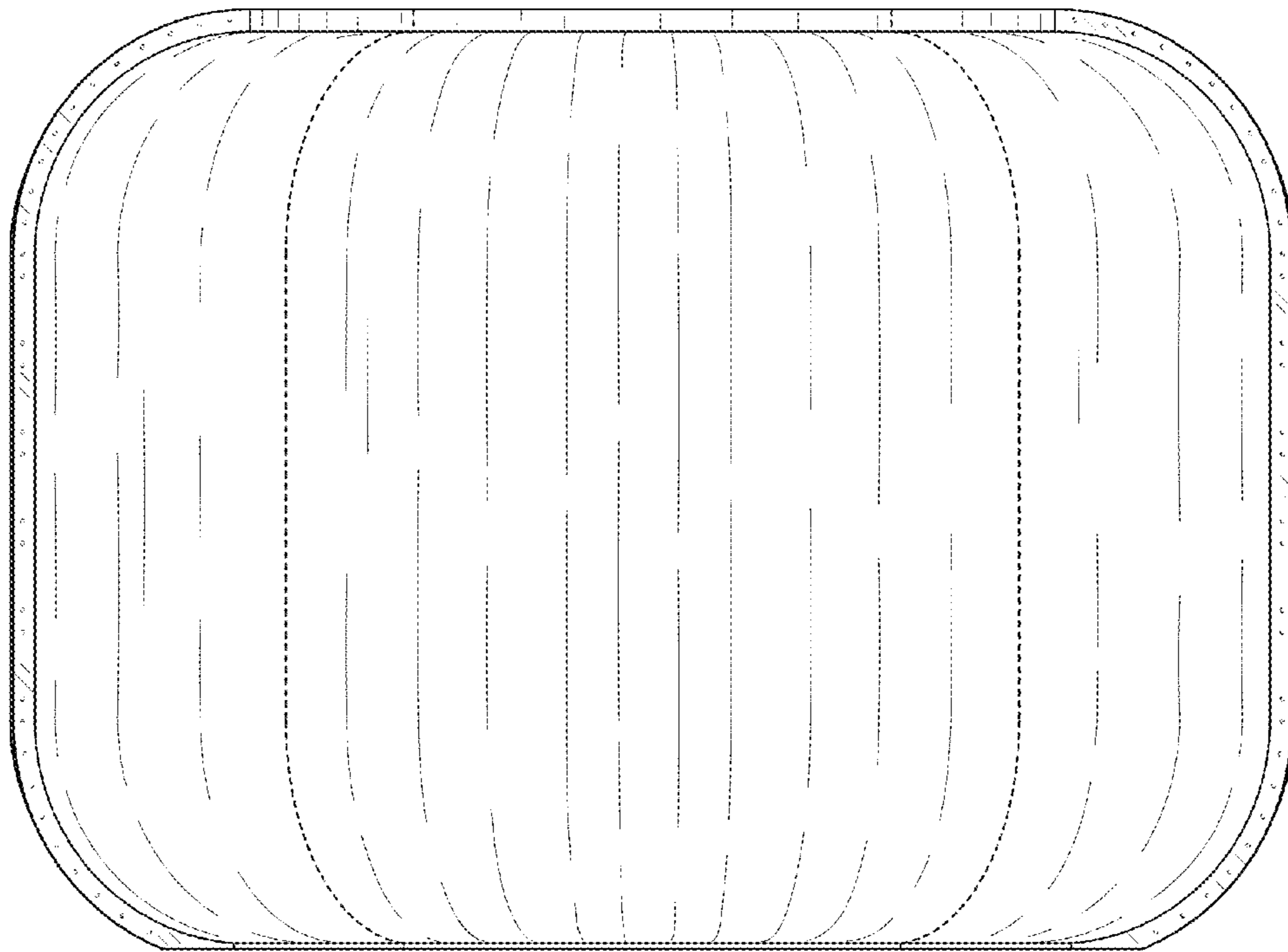

FIG. 11

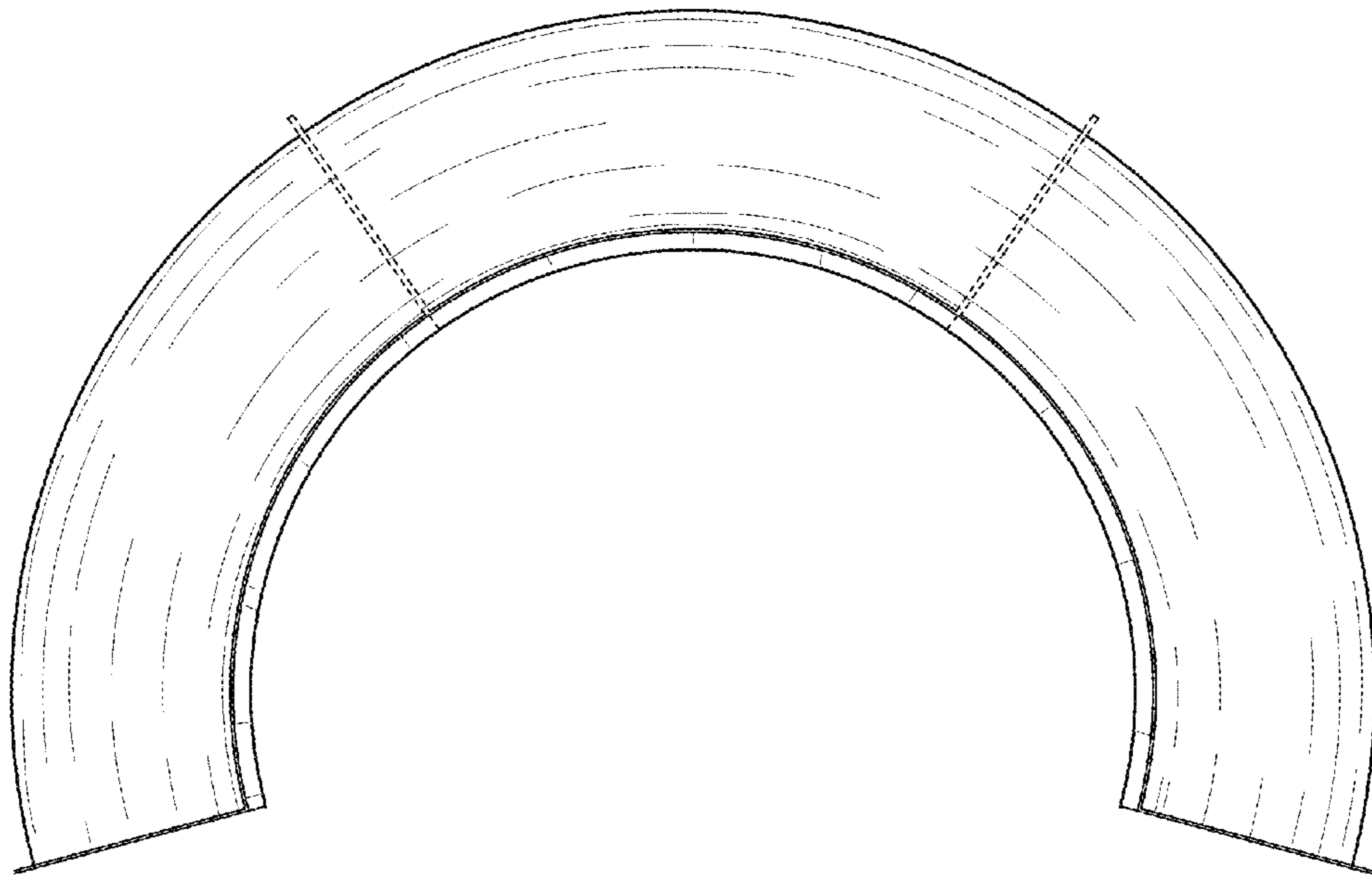

FIG. 12

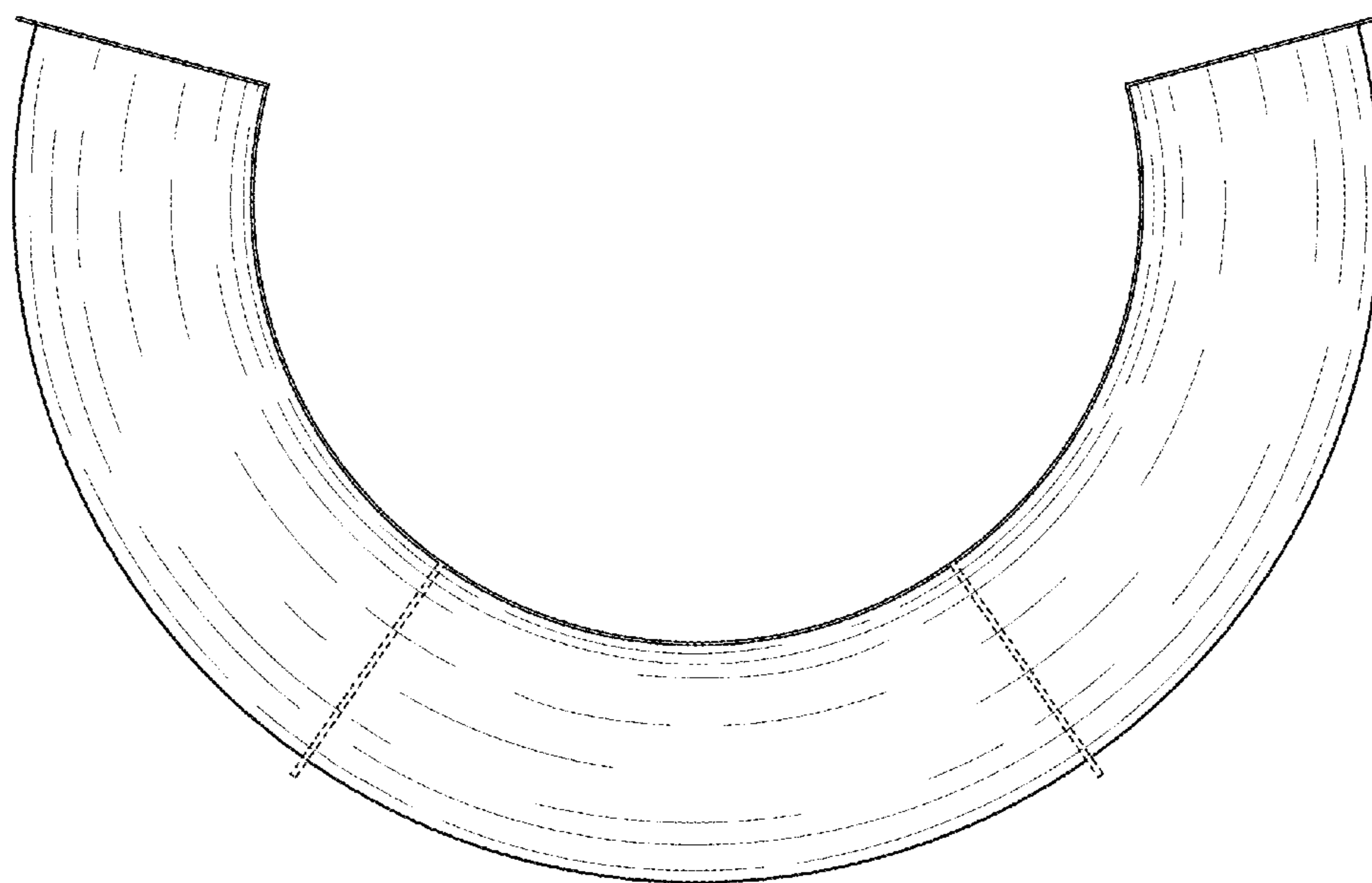

FIG. 13

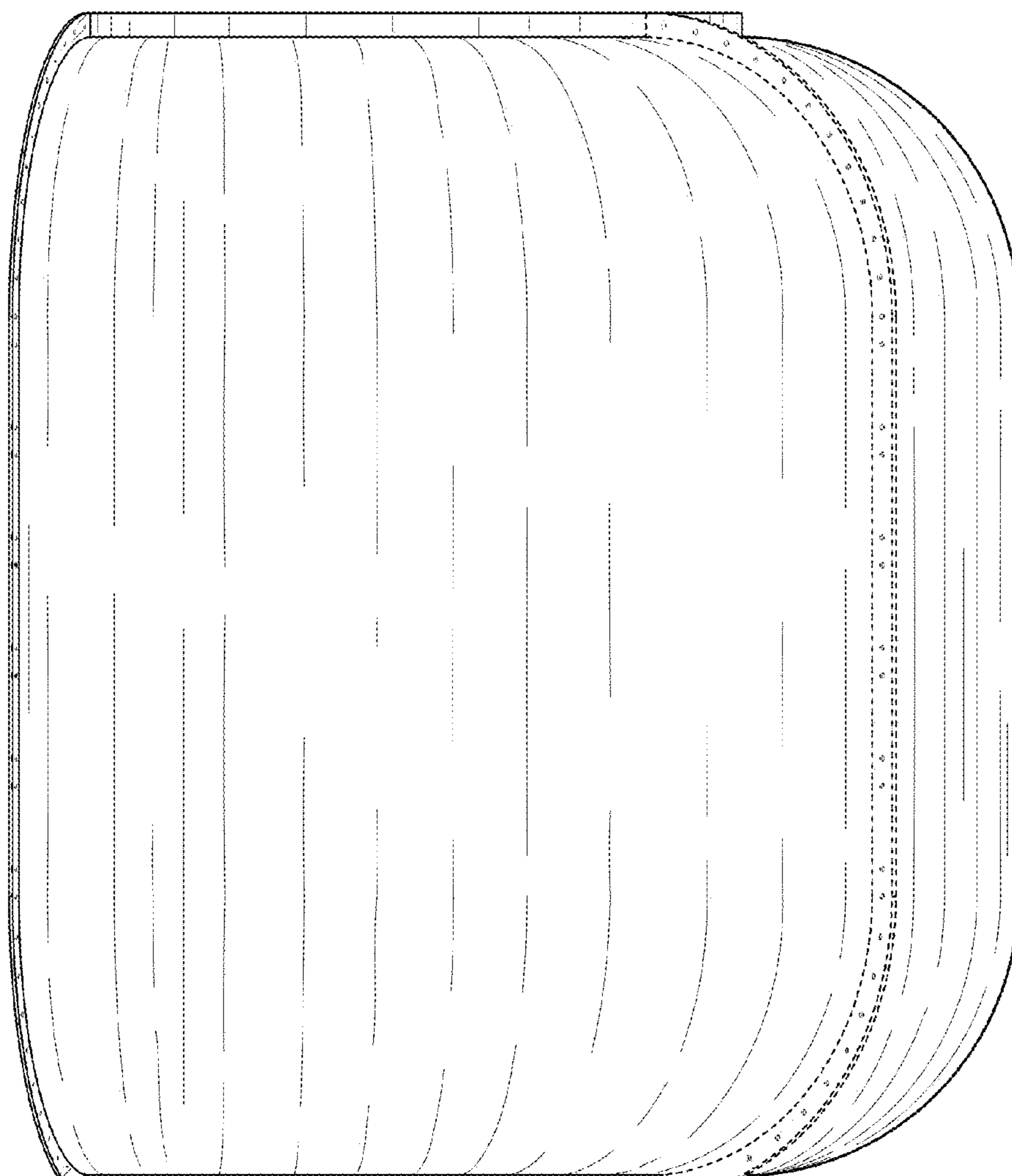

FIG. 14

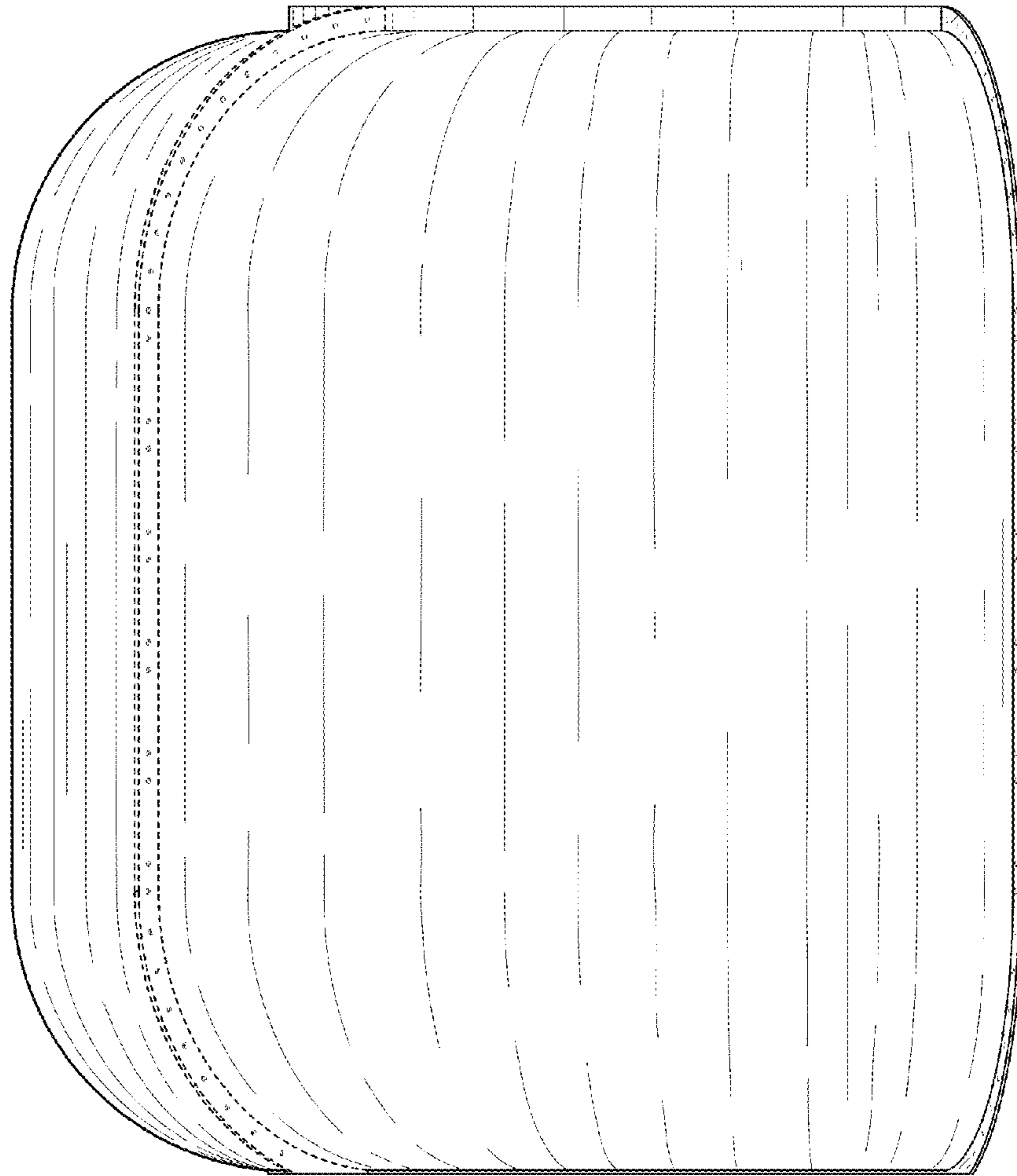

FIG. 15

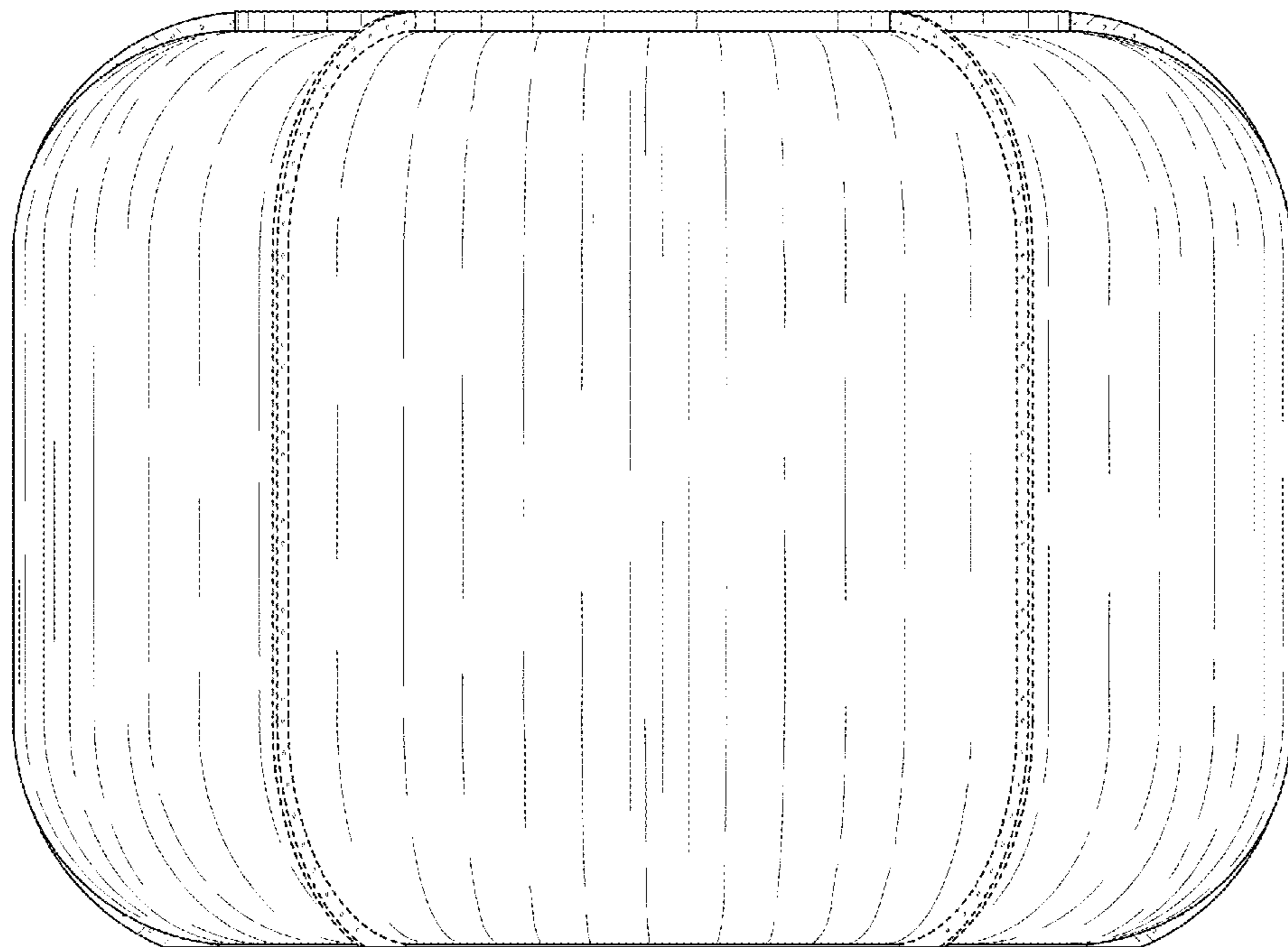

FIG. 16

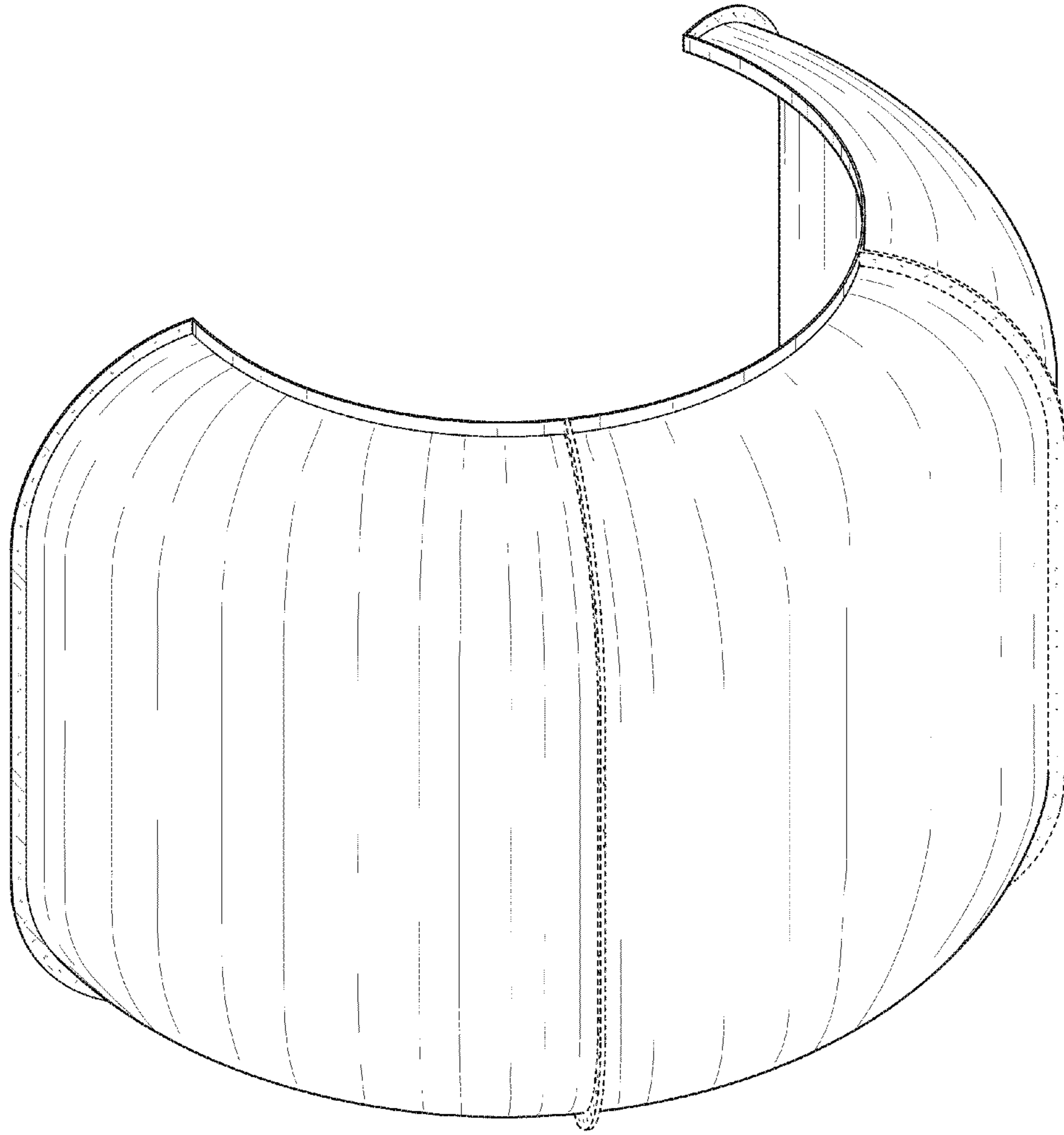

FIG. 17

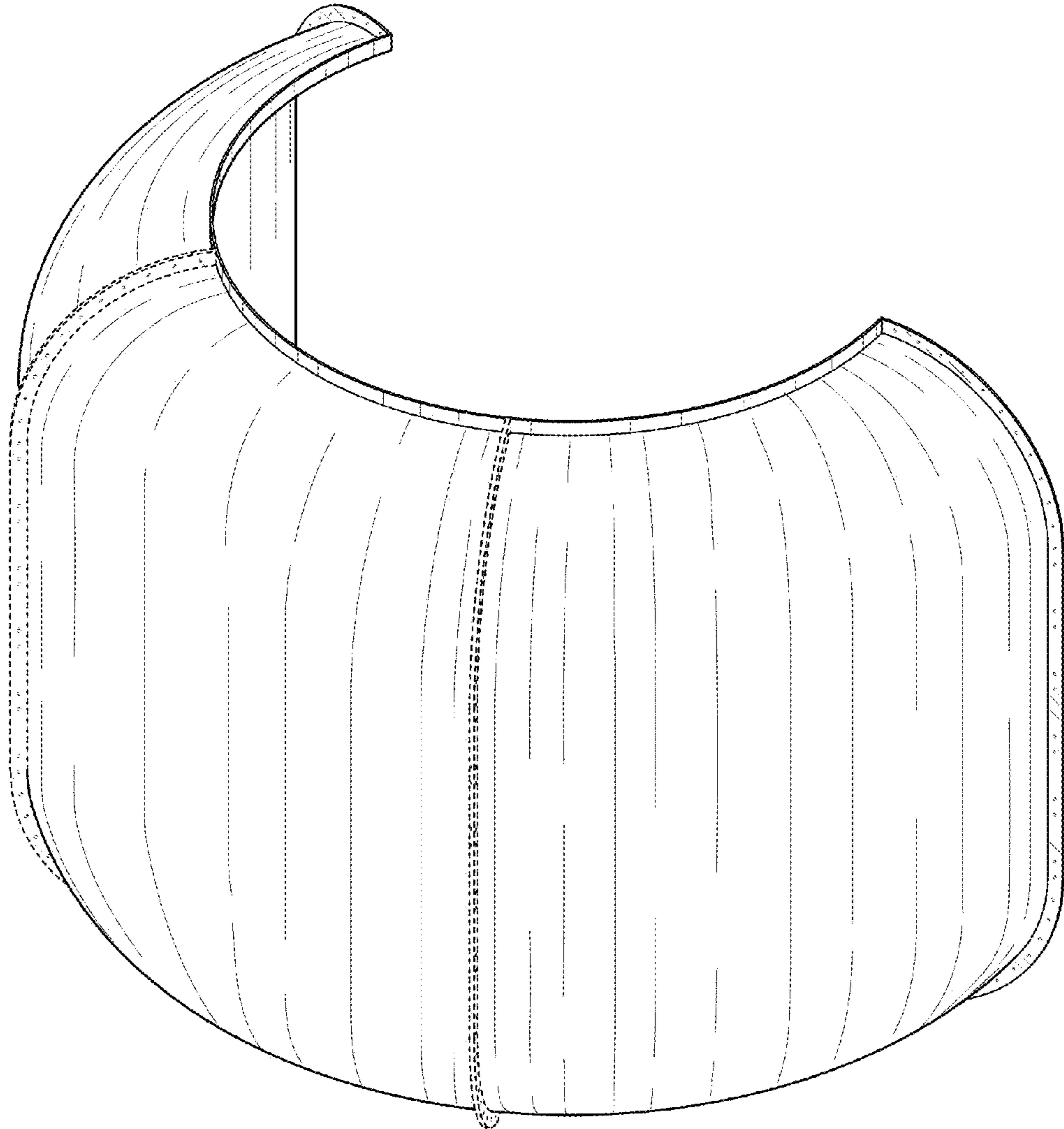

FIG. 18