



US00D755057S

(12) **United States Design Patent**
Mutter

(10) **Patent No.:** **US D755,057 S**
(45) **Date of Patent:** **** May 3, 2016**

(54) **REFILL BOTTLE**

(71) Applicant: **LOEC, Inc.**, Greensboro, NC (US)

(72) Inventor: **Douglas Mutter**, Edinburgh (GB)

(73) Assignee: **FONTEM HOLDINGS 4 B.V.**,
Amsterdam (NL)

(**) Term: **14 Years**

(21) Appl. No.: **29/495,021**

(22) Filed: **Jun. 26, 2014**

(51) **LOC (10) Cl.** **09-01**

(52) **U.S. Cl.**
USPC **D9/566; D9/520; D9/529; D9/550;**
D9/573

(58) **Field of Classification Search**
USPC **D3/202, 203.2, 901; D4/116; D7/313,**
D7/509-511, 515, 590-560, 601-612,
D7/619.1; D9/516, 519, 520, 522, 523,
D9/526, 529, 530, 535, 544, 550, 558, 559,
D9/560, 561, 563, 566, 567, 569, 571, 574,
D9/682, 686, 687, 689, 719, 774; D19/66,
D19/93, 120, 181; D23/211.1-211.2, 366;
D24/121, 124, 170, 197, 224; D28/4,
D28/7, 20, 66, 76, 82, 83, 85, 88, 89, 91.1;
D6/515, 518, 522, 523, 535, 541, 542;
222/182, 209, 252; 215/62.22, 220,
215/283-285, 329, 379, 396, 398; 220/674,
220/710, 837
CPC **A45D 33/003; A45D 33/22; A45D 34/00;**
A45D 40/30; A61J 1/03; A61J 1/05; A47G
19/22; A47G 19/2205; A47G 19/2266;
B65D 1/02; B65D 1/0223; B65D 1/08;
B65D 1/10

See application file for complete search history.

(56) **References Cited**

U.S. PATENT DOCUMENTS

D243,705 S * 3/1977 Lyman D24/224
D311,866 S * 11/1990 Karlin D9/523

(Continued)

FOREIGN PATENT DOCUMENTS

GB 3024837 * 6/2006

OTHER PUBLICATIONS

Triangle Fragrance Bottle: Announced Mar. 20, 2013 [online], site visited Aug. 20, 2015. Available from Internet URL: <http://www.starglassbottle.com/eproducts/797.html>.*

Primary Examiner — Thomas Johannes
Assistant Examiner — Catherine Posthauer
(74) *Attorney, Agent, or Firm* — Dykema Gossett PLLC

(57) **CLAIM**

The ornamental design for a refill bottle, as shown and described.

DESCRIPTION

FIG. 1 is an isometric view of a refill bottle showing this new design.

FIG. 2 is a front view of the refill bottle depicted in FIG. 1.

FIG. 3 is a left side view of the refill bottle depicted in FIG. 1.

FIG. 4 is a top view of the refill bottle depicted in FIG. 1.

FIG. 5 is a rear view of the refill bottle depicted in FIG. 1.

FIG. 6 is a right side view of the refill bottle depicted in FIG. 1; and,

FIG. 7 is a bottom view of the refill bottle depicted in FIG. 1.

The broken lines are shown for the purpose of illustrating portions of the refill bottle that form no part of the claimed design.

The “blu” logo in FIGS. 1 and 2 is a registered trademark of Fontem Holdings 4 B.V. and the “SKYCIG” logo in FIGS. 1 and 2 is a registered trademark of Cygnet UK Trading Limited.

1 Claim, 2 Drawing Sheets

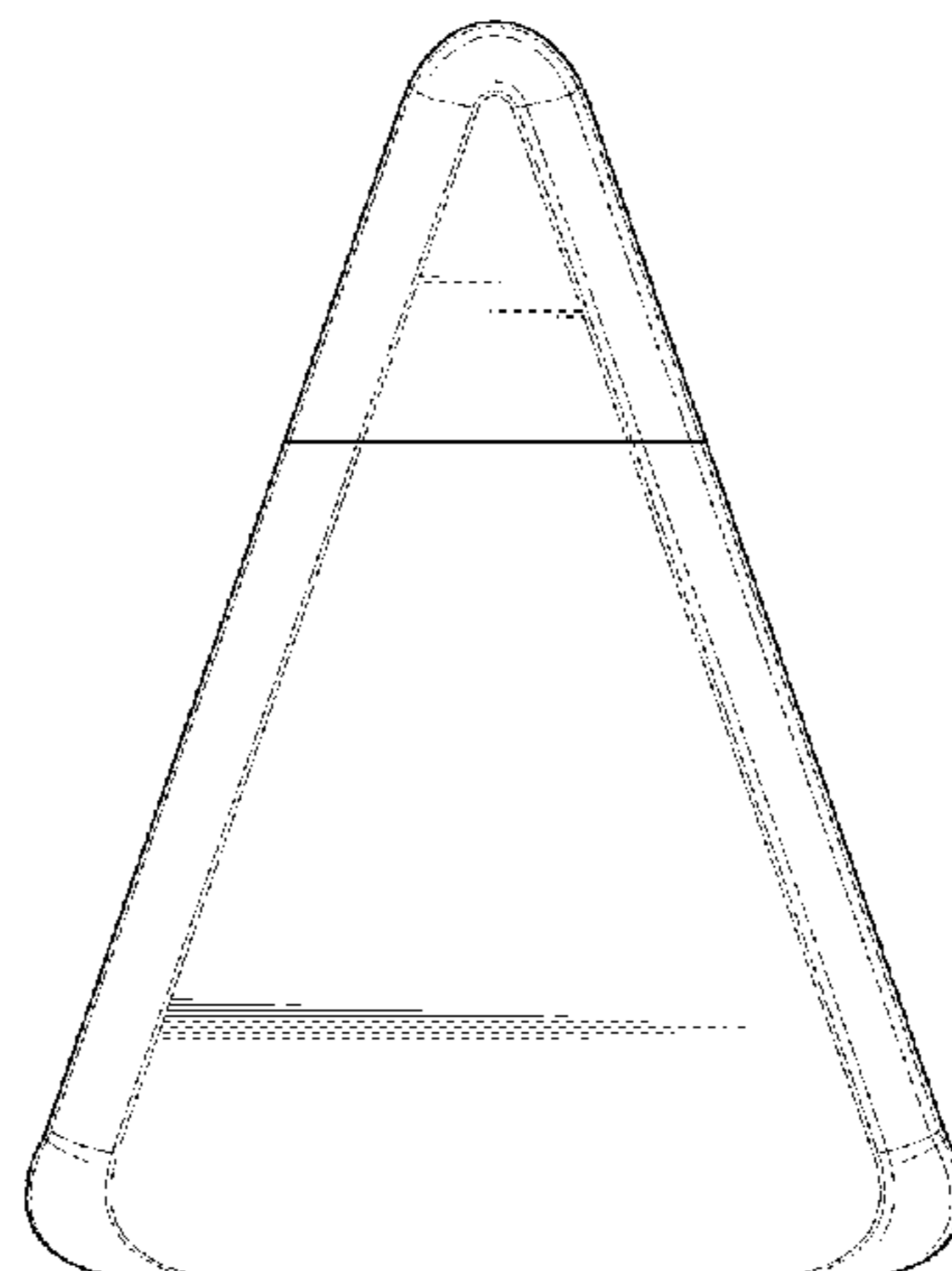
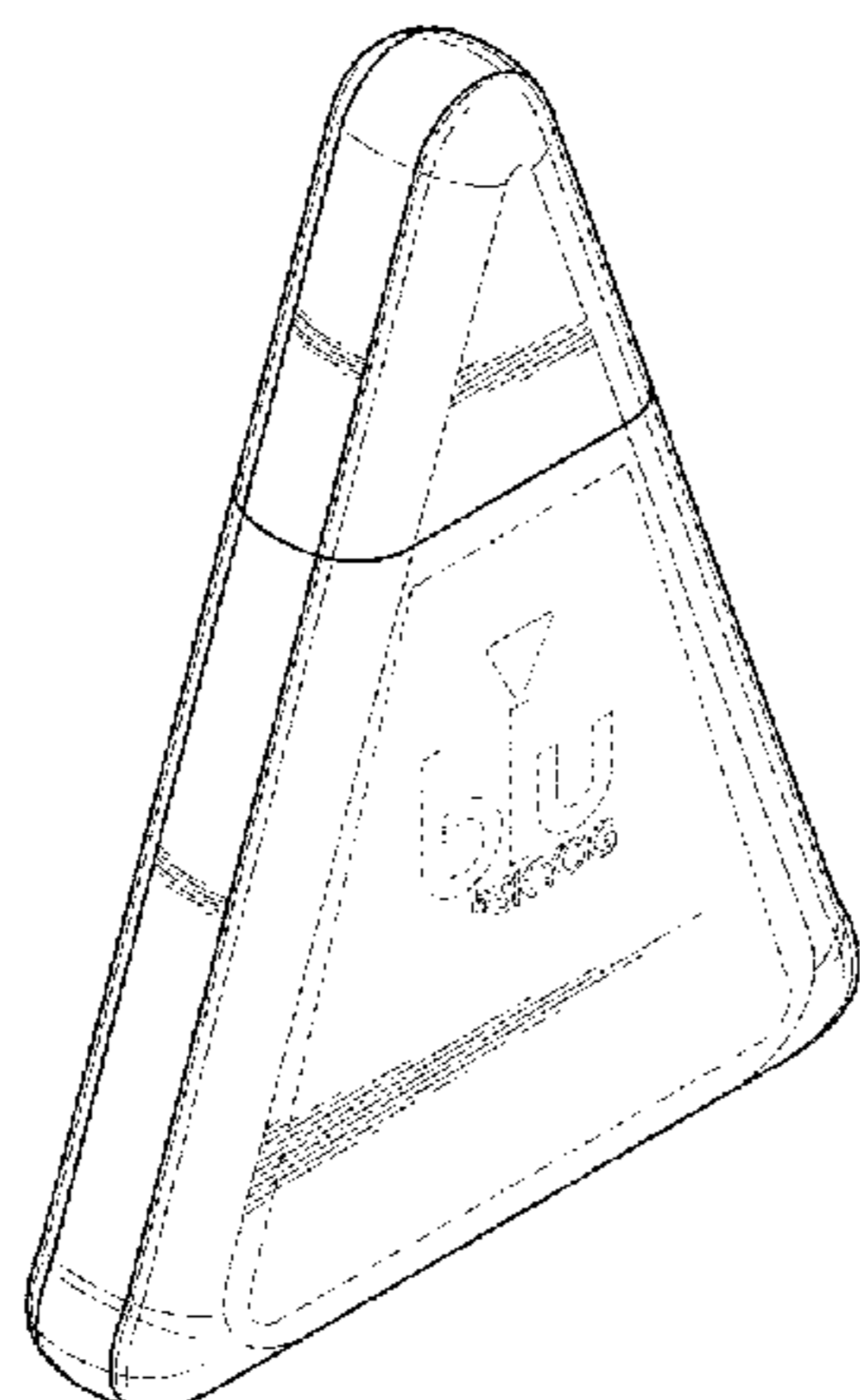

(56)

References Cited

U.S. PATENT DOCUMENTS

D330,218 S *	10/1992	Kimura	D19/66	D570,697 S *	6/2008	Wagner	D9/535
D440,313 S *	4/2001	Smith	D24/170	D596,280 S *	7/2009	Shaw	D23/366
D525,134 S *	7/2006	Grant	D9/516	D631,751 S *	2/2011	Fox et al.	D9/529
D562,385 S *	2/2008	Camillo	D19/181	D653,960 S *	2/2012	Fox	D9/561
				2002/0050482 A1 *	5/2002	Kamdar et al.	215/379

* cited by examiner

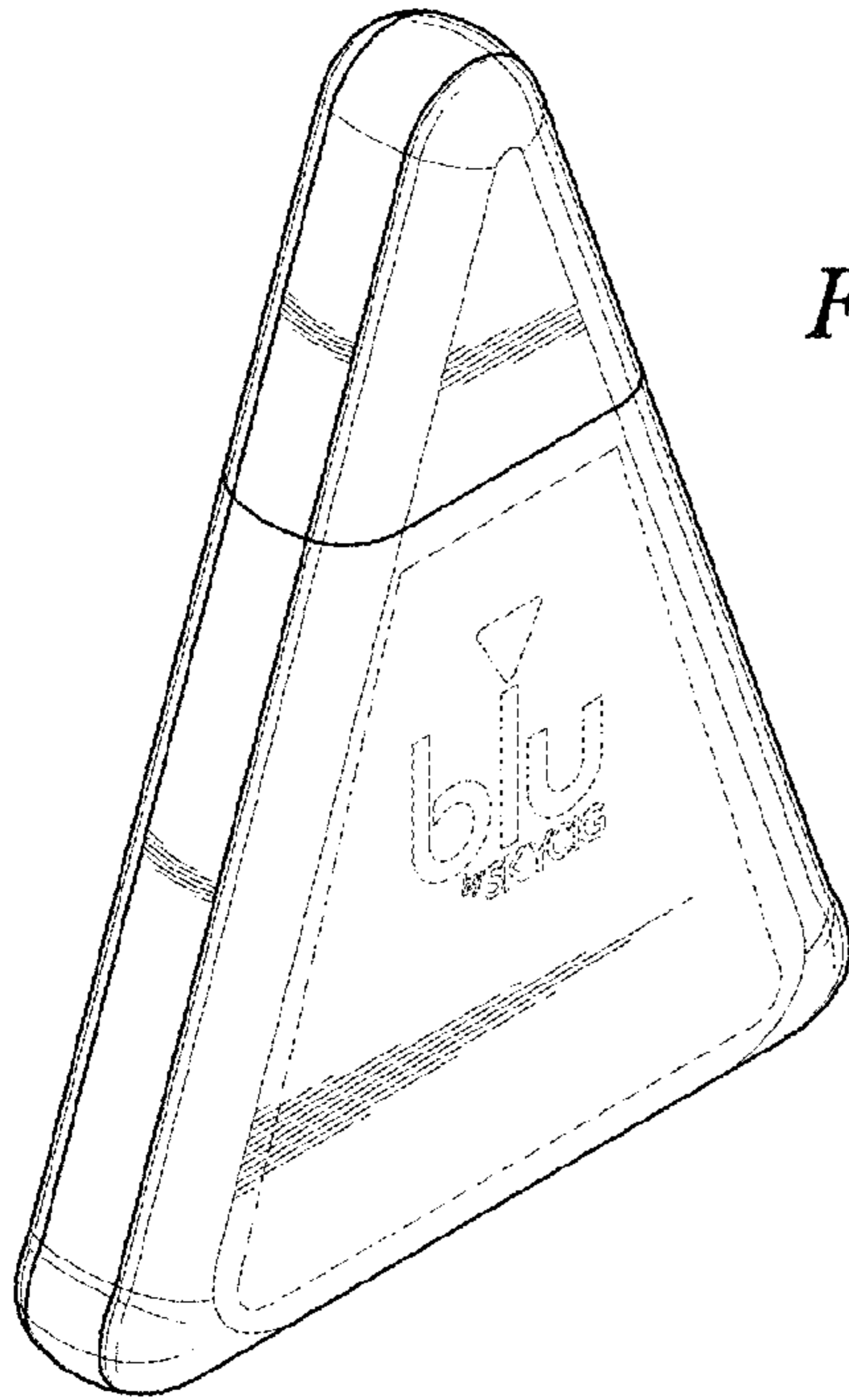

FIG. 1

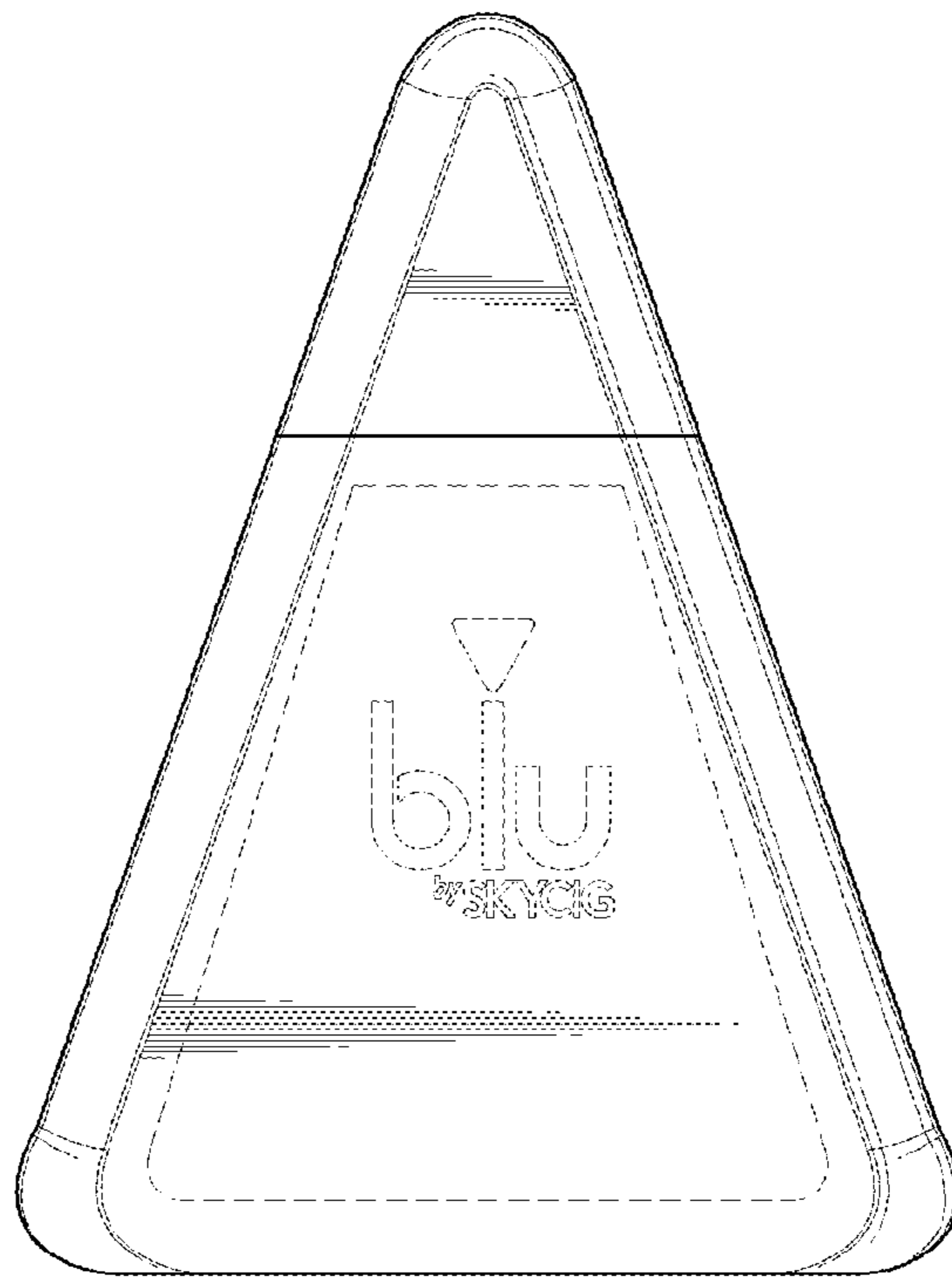

FIG. 2

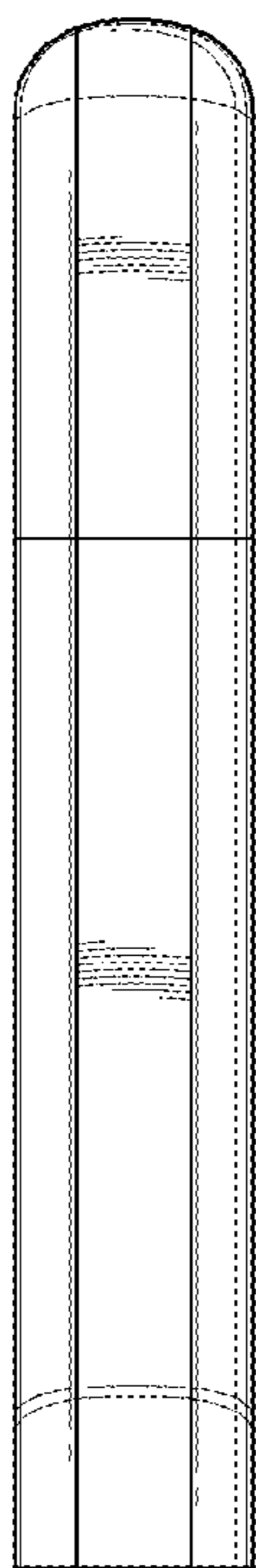

FIG. 3

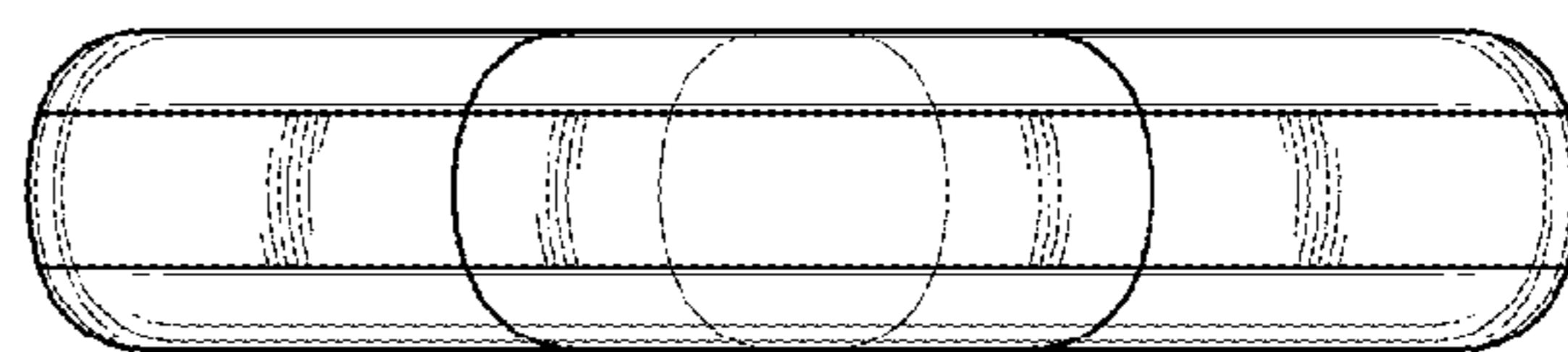

FIG. 4

FIG. 5

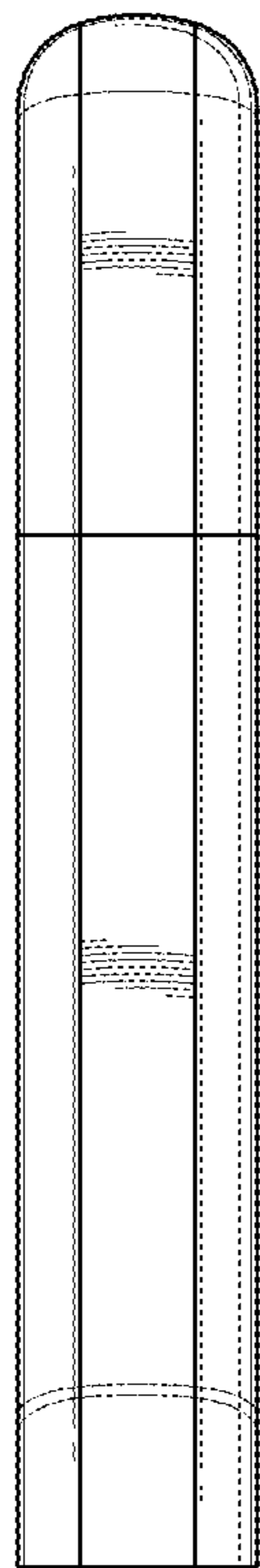
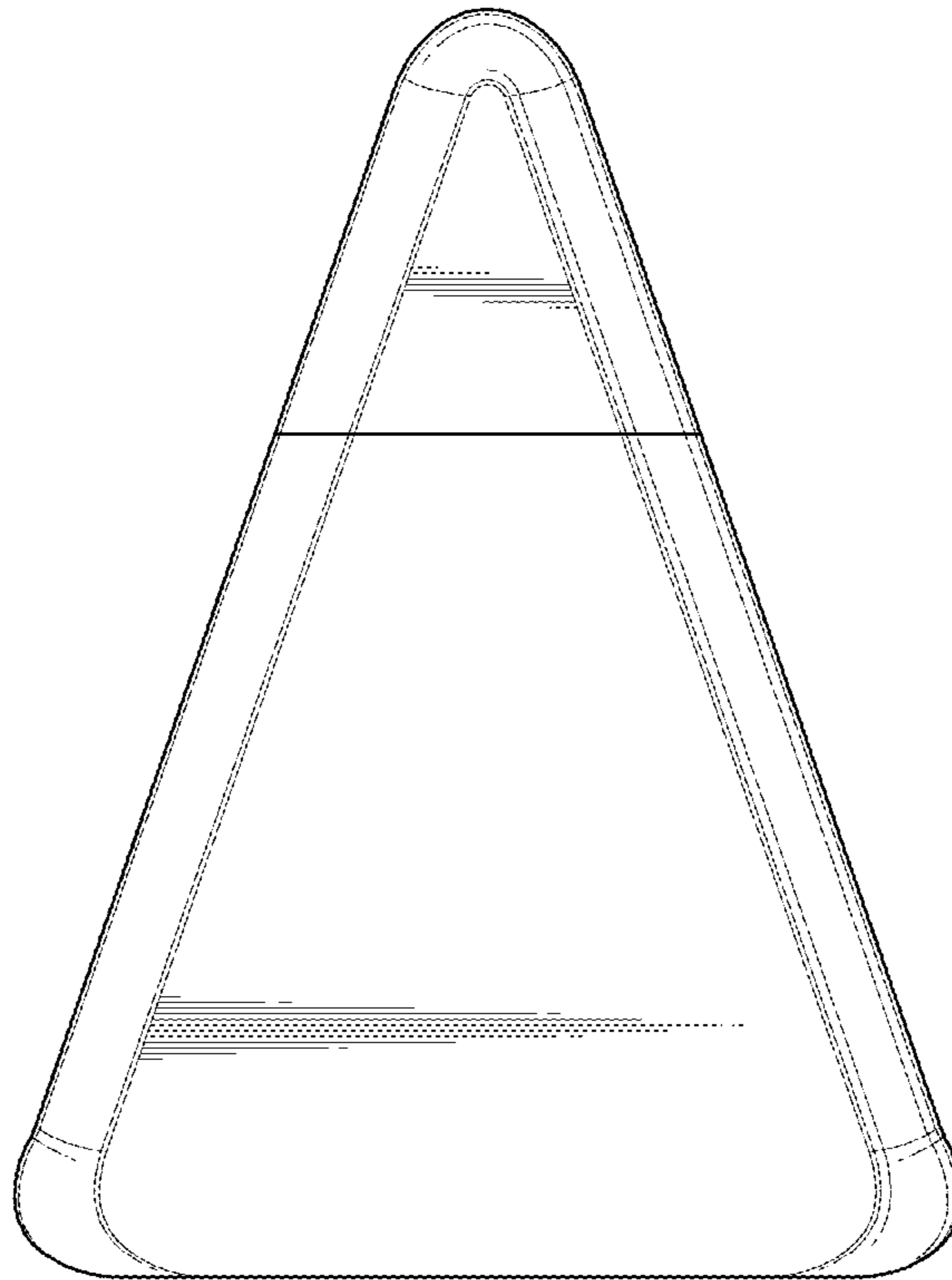

FIG. 6

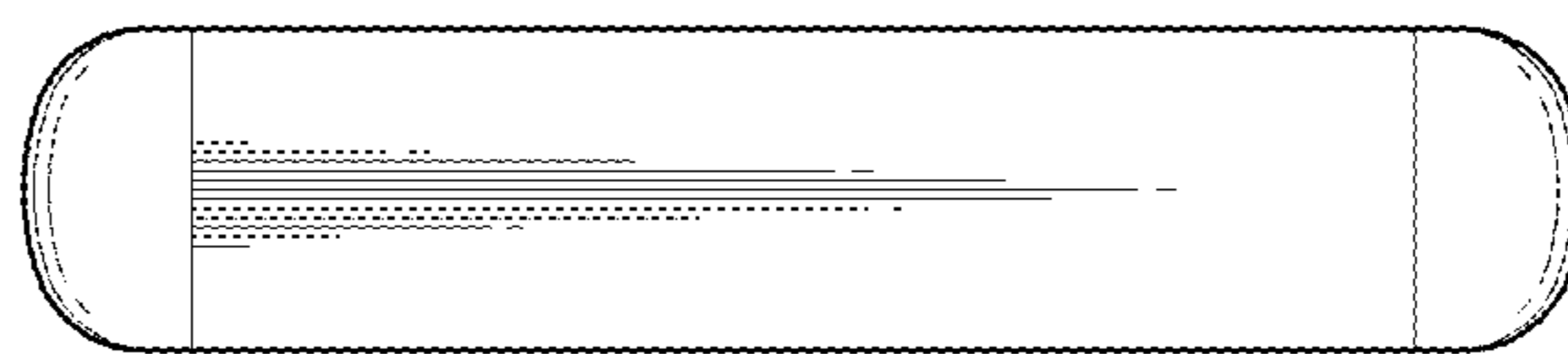

FIG. 7