

US00D755052S

(12) **United States Design Patent**
Murata

(10) **Patent No.:** **US D755,052 S**

(45) **Date of Patent:** **** May 3, 2016**

(54) **BOTTLE**

(71) Applicant: **Ippei Murata**, Tokyo (JP)

(72) Inventor: **Ippei Murata**, Tokyo (JP)

(73) Assignee: **SHISEIDO CO., LTD.**, Tokyo (JP)

(**) Term: **14 Years**

(21) Appl. No.: **29/497,239**

(22) Filed: **Jul. 22, 2014**

(51) **LOC (10) Cl.** **09-01**

(52) **U.S. Cl.**
USPC **D9/529**

(58) **Field of Classification Search**
USPC D3/201, 202; D9/414, 435, 499, 516,
D9/529, 530, 542, 543, 549, 574, 571, 575,
D9/688-691, 772, 773, 776; D28/4, 7, 9,
D28/73, 76, 85; 215/379, 381-385;
220/660, 669, 675
CPC B65D 3/00; B65D 3/04; B65D 35/22;
B65D 81/3227; B65D 81/3283
See application file for complete search history.

(56) **References Cited**

U.S. PATENT DOCUMENTS

D474,399 S * 5/2003 Cummings D9/729
D498,421 S * 11/2004 Kostow D9/529

D499,641 S * 12/2004 Cummings D9/729
D517,426 S * 3/2006 Shurtleff D9/529
D558,050 S * 12/2007 Urcun D9/529
D641,890 S * 7/2011 Nardo D24/224

* cited by examiner

Primary Examiner — Derrick Holland

Assistant Examiner — Janice Lim

(74) *Attorney, Agent, or Firm* — Manabu Kanesaka

(57) **CLAIM**

The ornamental design for a bottle, as shown and described.

DESCRIPTION

FIG. 1 is a perspective view of a bottle showing my new design;
FIG. 2 is a front view thereof;
FIG. 3 is a rear view thereof;
FIG. 4 is a right side view thereof, and a left side view being a mirror image thereof;
FIG. 5 is a top plan view thereof;
FIG. 6 is a bottom plan view thereof; and,
FIG. 7 is another perspective view thereof, shown without the lid for ease of illustration.
The broken line portions of FIG. 7 are included to show unclaimed subject matter only and form no part of claimed design.

1 Claim, 4 Drawing Sheets

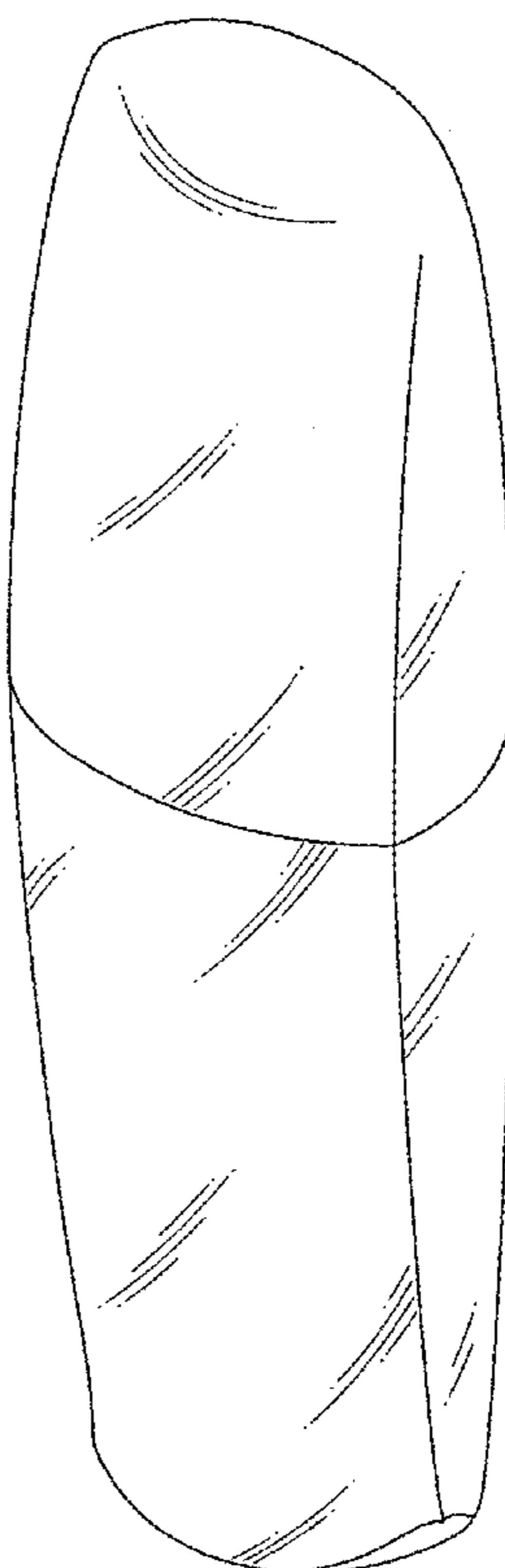

Fig. 1

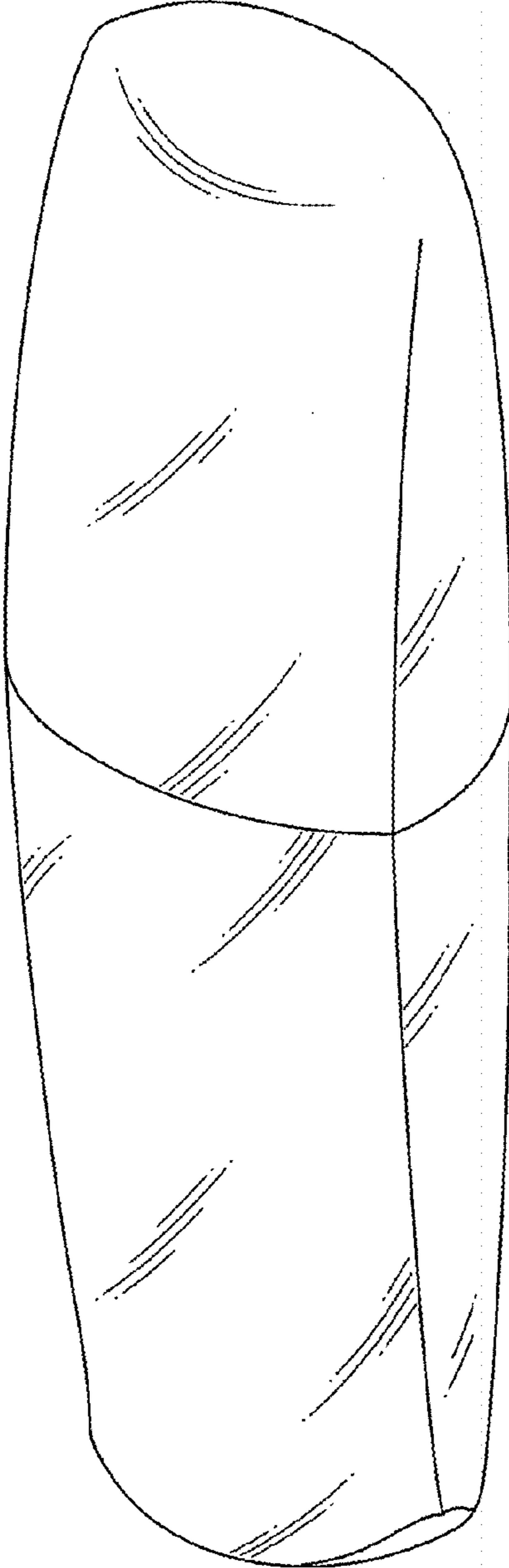

Fig. 2

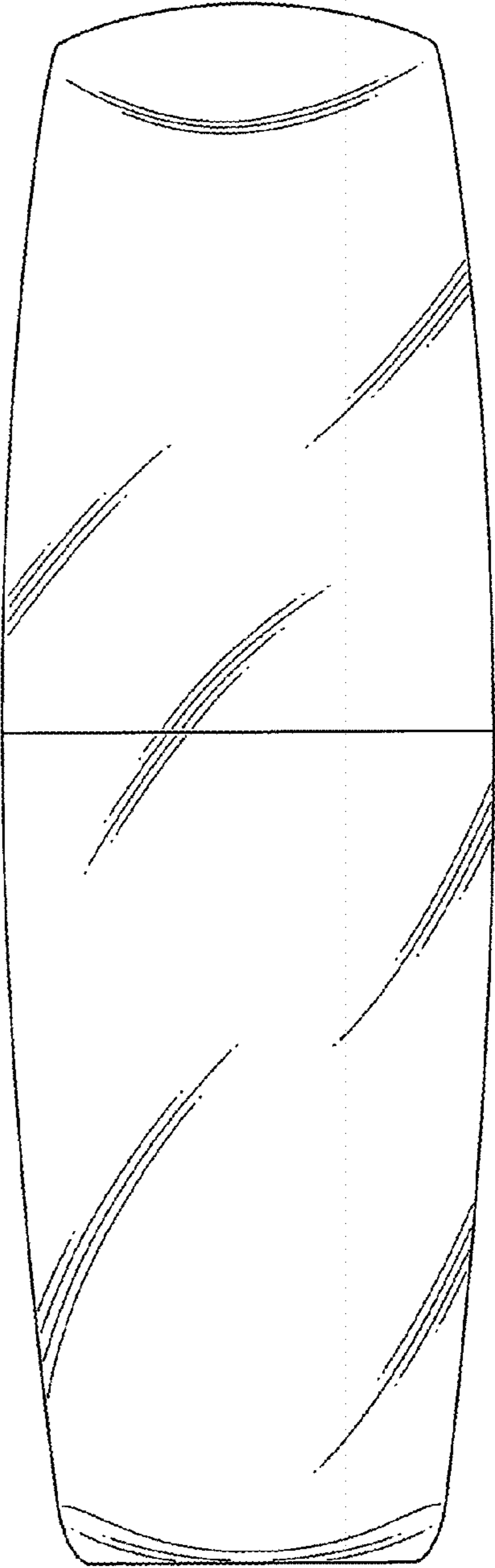

Fig. 3

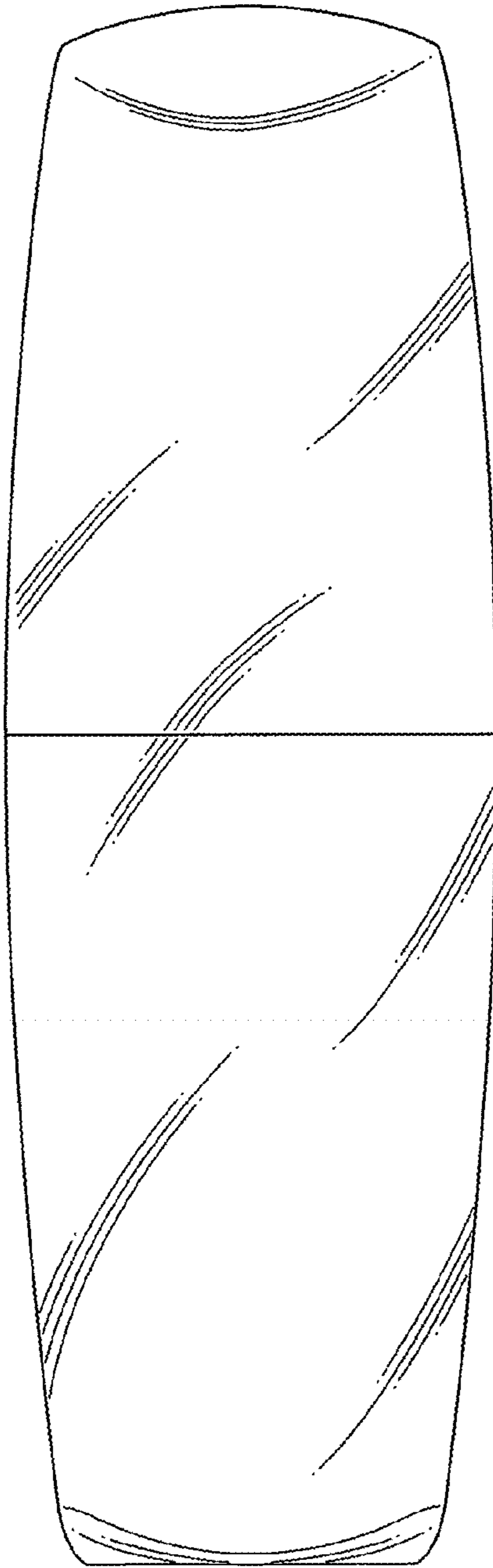

Fig. 4

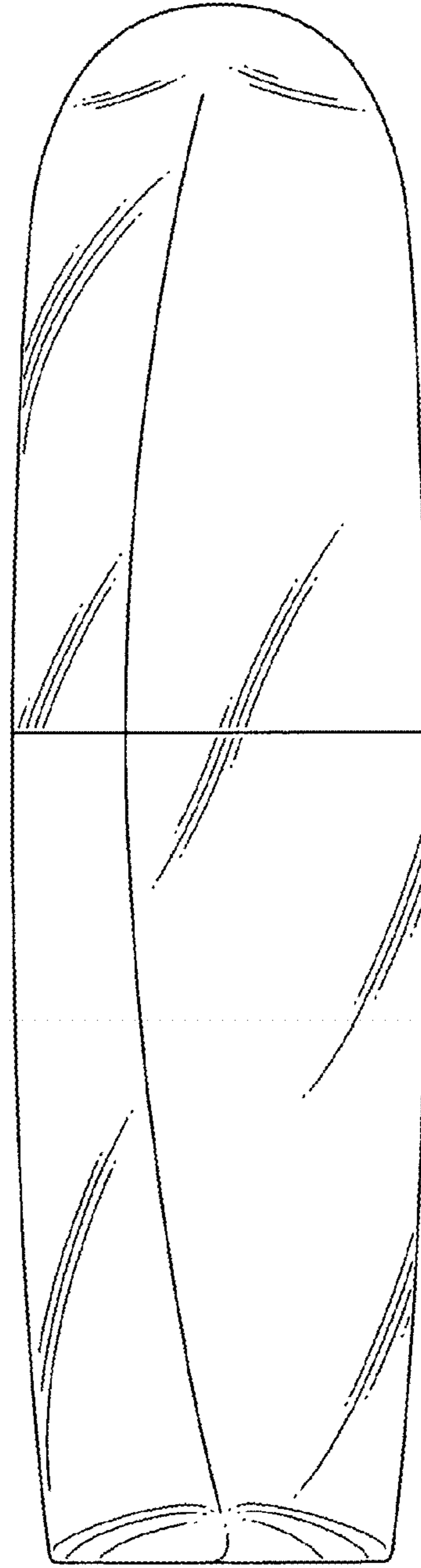

Fig. 5

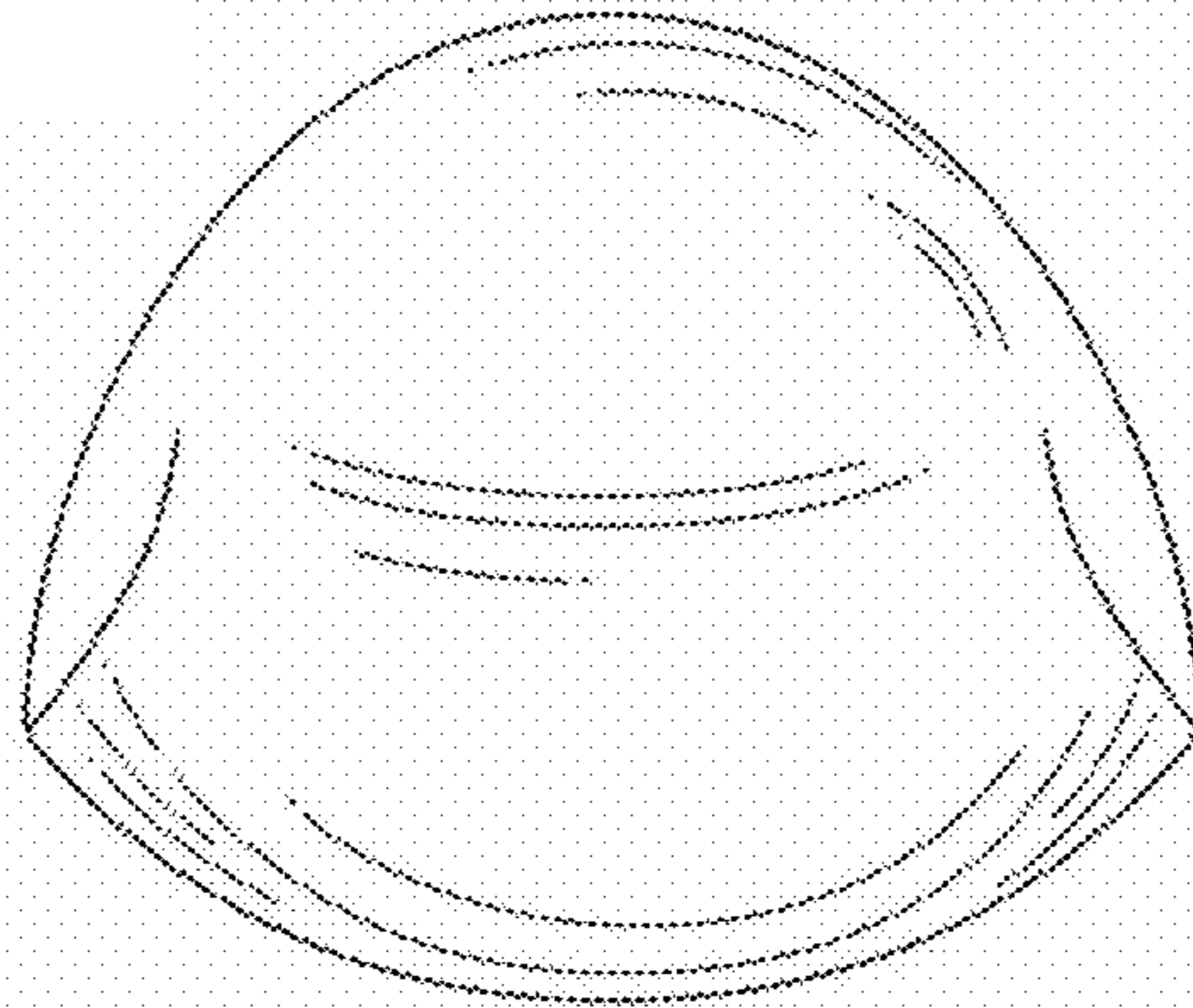

Fig. 6

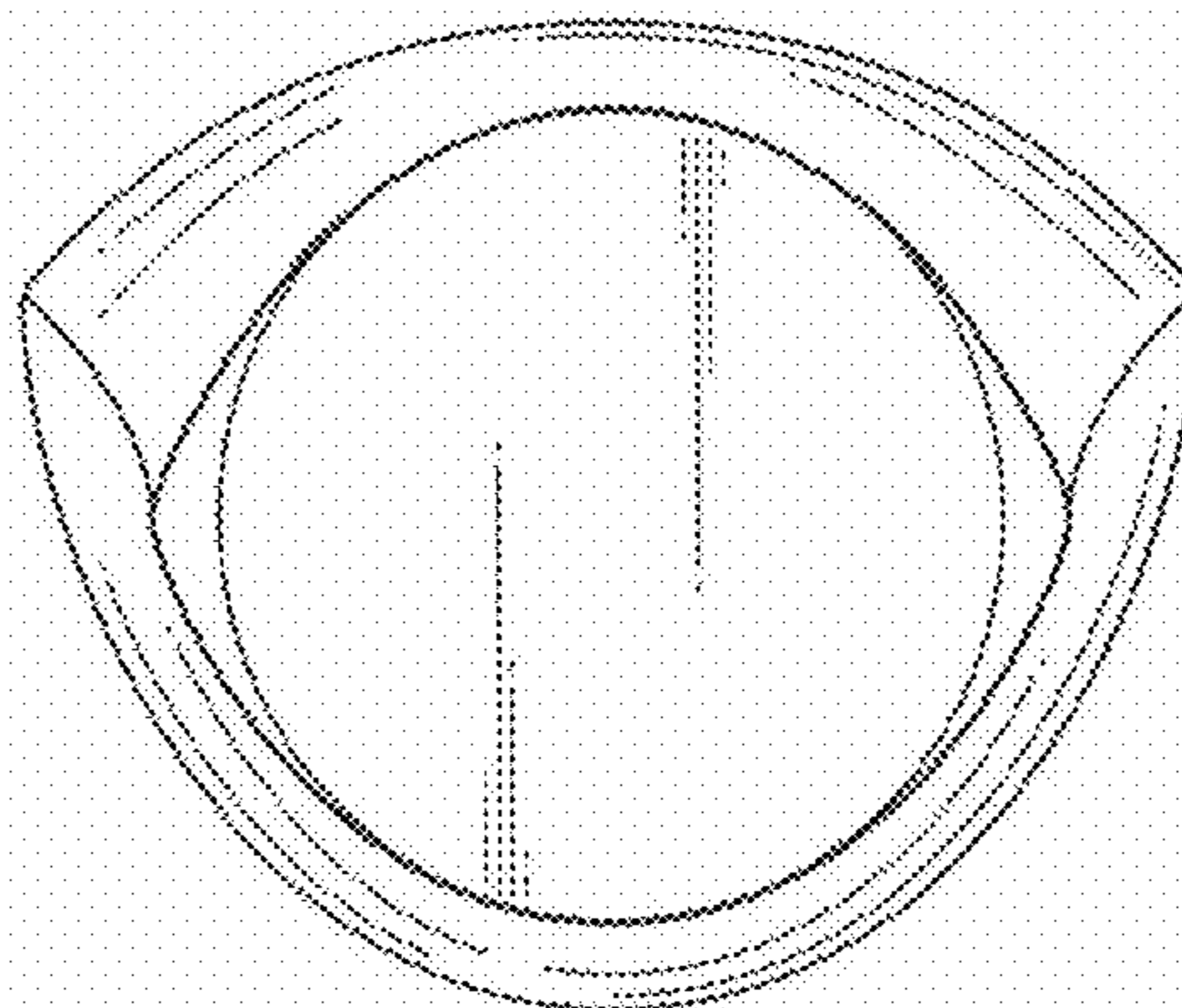

Fig. 7

