



US00D755044S

(12) **United States Design Patent**
Nettenstrom et al.

(10) **Patent No.:** **US D755,044 S**
(45) **Date of Patent:** **** May 3, 2016**

- (54) **PACKAGE**
- (71) Applicant: **Nicoventures Holdings Limited**,
London (GB)
- (72) Inventors: **Matthew Nettenstrom**, Oakbrook
Terrace, IL (US); **Tom McKeon**,
Oakbrook Terrace, IL (US); **Justin
Peart**, Oakbrook Terrace, IL (US)
- (73) Assignee: **NICOVENTURES HOLDINGS
LIMITED**, London (GB)
- (**) Term: **15 Years**
- (21) Appl. No.: **29/530,299**
- (22) Filed: **Jun. 15, 2015**

Related U.S. Application Data

- (62) Division of application No. 29/487,789, filed on Apr.
11, 2014, now Pat. No. Des. 738,716.

Foreign Application Priority Data

- Oct. 14, 2013 (EM) 001387104
- (51) **LOC (10) Cl.** **09-03**
- (52) **U.S. Cl.**
USPC **D9/418**
- (58) **Field of Classification Search**
USPC D9/418, 414, 421, 434, 423, 415, 721,
D9/432; D7/538; D27/189; 206/769, 303,
206/765, 777, 574, 783; 229/162.7, 162.3
CPC B65D 5/4204; B65D 5/5007; B65D 85/02;
A47F 7/03; A41H 3/08
See application file for complete search history.

References Cited

U.S. PATENT DOCUMENTS

- 2,034,809 A * 3/1936 Grant B65D 5/18
206/303
- 2,464,951 A * 3/1949 Stengren B65D 5/5007
206/45.29

- 2,700,456 A * 1/1955 Gillam B65D 5/5038
206/485
- 3,033,357 A * 5/1962 Vogel A41H 3/08
206/574
- 3,207,411 A * 9/1965 Farquhar B65D 5/3621
206/457
- 3,680,687 A * 8/1972 D'Alessio B65D 5/5016
206/783
- 4,109,786 A * 8/1978 Roccaforte B65D 5/5038
206/783
- 5,271,552 A * 12/1993 McDonnell B65D 5/4204
229/162.7
- D405,007 S * 2/1999 Naas, Sr. D27/189
- D557,135 S * 12/2007 Demalsche D9/418
- D563,218 S * 3/2008 DeMalsche D9/418
- D579,325 S * 10/2008 Bray D9/423
- D590,249 S * 4/2009 Yanchev D9/421
- D600,110 S * 9/2009 Cain D9/418
- D600,547 S * 9/2009 Cain D9/418
- D601,747 S * 10/2009 Tabrah D27/189
- D630,503 S * 1/2011 Abdalkhani D9/418
- D636,663 S * 4/2011 Work D9/418
- D638,291 S * 5/2011 England D9/432
- D652,321 S * 1/2012 Melnick D9/721
- D668,540 S * 10/2012 Lutzig D9/432
- D678,057 S * 3/2013 Holford D9/423
- D679,950 S * 4/2013 Cooper D7/538

(Continued)

Primary Examiner — Holly Baynham

Assistant Examiner — Rhea Shields

(74) *Attorney, Agent, or Firm* — Patterson Thunte
Pedersen, P.A.

(57) **CLAIM**

The ornamental design for a package, as shown and
described.

DESCRIPTION

FIG. 1 is a perspective view of the new design for a package;
FIG. 2 is a front view thereof;
FIG. 3 is a back view thereof;
FIG. 4 is a right-side view thereof;
FIG. 5 is a left-side view thereof;
FIG. 6 is a top view thereof; and,
FIG. 7 is a bottom view thereof.

1 Claim, 7 Drawing Sheets

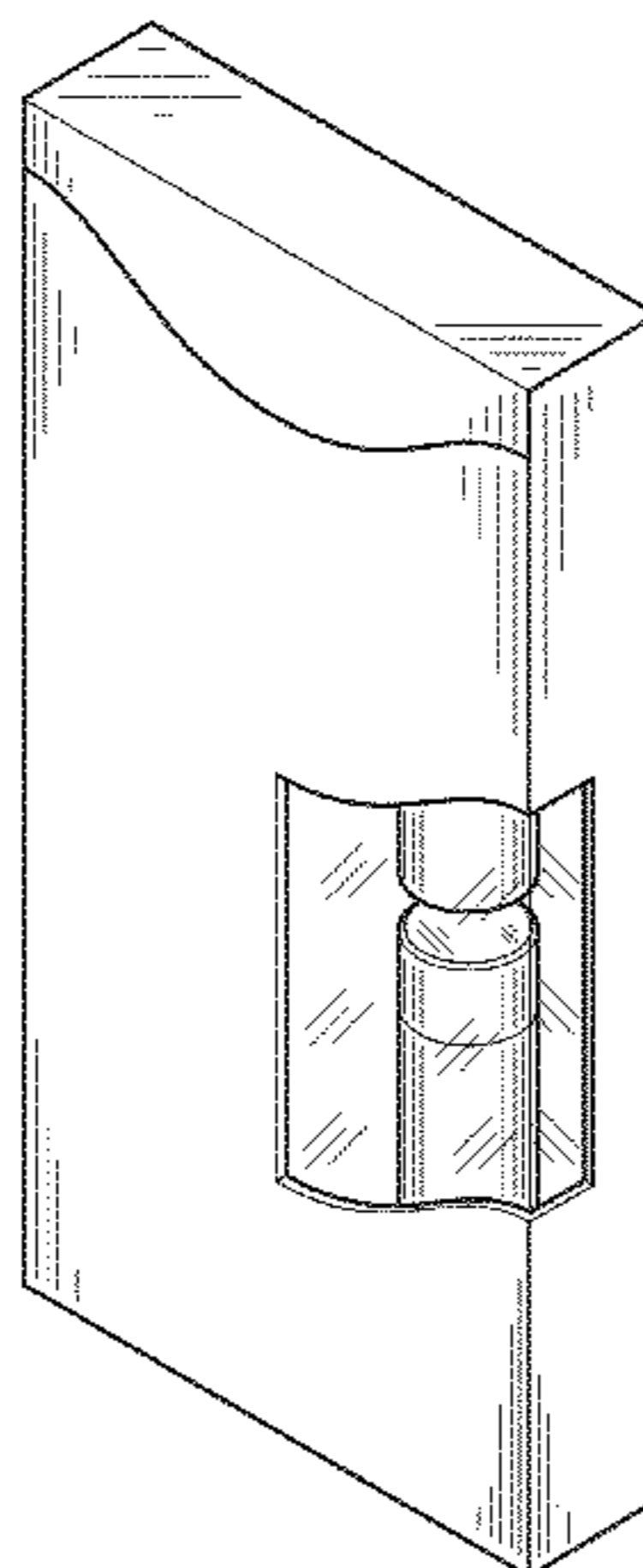

(56)

References Cited

U.S. PATENT DOCUMENTS

D681,445 S	5/2013	van Landsveld et al.	
D691,464 S	10/2013	Lee et al.	
D695,605 S *	12/2013	Johnson	D9/423
D699,103 S *	2/2014	Rathbone	D9/418
			* cited by examiner
D702,546 S *	4/2014	McAdam	D9/418
D704,049 S *	5/2014	Ridenour	D9/418
D710,713 S *	8/2014	Fath	D9/721
D738,716 S *	9/2015	Nettenstrom	D9/418
2012/0061290 A1 *	3/2012	Delahunay	B65D 5/5019 206/769

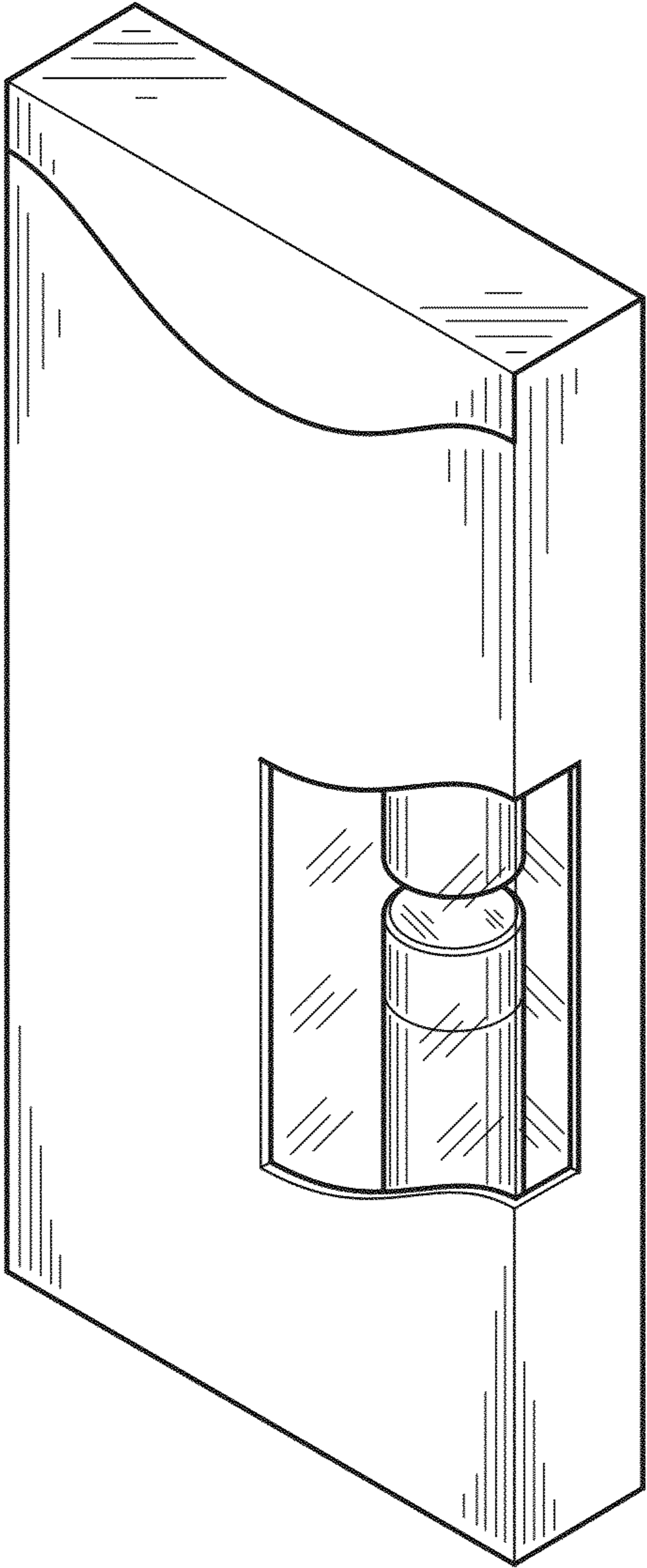

FIG. 1

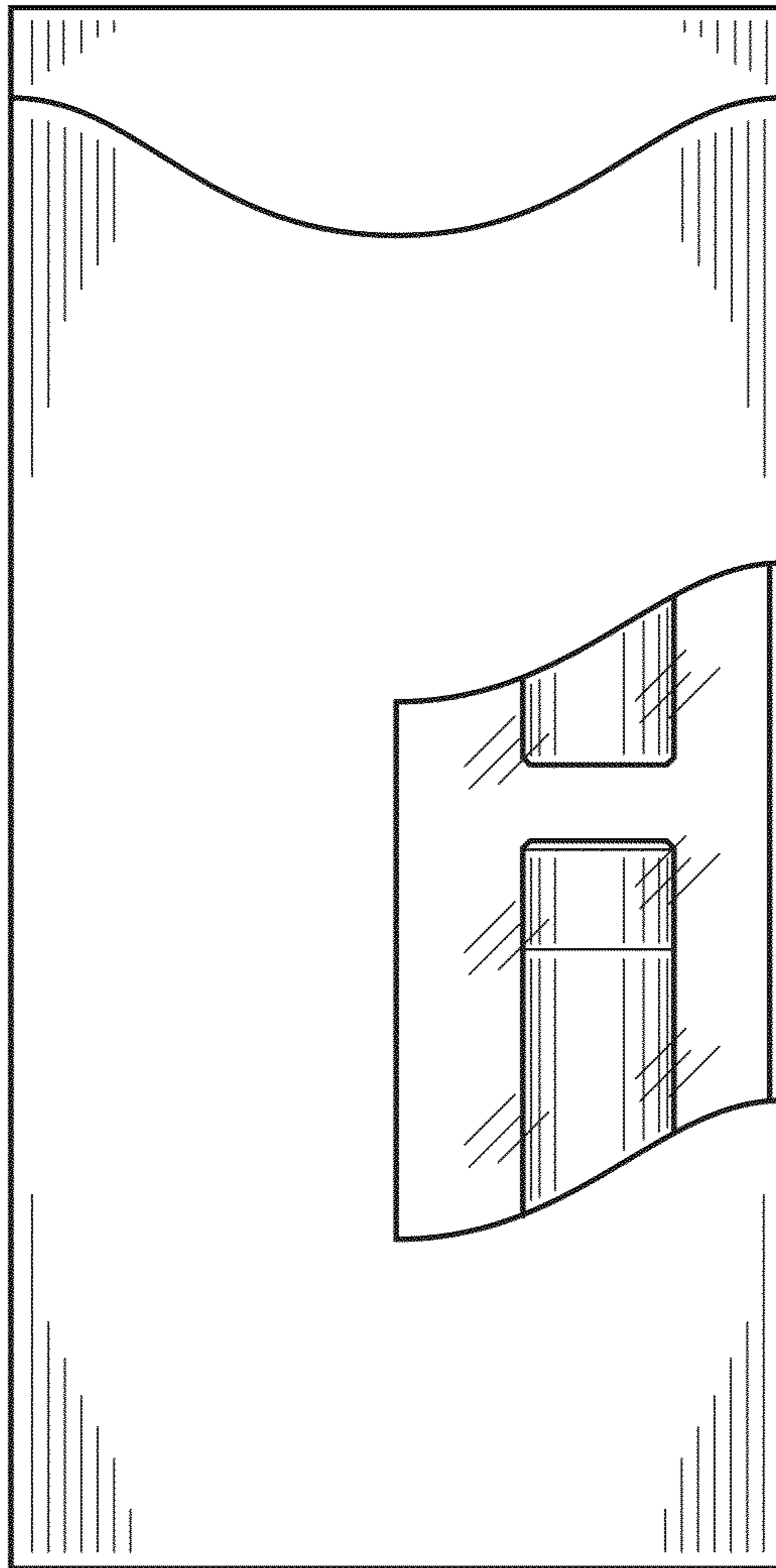

FIG. 2

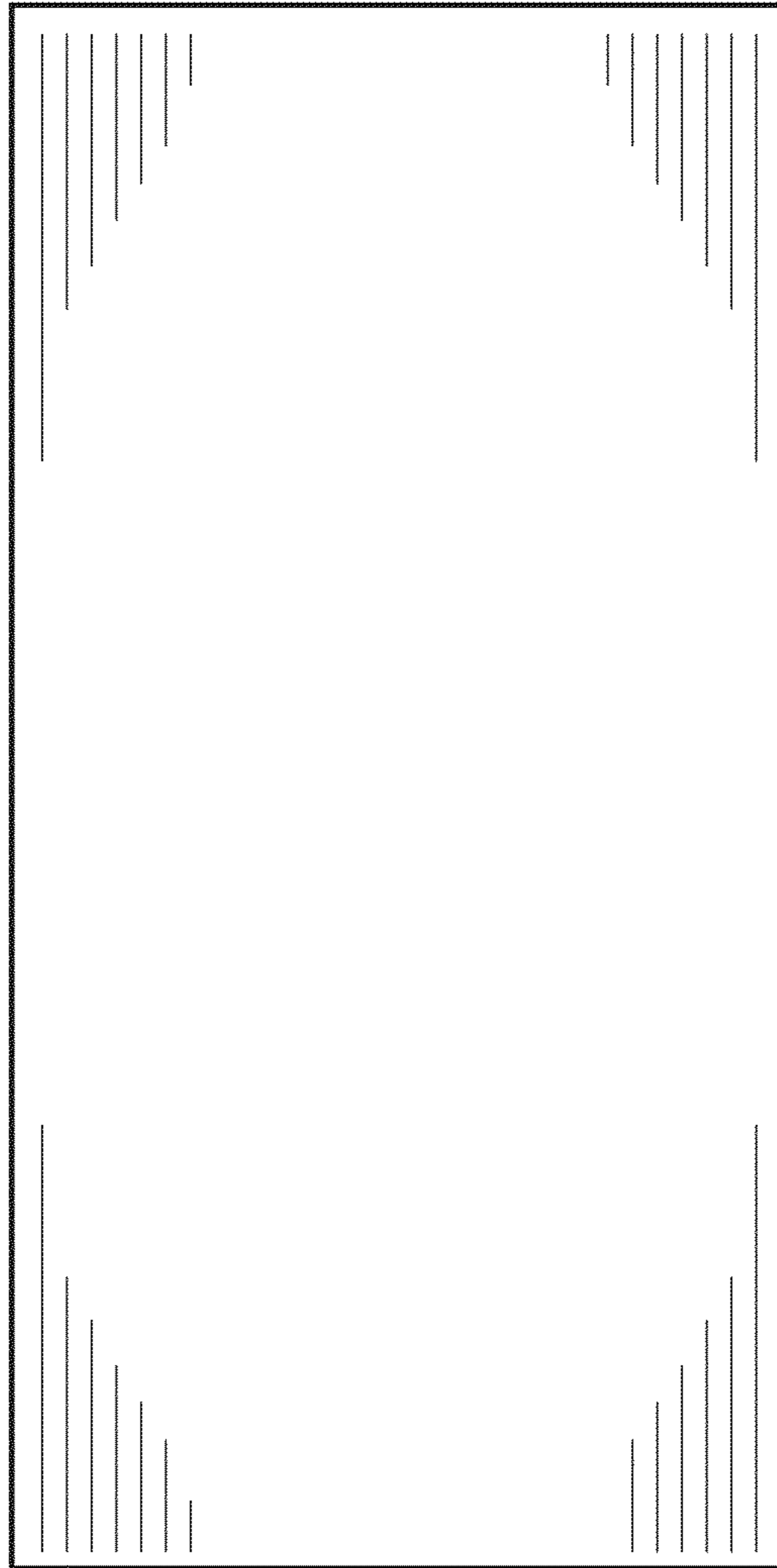

FIG. 3

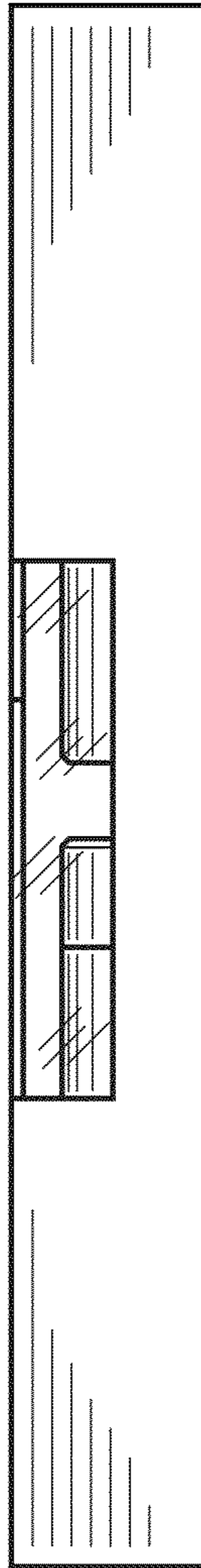

FIG. 4

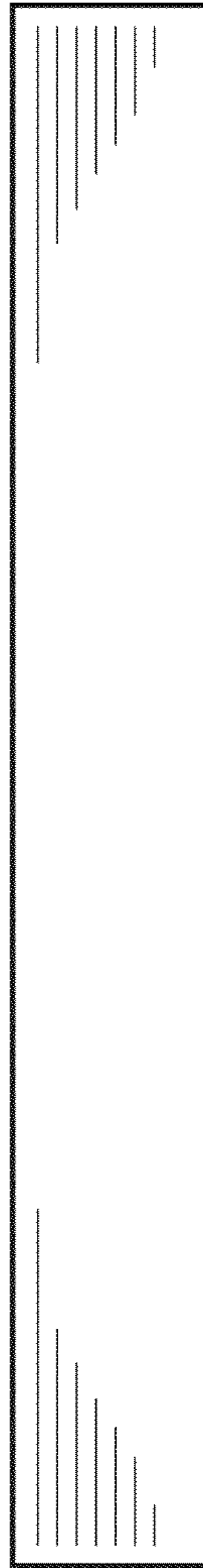

FIG. 5

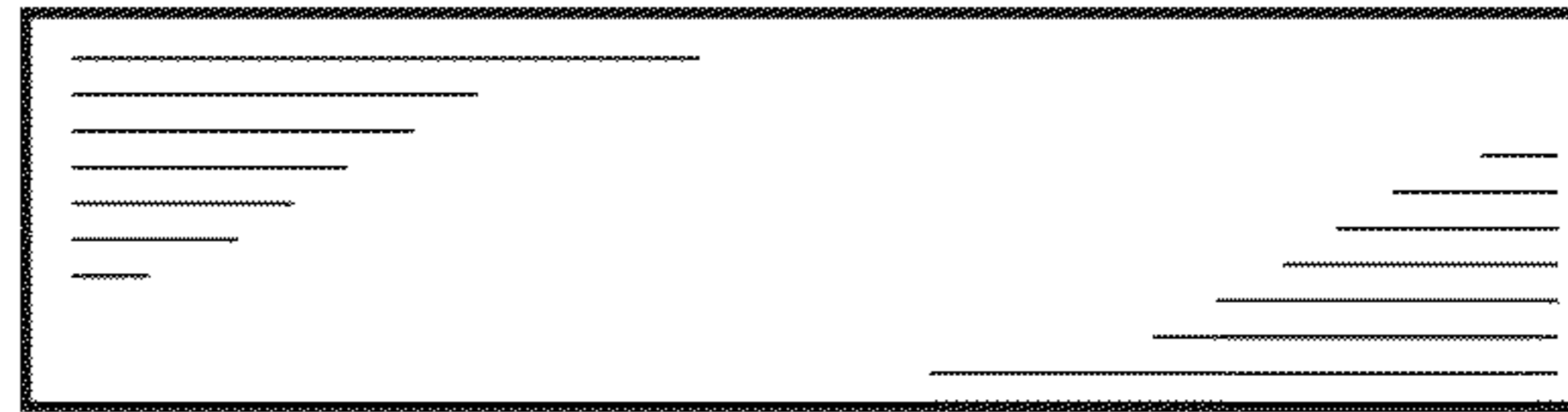

FIG. 6

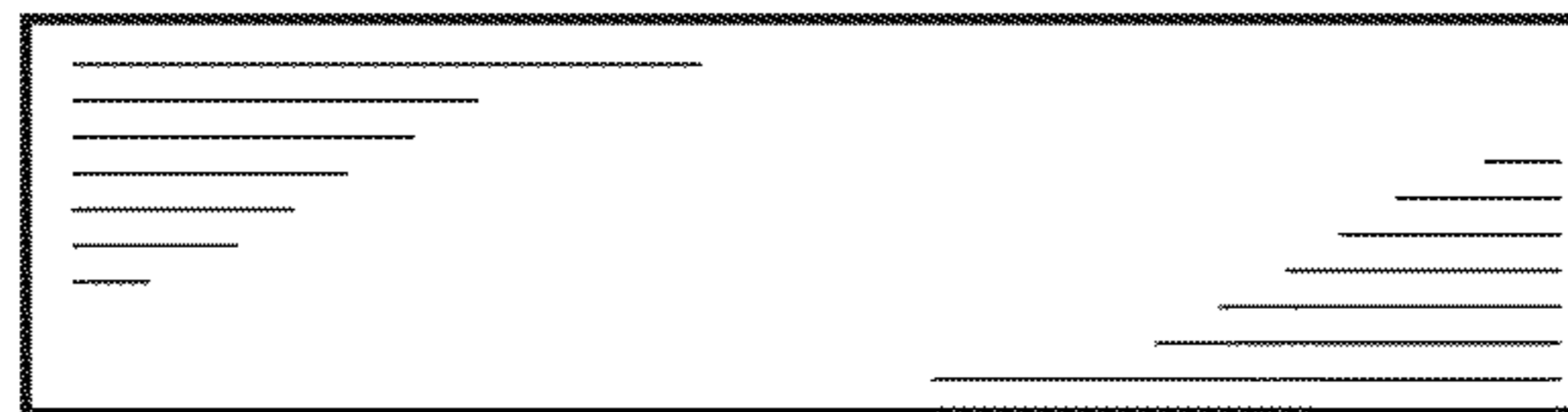

FIG. 7