



US00D755022S

(12) **United States Design Patent**
Dukat

(10) **Patent No.:** **US D755,022 S**
(45) **Date of Patent:** **** May 3, 2016**

(54) **HERB GRINDING DEVICE**

(71) Applicant: **Dane Joseph Dukat**, Mesa, AZ (US)

(72) Inventor: **Dane Joseph Dukat**, Mesa, AZ (US)

(**) Term: **14 Years**

(21) Appl. No.: **29/511,180**

(22) Filed: **Dec. 8, 2014**

(51) **LOC (10) Cl.** **07-04**

(52) **U.S. Cl.**
USPC **D7/679; D7/372**

(58) **Field of Classification Search**
USPC D7/679, 590-598, 372-374, 401.1, 383, D7/384
CPC A47J 42/08; A47J 4/238; A47J 42/04; A47J 42/46; A47J 42/14; A47J 42/34; A47J 42/40; B02C 18/16; B02C 18/08
See application file for complete search history.

(56) **References Cited**

U.S. PATENT DOCUMENTS

795,746 A * 7/1905 Wingfield et al. A24F 15/18 131/311
D474,378 S * 5/2003 Brandenburg D7/679

(Continued)

Primary Examiner — Terry Wallace

(74) *Attorney, Agent, or Firm* — Weiss & Moy, P.C.; Jeffrey D. Moy

(57) **CLAIM**

The ornamental design for the herb grinding device, as shown and described.

DESCRIPTION

FIG. 1 is an exploded top perspective view of a first embodiment of the design of the herb grinding device;
FIG. 2 is an exploded bottom perspective view thereof;
FIG. 3 is an exploded left side view thereof;

FIG. 4 is an exploded front side view thereof;
FIG. 5 is an exploded right side view thereof;
FIG. 6 is an exploded rear side view thereof;
FIG. 7 is a top view thereof, the opposite, bottom being identical to the top;
FIG. 8 is a top view of the bottom section thereof;
FIG. 9 is a bottom view of the top section thereof;
FIG. 10 is a bottom view of the second section thereof;
FIG. 11 is a top view of the second section thereof;
FIG. 12 is a bottom view of the third section thereof;
FIG. 13 is a top view of the third section thereof;
FIG. 14 is an exploded top perspective view of a second embodiment of the design of the herb grinding device;
FIG. 15 is an exploded bottom perspective view thereof;
FIG. 16 is an exploded front side view thereof;
FIG. 17 is an exploded right side view thereof;
FIG. 18 is an exploded rear side view thereof;
FIG. 19 is an exploded left side view thereof;
FIG. 20 is a top view thereof, the opposite, bottom being identical to the top;
FIG. 21 is a top view of the bottom section thereof;
FIG. 22 is a bottom view of the top section thereof;
FIG. 23 is a bottom view of the second section thereof;
FIG. 24 is a top view of the second section thereof;
FIG. 25 is a bottom view of the third section thereof;
FIG. 26 is a top view of the third section thereof;
FIG. 27 is an exploded top perspective view of a third embodiment of the design of the herb grinding device;
FIG. 28 is an exploded bottom perspective view thereof;
FIG. 29 is an exploded front side view thereof;
FIG. 30 is an exploded left side view thereof;
FIG. 31 is an exploded rear side view thereof;
FIG. 32 is an exploded right side view thereof;
FIG. 33 is a top view thereof, the opposite, bottom being identical to the top;
FIG. 34 is a top view of the bottom section thereof;
FIG. 35 is a bottom view of the top section thereof;
FIG. 36 is a bottom view of the second section thereof;
FIG. 37 is a top view of the second section thereof;
FIG. 38 is a bottom view of the third section thereof; and,
FIG. 39 is a top view of the third section thereof.
The sections are shown separately for clarity and ease of illustration.
The broken lines in the drawings illustrate features that form no part of the claimed design.

1 Claim, 15 Drawing Sheets

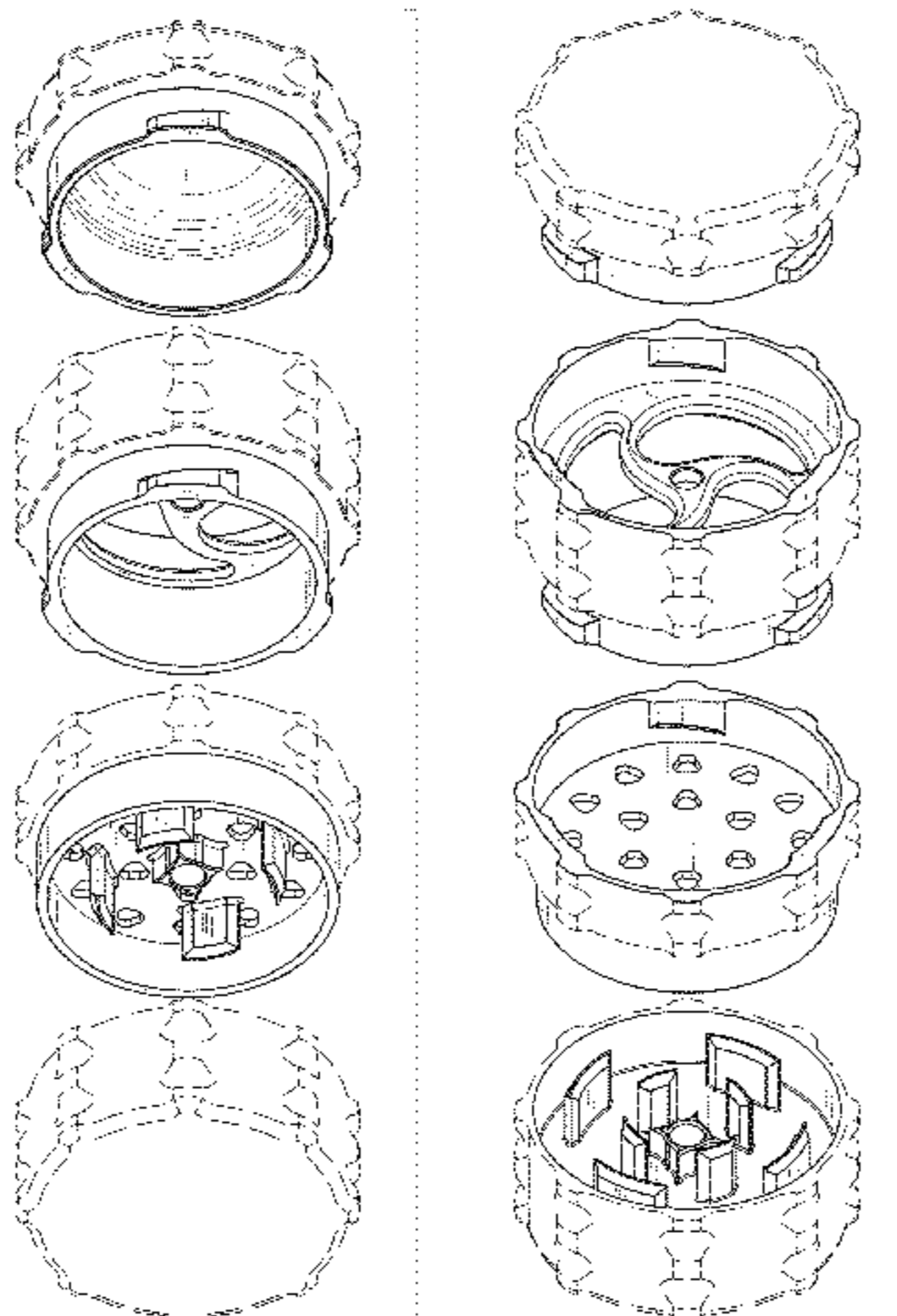

(56)

References Cited

U.S. PATENT DOCUMENTS

6,945,486	B2 *	9/2005	Teng	A47J 19/06 241/169.1
7,367,519	B2 *	5/2008	de Groote	A47J 19/04 241/168
7,422,170	B2 *	9/2008	Bao	B02C 18/24 241/168
8,220,732	B2 *	7/2012	Griffin	A47J 43/04 241/169.1
8,393,563	B2 *	3/2013	Chaoui	G02C 18/08 241/168

D714,595	S	10/2014	Ducey		
2009/0256016	A1 *	10/2009	Lauzet	A47J 42/18 241/169.1
2012/0097774	A1 *	4/2012	Hainbach	A47J 42/14 241/101.2
2012/0286081	A1 *	11/2012	Delbridge	A47J 42/14 241/169.1
2013/0015278	A1 *	1/2013	Edwards	A47J 42/40 241/69
2013/0214068	A1 *	8/2013	Camitta	B02C 18/16 241/25
2013/0277473	A1 *	10/2013	Delbridge	A47J 42/38 241/169.1

* cited by examiner

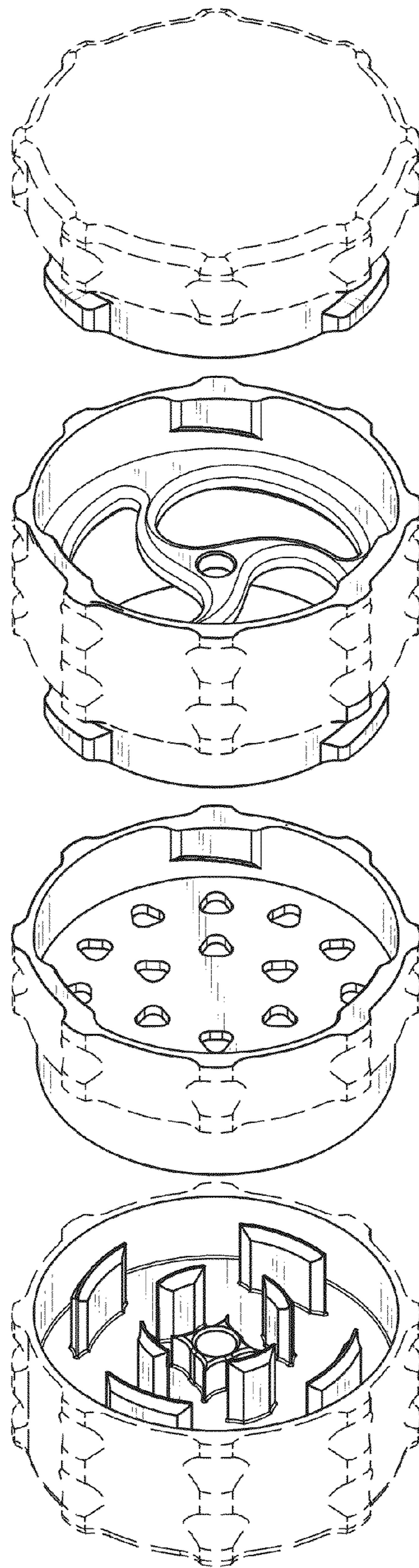
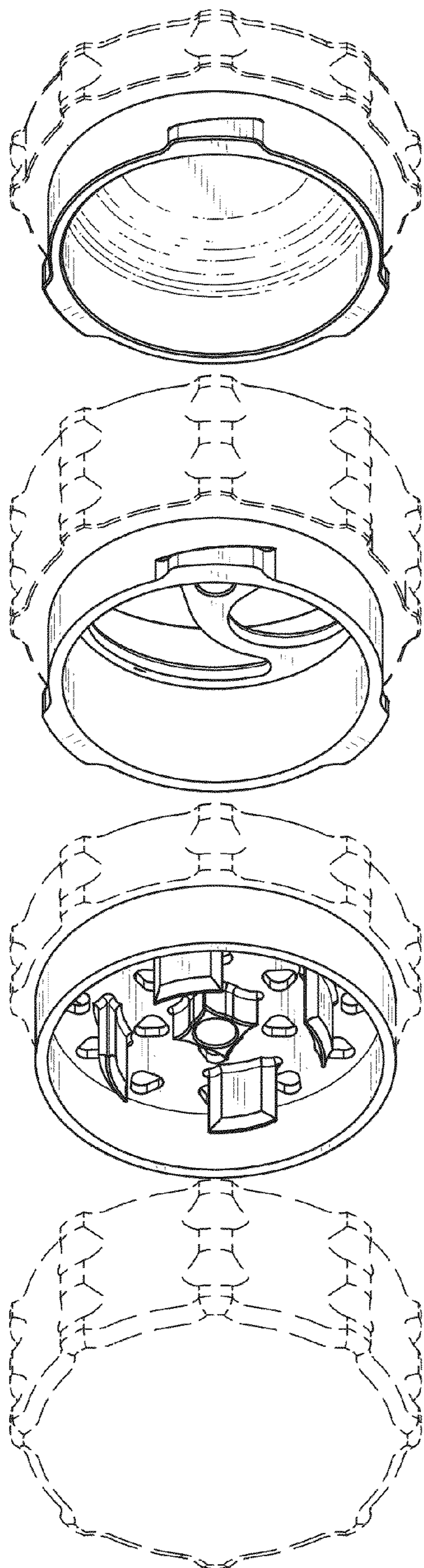

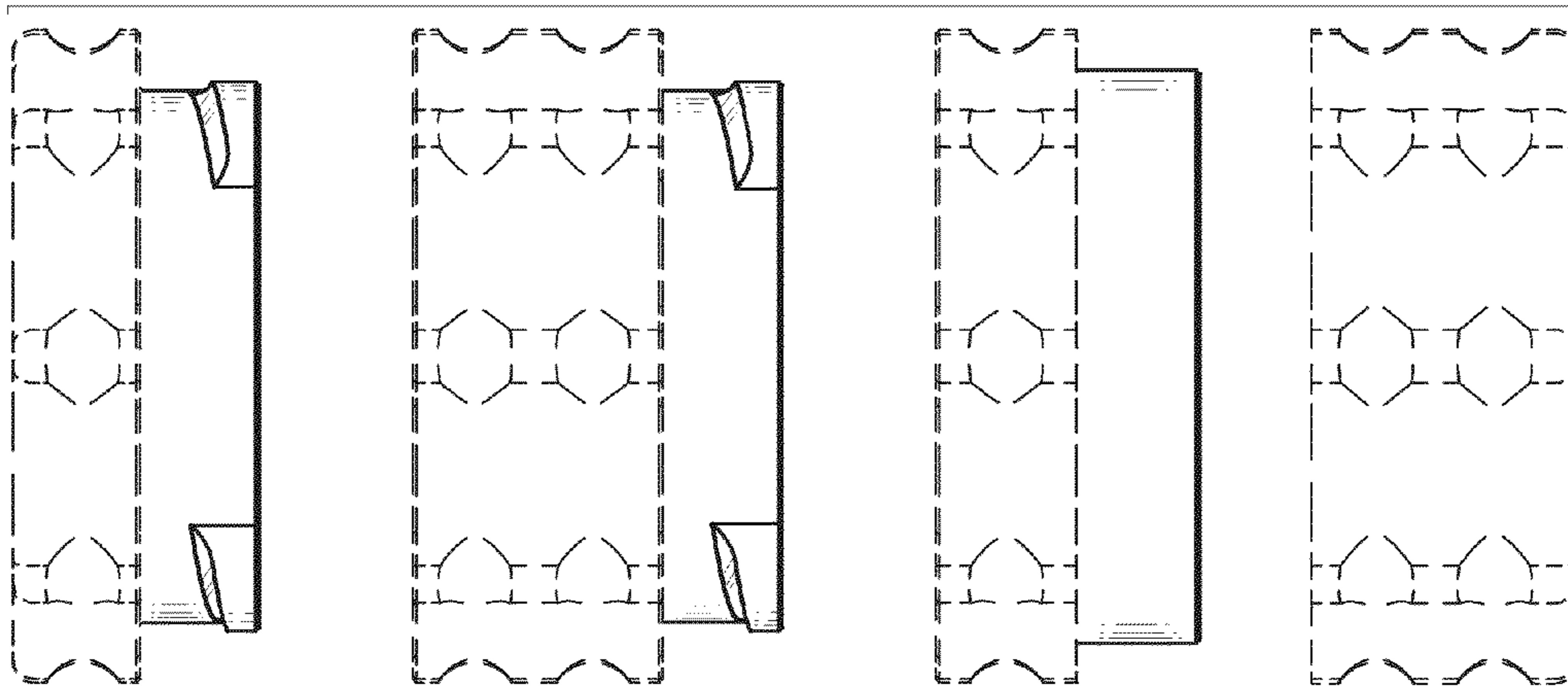

FIG. 5

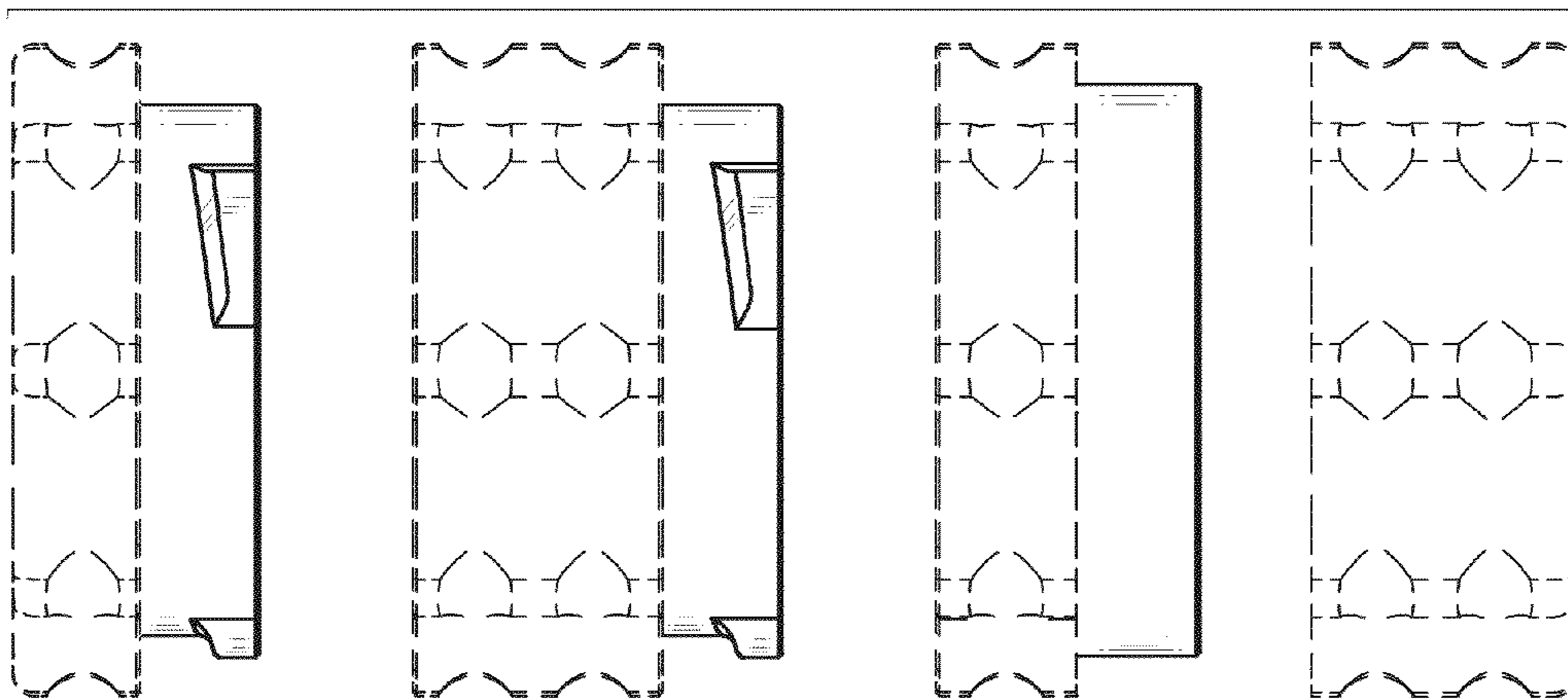

FIG. 4

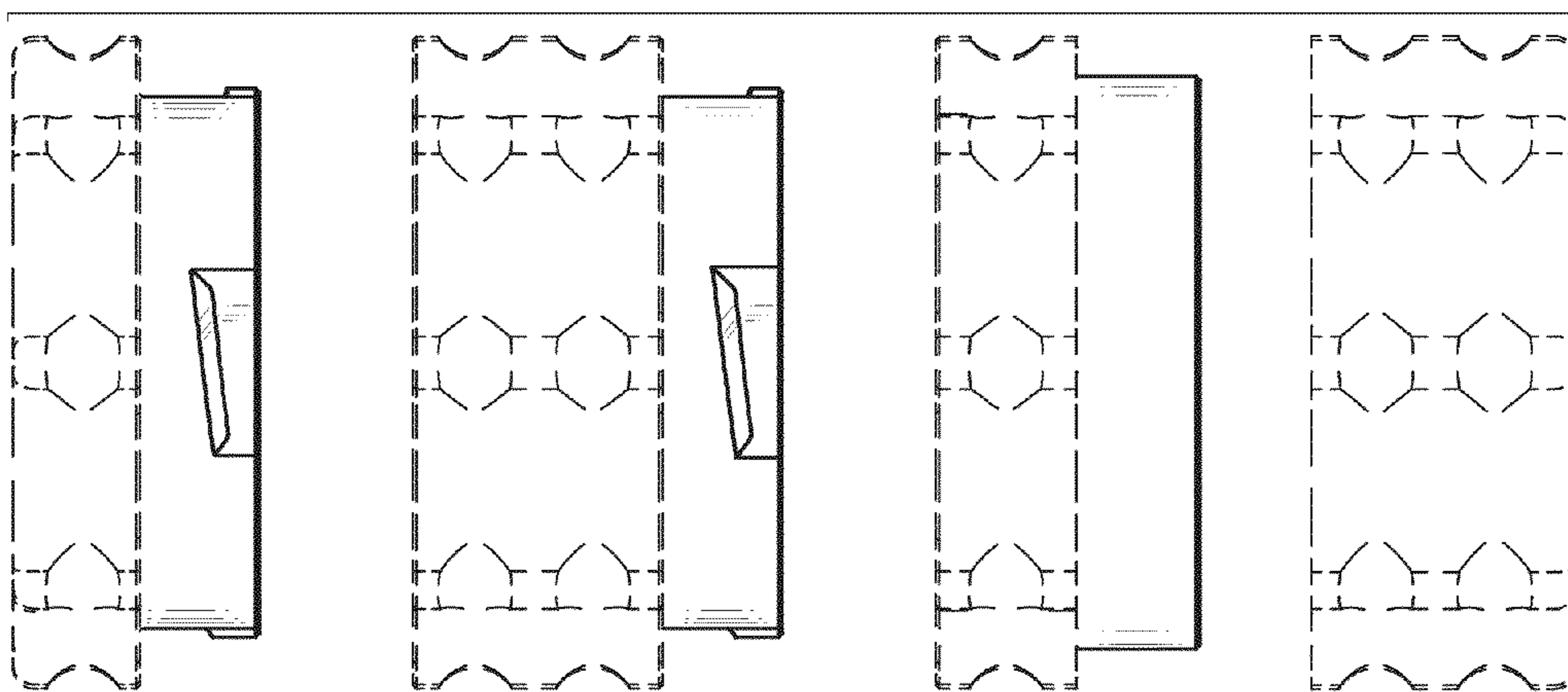

FIG. 3

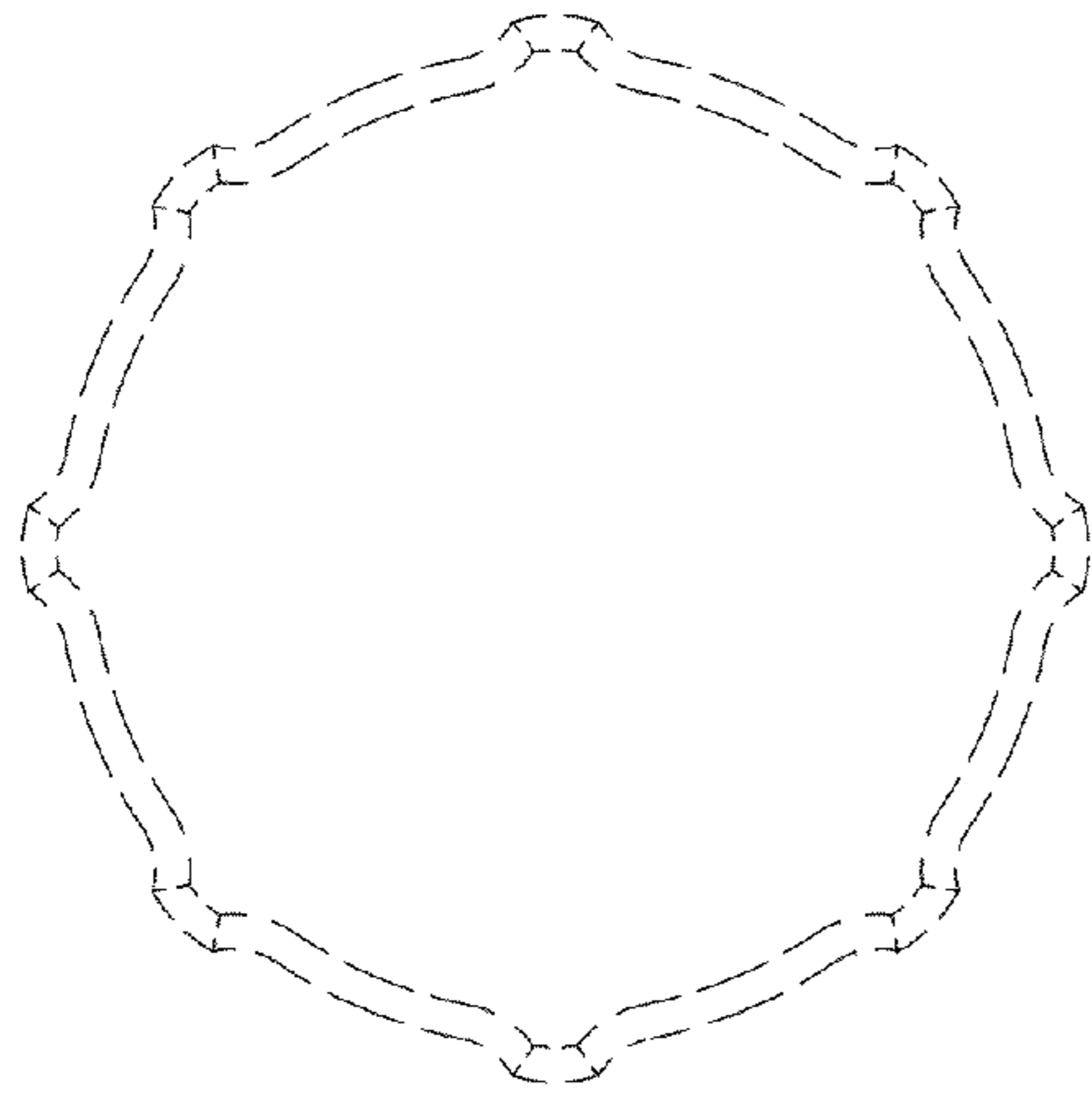

FIG. 7

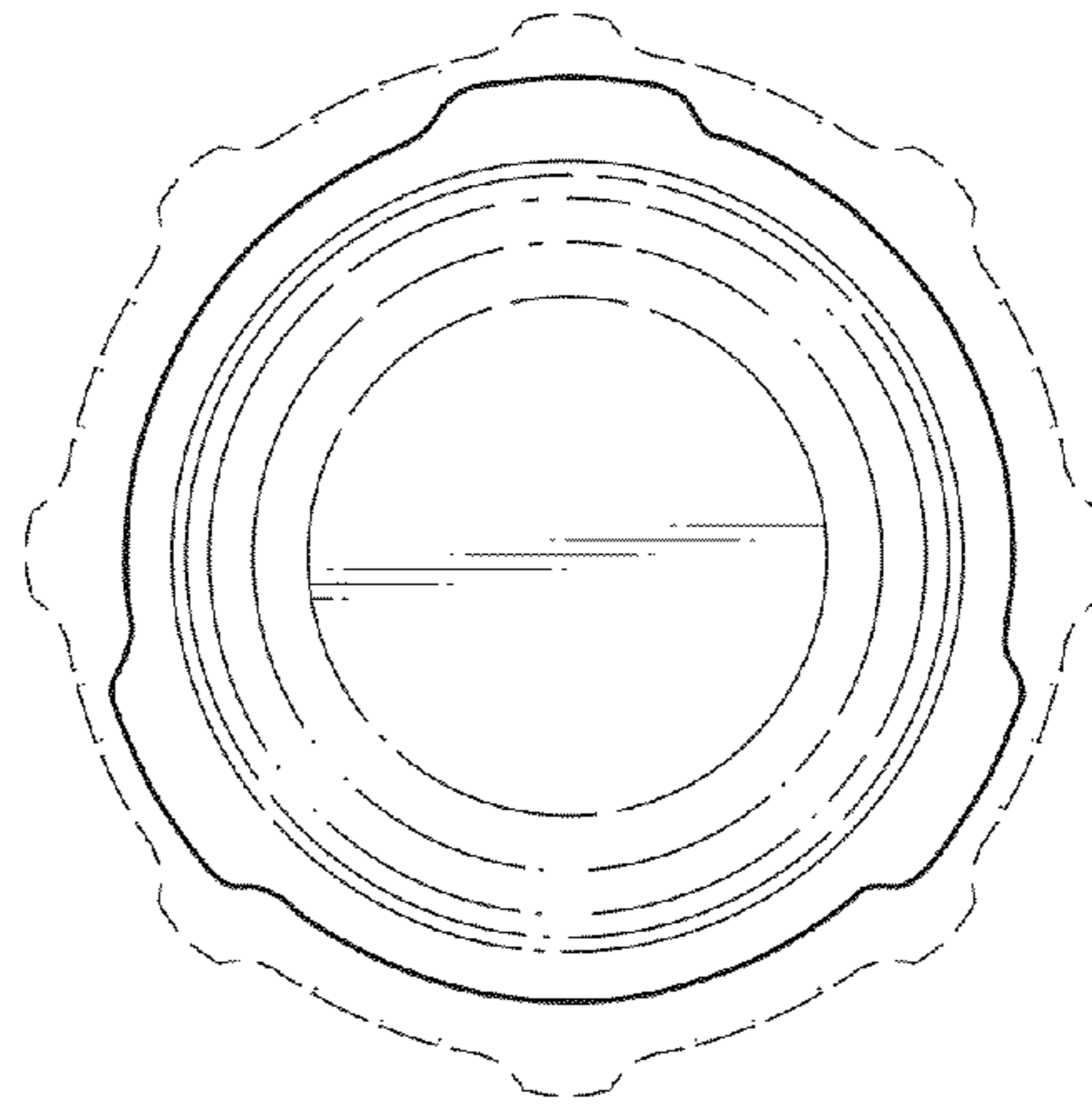

FIG. 8

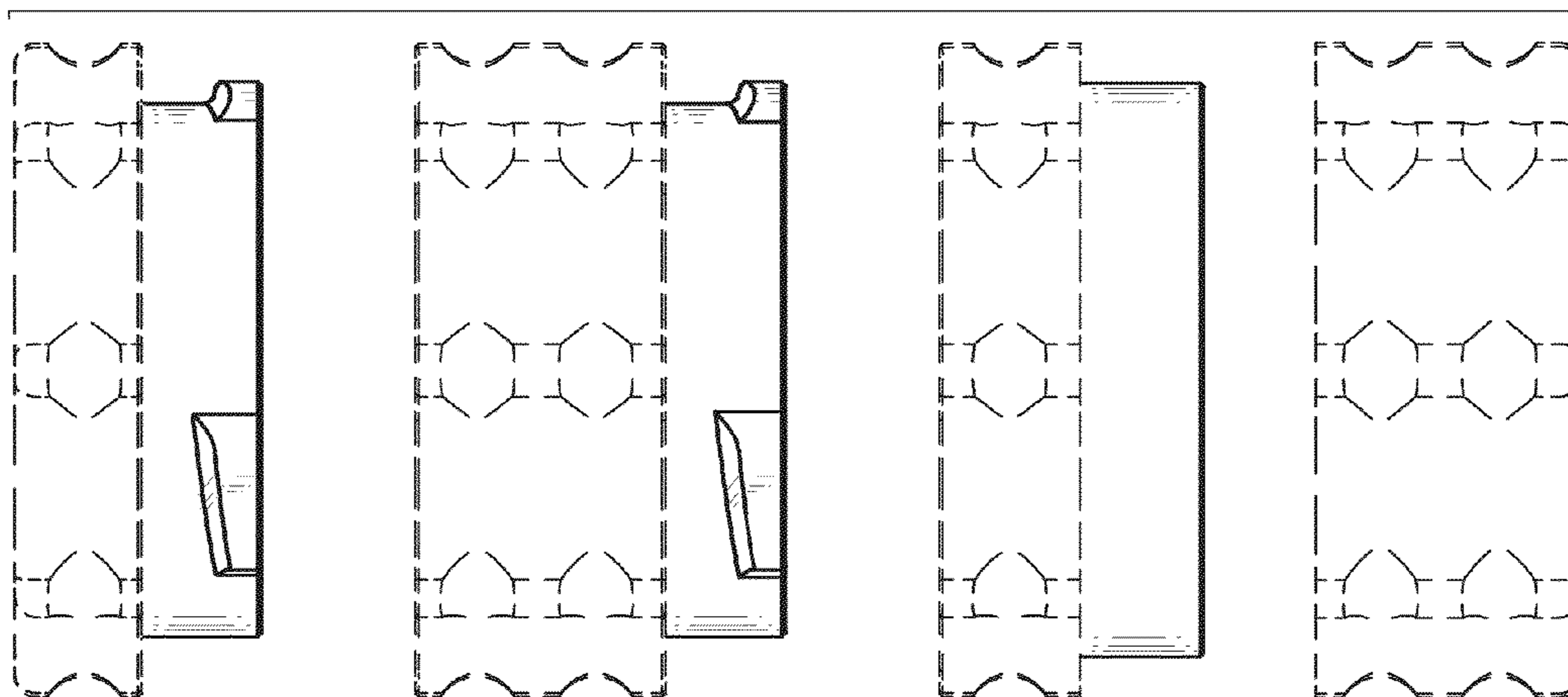

FIG. 6

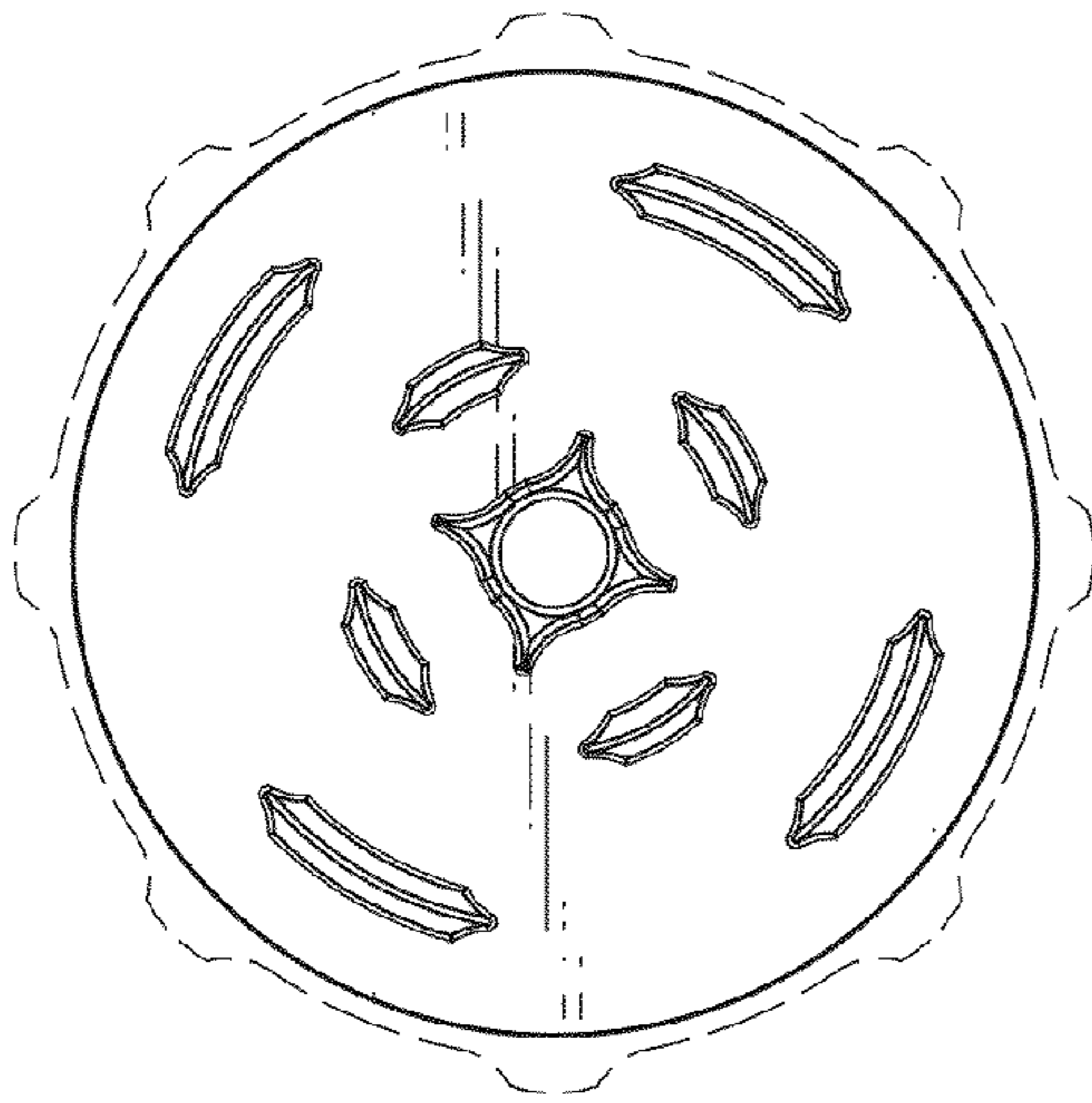

FIG. 9

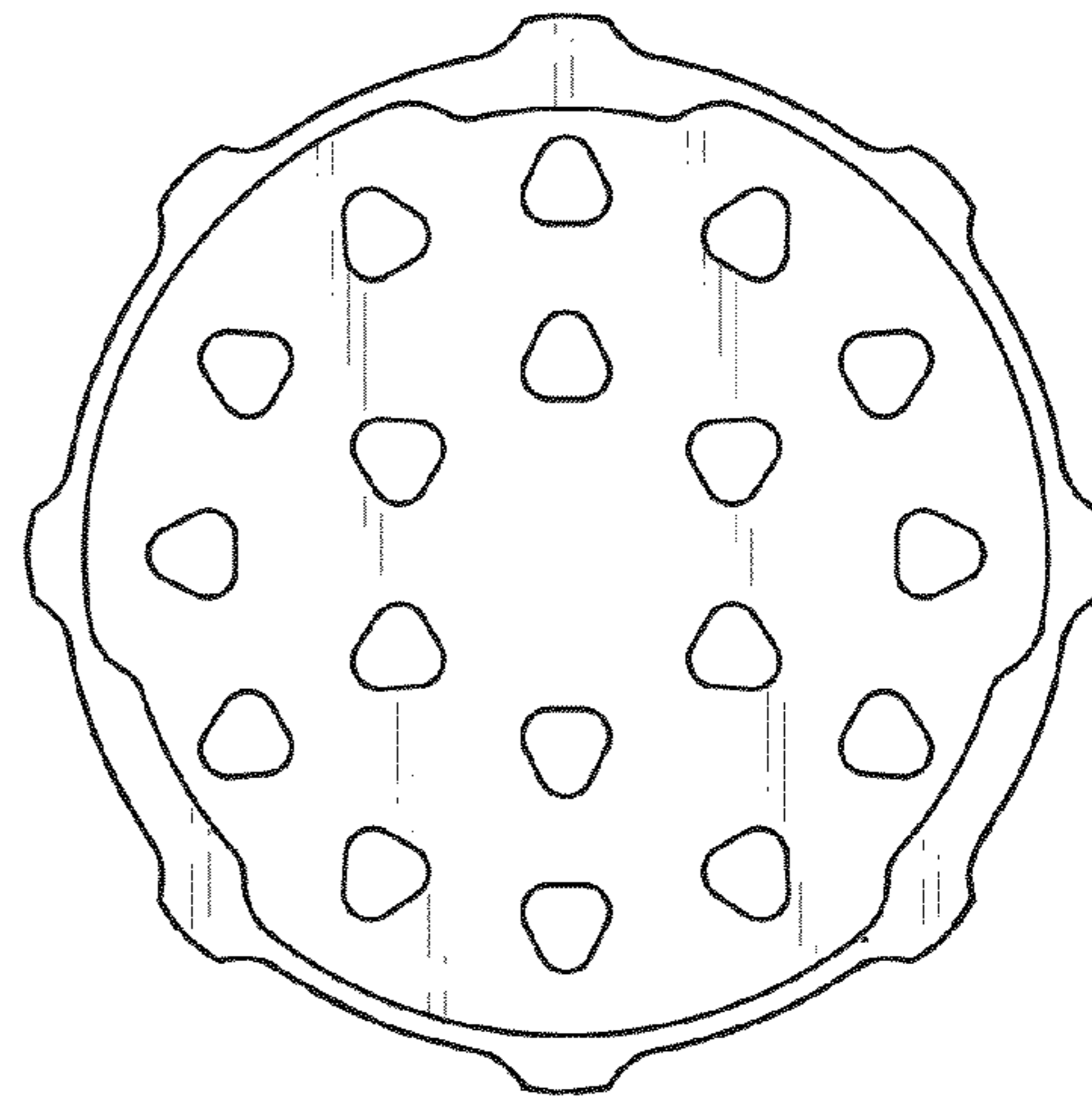

FIG. 10

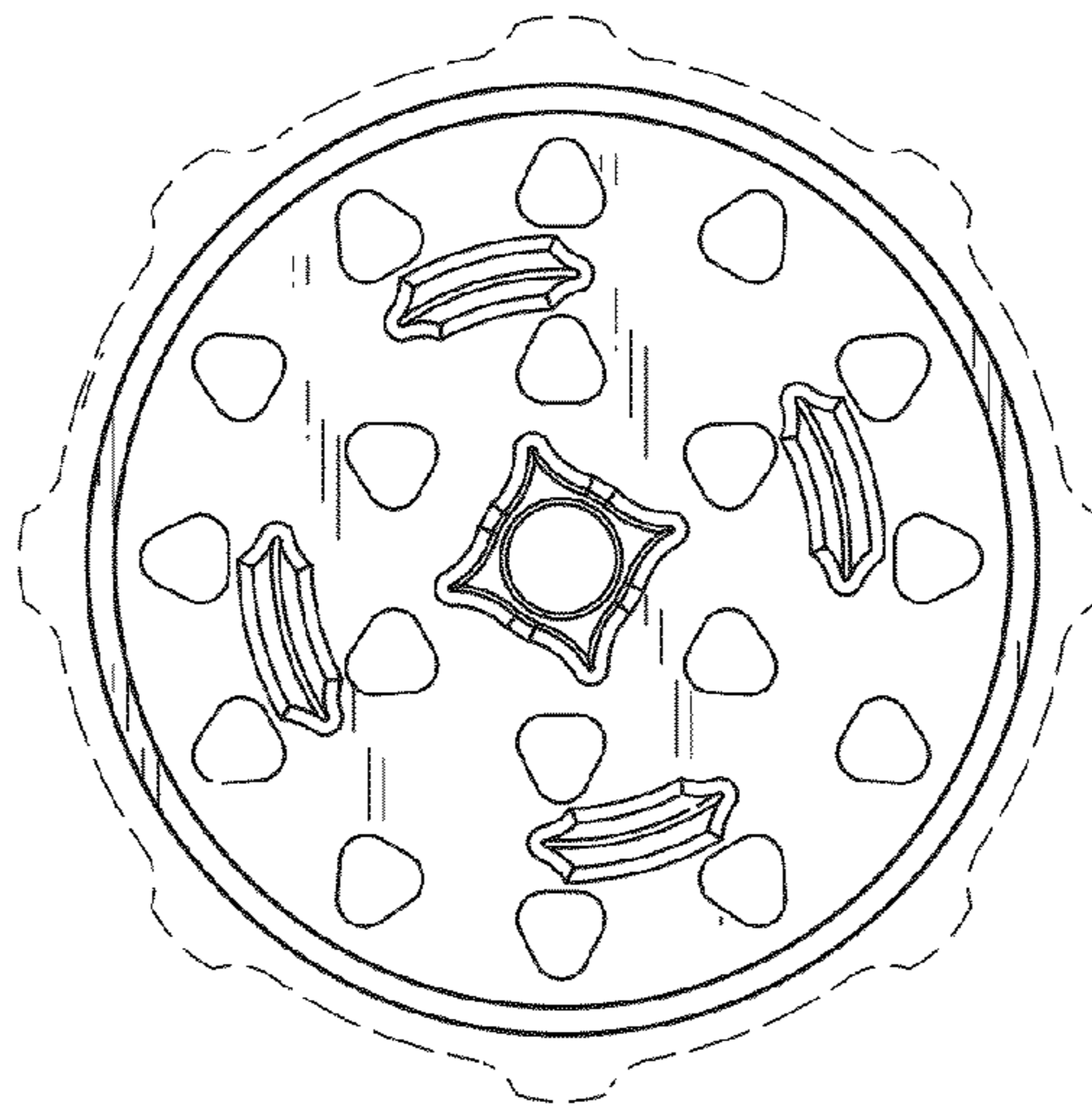

FIG. 11

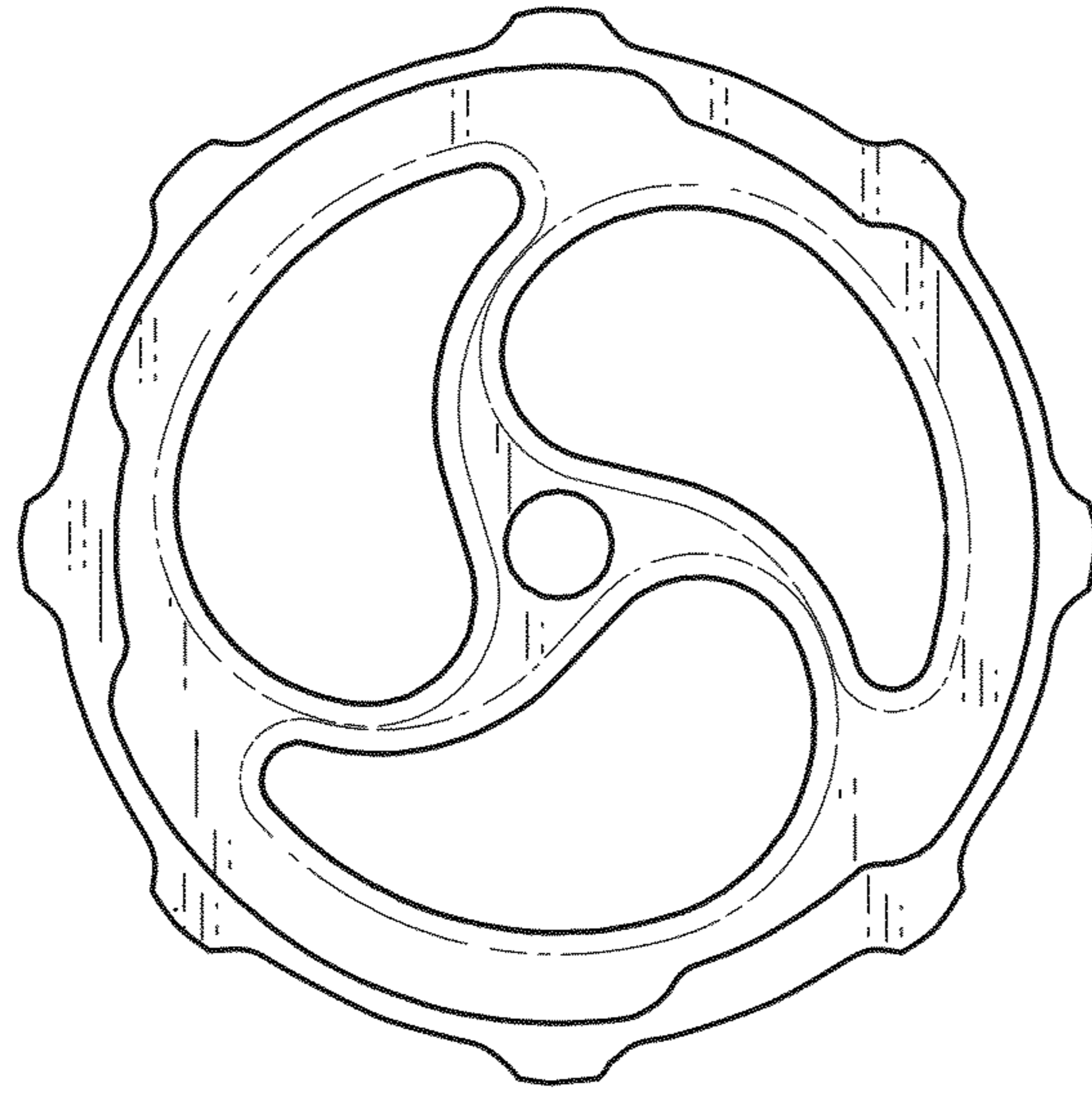

FIG. 12

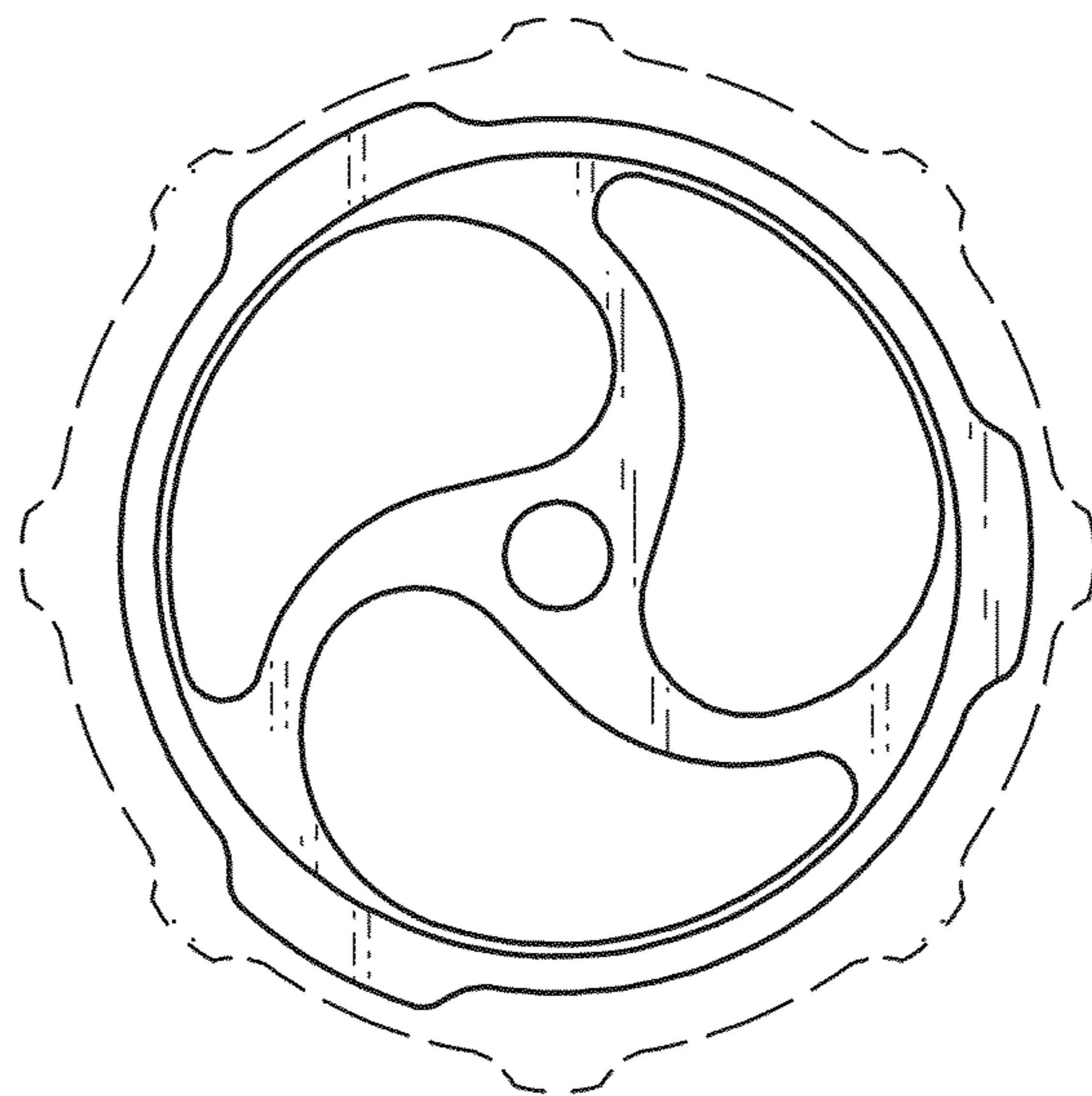

FIG. 13

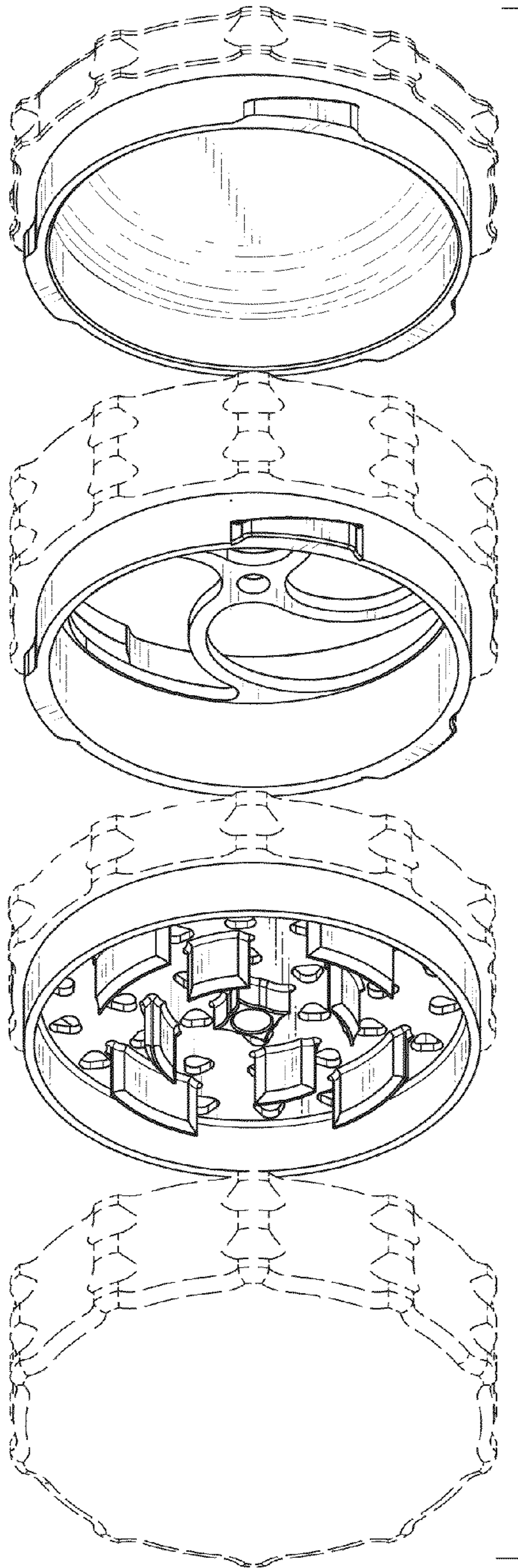

FIG. 14

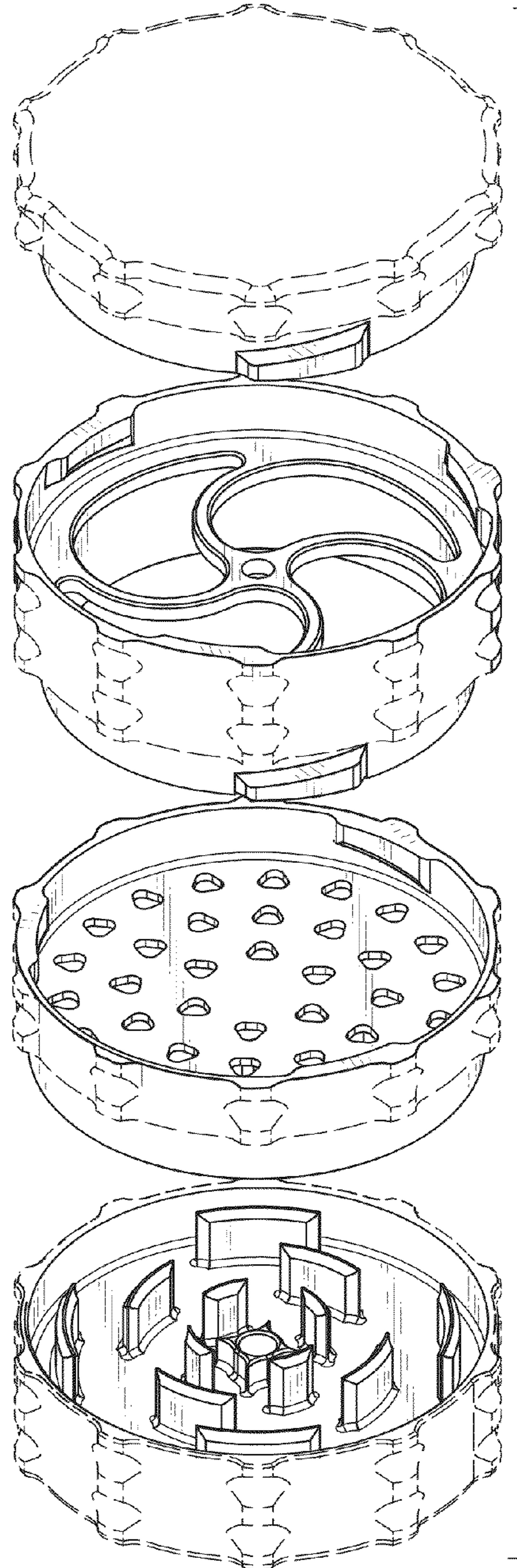

FIG. 15

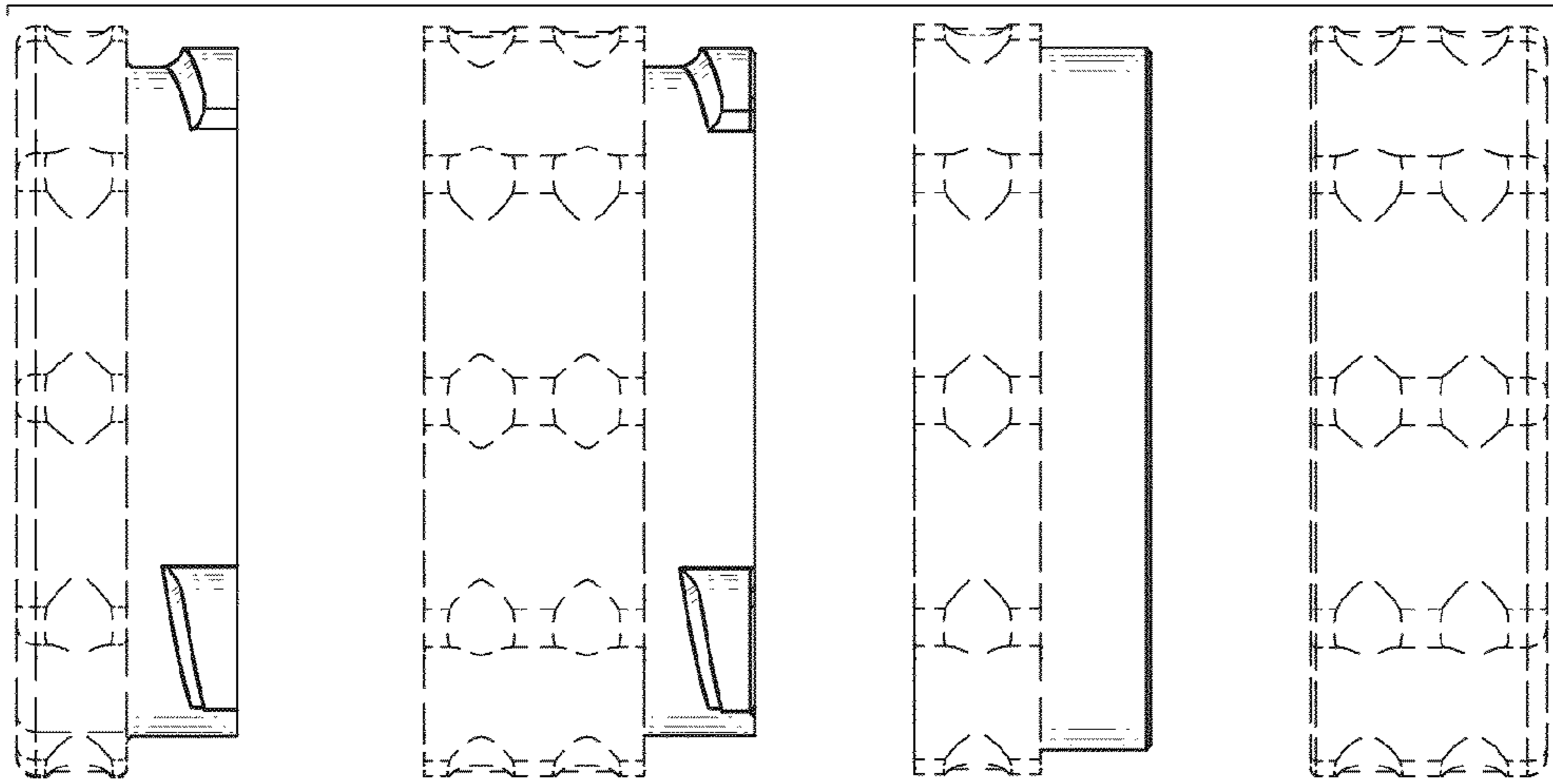

FIG. 18

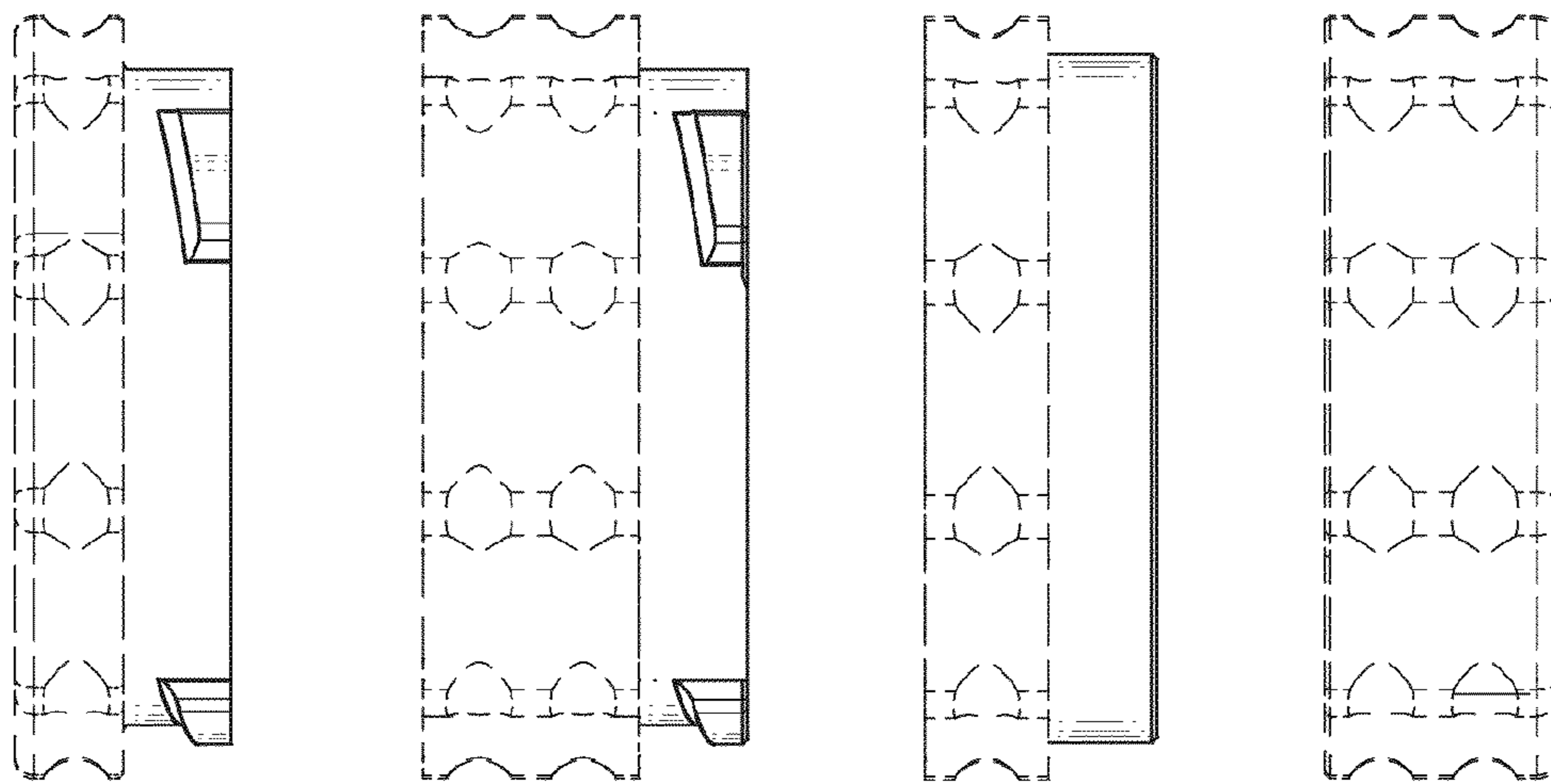

FIG. 17

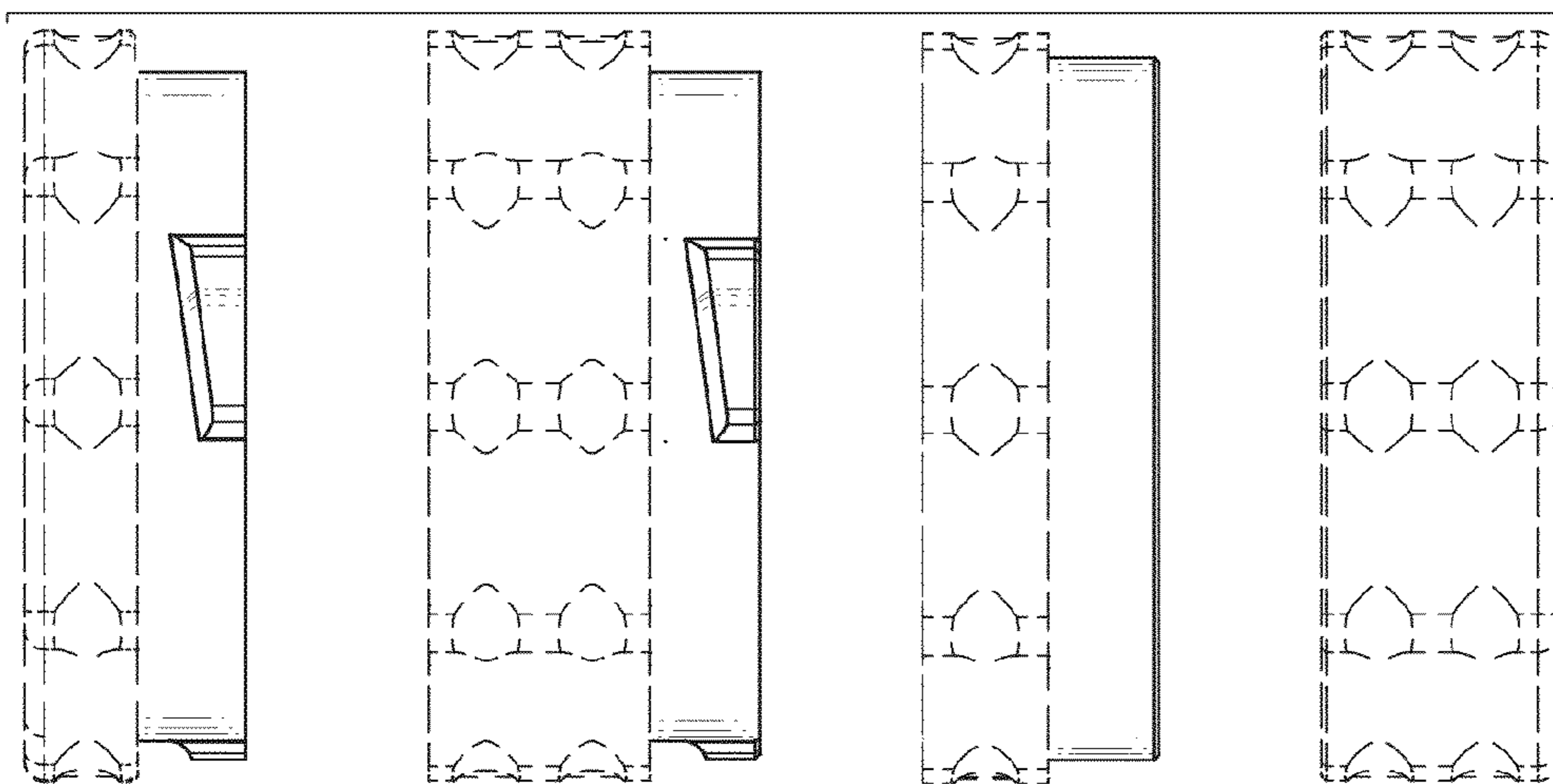

FIG. 16

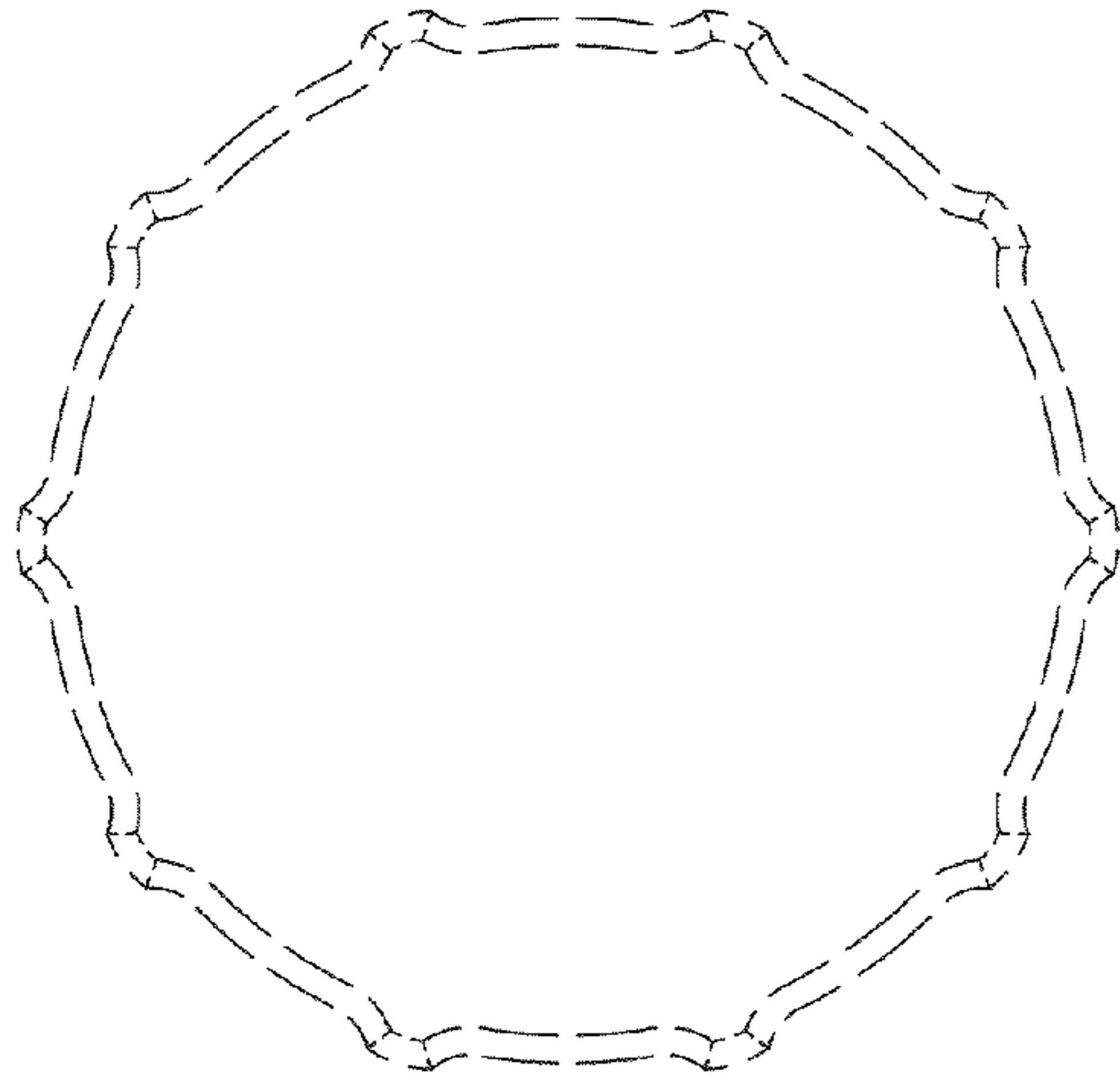

FIG. 20

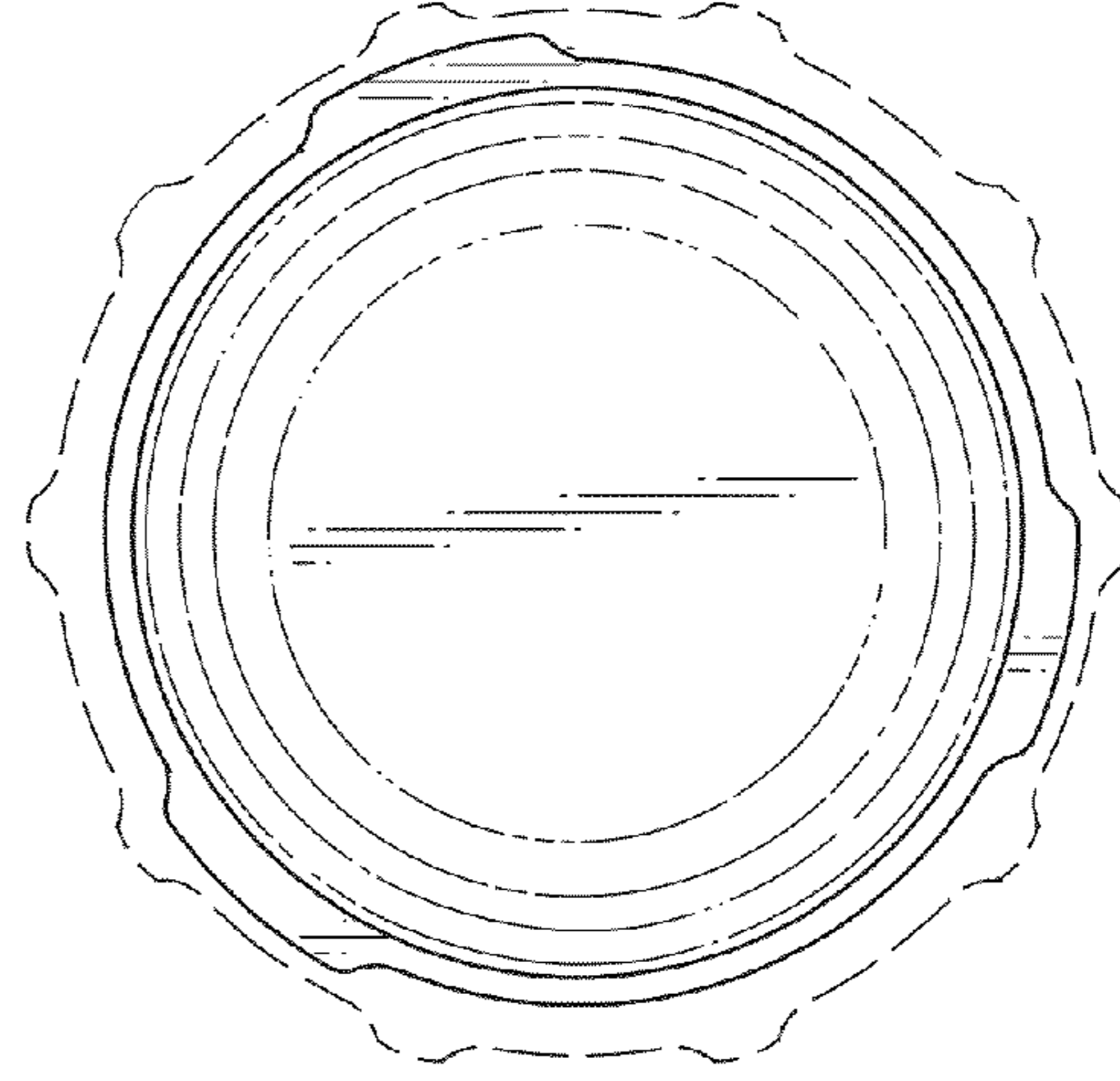

FIG. 21

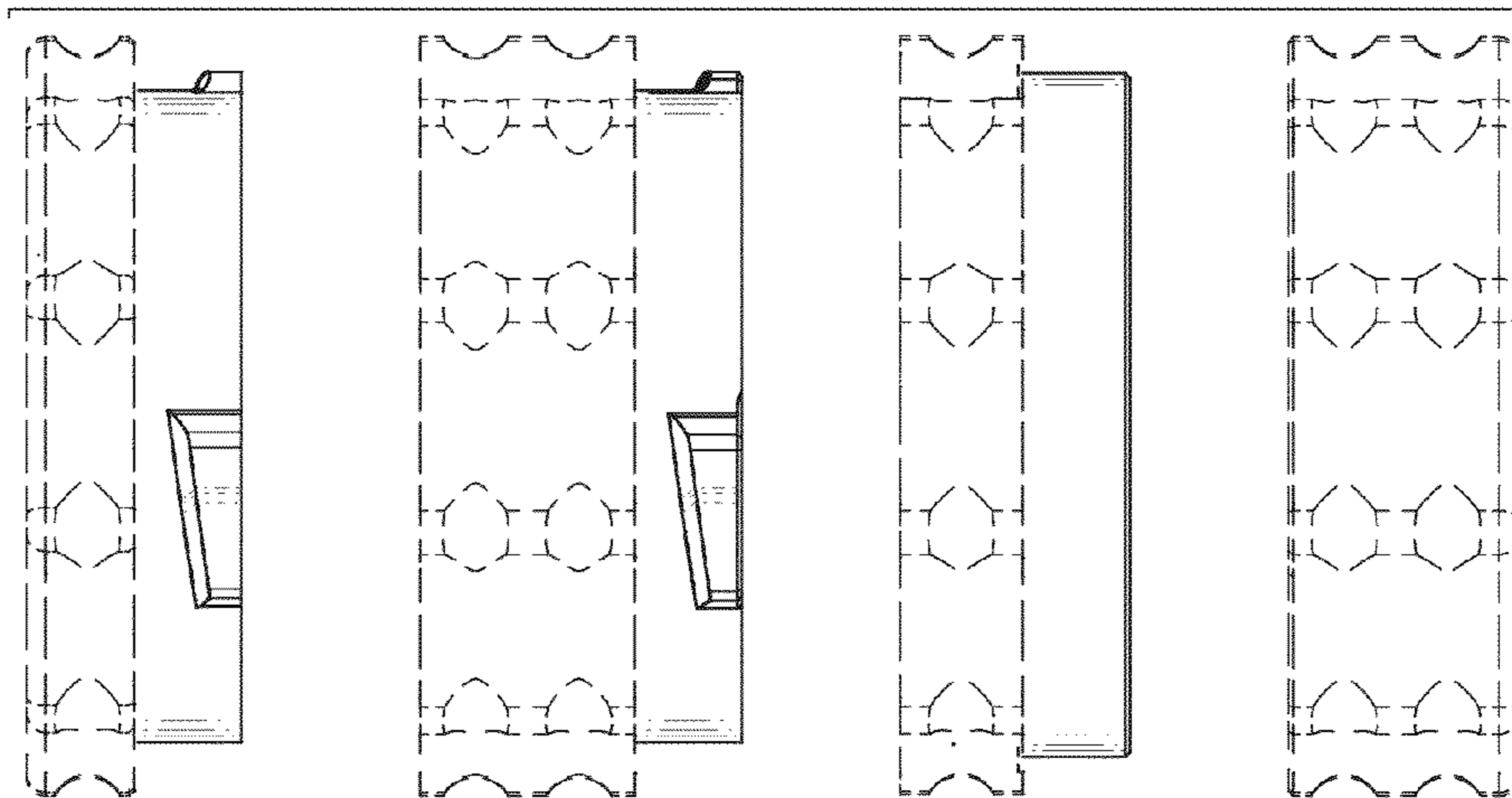

FIG. 19

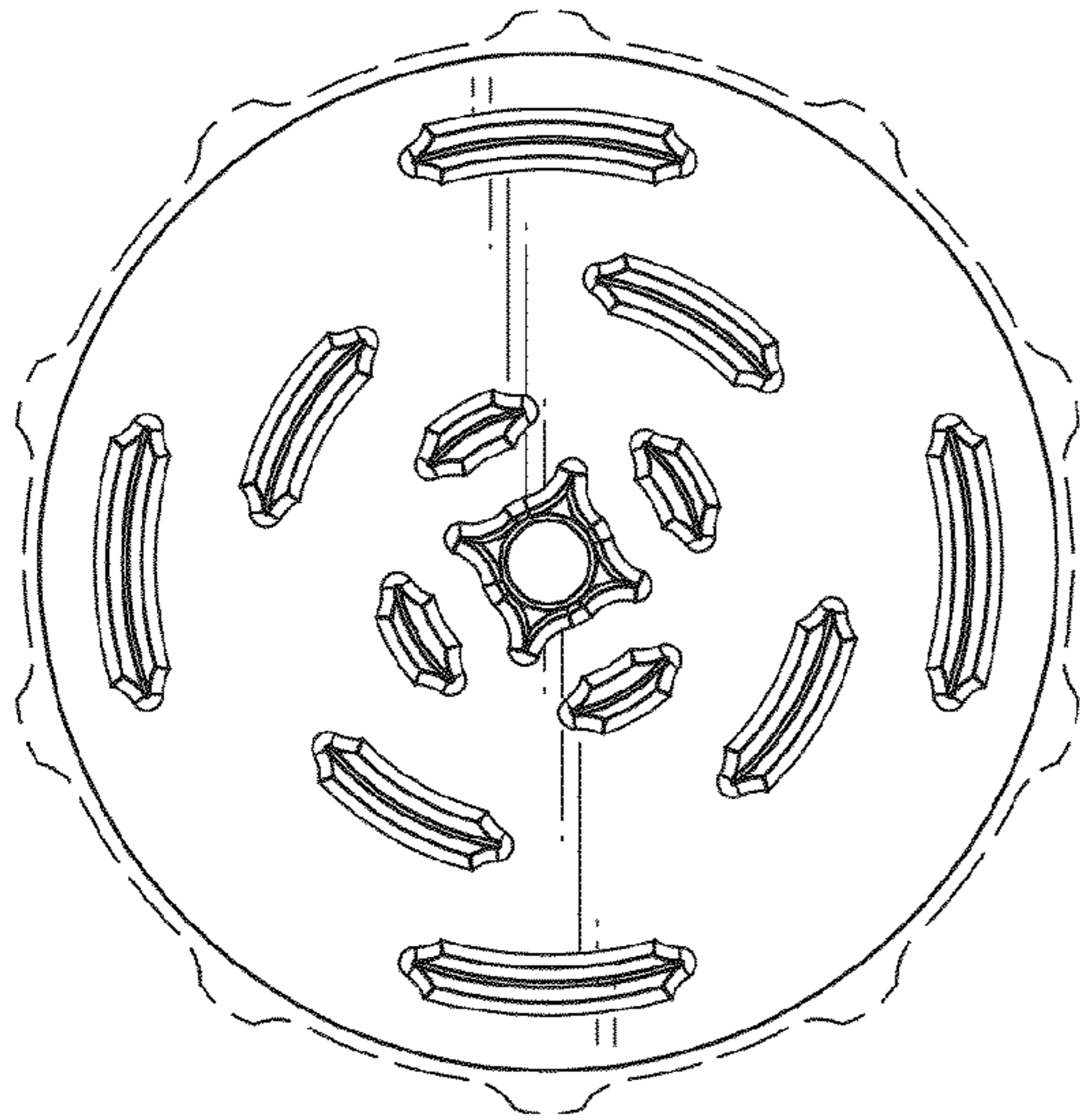

FIG. 22

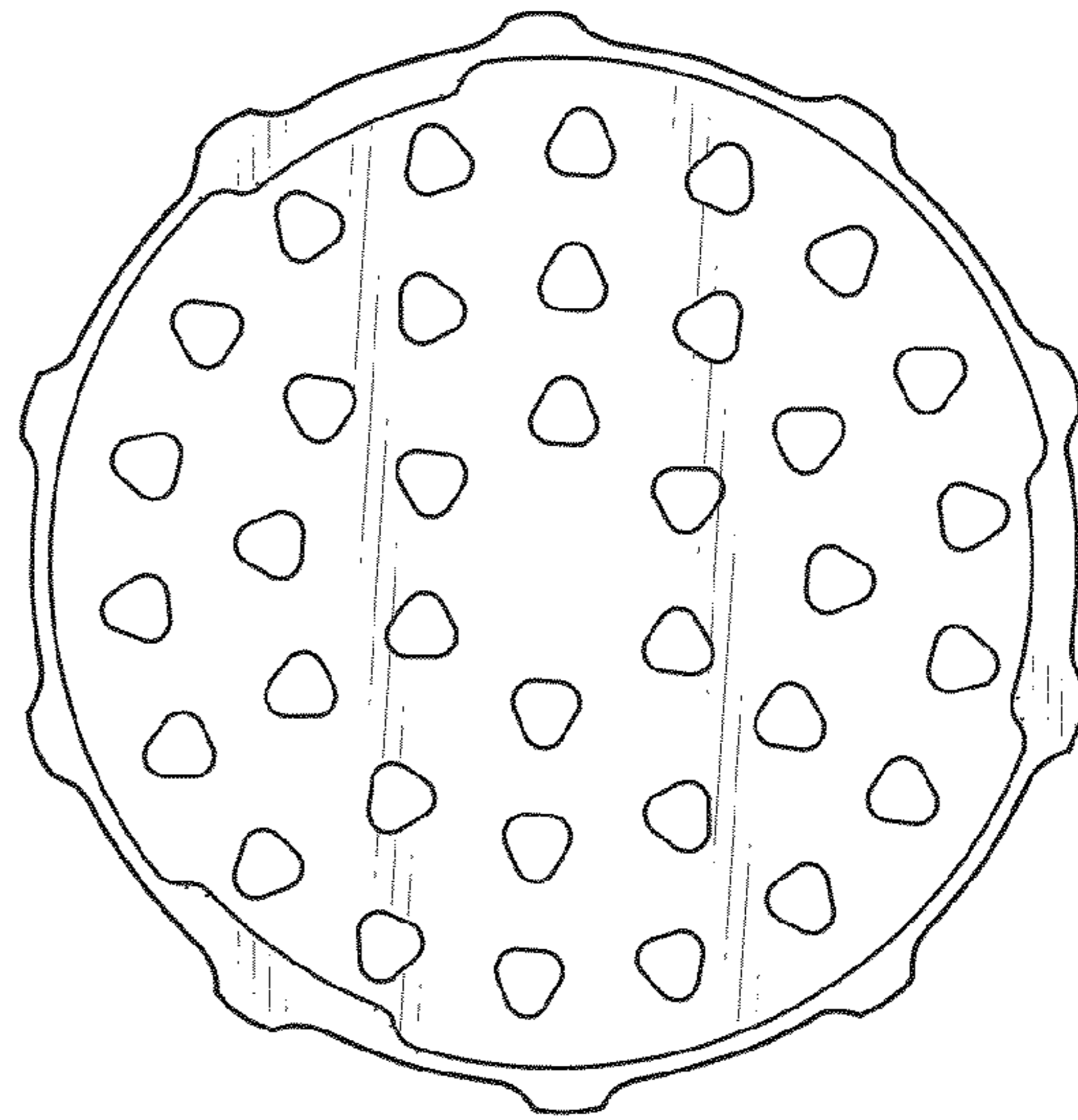

FIG. 23

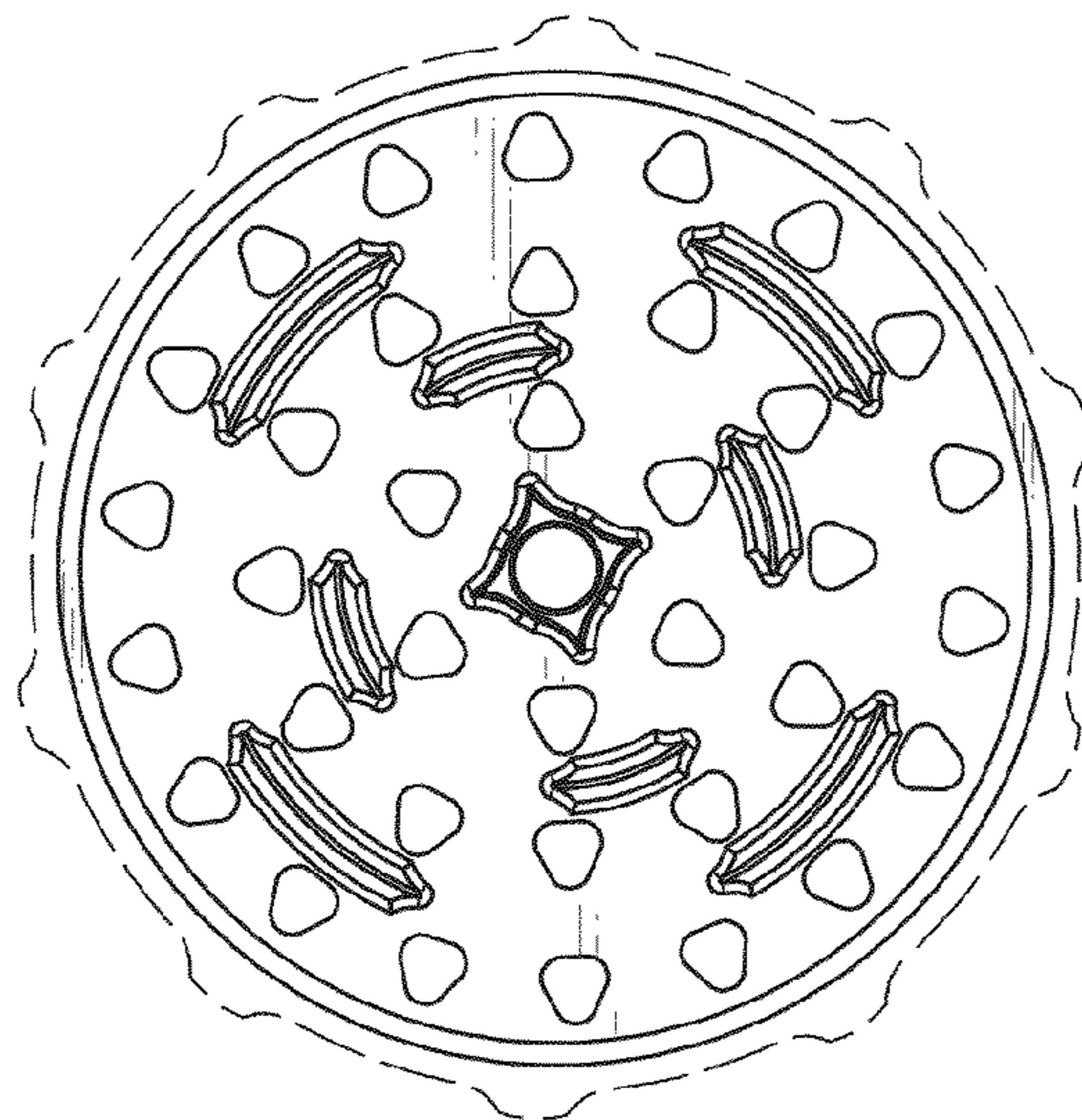

FIG. 24

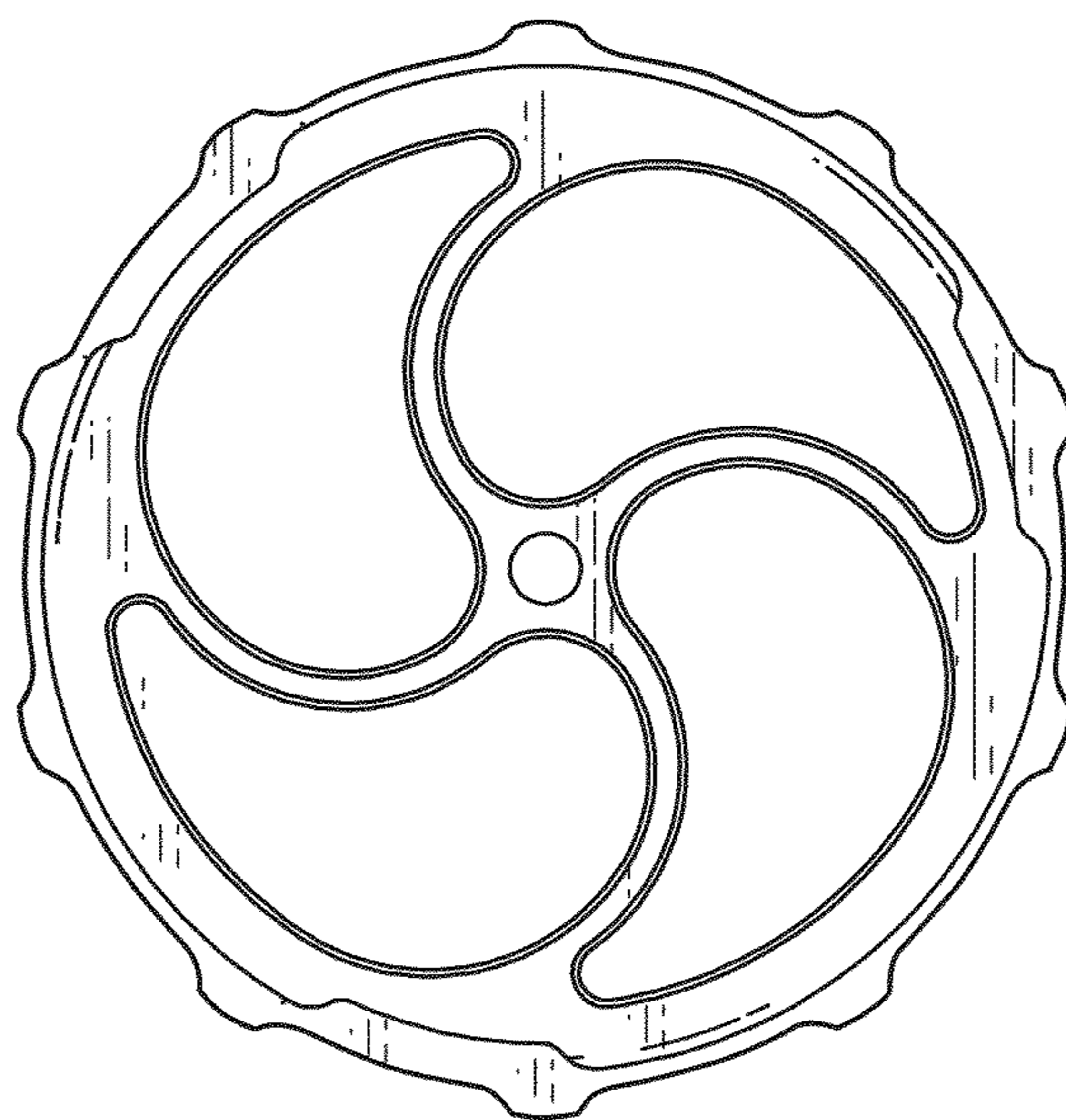

FIG. 25

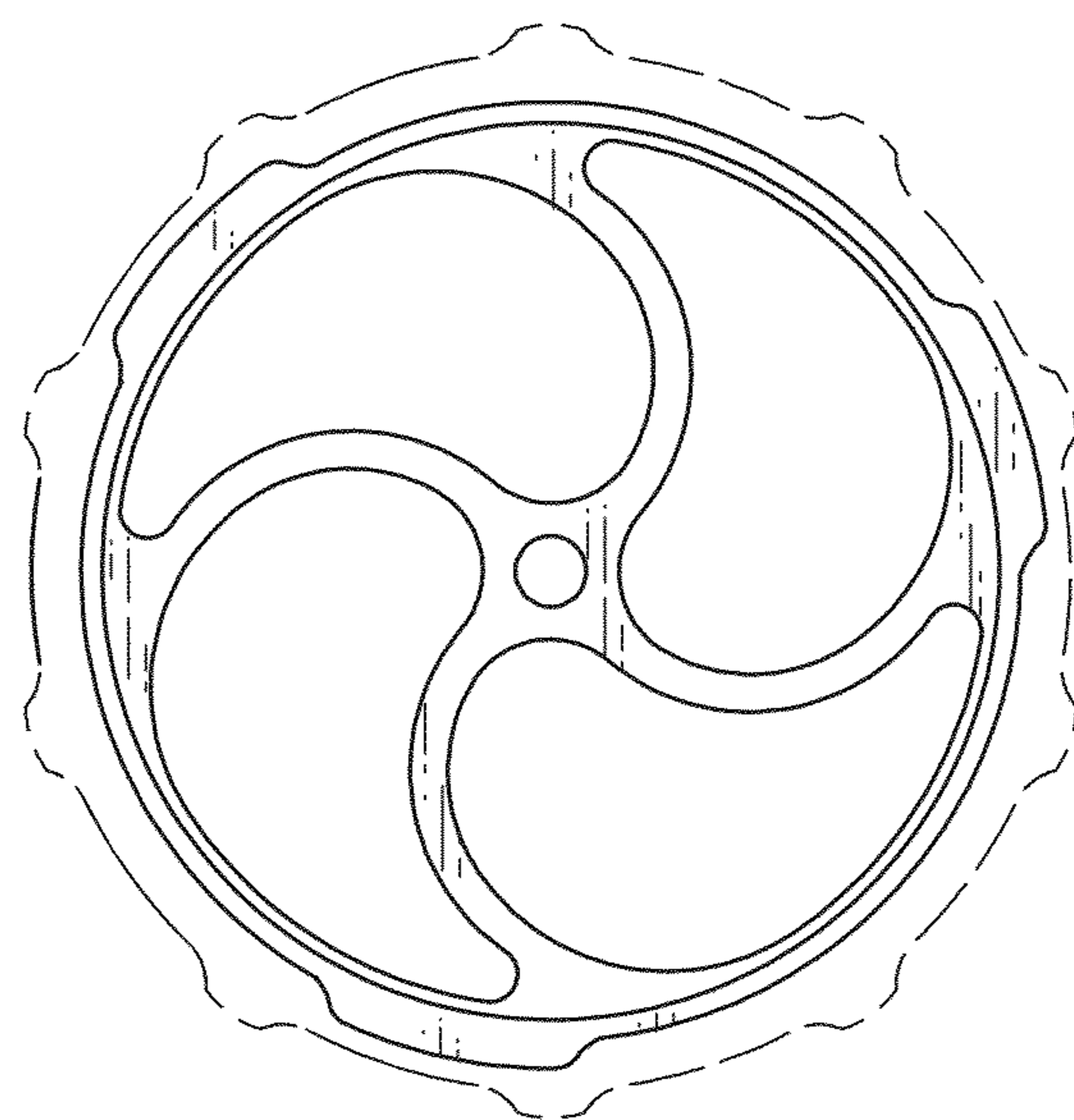

FIG. 26

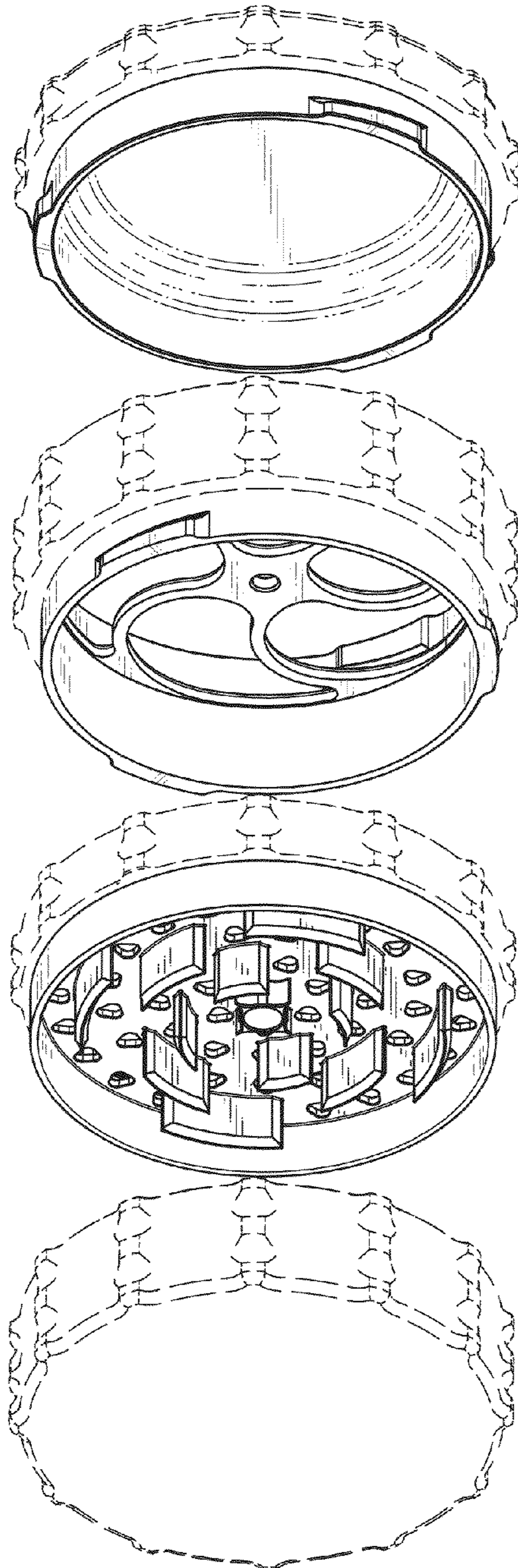

FIG. 27

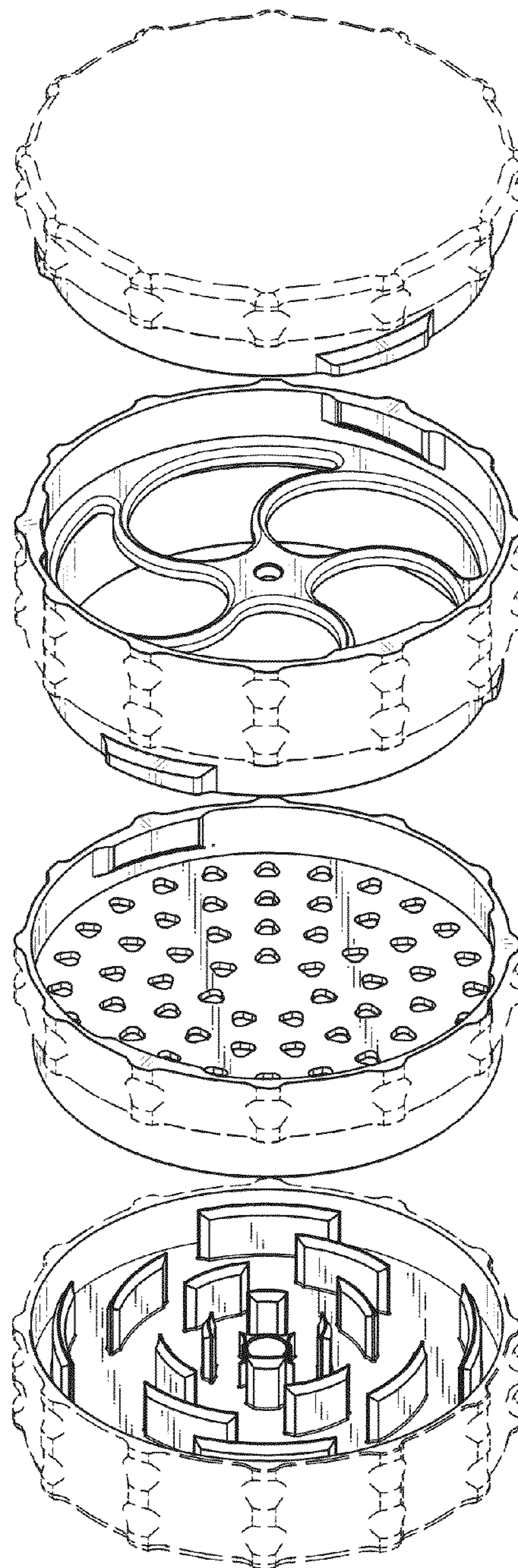

FIG. 28

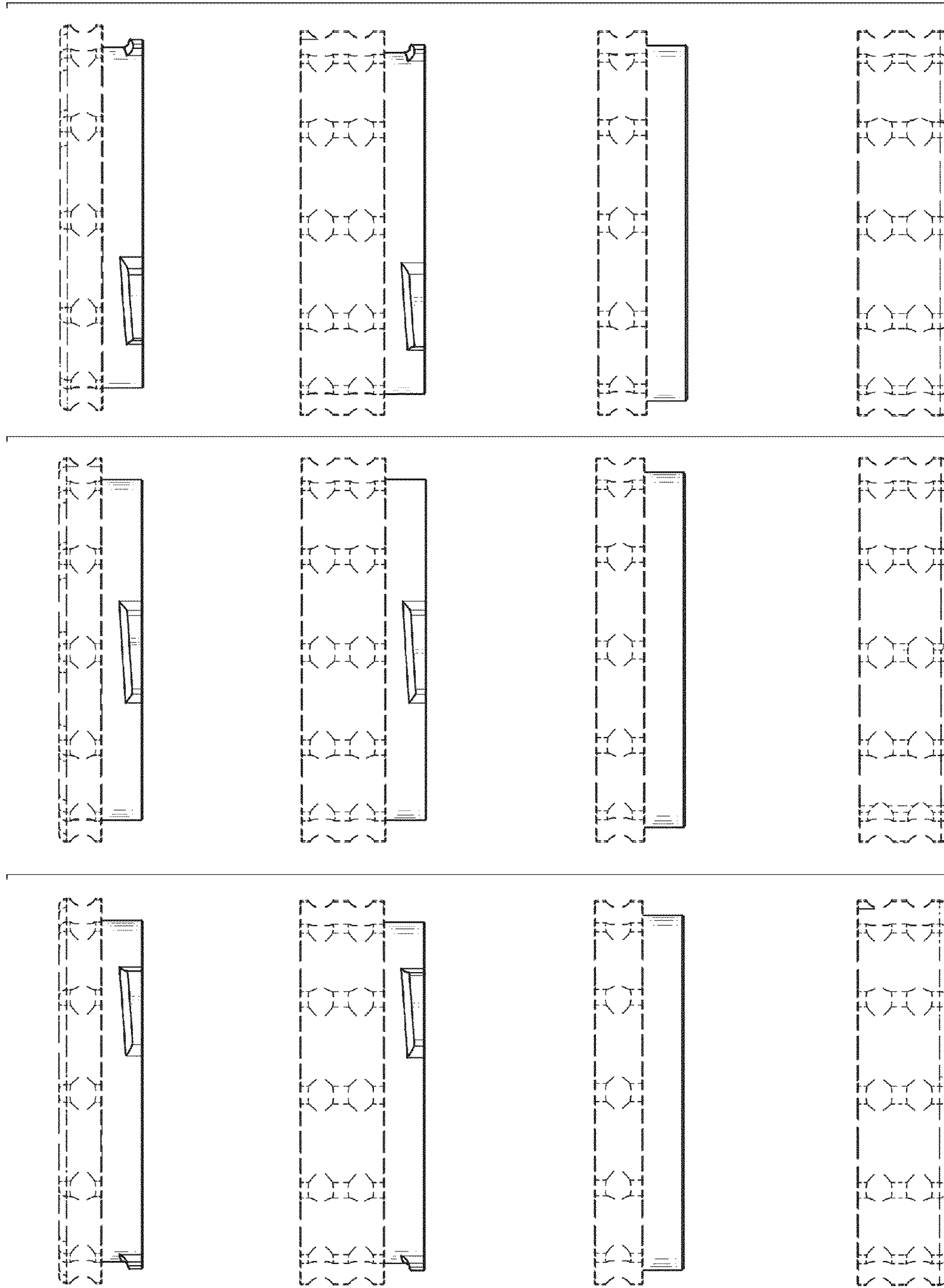

FIG. 31

FIG. 30

FIG. 29

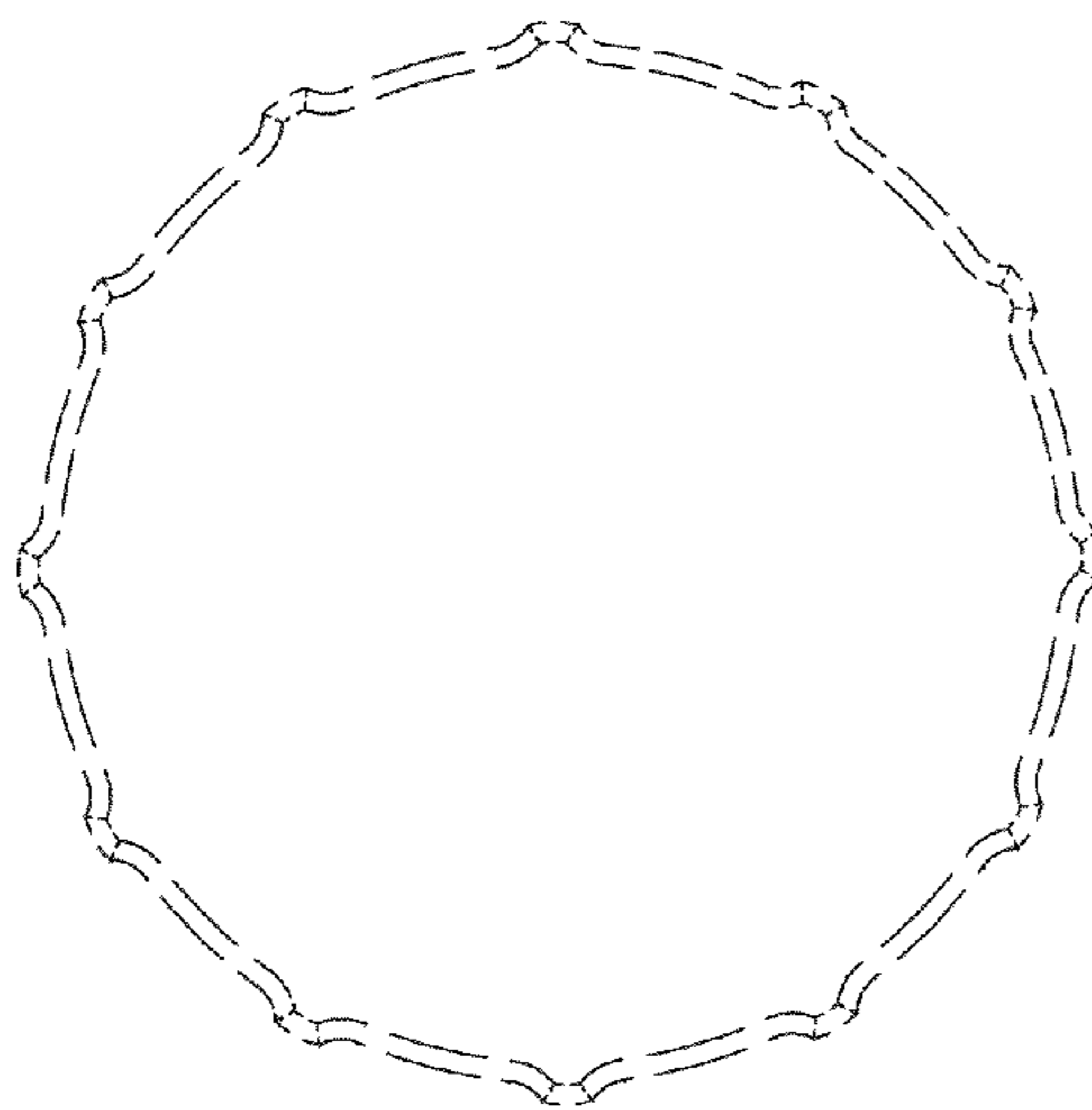

FIG. 33

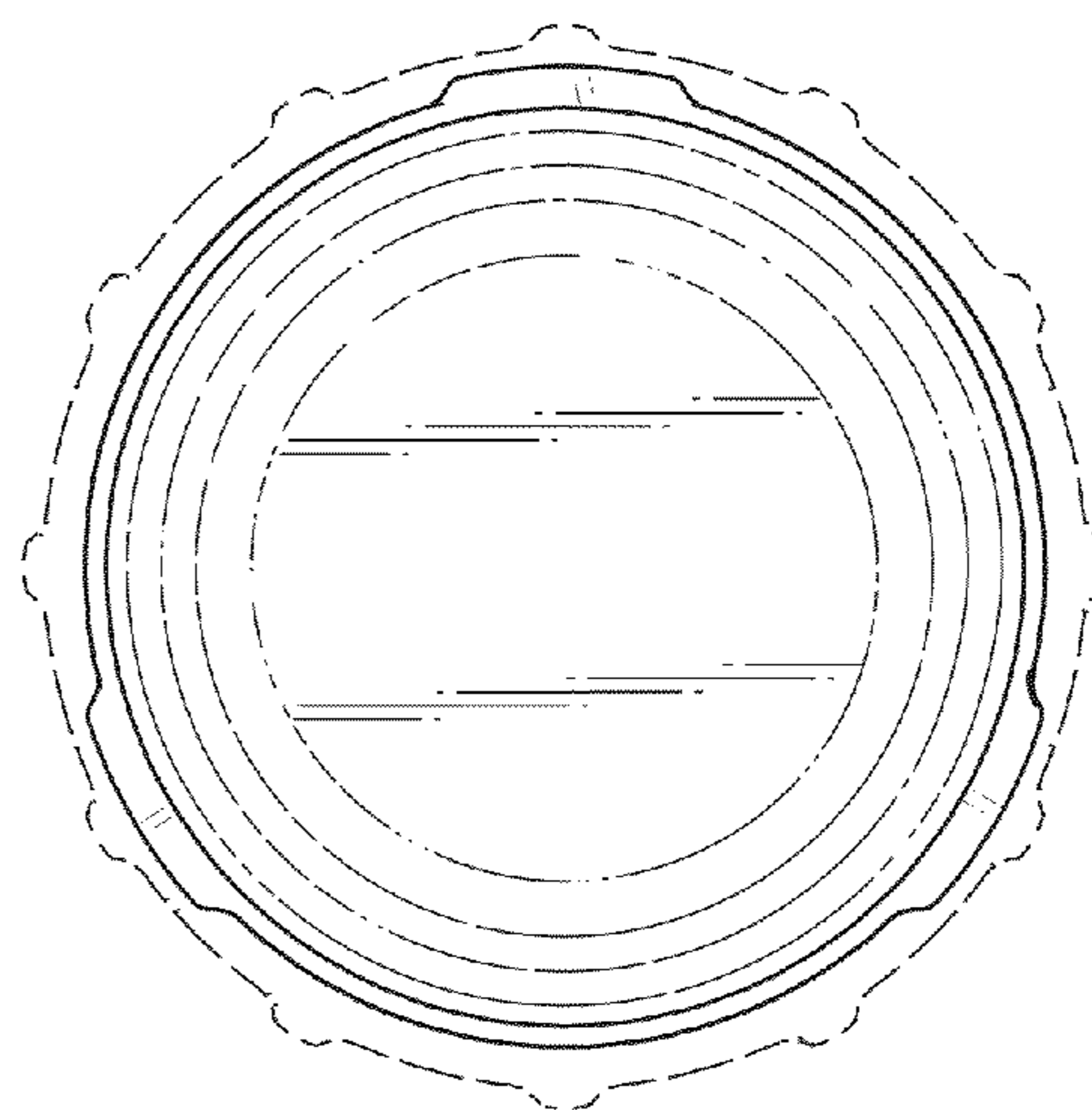

FIG. 34

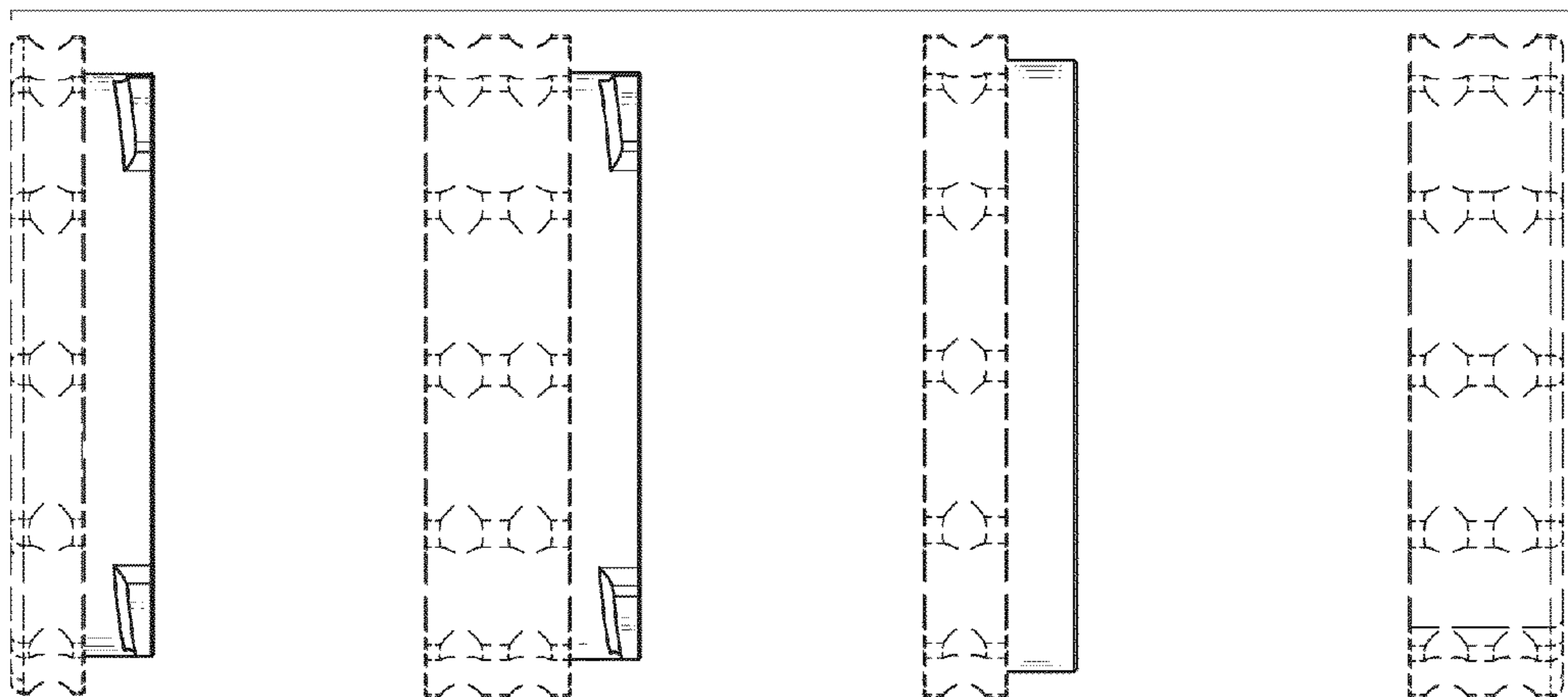

FIG. 32

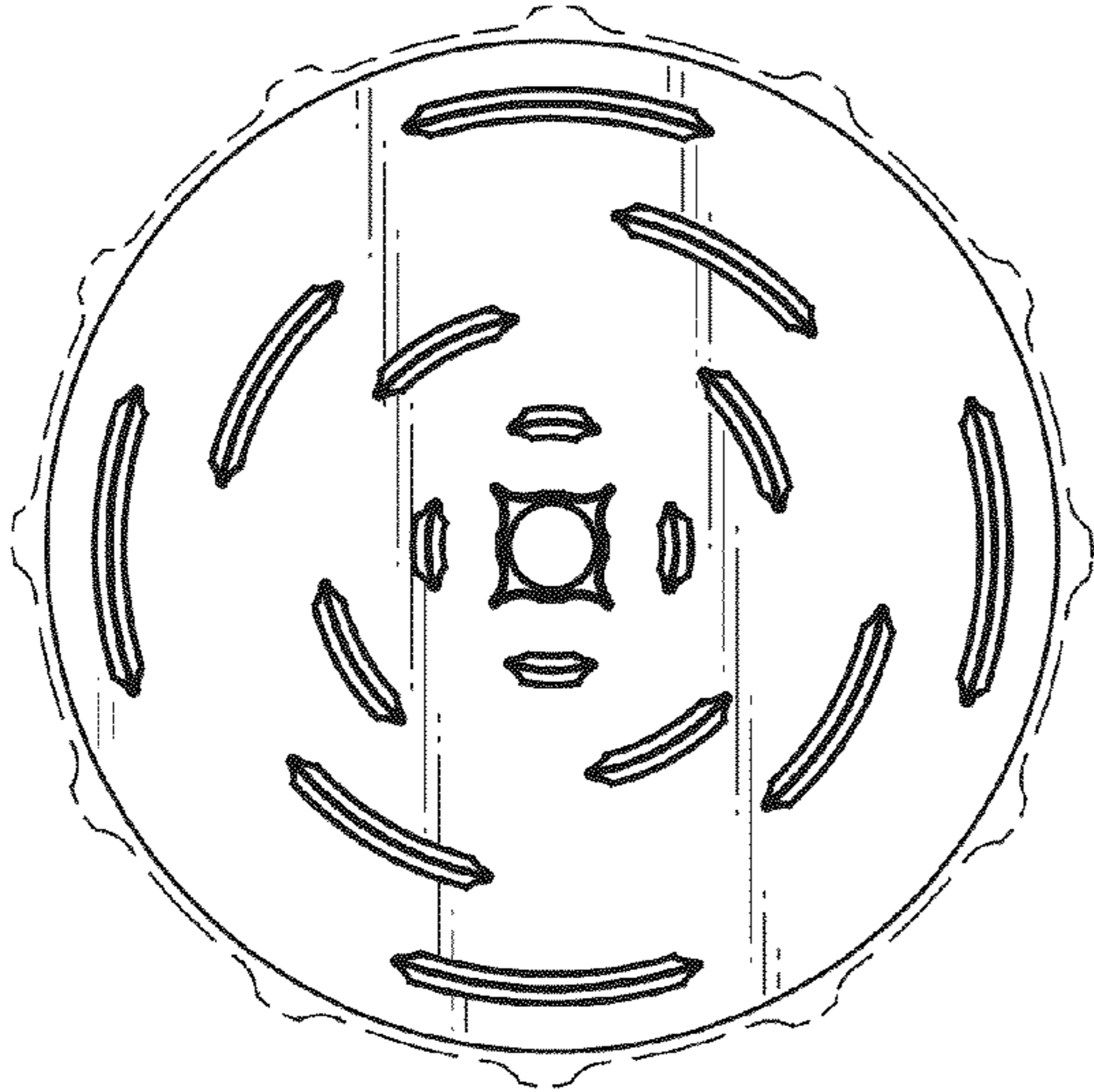

FIG. 35

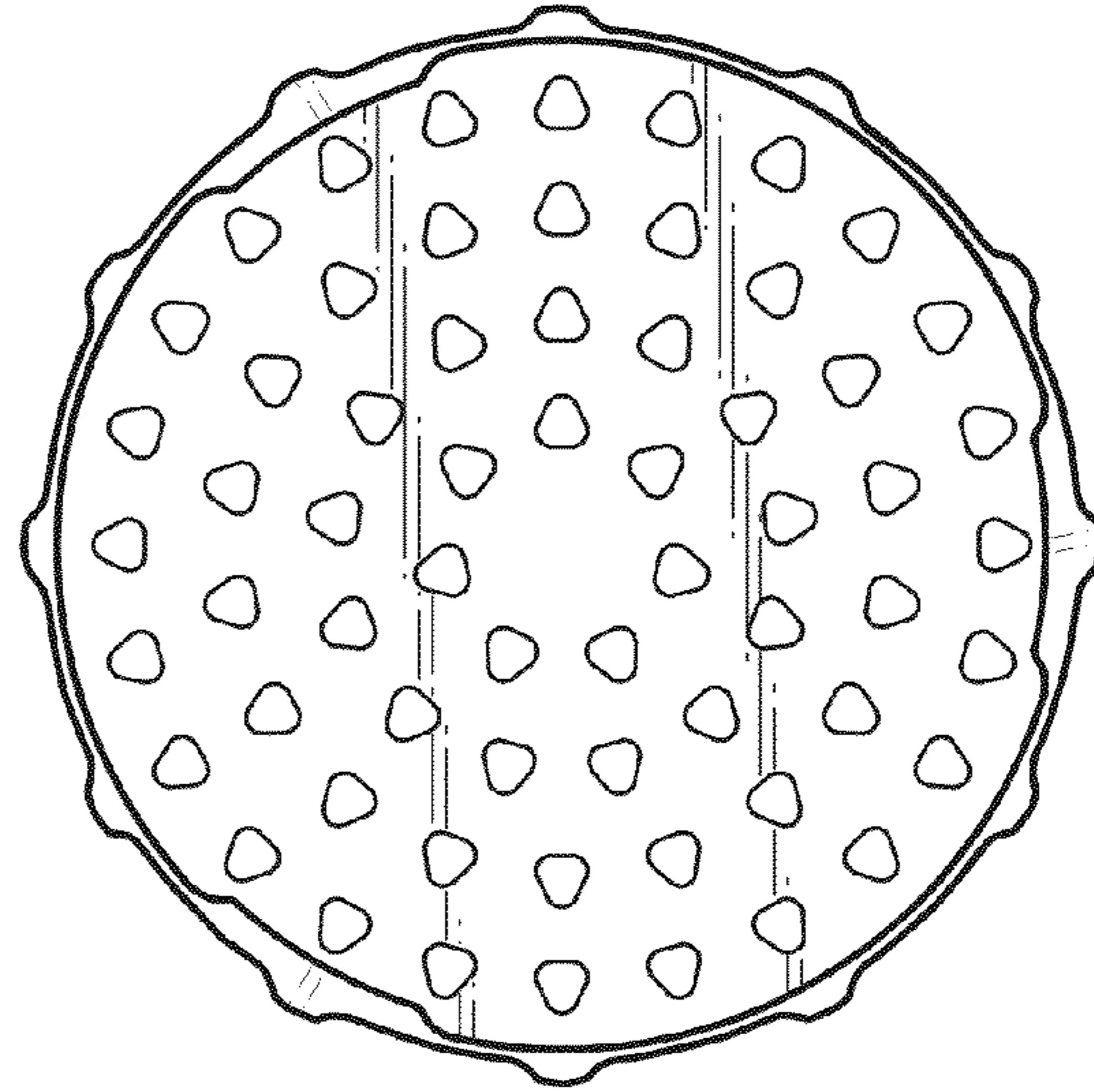

FIG. 36

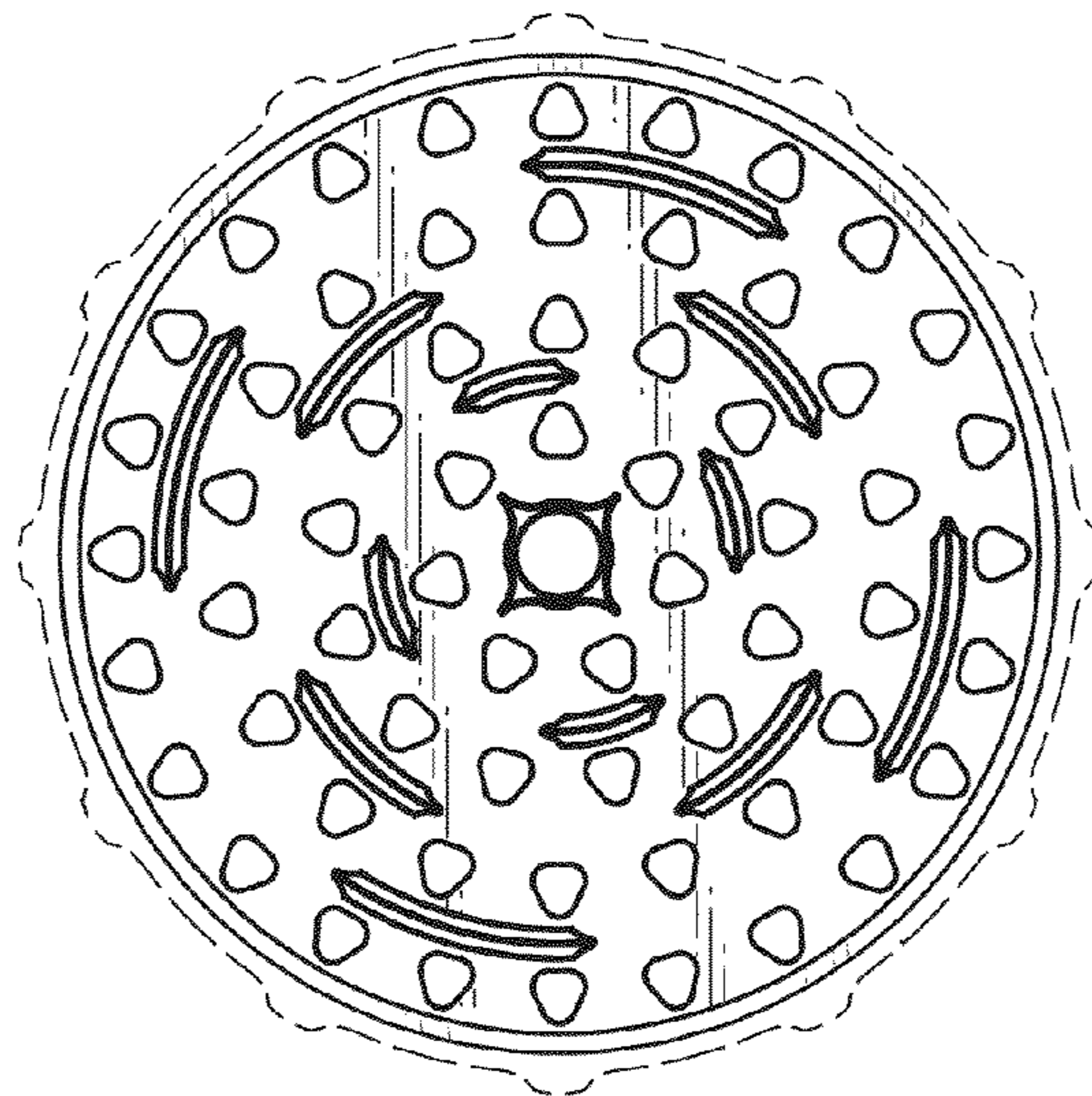

FIG. 37

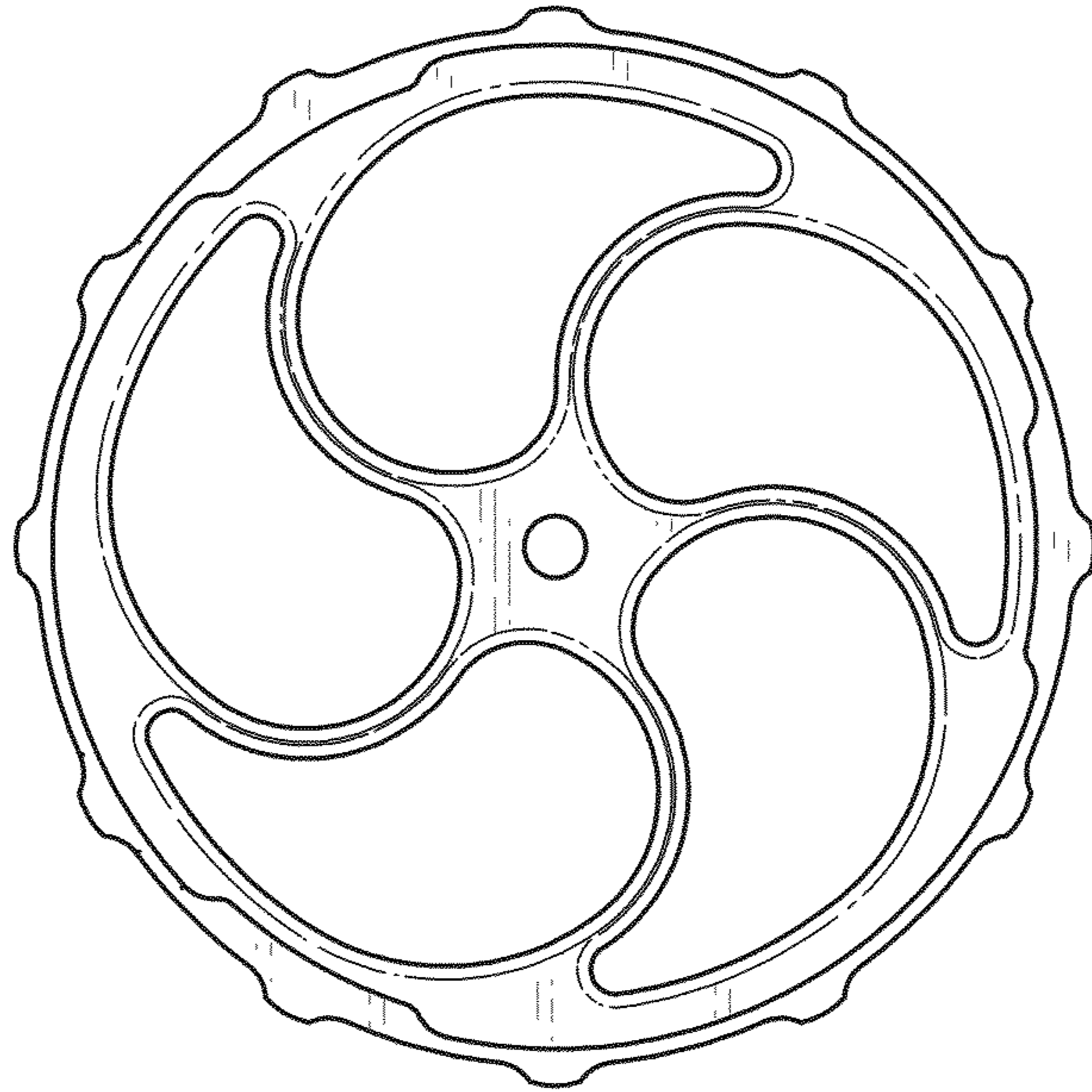

FIG. 38

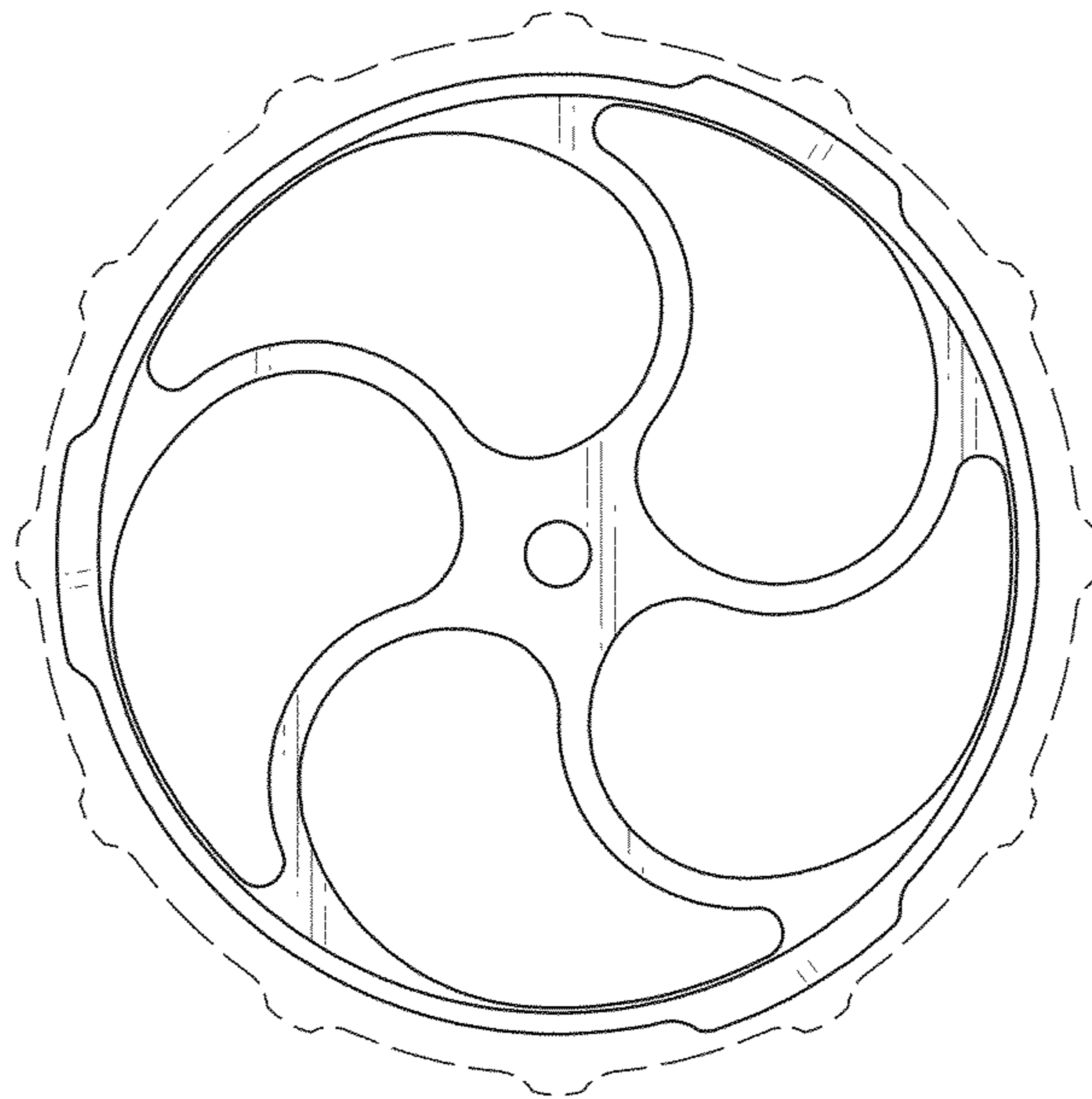

FIG. 39