



US00D754989S

(12) **United States Design Patent**  
**Garshon et al.**

(10) **Patent No.:** **US D754,989 S**

(45) **Date of Patent:** **\*\* May 3, 2016**

(54) **PHARMACEUTICAL SAMPLE  
DISTRIBUTION DEVICE**

(71) Applicant: **BRANDPERX LLC**, New Albany, OH  
(US)

(72) Inventors: **Shauna Garshon**, New Albany, OH  
(US); **Jeff Garshon**, New Albany, OH  
(US)

(73) Assignee: **Brandperx LLC**, New Albany, OH (US)

(\*\*) Term: **14 Years**

(21) Appl. No.: **29/507,499**

(22) Filed: **Oct. 28, 2014**

**Related U.S. Application Data**

(63) Continuation-in-part of application No. 13/618,579,  
filed on Sep. 14, 2012, now abandoned.

(51) **LOC (10) Cl.** ..... **03-01**

(52) **U.S. Cl.**  
USPC ..... **D6/517**

(58) **Field of Classification Search**  
USPC ..... D6/512–520; D20/1; D9/455–457, 733,  
D9/736  
CPC ..... B65D 83/0805; B65D 85/672; B65D  
83/0894; B65D 85/04; B65D 85/671; B65D  
5/5057; B65D 5/5035; B65D 75/5838; B65D  
2209/00; B65D 2519/00273; B65D  
2519/00323; B65D 2519/00333; B65D  
2519/00497; B65D 2519/00815

See application file for complete search history.

(56) **References Cited**

U.S. PATENT DOCUMENTS

D430,438	S	*	9/2000	Phelps	.....	D6/515
D502,621	S	*	3/2005	Ho	.....	D6/515
D509,689	S	*	9/2005	Ho	.....	D6/515
D543,400	S	*	5/2007	Ho	.....	D6/515
D640,077	S	*	6/2011	Jensen	.....	D6/517

\* cited by examiner

*Primary Examiner* — Daniel Bui

*Assistant Examiner* — Khawaja Anwar

(74) *Attorney, Agent, or Firm* — Hahn, Loeser & Parks,  
LLP; Lorraine Hernandez

(57) **CLAIM**

The ornamental design for a pharmaceutical sample distribu-  
tion device, as shown and described.

**DESCRIPTION**

FIG. 1 is a top and front perspective view of a pharmaceutical  
sample distribution device, showing our new design;  
FIG. 2 is a bottom and front perspective view thereof;  
FIG. 3 is a front view thereof;  
FIG. 4 is a rear view thereof;  
FIG. 5 is a left view thereof;  
FIG. 6 is a right view thereof;  
FIG. 7 is a top view thereof; and,  
FIG. 8 is a bottom view thereof.

**1 Claim, 3 Drawing Sheets**

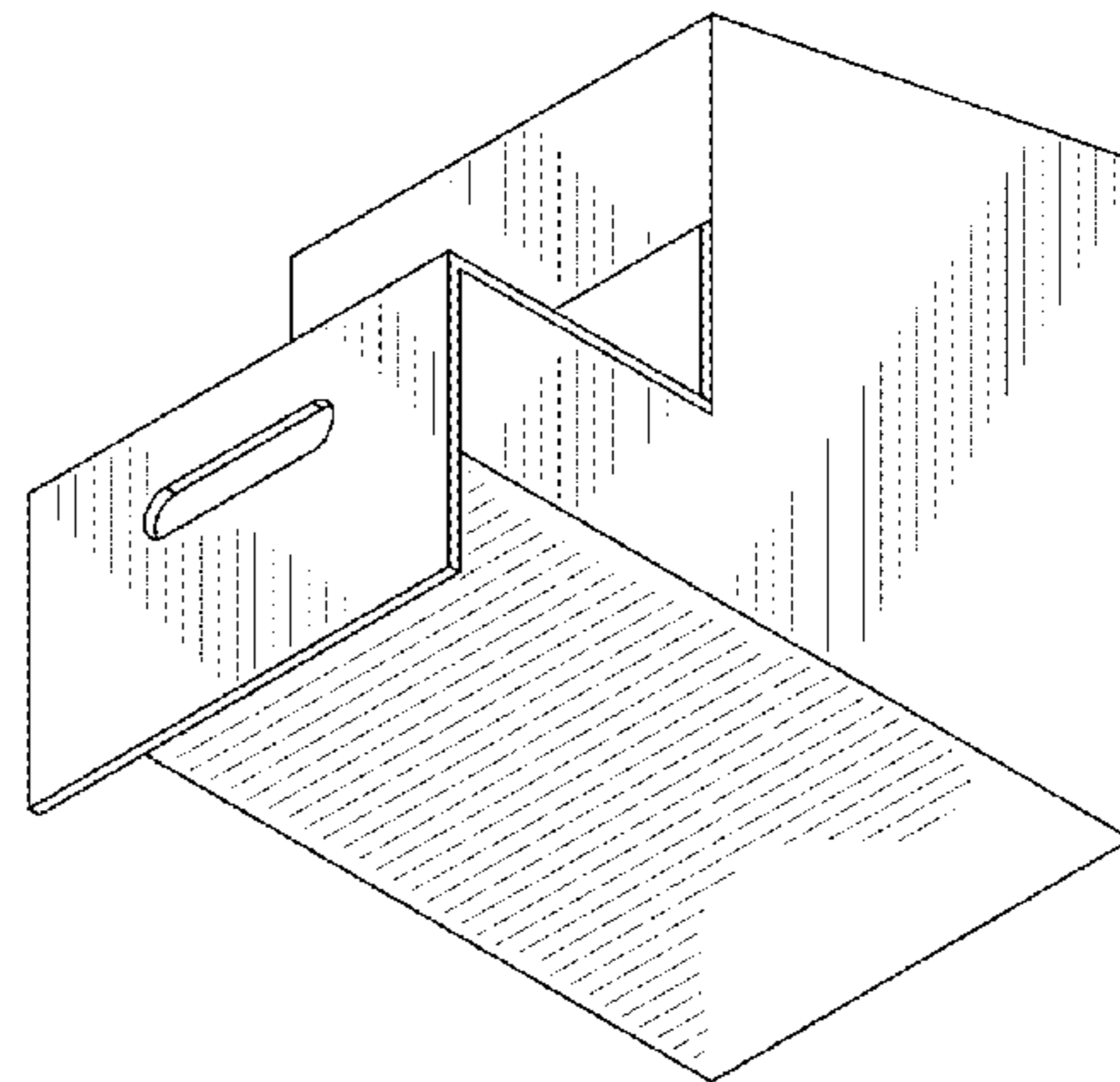
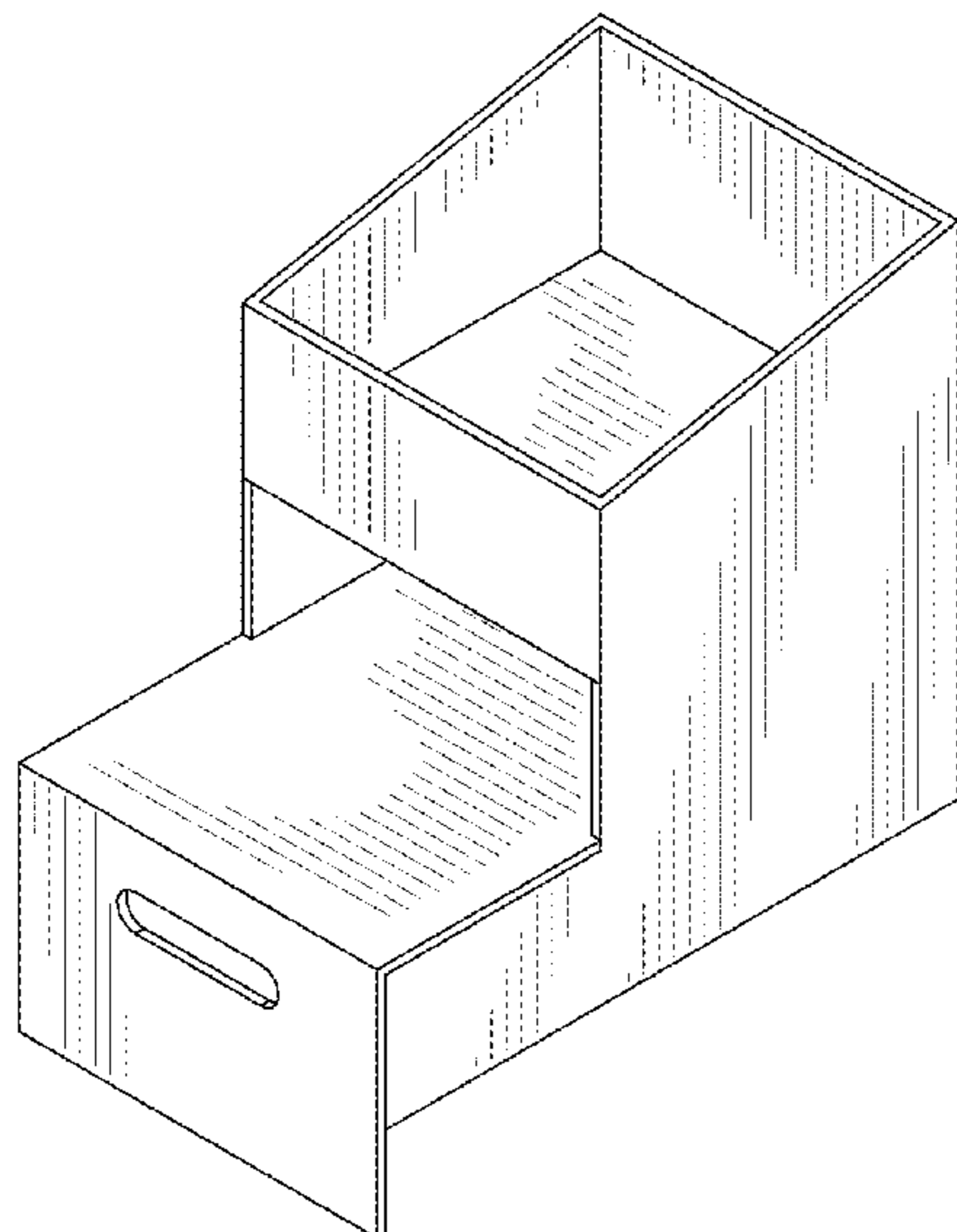

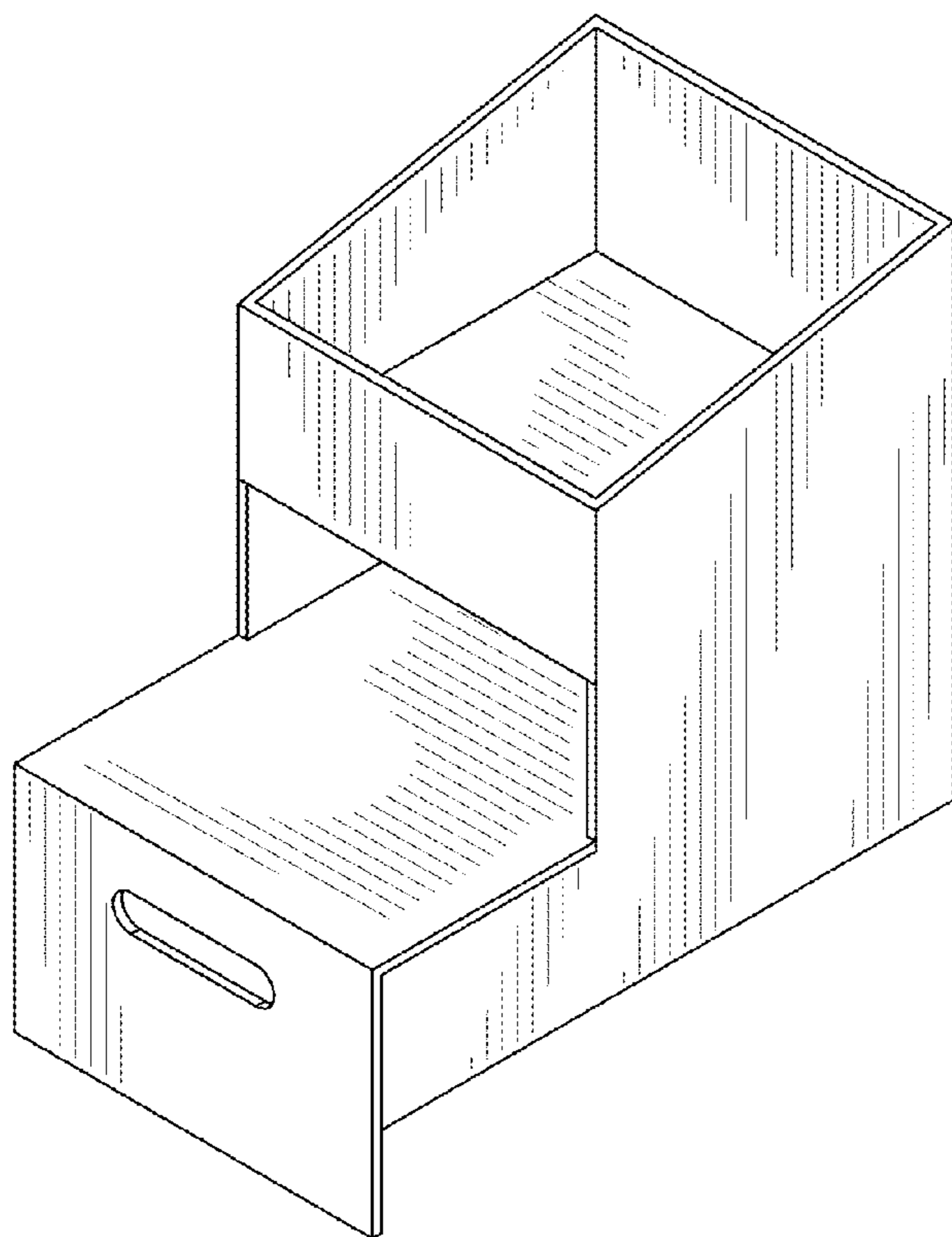

FIG. 1

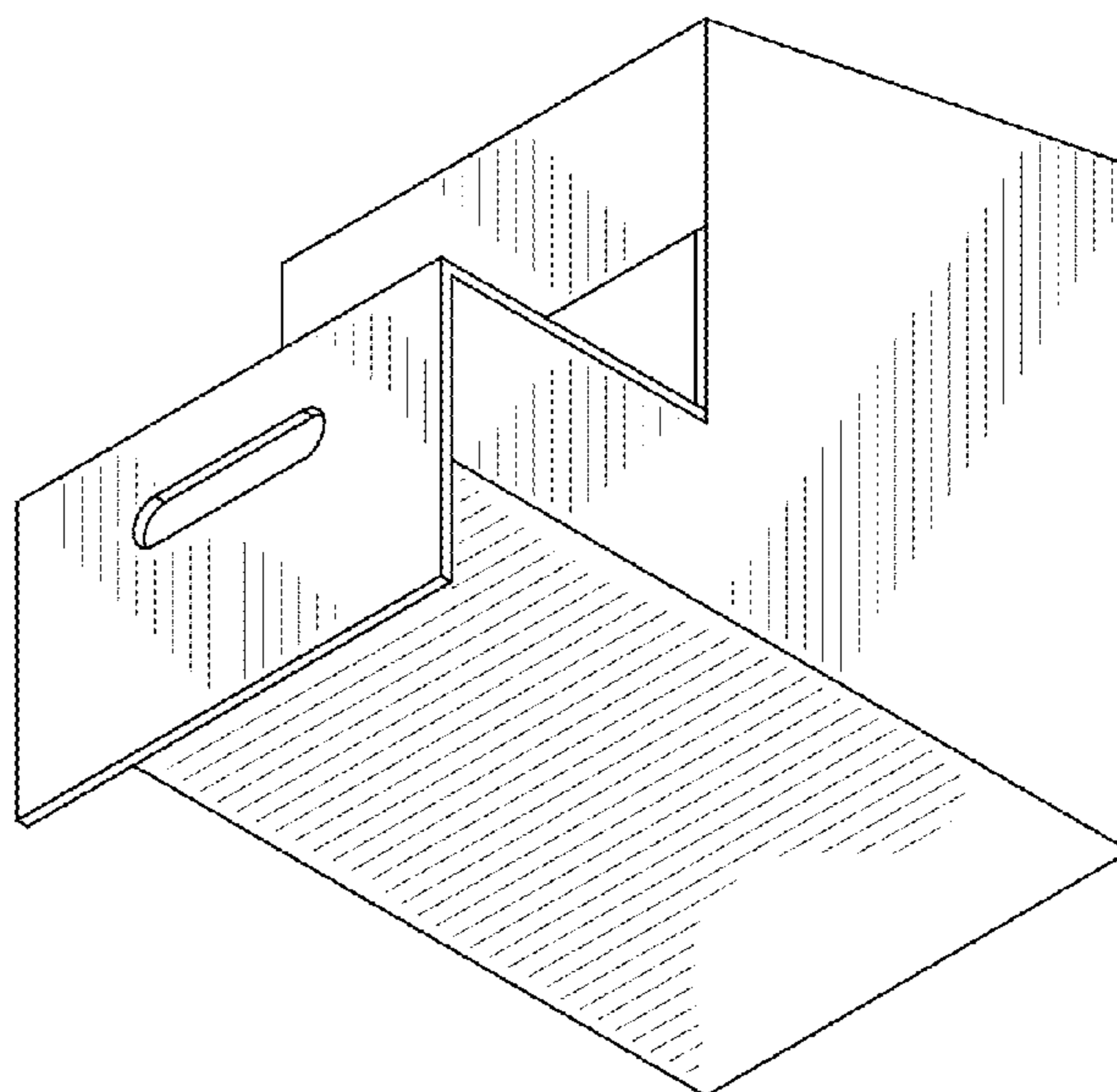

FIG. 2

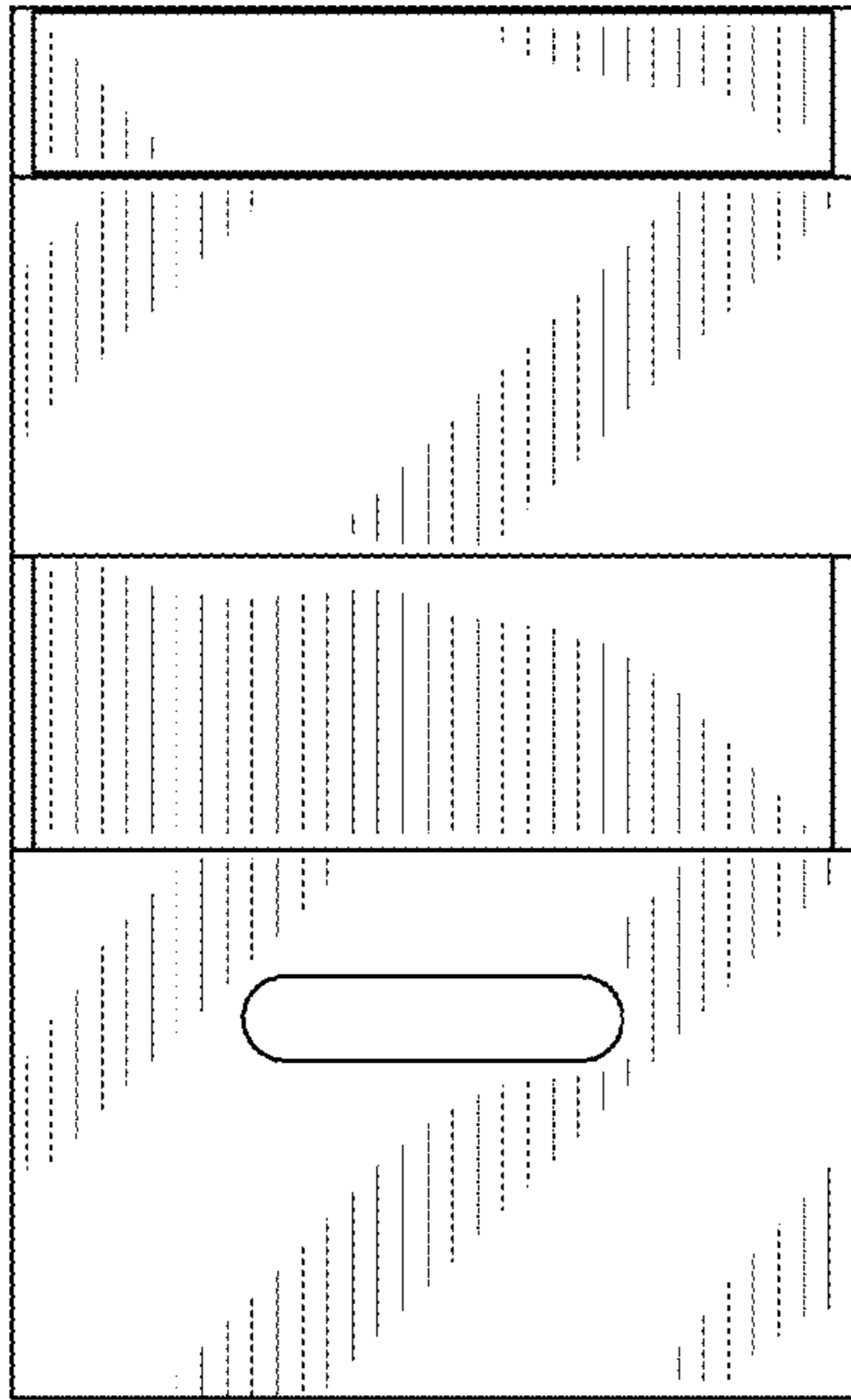

FIG. 3

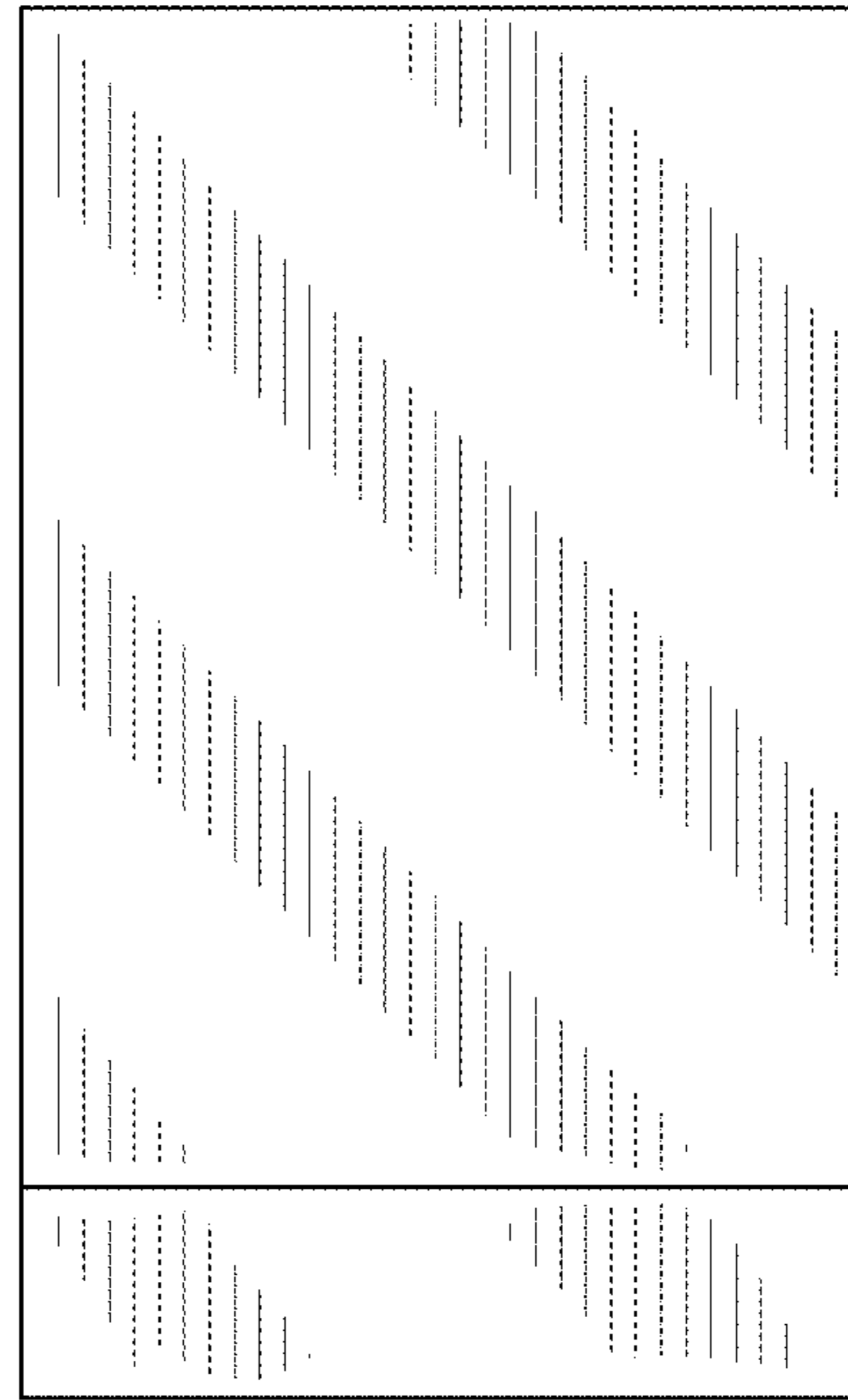

FIG. 4

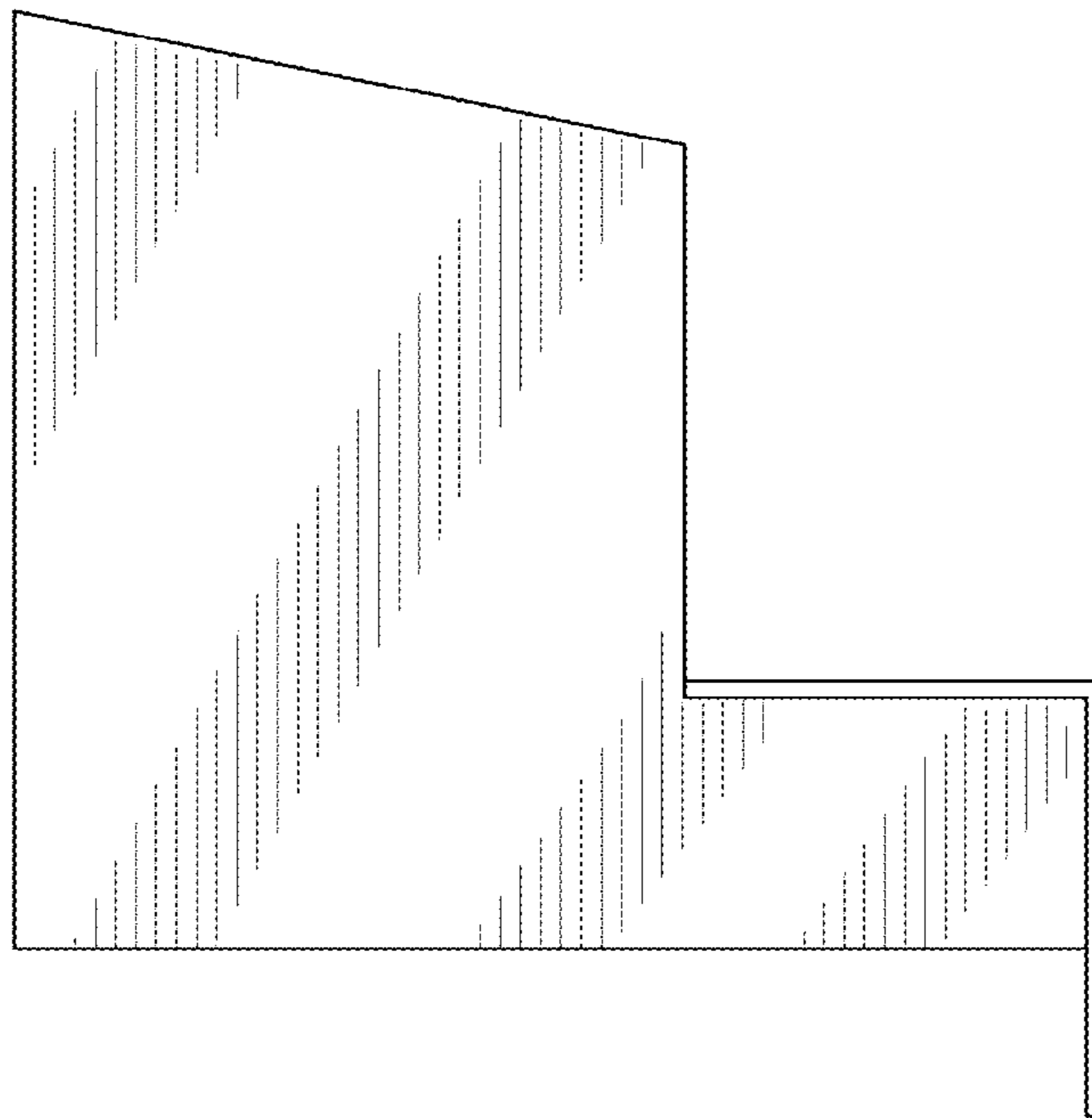

FIG. 5

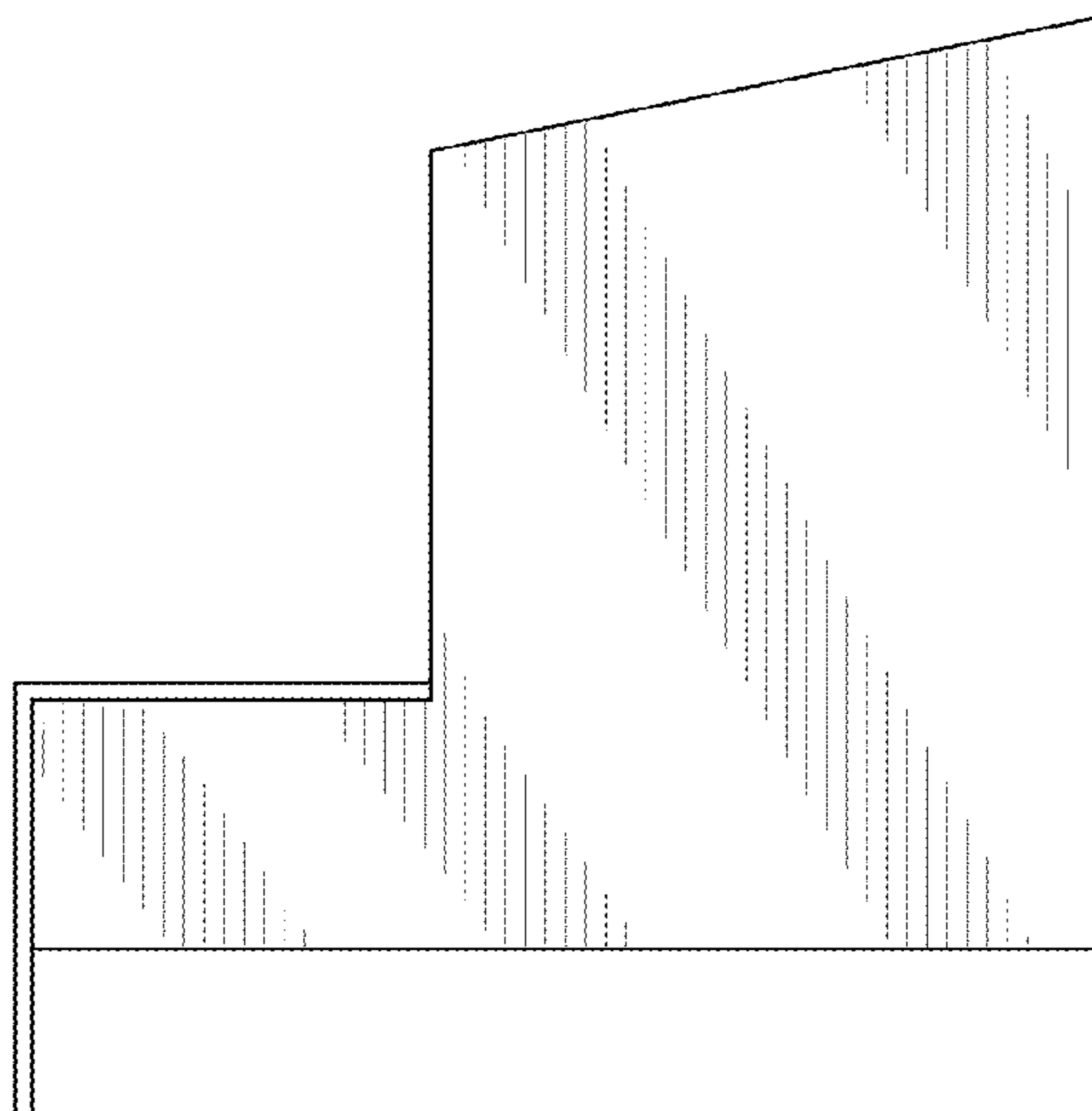

FIG. 6

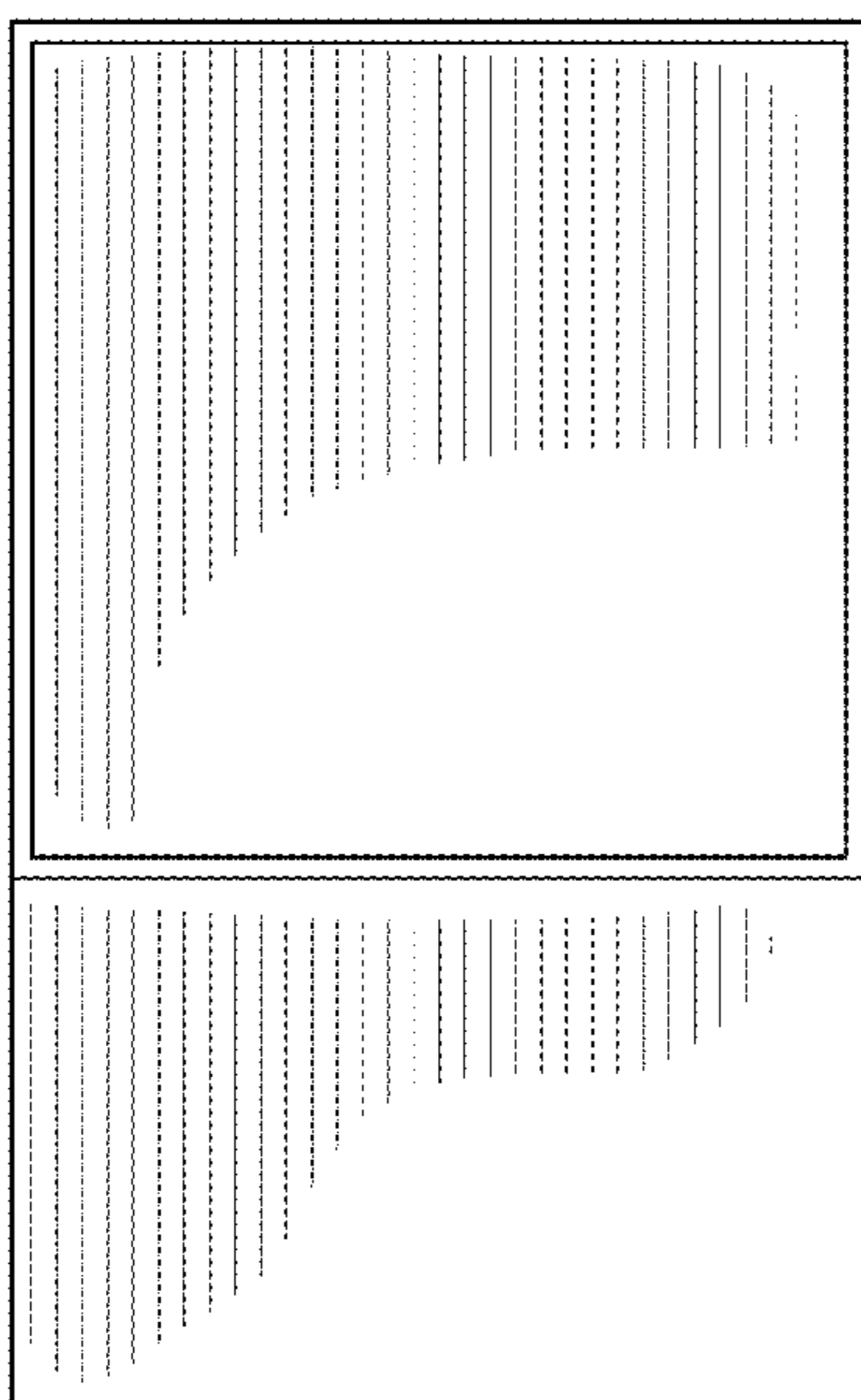

FIG. 7

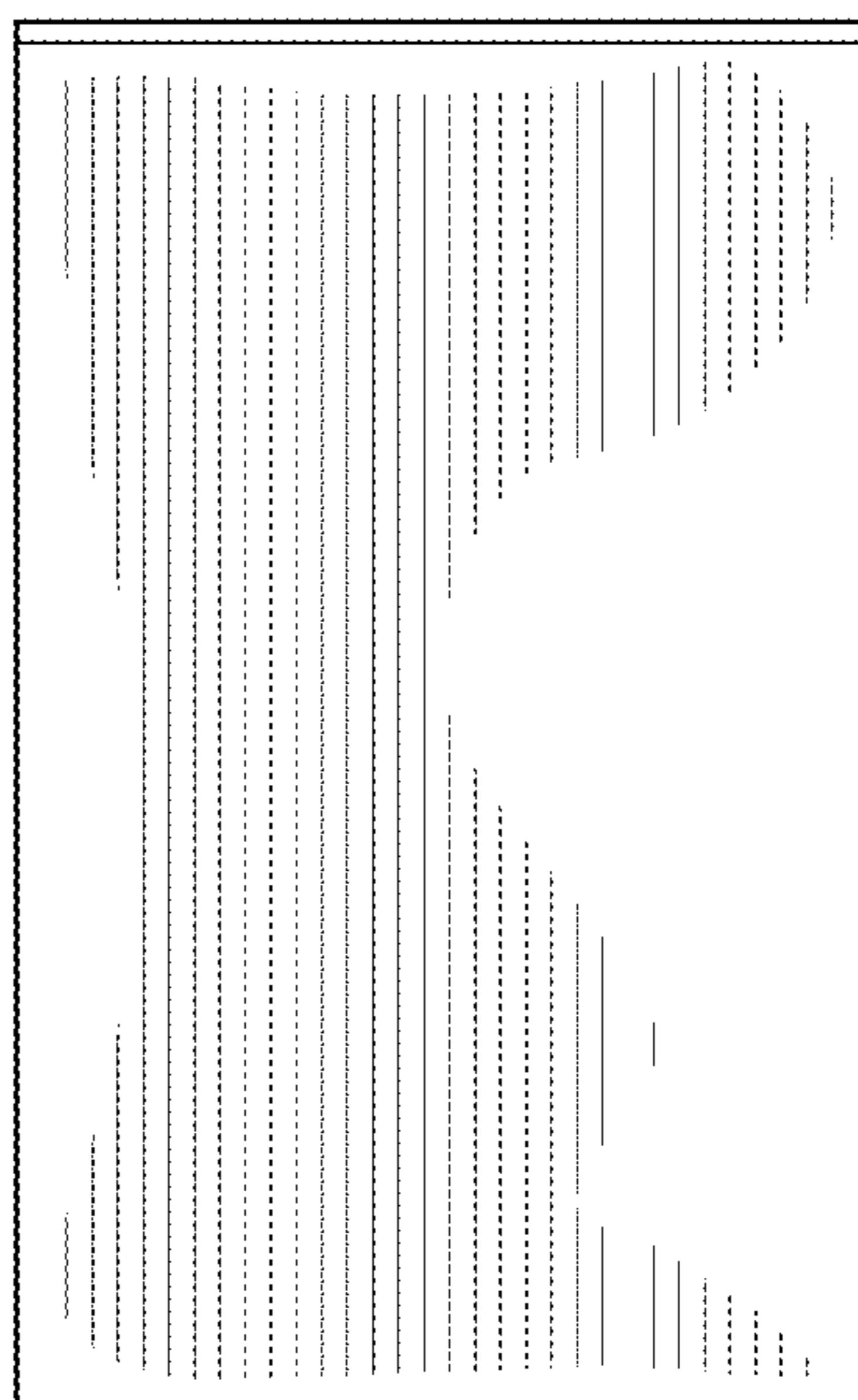

FIG. 8