



US00D754965S

(12) **United States Design Patent**
Bottram—de Louwre

(10) **Patent No.:** **US D754,965 S**

(45) **Date of Patent:** **** May 3, 2016**

(54) **HOLDER AND CARRIER FOR AN INFANT**

(71) Applicant: **Sandra Cornelia Elisabeth Bottram—de Louwre, Bergeijk (NL)**

(72) Inventor: **Sandra Cornelia Elisabeth Bottram—de Louwre, Bergeijk (NL)**

(**) Term: **14 Years**

(21) Appl. No.: **29/510,453**

(22) Filed: **Nov. 28, 2014**

(30) **Foreign Application Priority Data**

Sep. 9, 2014 (EP) 002534271

(51) **LOC (10) Cl.** **03-99**

(52) **U.S. Cl.**
USPC **D3/214**

(58) **Field of Classification Search**
USPC D3/213–217, 259, 303;
D9/101.1–101.5; 224/158, 159, 160,
224/264, 270
CPC A47D 13/02; A47D 13/025; A45F 3/12;
A45F 5/00
See application file for complete search history.

(56) **References Cited**

U.S. PATENT DOCUMENTS

- D240,567 S * 7/1976 Tatum et al. D3/214
- 4,254,900 A * 3/1981 Wheeler A41B 13/06
224/158
- 4,579,264 A * 4/1986 Napolitano A47D 13/025
224/158
- 5,246,152 A * 9/1993 Dotseth A47D 13/025
224/158
- D363,598 S * 10/1995 Walters D3/213
- D370,996 S * 6/1996 Shimura D3/213
- 5,570,823 A * 11/1996 Lindy A47D 13/025
224/159
- D377,116 S * 1/1997 Shimura D3/213
- D382,092 S * 8/1997 Daly D2/828
- D382,395 S * 8/1997 Korshamn D3/213

- D406,945 S * 3/1999 Callihan D3/201
- D425,696 S * 5/2000 Swanke D3/213
- D429,561 S * 8/2000 Korshamn D3/213
- 6,398,088 B1 * 6/2002 Burke A47D 13/025
224/148.6
- 6,415,969 B1 * 7/2002 Higuchi A47D 13/025
224/159
- 7,070,076 B2 * 7/2006 Bergkvist A47D 13/025
224/160
- D557,493 S * 12/2007 Johnson D3/213
- D611,699 S * 3/2010 Lundh D3/213
- D615,750 S * 5/2010 Jones D3/213
- D623,401 S * 9/2010 Bergkvist D3/213
- D623,402 S * 9/2010 Bergkvist D3/213
- D649,345 S * 11/2011 Bergkvist D3/214
- D653,025 S * 1/2012 Brown D3/213
- D655,494 S * 3/2012 Murray D3/213
- D655,495 S * 3/2012 Sauer D3/214
- D664,351 S * 7/2012 Bergkvist D3/214

(Continued)

OTHER PUBLICATIONS

The Swaddle Swing, Access at URL: <http://www.theswaddleswing.com>, Oct. 7, 2014.

Primary Examiner — John Windmuller

Assistant Examiner — Steven Czyz

(74) *Attorney, Agent, or Firm* — Olive Law Group, PLLC

(57) **CLAIM**

I claim the ornamental design for the holder and carrier for an infant, as shown and described.

DESCRIPTION

FIG. 1 is a perspective view of the holder and carrier for an infant;
FIG. 2 is a front view of the holder and carrier for an infant;
FIG. 3 is a back view of the holder and carrier for an infant;
FIG. 4 is a side view of the holder and carrier for an infant;
FIG. 5 is a side view opposing the side view of FIG. 4 of the holder and carrier for an infant;
FIG. 6 is a top view of the holder and carrier for an infant; and,
FIG. 7 is a bottom view of the holder and carrier for an infant.

1 Claim, 5 Drawing Sheets

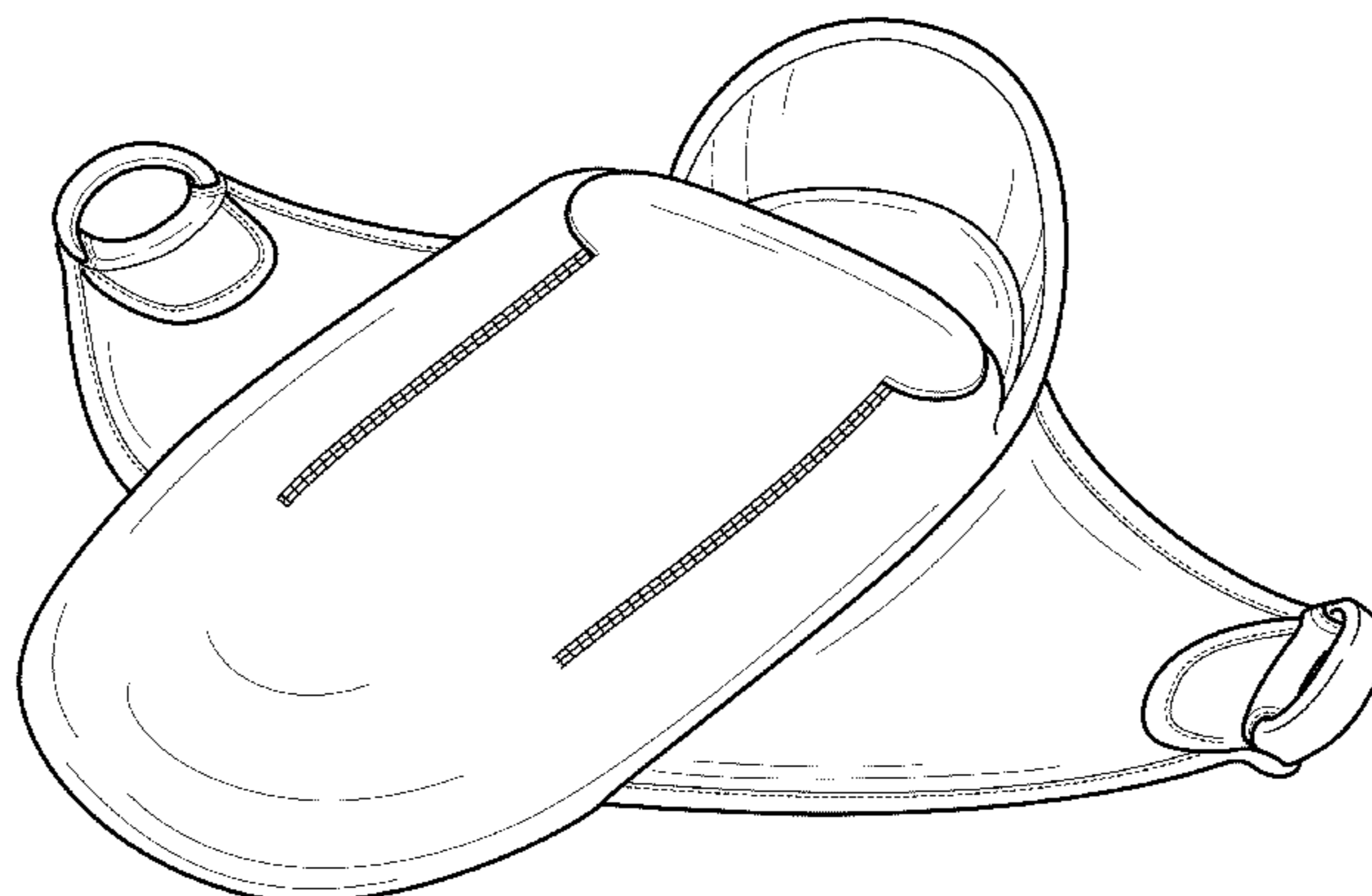

(56)

References Cited

U.S. PATENT DOCUMENTS

| | | | | | | |
|--------------|------|---------|------------|-------|-------------|---------|
| 8,403,189 | B2 * | 3/2013 | Nyberg | | A47D 13/025 | 224/159 |
| D693,569 | S * | 11/2013 | Lehan | | D3/214 | |
| 8,590,757 | B2 * | 11/2013 | Frost | | A47D 13/025 | 224/159 |
| D700,433 | S * | 3/2014 | Ammar | | D2/719 | |
| D711,090 | S * | 8/2014 | Schroder | | D3/213 | |
| D712,134 | S * | 9/2014 | Gunter | | D3/214 | |
| D714,045 | S * | 9/2014 | Stave | | D3/213 | |
| D733,419 | S * | 7/2015 | Wikner | | D3/214 | |
| 2002/0011503 | A1 * | 1/2002 | Hwang | | A47D 13/025 | 224/160 |
| 2004/0149790 | A1 * | 8/2004 | Kassai | | A47D 13/025 | 224/160 |
| 2005/0279785 | A1 * | 12/2005 | Liistro | | A47D 13/025 | 224/160 |
| 2008/0087694 | A1 * | 4/2008 | Meng | | A47D 13/025 | 224/160 |
| 2010/0147910 | A1 * | 6/2010 | Schachtner | | A47D 13/025 | 224/160 |
| 2012/0241487 | A1 * | 9/2012 | Zack | | A47D 13/025 | 224/576 |
| 2012/0298702 | A1 * | 11/2012 | Jung | | A47D 13/025 | 224/158 |

* cited by examiner

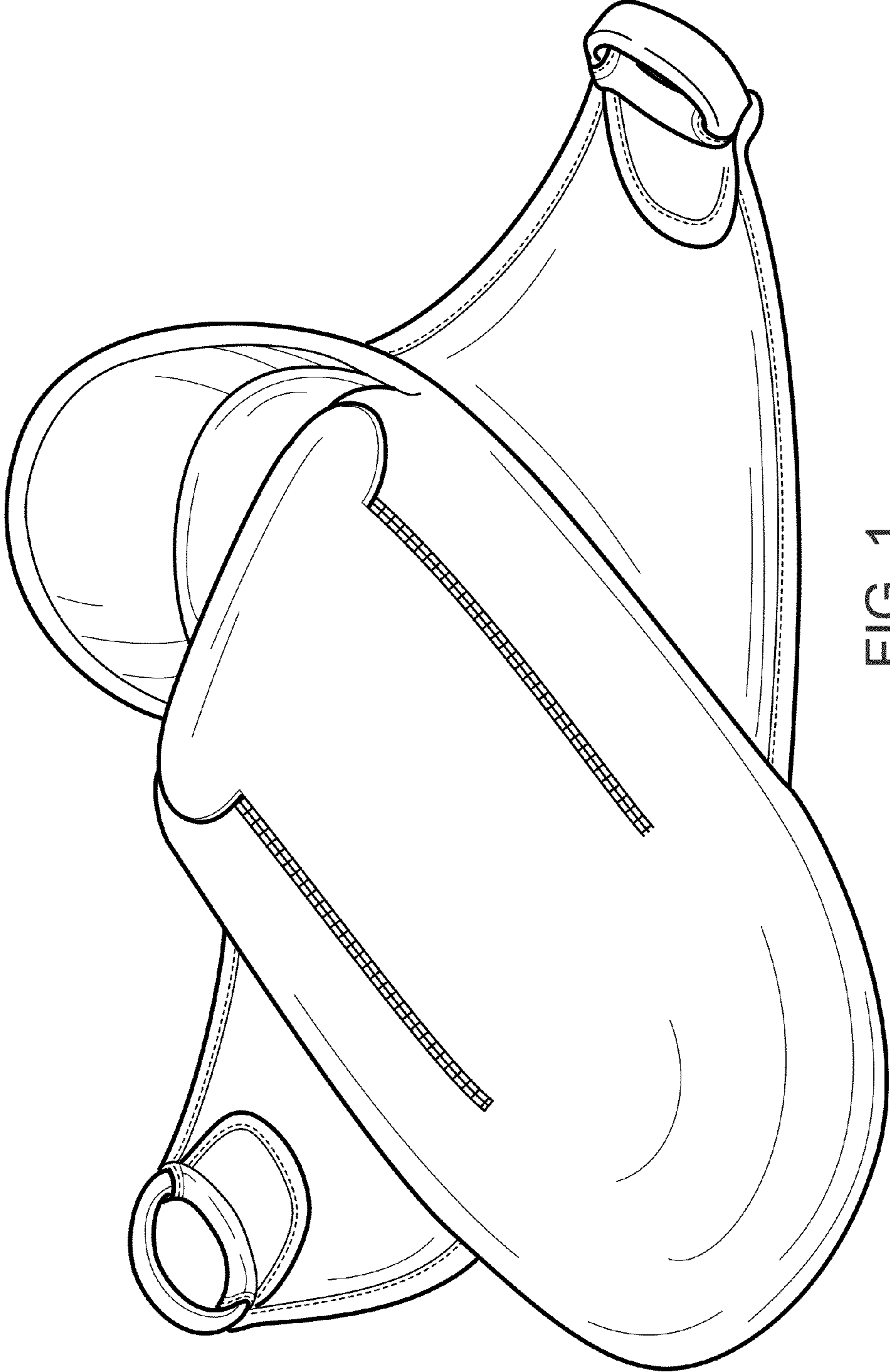

FIG. 1

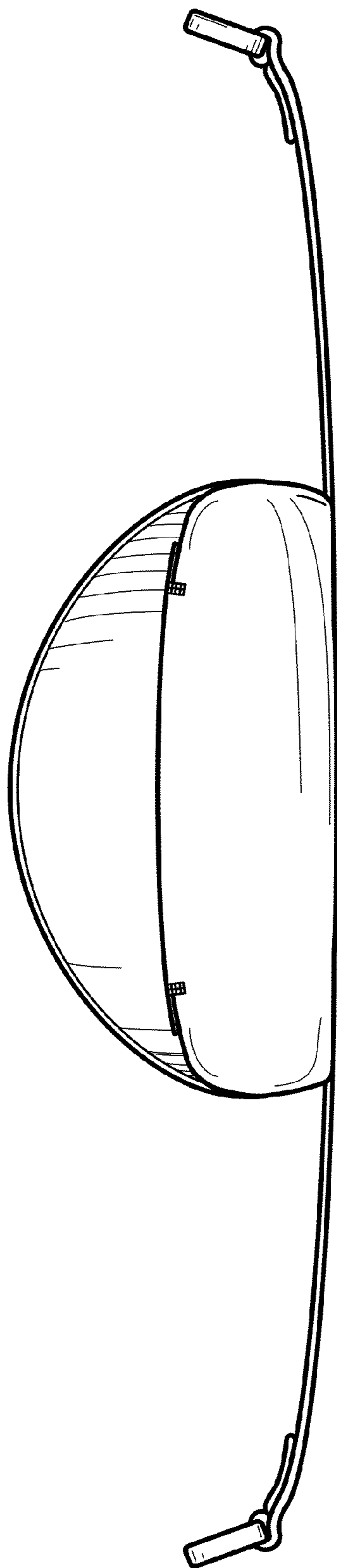

FIG. 2

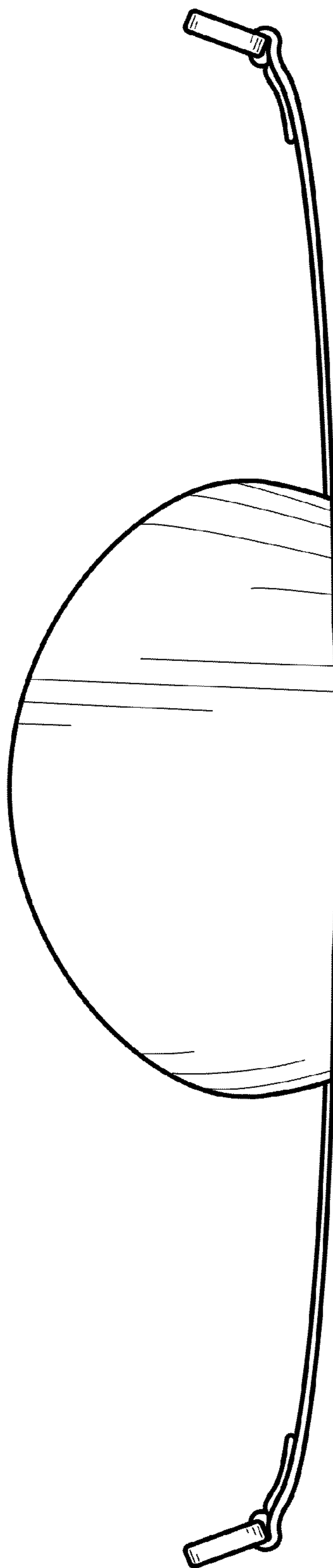

FIG. 3

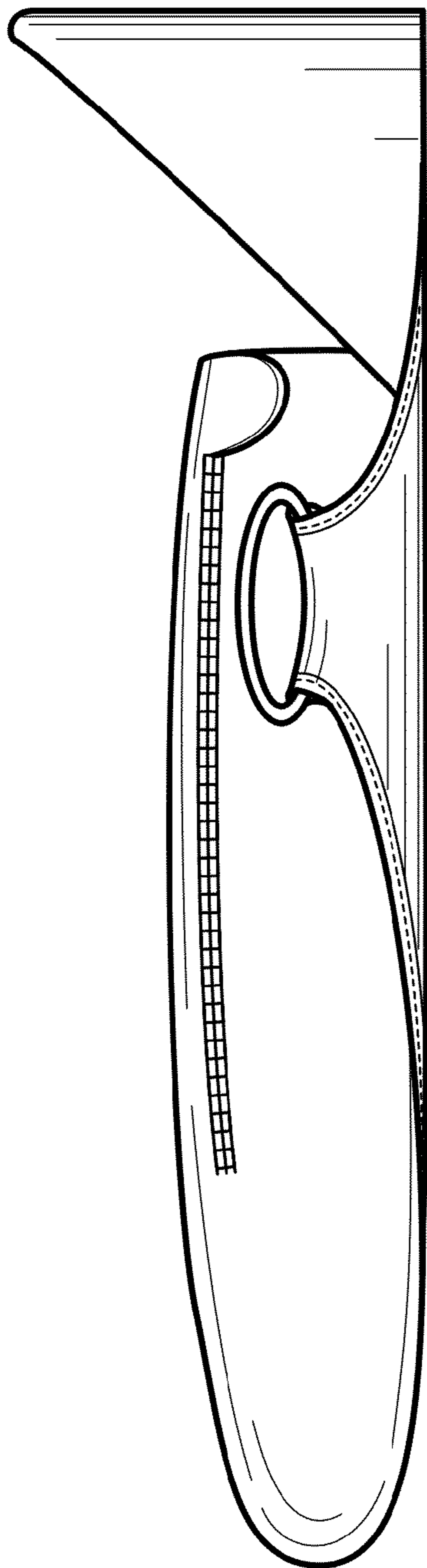

FIG. 4

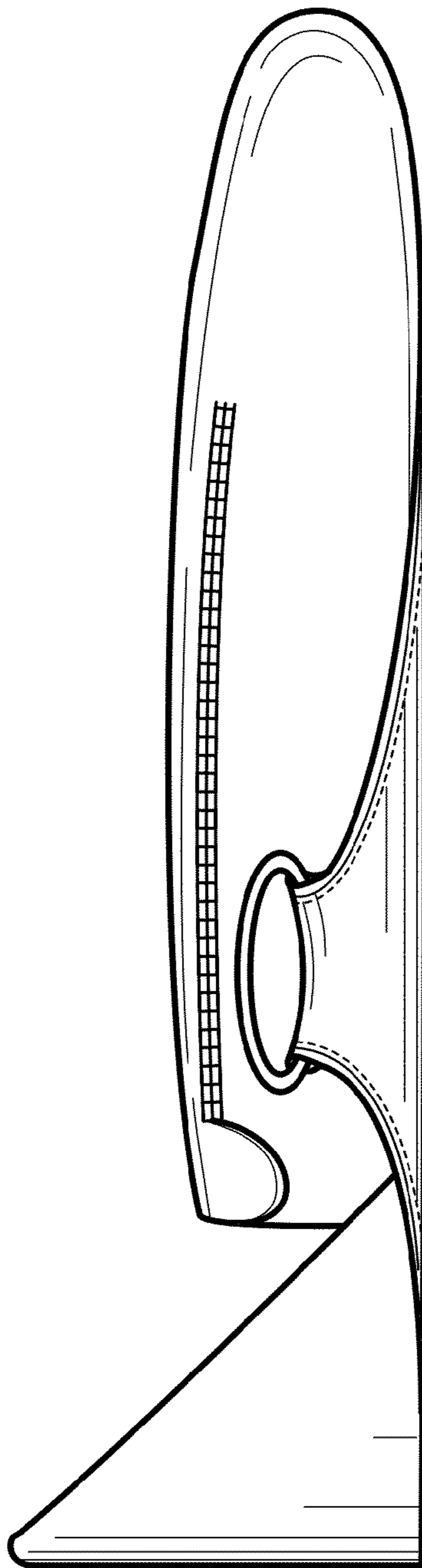

FIG. 5

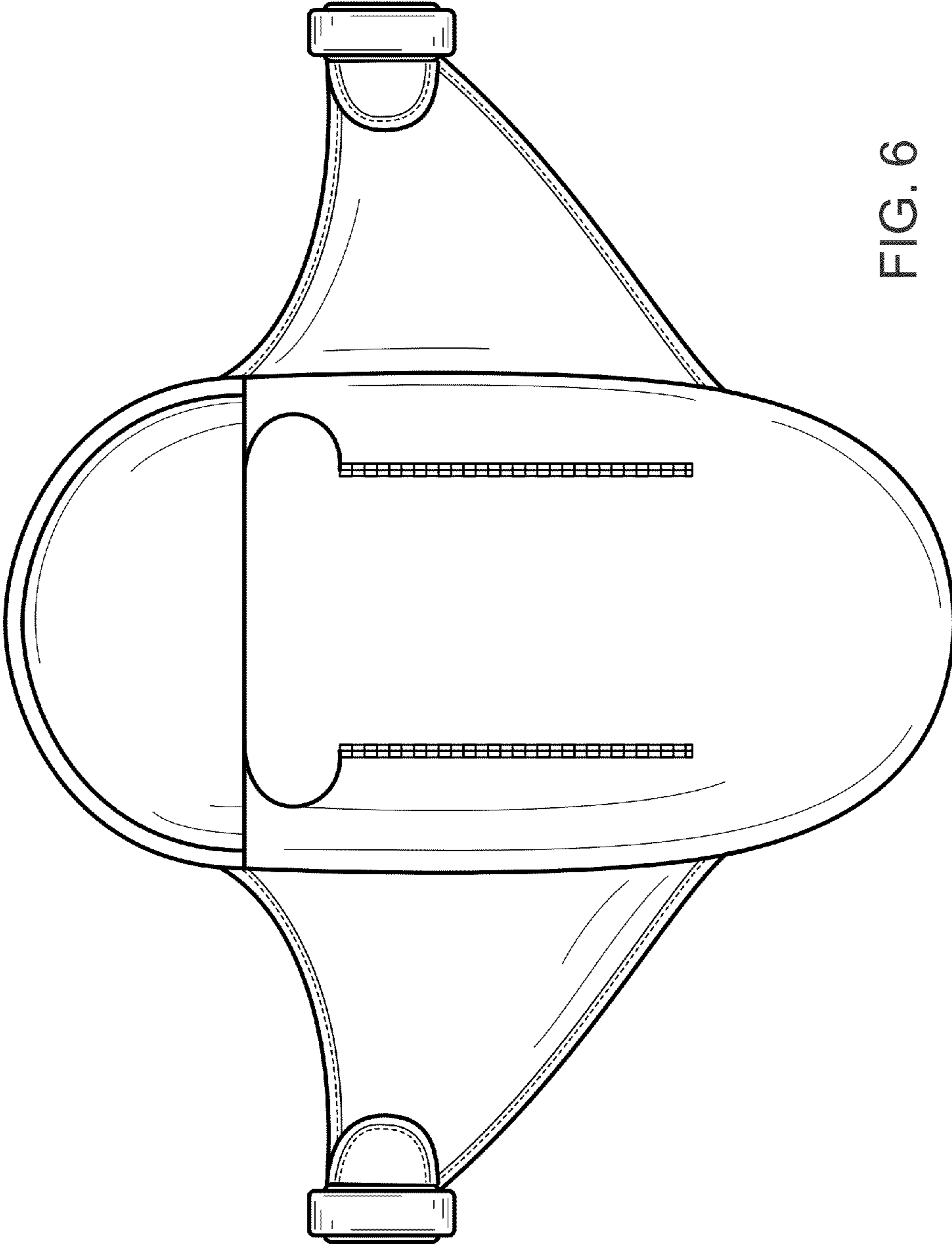

FIG. 6

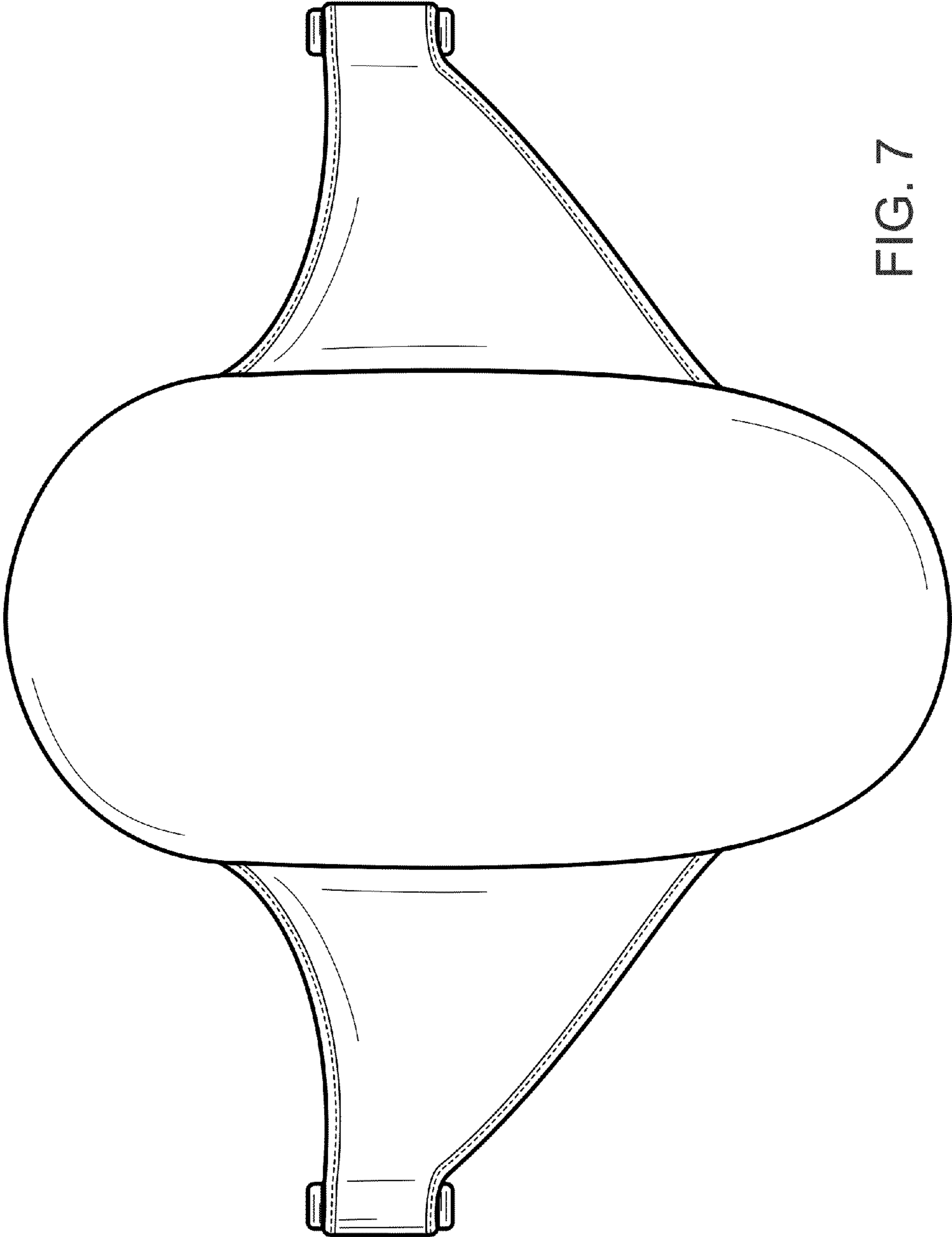

FIG. 7