



US00D754960S

(12) **United States Design Patent**
Fracassi

(10) **Patent No.:** **US D754,960 S**
(45) **Date of Patent:** **** May 3, 2016**

(54) **LACE BAND FOR FOOTWEAR**

FOREIGN PATENT DOCUMENTS

(71) Applicant: **Wolverine World Wide, Inc.**, Rockford, MI (US)

DE 111303 5/1899
DE 496023 3/1930

(72) Inventor: **Eric P. Fracassi**, Grandville, MI (US)

(Continued)

(73) Assignee: **Wolverine World Wide, Inc.**, Rockford, MI (US)

Primary Examiner — Dominic Simone

(74) *Attorney, Agent, or Firm* — Warner Norcross & Judd LLP

(**) Term: **14 Years**

(21) Appl. No.: **29/498,649**

(57) **CLAIM**

The ornamental design for lace band for footwear, as shown and described.

(22) Filed: **Aug. 6, 2014**

(51) **LOC (10) Cl.** **02-99**

(52) **U.S. Cl.**
USPC **D2/972; D2/946; D2/976**

DESCRIPTION

(58) **Field of Classification Search**
USPC D2/902, 906–908, 944, 969, 971–974
CPC .. A43B 13/181; A43B 13/141; A43B 13/186;
A43B 13/188; A43B 23/00; A43B 23/02;
A43B 5/00; A43B 23/26; A43B 1/04; A43B
11/14; A43B 7/00; A43B 3/0078; A43B
23/24; A43C 1/00; A43C 1/04; A43C 1/06;
A43C 7/06

FIG. 1 is a perspective view of the lace band for footwear embodying the new design showing the lace band incorporated into an article of footwear;
FIG. 2 is a perspective view of the lace band for footwear;
FIG. 3 is a front view thereof;
FIG. 4 is a right side view thereof;
FIG. 5 is a left side view thereof;
FIG. 6 is a top view thereof;
FIG. 7 is a perspective view of an alternative embodiment of the lace band for footwear embodying the new design showing the alternative lace band incorporated into an article of footwear;
FIG. 8 is a perspective view of the alternative embodiment of the lace band for footwear;
FIG. 9 is a front view thereof;
FIG. 10 is a right side view thereof;
FIG. 11 is a left side view thereof; and,
FIG. 12 is a top view thereof.
The claimed design extends only through the shaded portions of the drawings. FIGS. 1-12 show features of the lace band for footwear and the article of footwear in phantom lines. These features are shown for environmental purposes, and do not form any part of the claimed design.

See application file for complete search history.

(56) **References Cited**

U.S. PATENT DOCUMENTS

312,675	A	2/1885	Turner	
647,824	A	4/1900	Girtanner	
662,519	A	11/1900	Beach	
743,954	A	11/1903	Thoma	
756,940	A	4/1904	Conger	
886,792	A	5/1908	Gayton	
1,028,598	A	6/1912	Papp	
1,146,934	A	7/1915	Gleeson	
1,255,616	A *	2/1918	Koppe A43B 23/26 36/54
1,340,503	A	5/1920	Schopper	
1,531,410	A	3/1925	Osterholt	
1,624,564	A	4/1927	Shetzline	

(Continued)

1 Claim, 8 Drawing Sheets

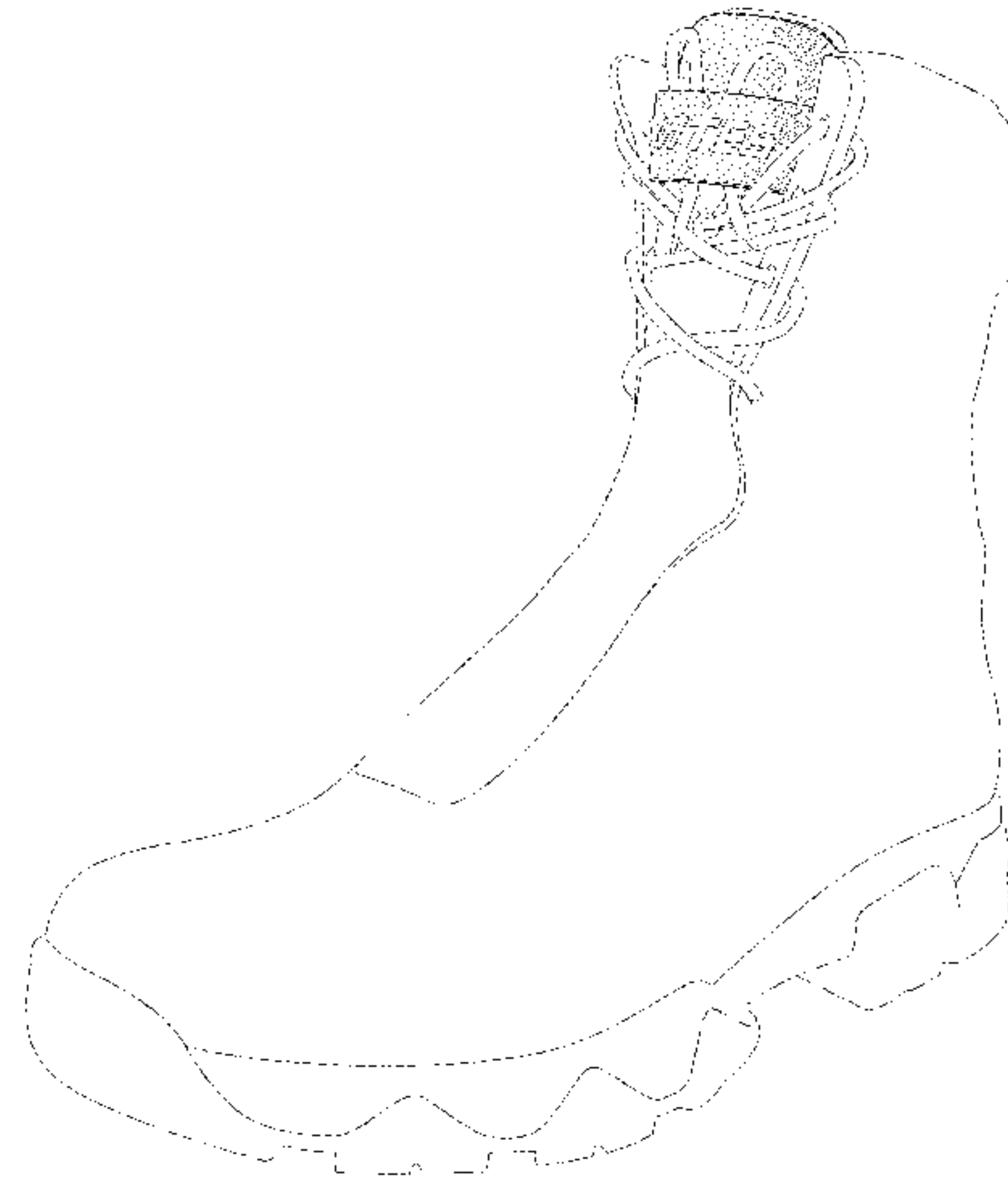
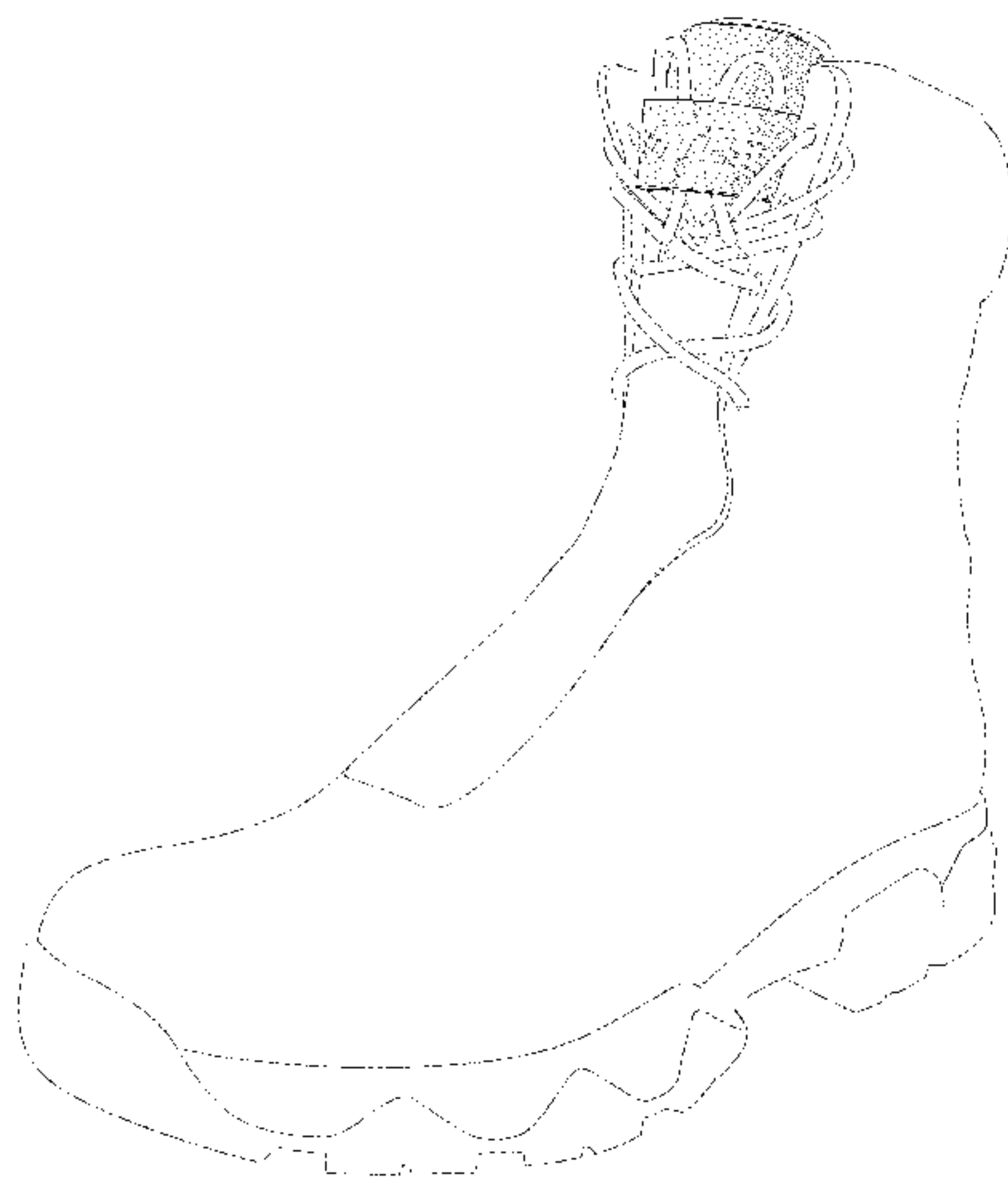

(56)

References Cited

U.S. PATENT DOCUMENTS

1,876,263 A 9/1932 Pittroff
 1,879,475 A 9/1932 Poon
 2,244,031 A 6/1941 Teehan
 2,305,552 A 12/1942 Nyhagen
 2,650,399 A 9/1953 Torelli
 2,983,011 A 5/1961 Winchester
 3,066,370 A 12/1962 Epstein
 3,176,362 A 4/1965 Tames
 3,500,508 A 3/1970 Bennett
 3,631,613 A 1/1972 Brettell
 3,845,575 A 11/1974 Boden
 4,290,172 A 9/1981 Burton
 4,291,439 A 9/1981 Riti
 4,372,060 A 2/1983 Adamik
 4,485,529 A 12/1984 Blum
 4,545,138 A 10/1985 Blum
 4,553,293 A 11/1985 Blum
 4,630,383 A 12/1986 Gamm
 4,766,682 A * 8/1988 Malloy, III A43B 3/0078
 36/132
 4,780,936 A 11/1988 Brecher
 4,805,321 A 2/1989 Tonkel
 4,879,787 A 11/1989 Walls
 4,949,437 A 8/1990 Anderson
 4,955,150 A 9/1990 Fagan
 5,165,190 A 11/1992 Smyth
 5,170,573 A 12/1992 Clinch
 5,293,675 A 3/1994 Shai
 5,402,589 A 4/1995 Lubrani et al.
 5,467,511 A 11/1995 Kubo

5,477,593 A 12/1995 Leick
 5,566,474 A 10/1996 Leick et al.
 D376,041 S * 12/1996 Nitz D2/946
 D385,102 S * 10/1997 Avar D2/946
 5,724,679 A 3/1998 Hans
 5,778,500 A 7/1998 Illingworth
 5,903,959 A 5/1999 Leonardi
 5,913,483 A 6/1999 Polk
 5,924,177 A 7/1999 Jongejan
 5,943,793 A 8/1999 Clements
 5,979,028 A 11/1999 Hicks et al.
 6,026,548 A 2/2000 Jackson
 6,038,792 A 3/2000 Hauter
 6,178,606 B1 1/2001 Glendon
 6,240,607 B1 6/2001 McCrary
 6,247,214 B1 6/2001 Hyde
 6,338,186 B1 1/2002 Kleinmann
 6,408,542 B1 * 6/2002 Shepherd A43B 5/00
 36/114
 6,473,999 B2 11/2002 Fellouhe
 6,532,688 B2 3/2003 Bouvier
 6,823,610 B1 11/2004 Ashley
 D650,983 S * 12/2011 Waldman D2/946

FOREIGN PATENT DOCUMENTS

DE 8810872 4/1989
 EP 0629793 12/1994
 EP 0923886 6/1999
 FR 744906 4/1933
 FR 2490467 3/1982
 FR 2607678 6/1988

* cited by examiner

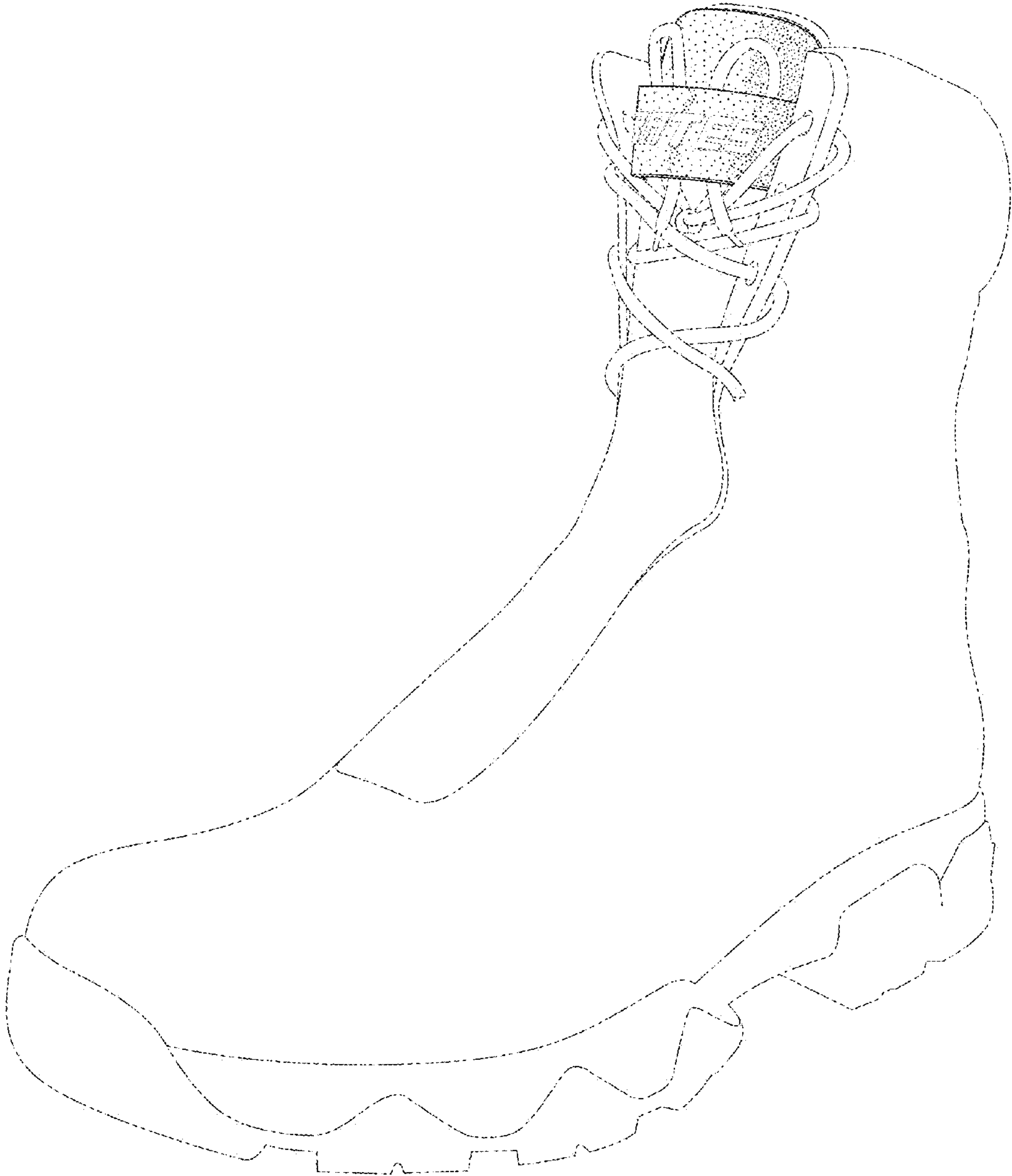

Fig. 1

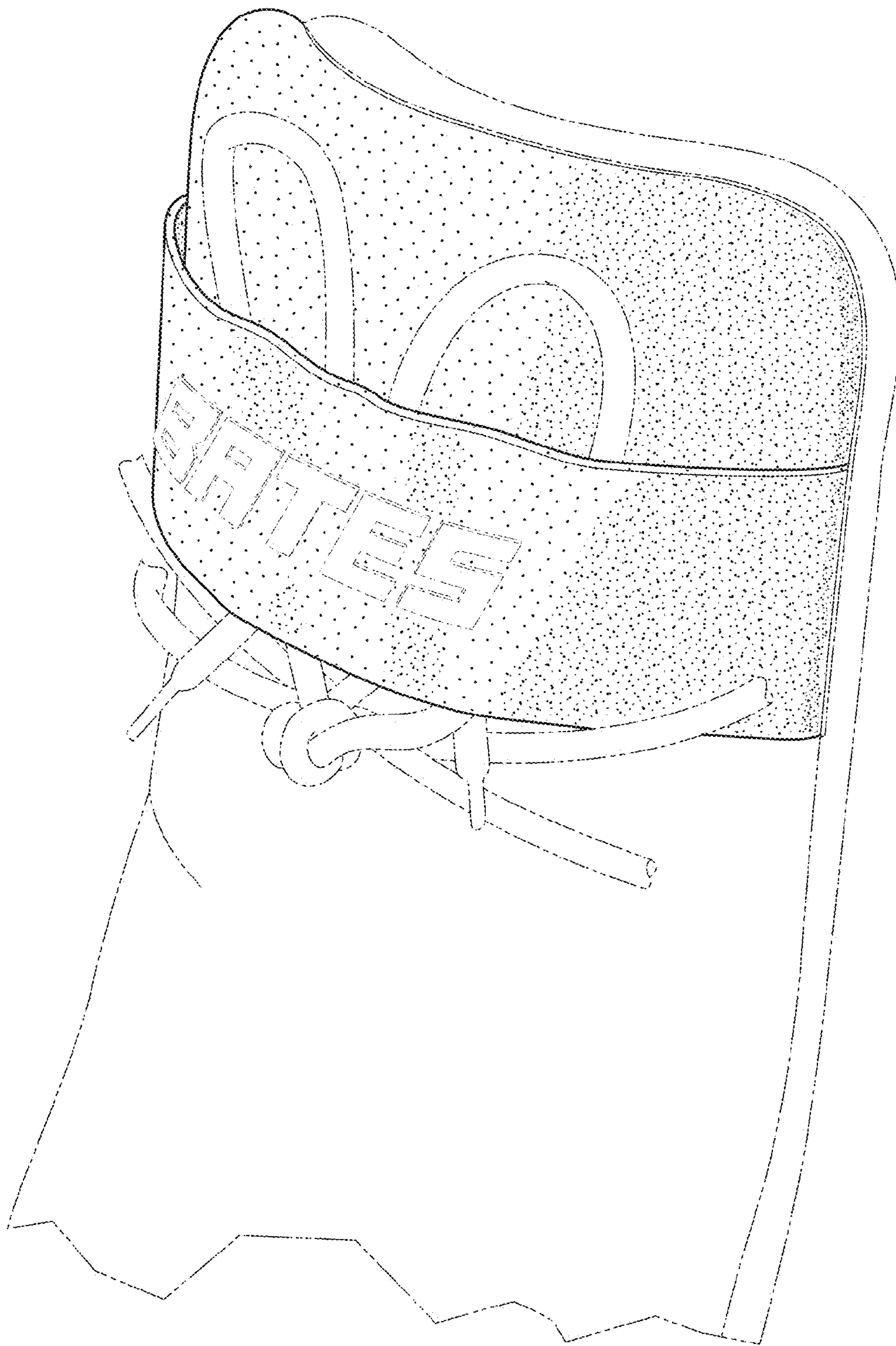

Fig. 2

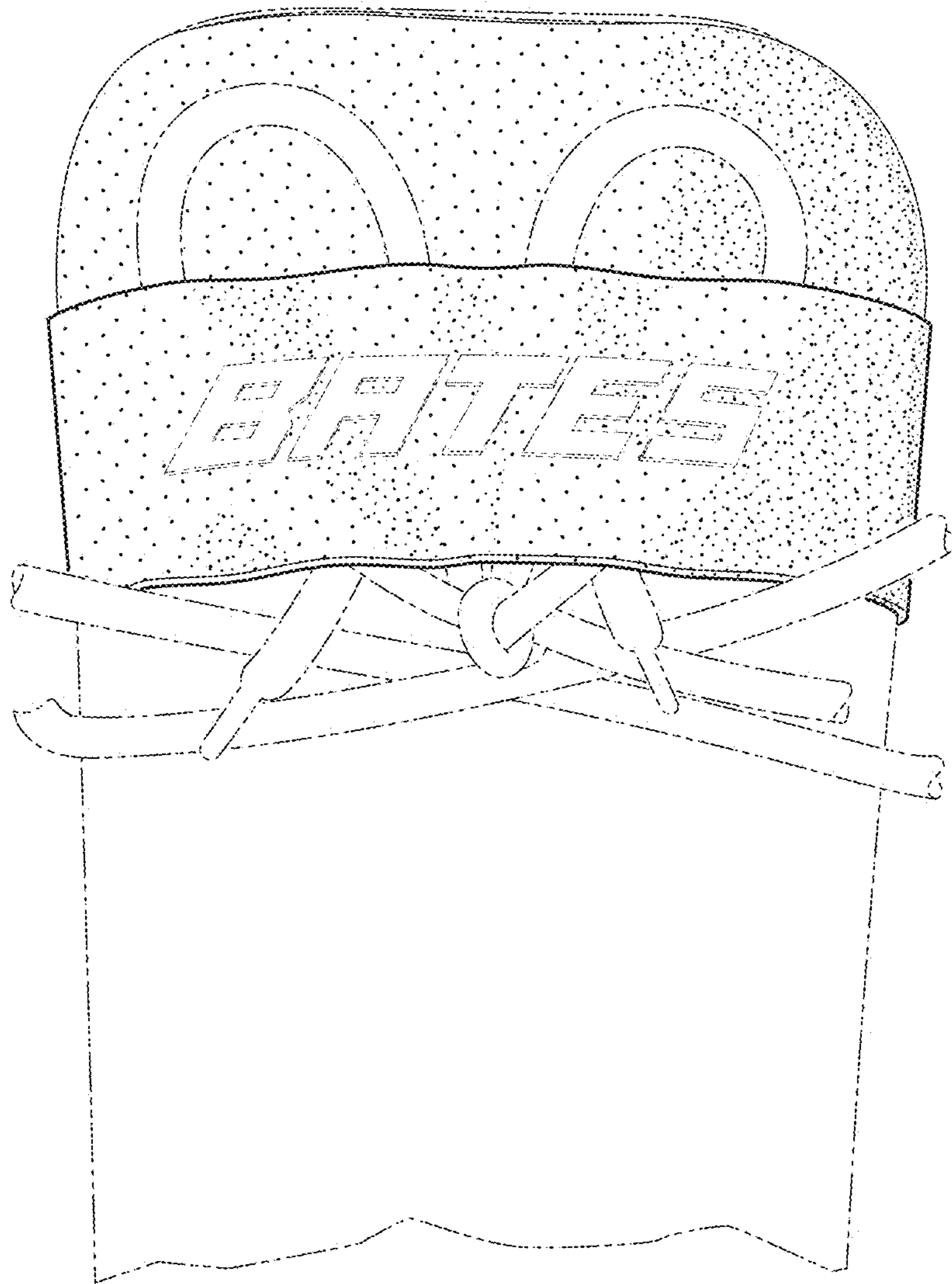

Fig. 3

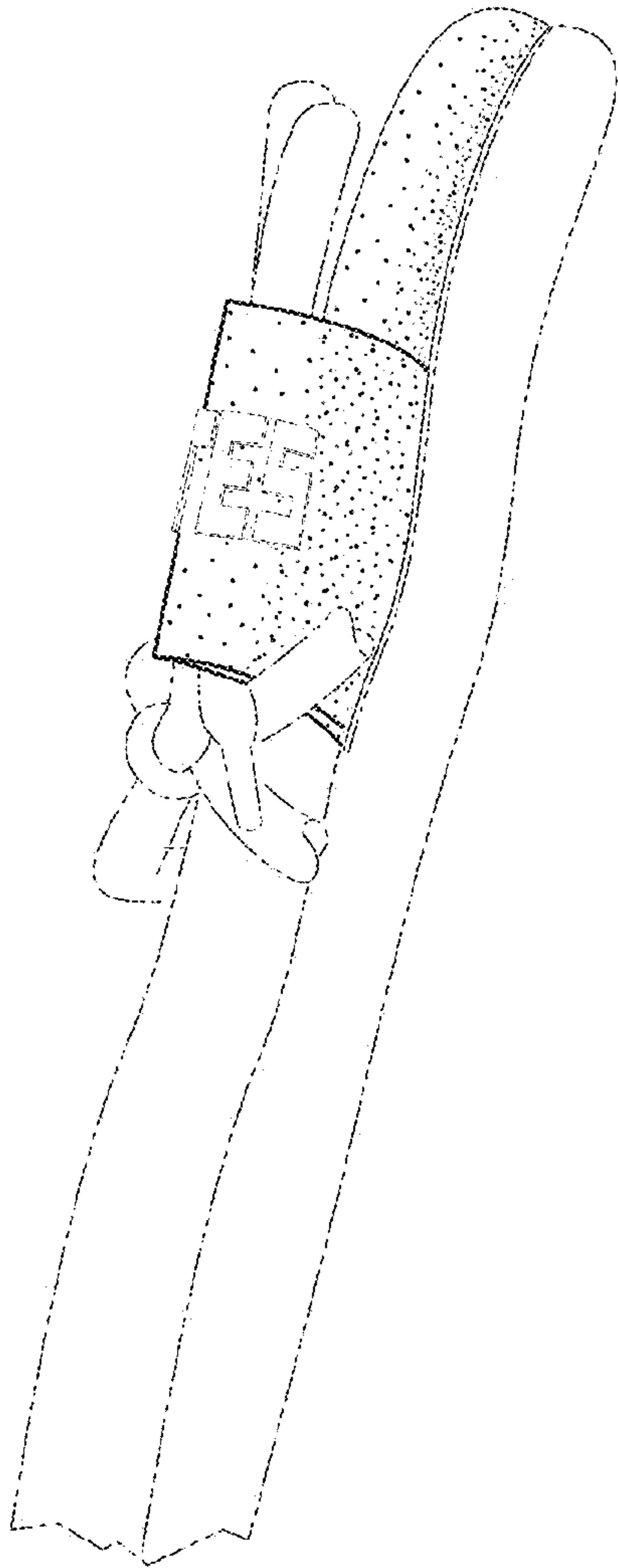

Fig. 4

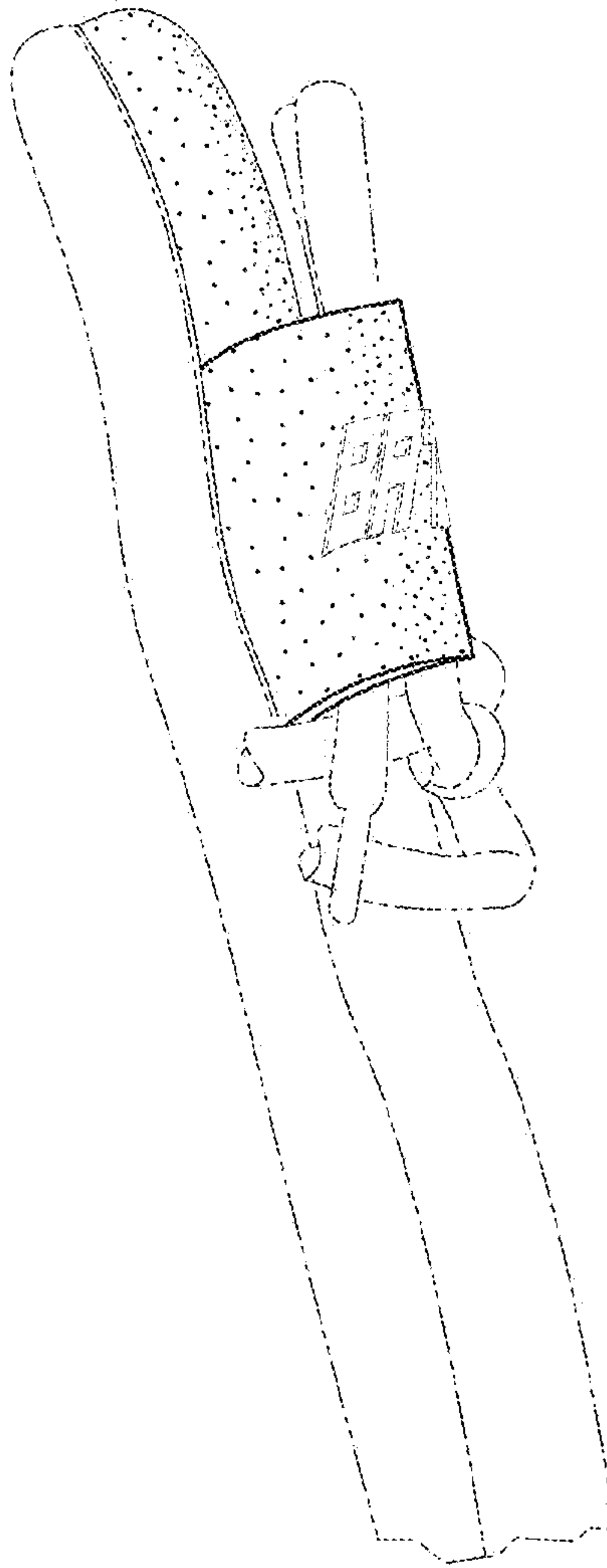

Fig. 5

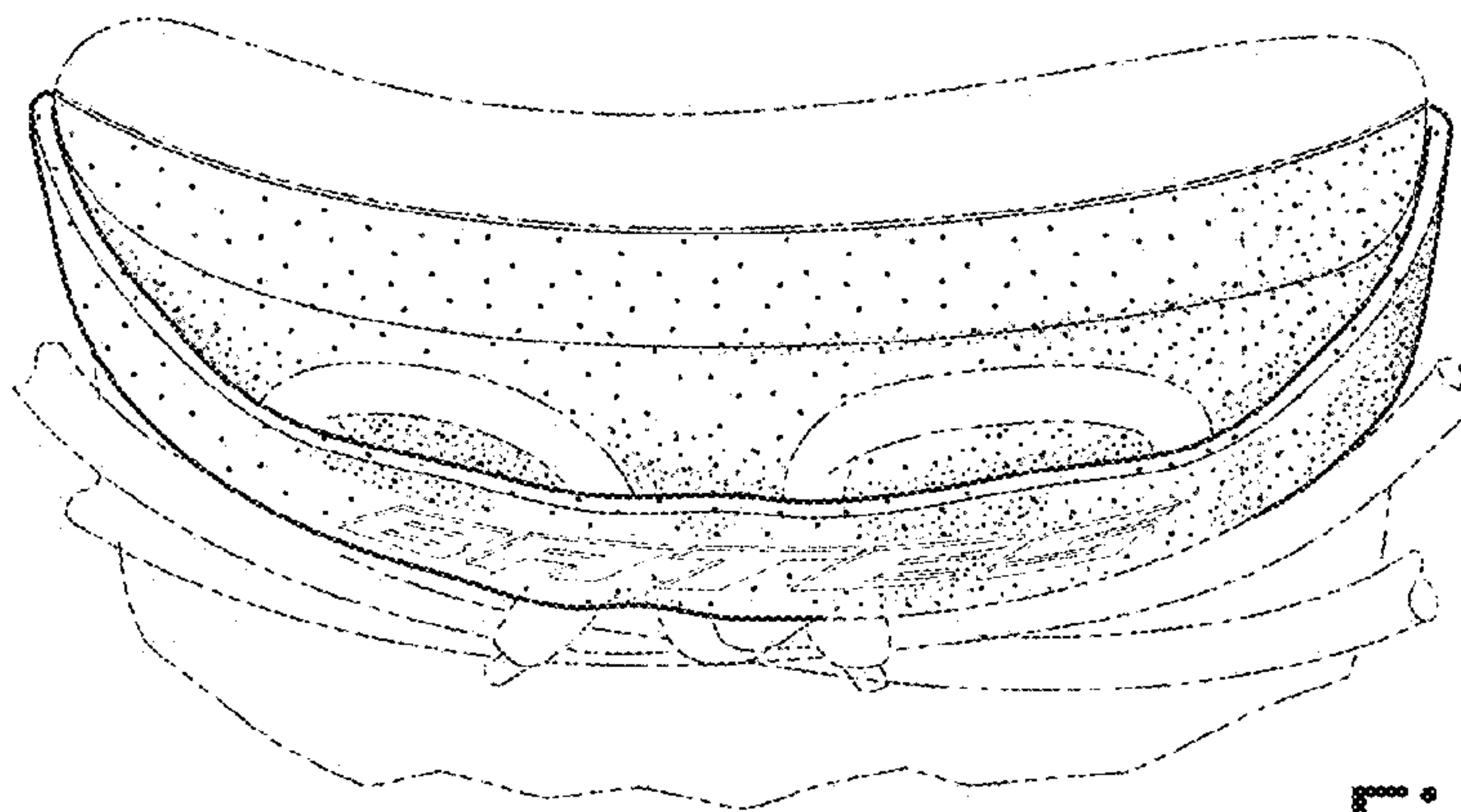

Fig. 6

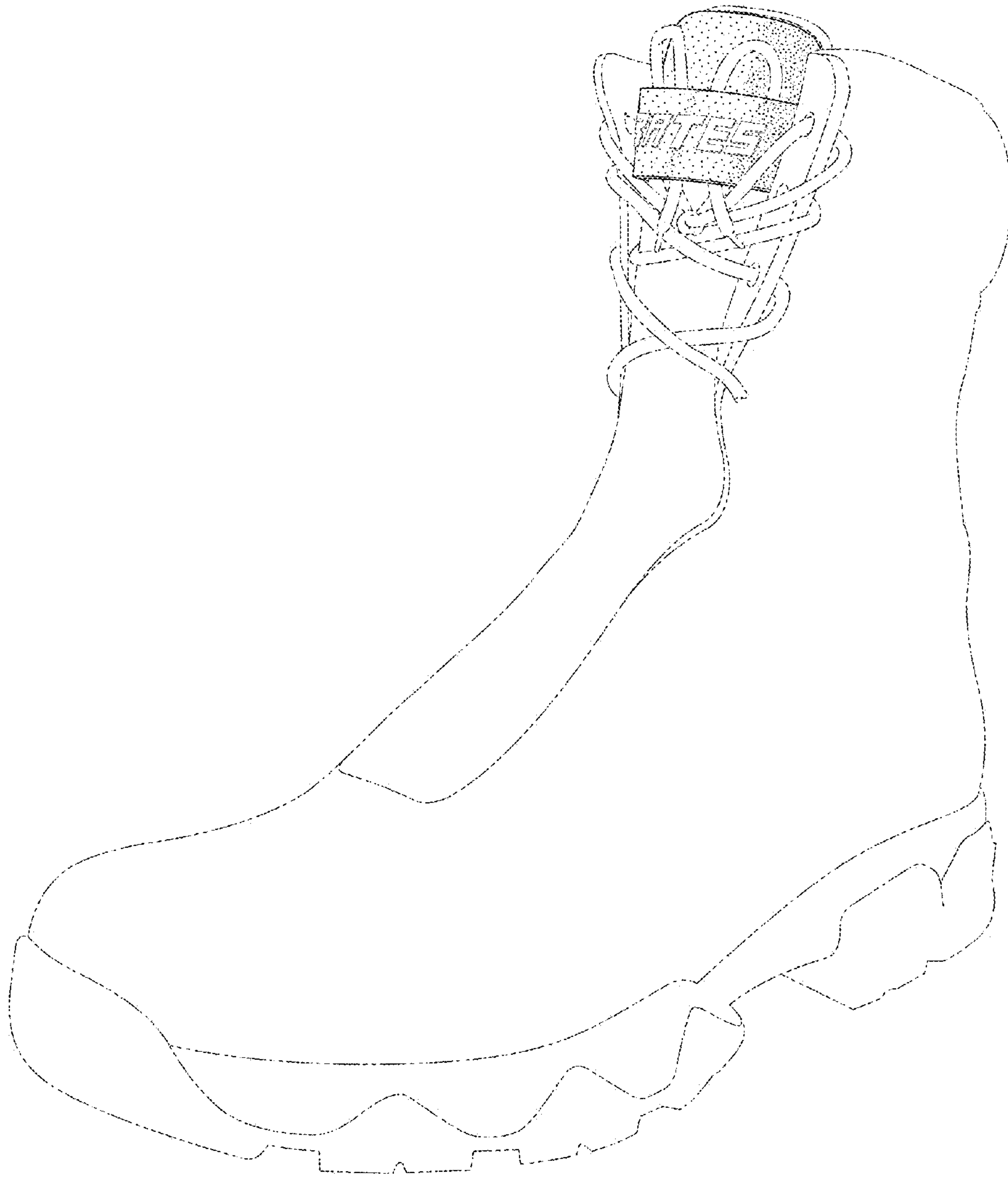

Fig. 7

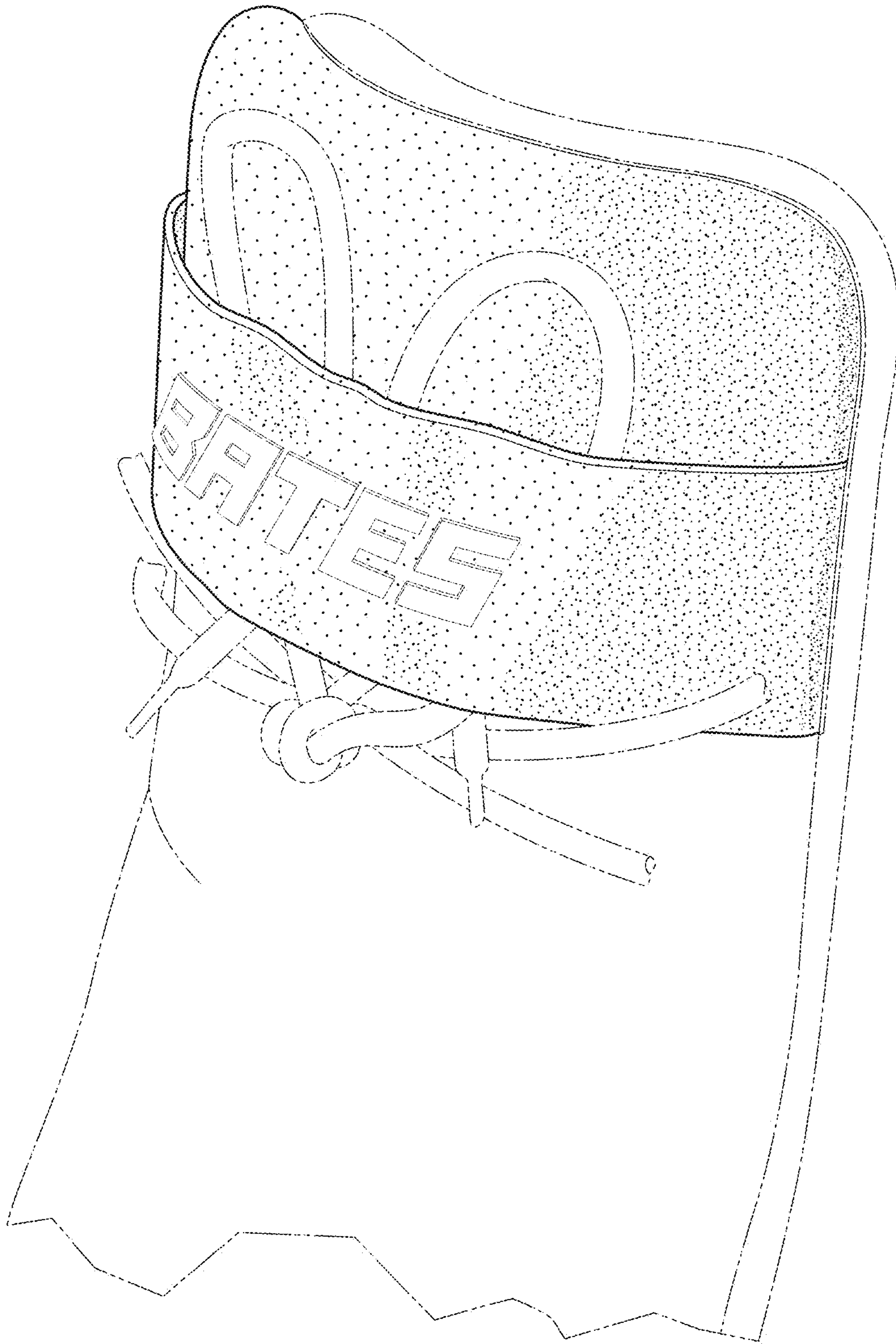

Fig. 8

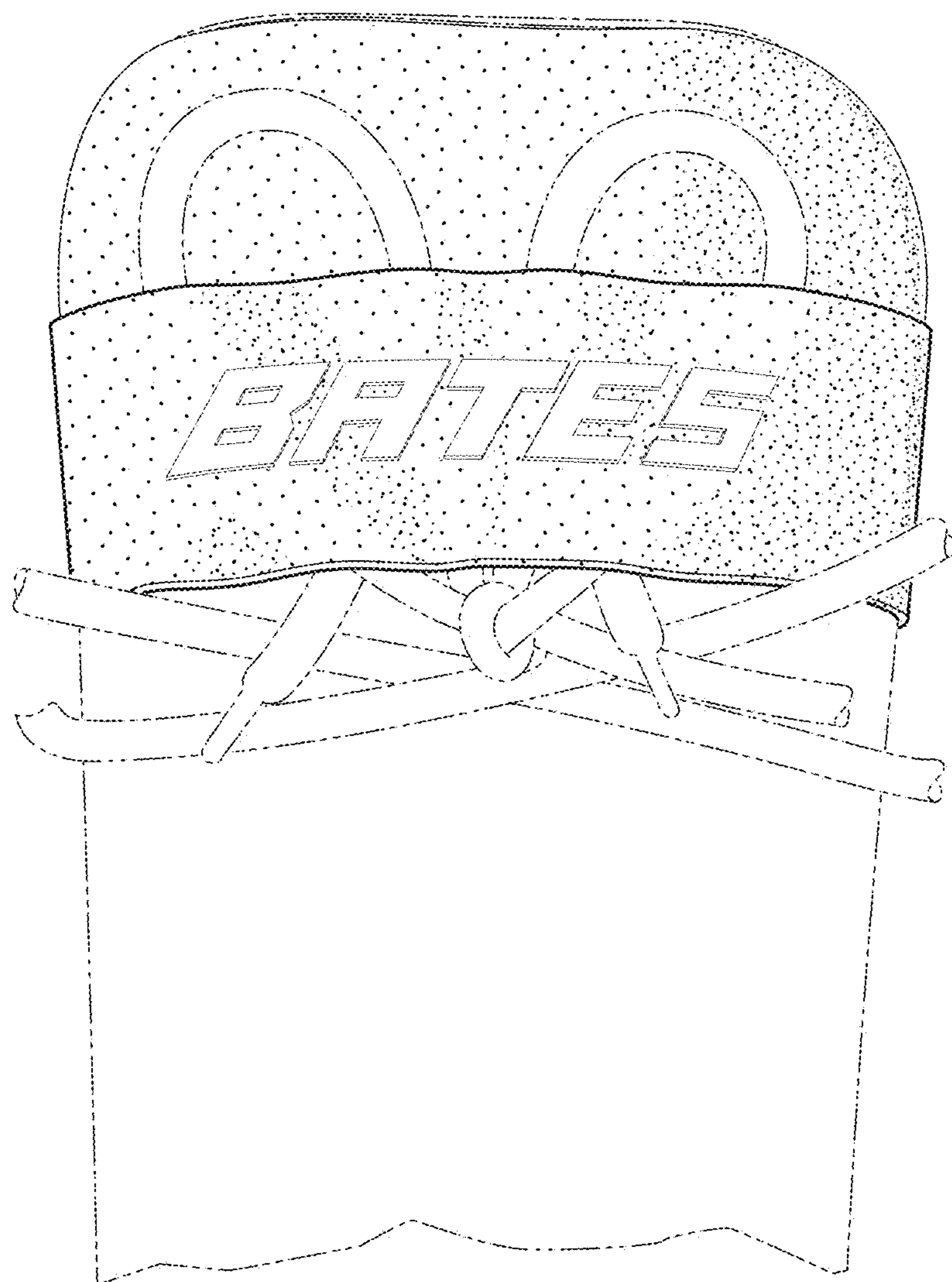

Fig. 9

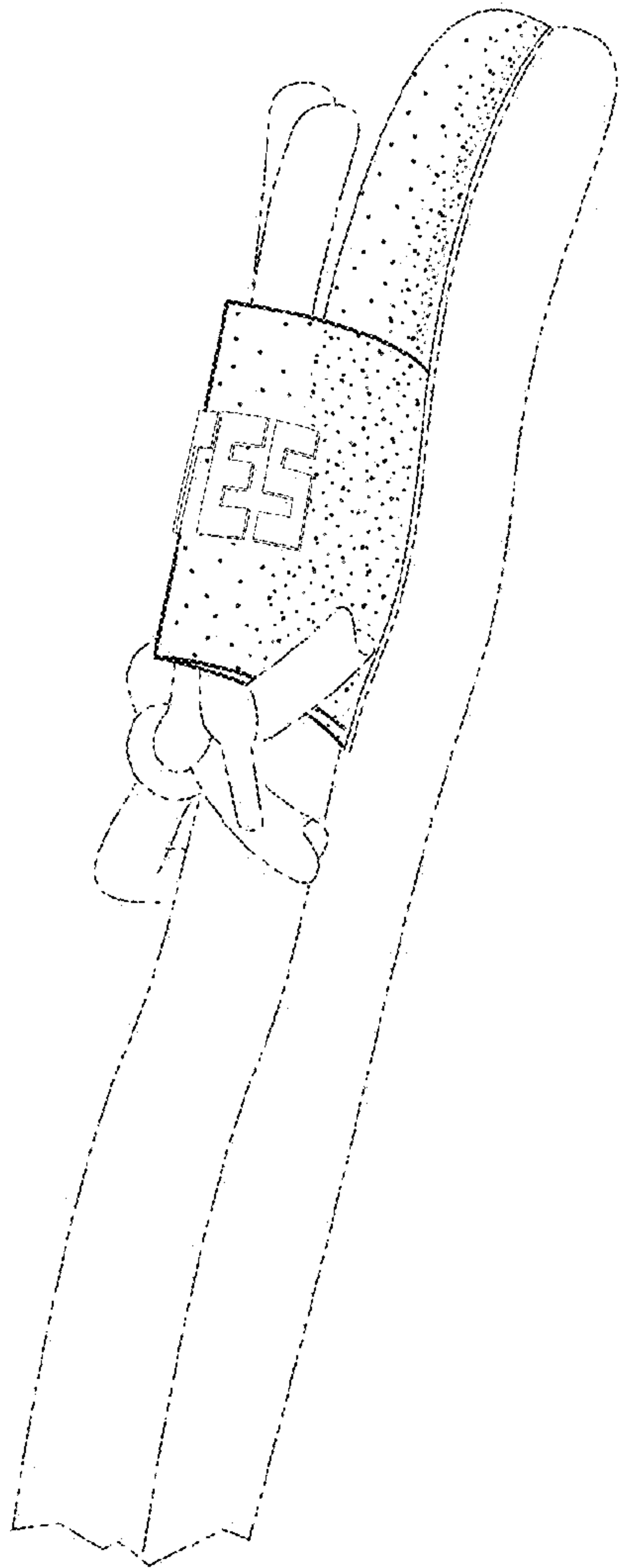

Fig. 10

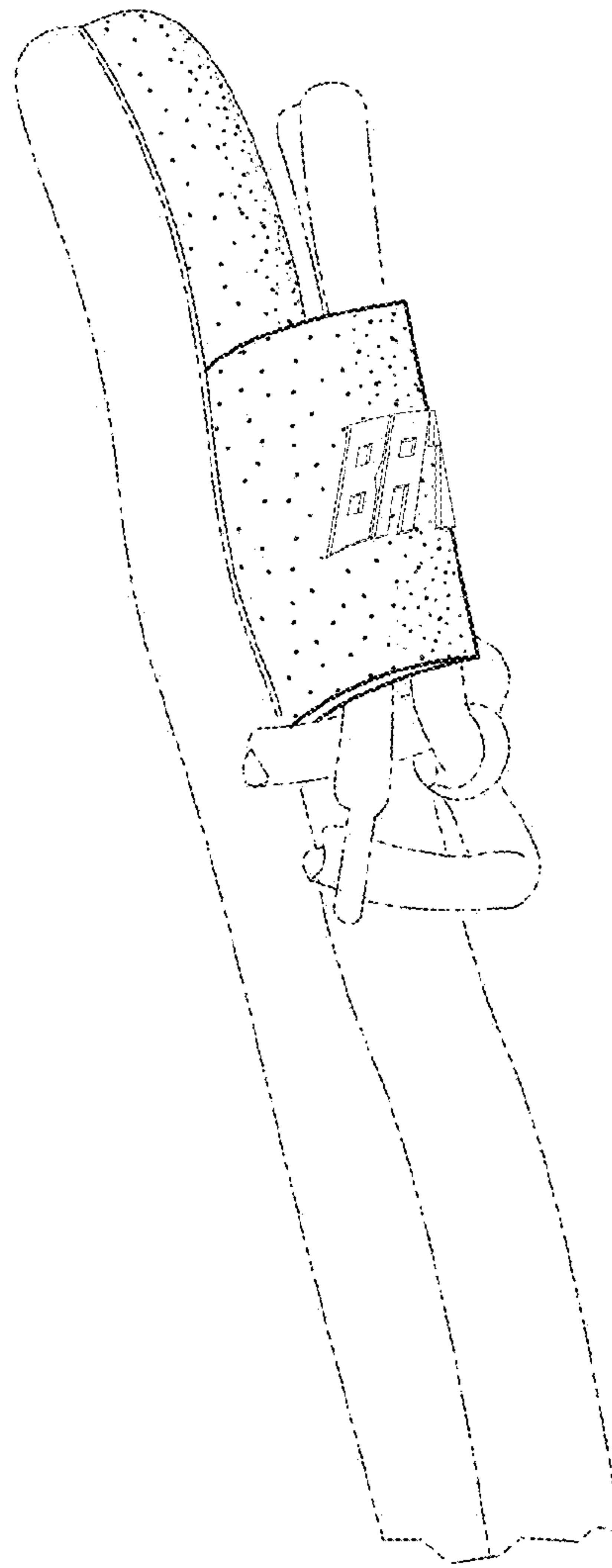

Fig. 11

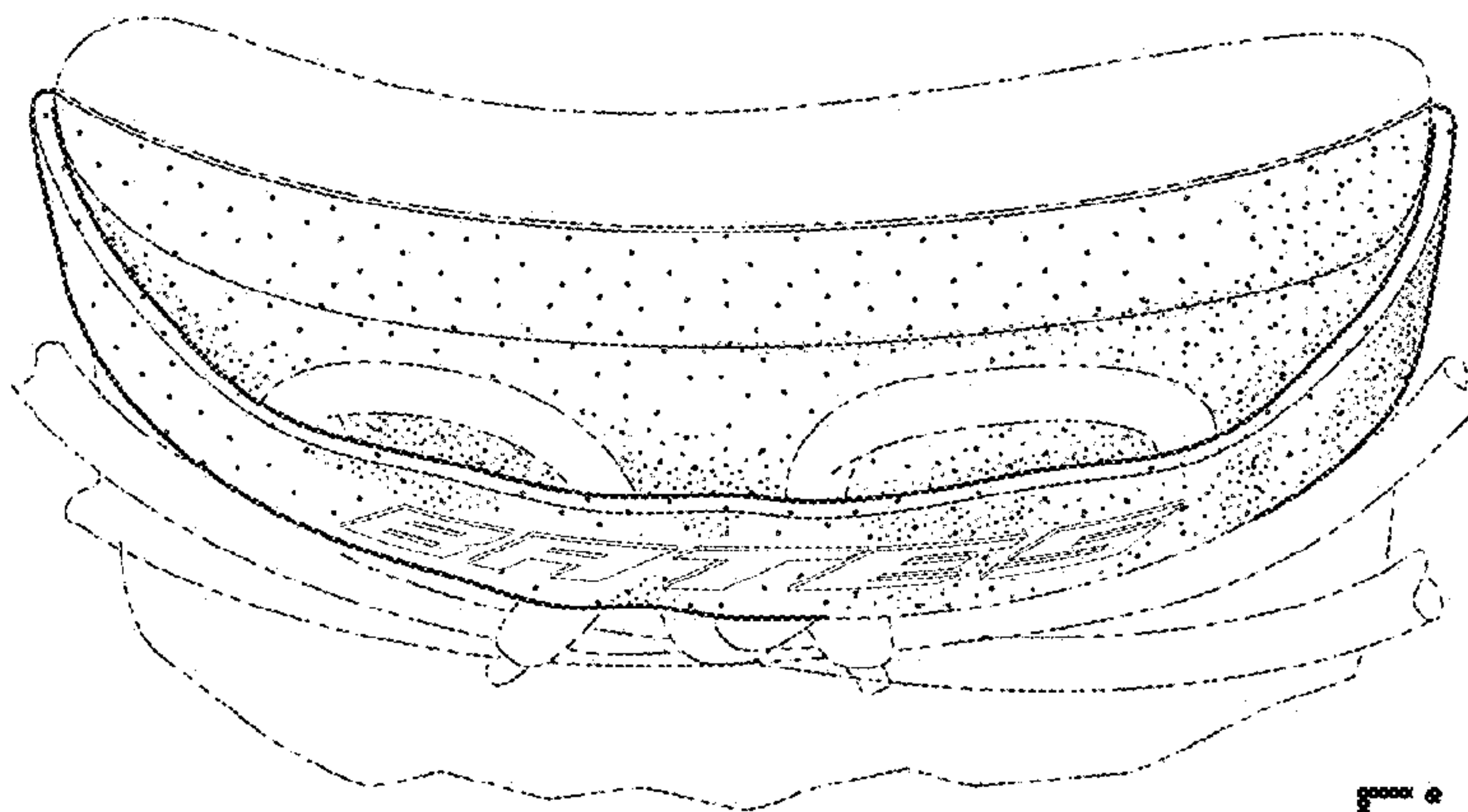

Fig. 12