



US00D754865S

(12) **United States Design Patent**  
**Hägg**

(10) **Patent No.:** **US D754,865 S**  
(45) **Date of Patent:** **\*\* Apr. 26, 2016**

(54) **MUSCLE STIMULATOR**

(71) Applicant: **MYoroface AB**, Hudiksvall (SE)

(72) Inventor: **Mary Hägg**, Forsa (SE)

(73) Assignee: **MYOROFACE AB** (SE)

(\*\*) Term: **14 Years**

(21) Appl. No.: **29/466,932**

(22) Filed: **Sep. 13, 2013**

(30) **Foreign Application Priority Data**

Mar. 15, 2013 (EM) ..... 002203141-0001

(51) **LOC (10) Cl.** ..... **24-02**

(52) **U.S. Cl.**  
USPC ..... **D24/200**

(58) **Field of Classification Search**  
USPC ..... D24/200, 194, 176, 181, 195; D8/383;  
D13/147; D29/108; 24/130; 433/38,  
433/36; 73/12.01  
CPC ..... F16G 11/10; A16C 9/0006; G01M 7/08  
See application file for complete search history.

(56) **References Cited**

**U.S. PATENT DOCUMENTS**

D26,071 S *	9/1896	Howland	.....	D8/383
D32,194 S *	2/1900	Conger	.....	D8/383
656,431 A *	8/1900	Stewart	.....	24/130
2,657,461 A *	11/1953	Sweeney	.....	433/38
D255,268 S *	6/1980	Bernstein	.....	D24/194
4,368,040 A *	1/1983	Weissman	.....	433/36
D300,059 S *	2/1989	Pier	.....	D24/176
4,907,966 A *	3/1990	Kesling	.....	433/37
D328,494 S *	8/1992	Schwendeman et al.	....	D24/176
D367,465 S *	2/1996	Becker	.....	D13/147
D382,965 S *	8/1997	Wagner	.....	D29/108
D406,647 S *	3/1999	Wagner	.....	D24/181
D414,267 S *	9/1999	Calandro, Jr.	.....	D24/194

D445,902 S *	7/2001	Luehne-Porath	.....	D24/194
D473,976 S *	4/2003	Wilkins	.....	D29/108
D492,785 S *	7/2004	Garabito	.....	D24/181
D523,994 S *	6/2006	Manzo	.....	D29/108
D529,615 S *	10/2006	Atz	.....	D24/181
D530,425 S *	10/2006	Carlson	.....	D24/181
D548,402 S *	8/2007	Trodick	.....	D29/108
D554,760 S *	11/2007	Brockhaus et al.	.....	D24/194
D565,185 S *	3/2008	Wilkins	.....	D24/181
D570,549 S *	6/2008	Essig	.....	D29/108
D571,473 S *	6/2008	Wilkins	.....	D24/181

(Continued)

**FOREIGN PATENT DOCUMENTS**

CA	125915	*	4/2009
JP	D1180577	*	7/2003

**OTHER PUBLICATIONS**

Tokaido Karate Mouth Guard, Announced Feb. 2, 2012, [ Site Visited Jul. 29, 2015 ] <http://tokaido-karate.com/en/chranice/34-tokaido-karate-mouth-guard.html>.\*

(Continued)

*Primary Examiner* — John Windmuller  
*Assistant Examiner* — Luqman McNeil  
(74) *Attorney, Agent, or Firm* — Fox Rothschild LLP

(57) **CLAIM**

The ornamental design for a muscle stimulator, as shown and described.

**DESCRIPTION**

FIG. 1 is a front perspective view;  
FIG. 2 is a rear view;  
FIG. 3 is a front view;  
FIG. 4 is a left side view;  
FIG. 5 is a right side view;  
FIG. 6 is a top view; and,  
FIG. 7 is a bottom view.

**1 Claim, 7 Drawing Sheets**

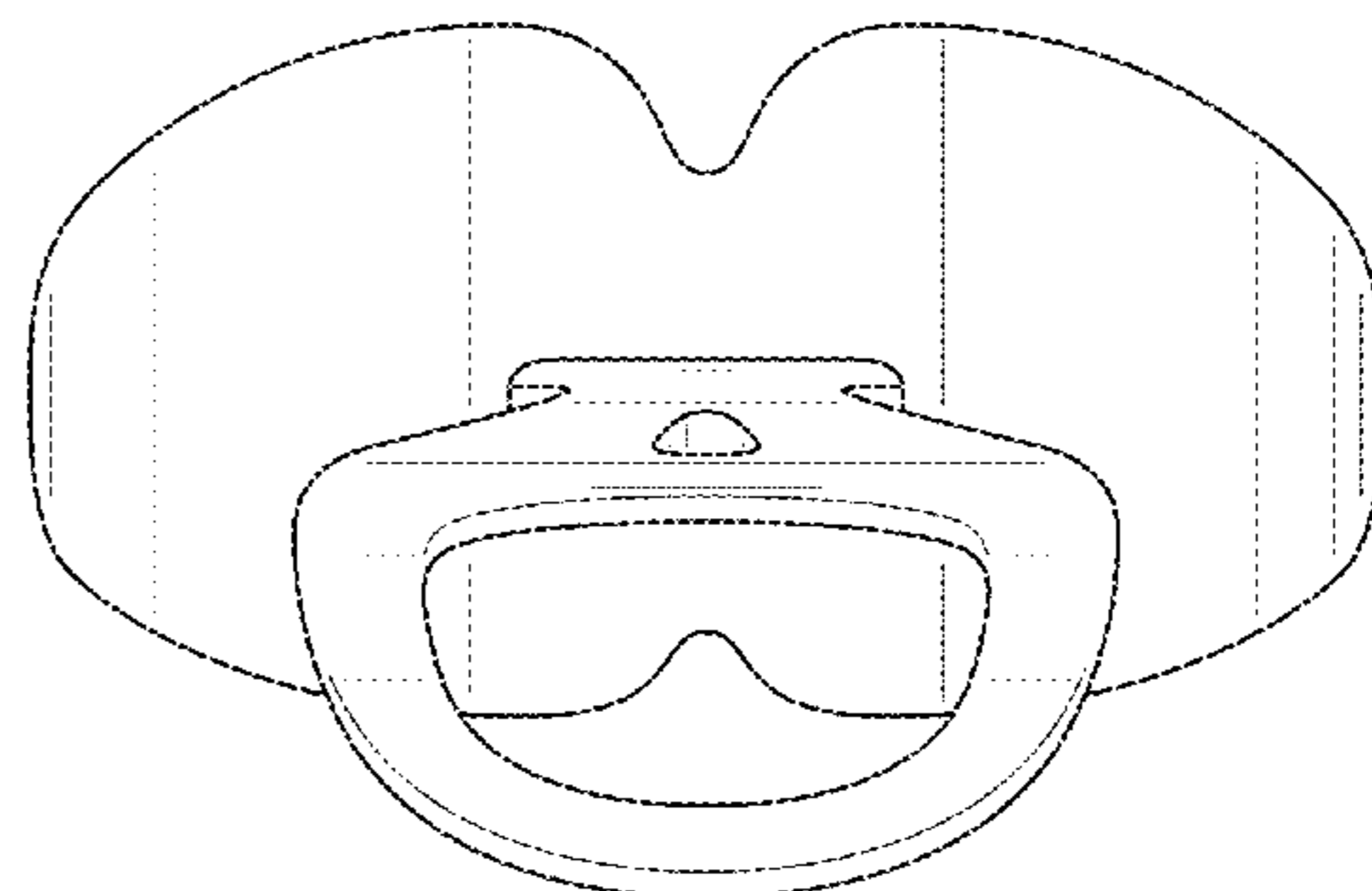
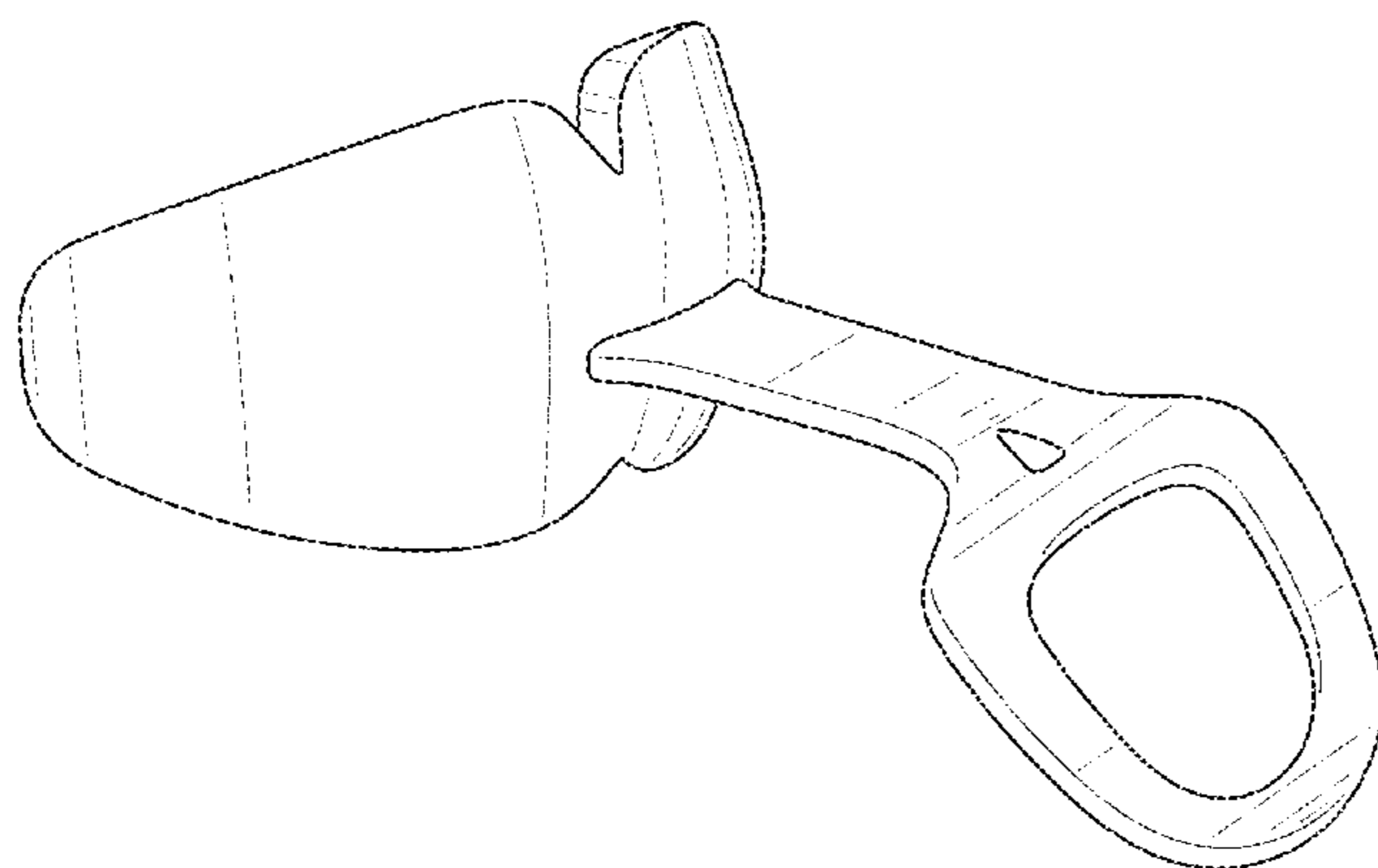

(56)

**References Cited**

U.S. PATENT DOCUMENTS

D572,368 S \* 7/2008 Kliegman et al. .... D24/194  
D584,002 S \* 12/2008 Essig ..... D29/108  
D604,858 S \* 11/2009 Neal ..... D24/195  
D623,357 S \* 9/2010 Manzo et al. .... D29/108  
D625,419 S \* 10/2010 Chacon ..... D24/181  
D627,107 S \* 11/2010 Manzo et al. .... D29/108  
D630,090 S \* 1/2011 Ishii et al. .... D8/383  
D633,377 S \* 3/2011 Chan ..... D8/383  
D634,480 S \* 3/2011 Manzo et al. .... D29/108  
D641,613 S \* 7/2011 Isberner ..... D8/383  
D645,154 S \* 9/2011 Belluzzi et al. .... D24/194

D649,252 S \* 11/2011 Spainhower ..... D24/181  
D651,320 S \* 12/2011 Forcier ..... D24/194  
8,104,324 B2 \* 1/2012 Hennig et al. .... 73/12.01  
D663,037 S \* 7/2012 Lopez et al. .... D24/194  
D663,485 S \* 7/2012 Turkbash et al. .... D29/108  
D671,652 S \* 11/2012 Middleton ..... D24/194

OTHER PUBLICATIONS

Vettex Pink Double Bite Mouthguard w/ Strap, Announced Dec. 3, 2009, [ Site Visited Jul. 29, 2015 ]<http://soccer.epicsports.com/prod/27726/index.html>.\*

\* cited by examiner

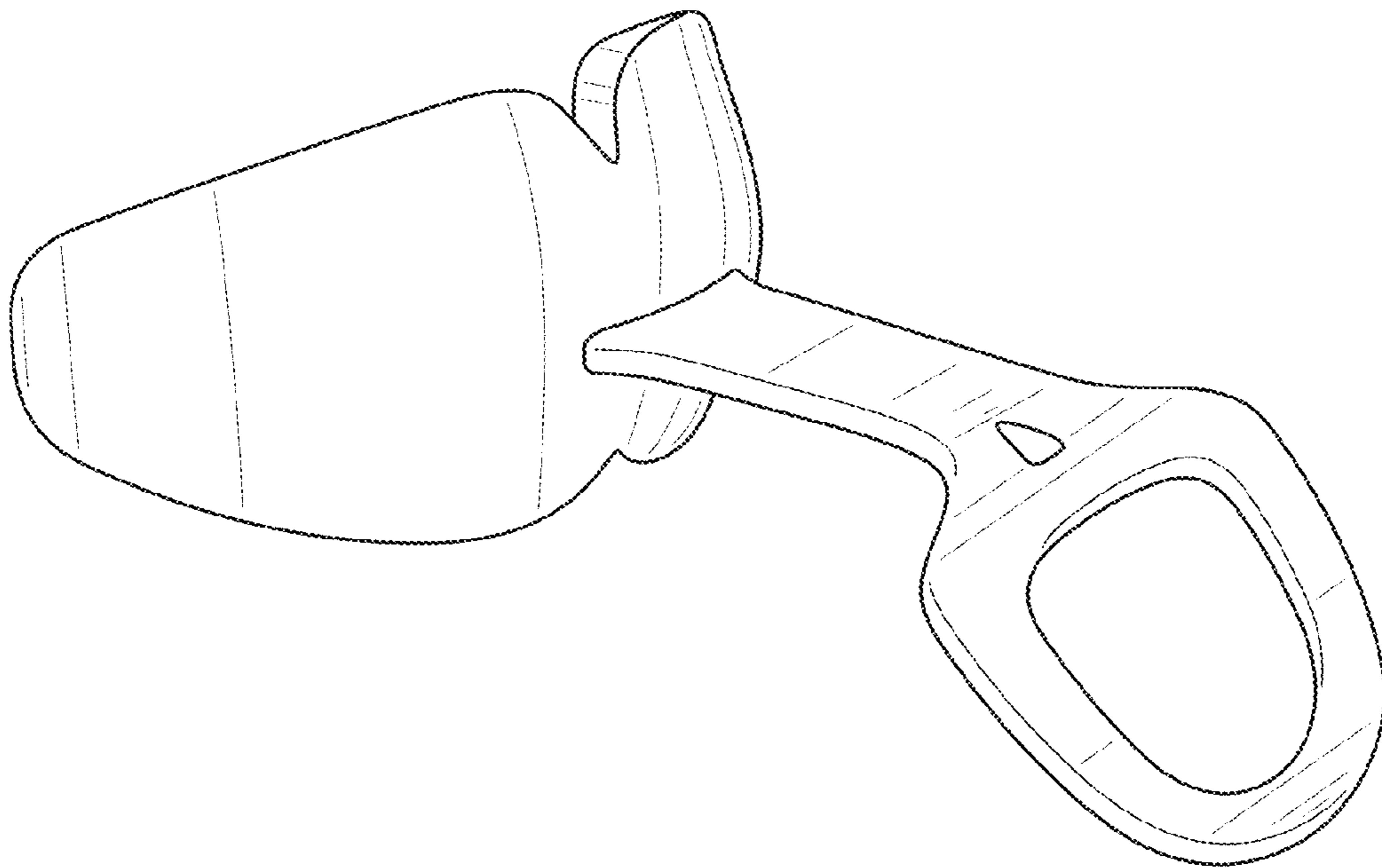

FIG. 1

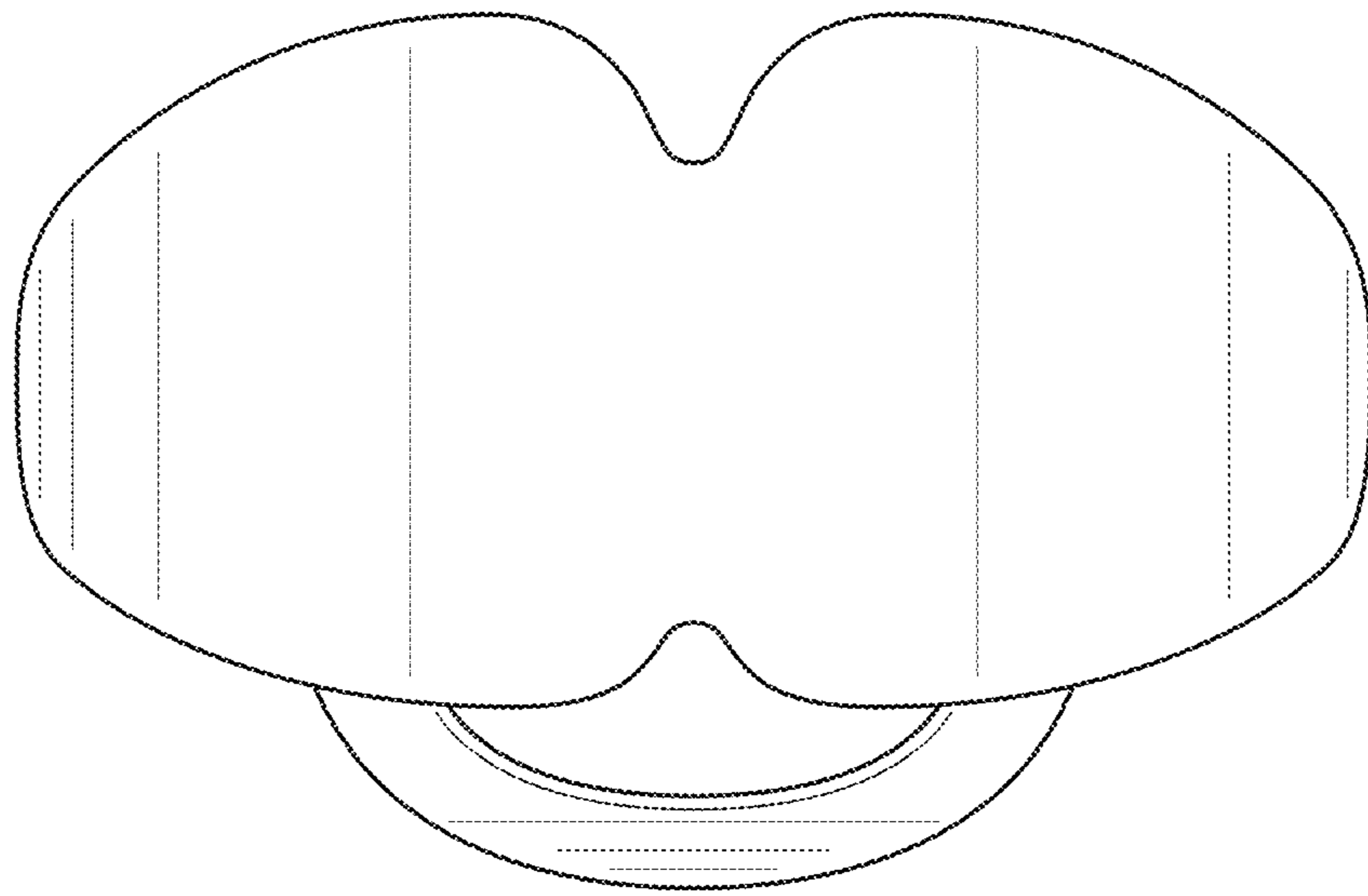

FIG. 2

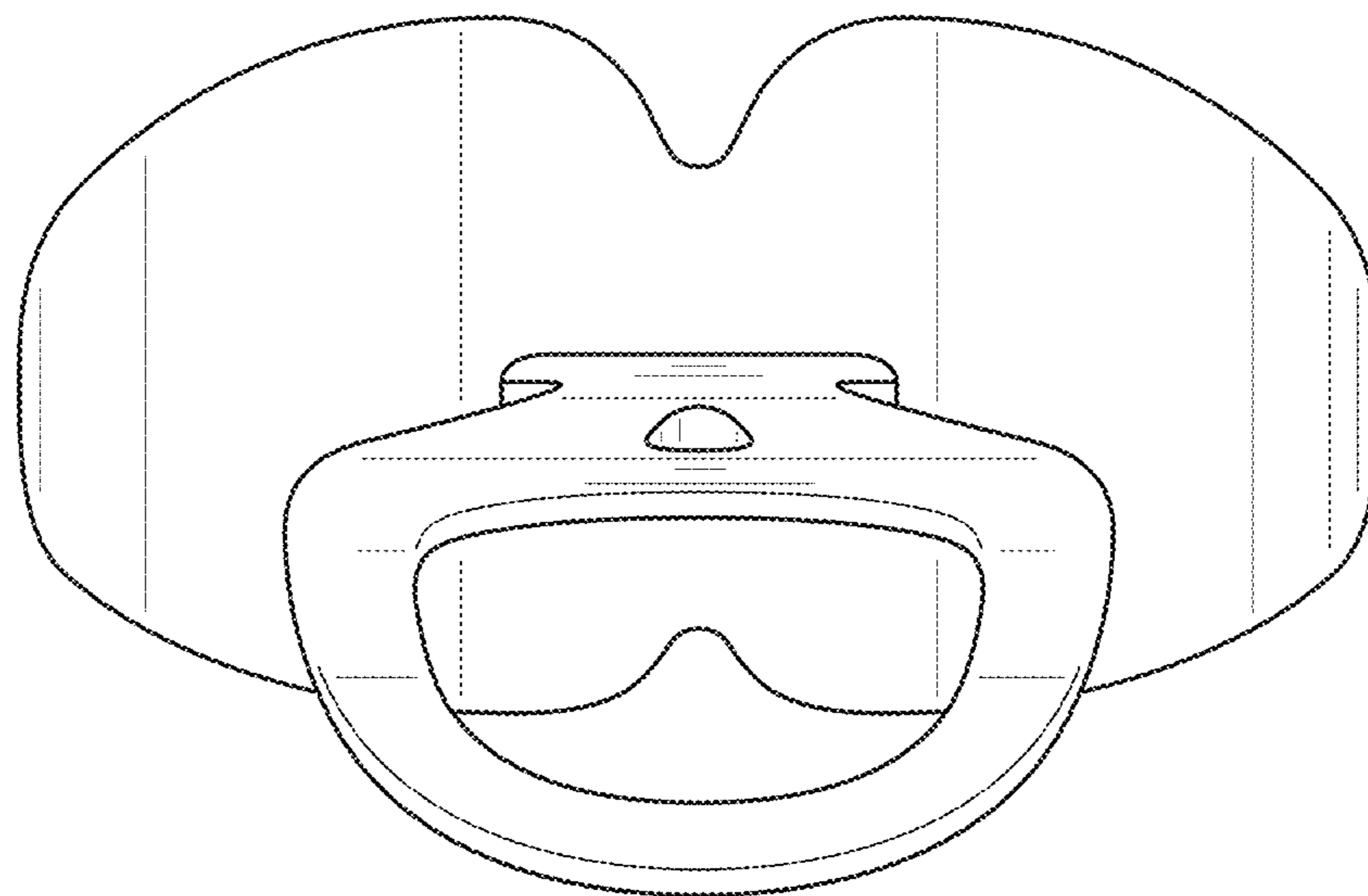

FIG. 3

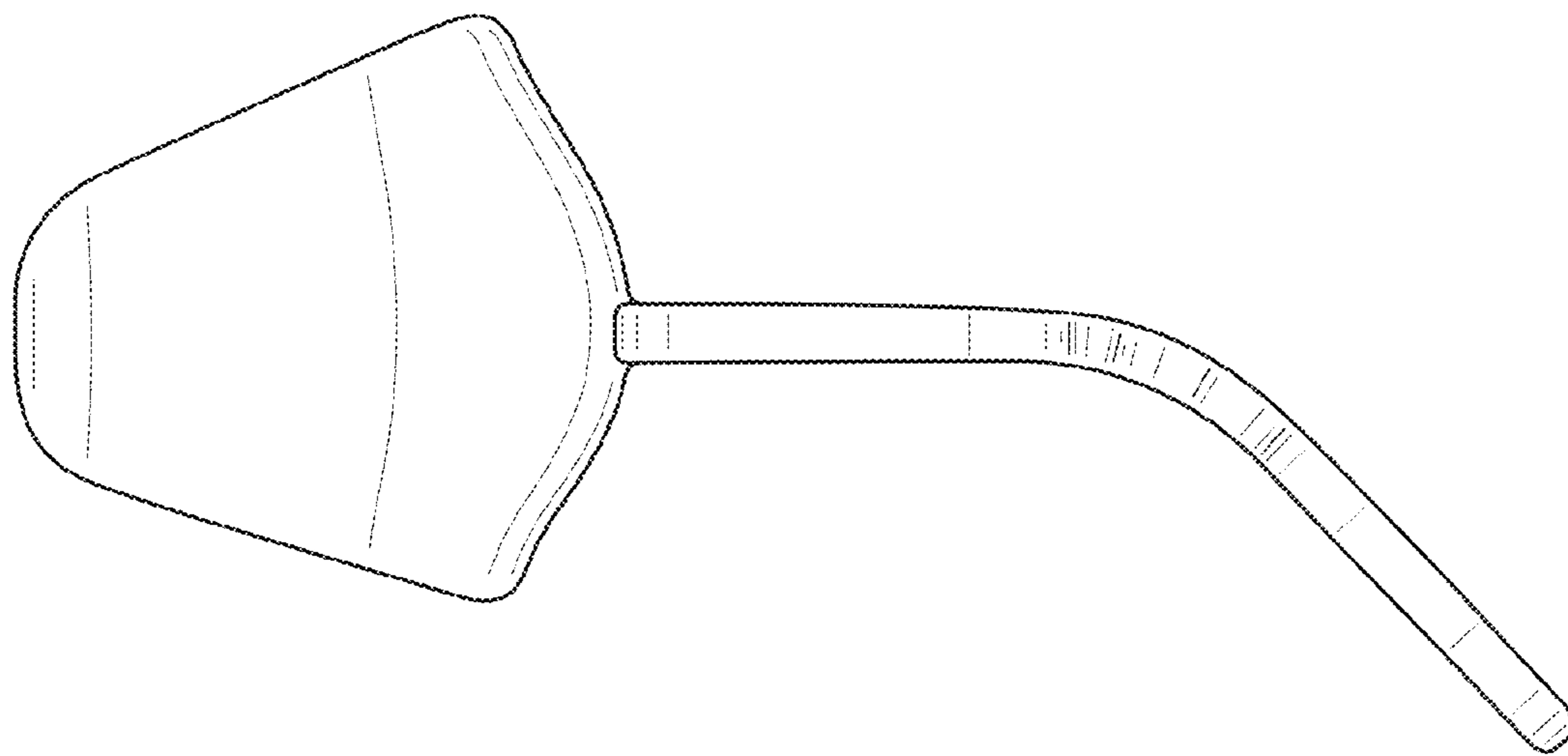

FIG. 4

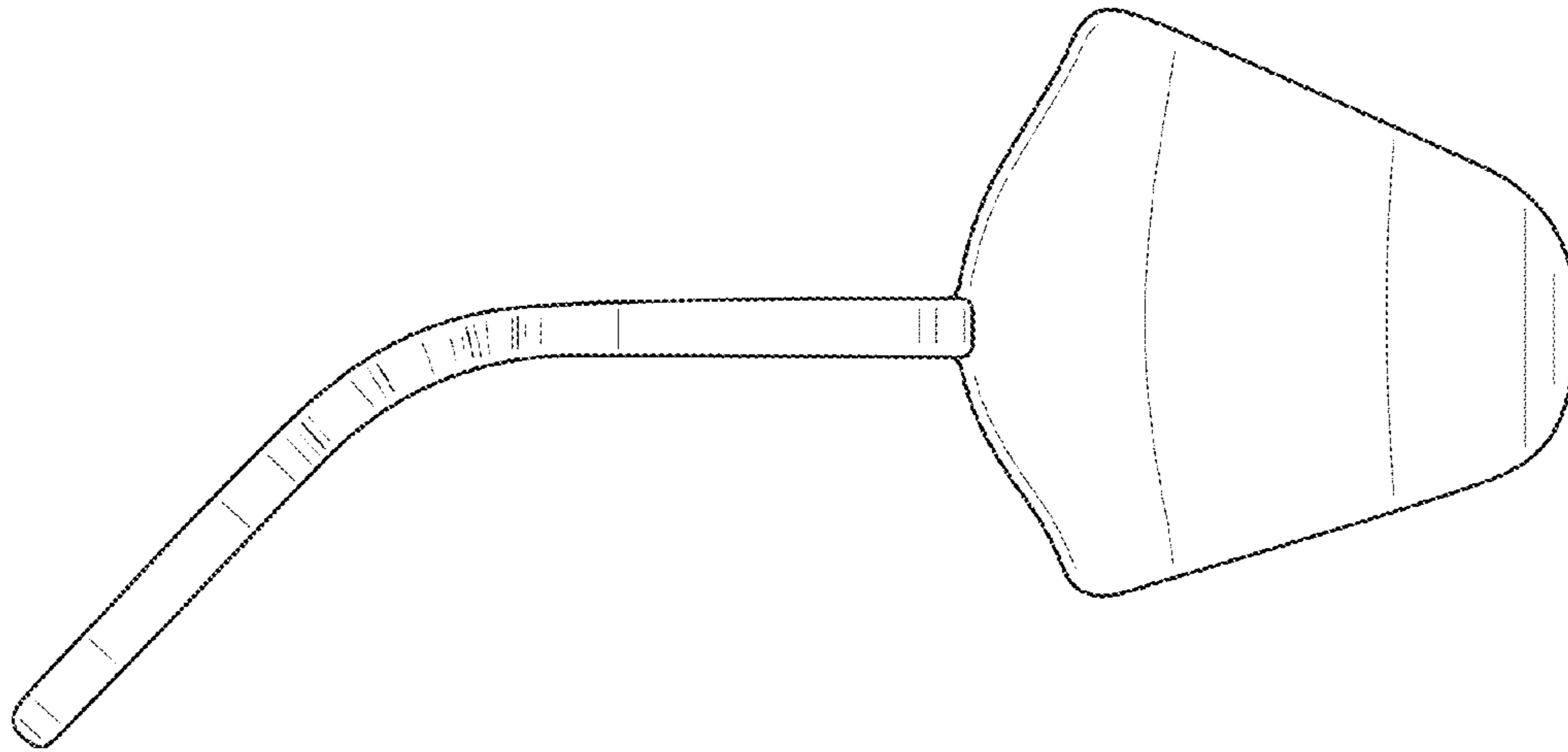

FIG. 5



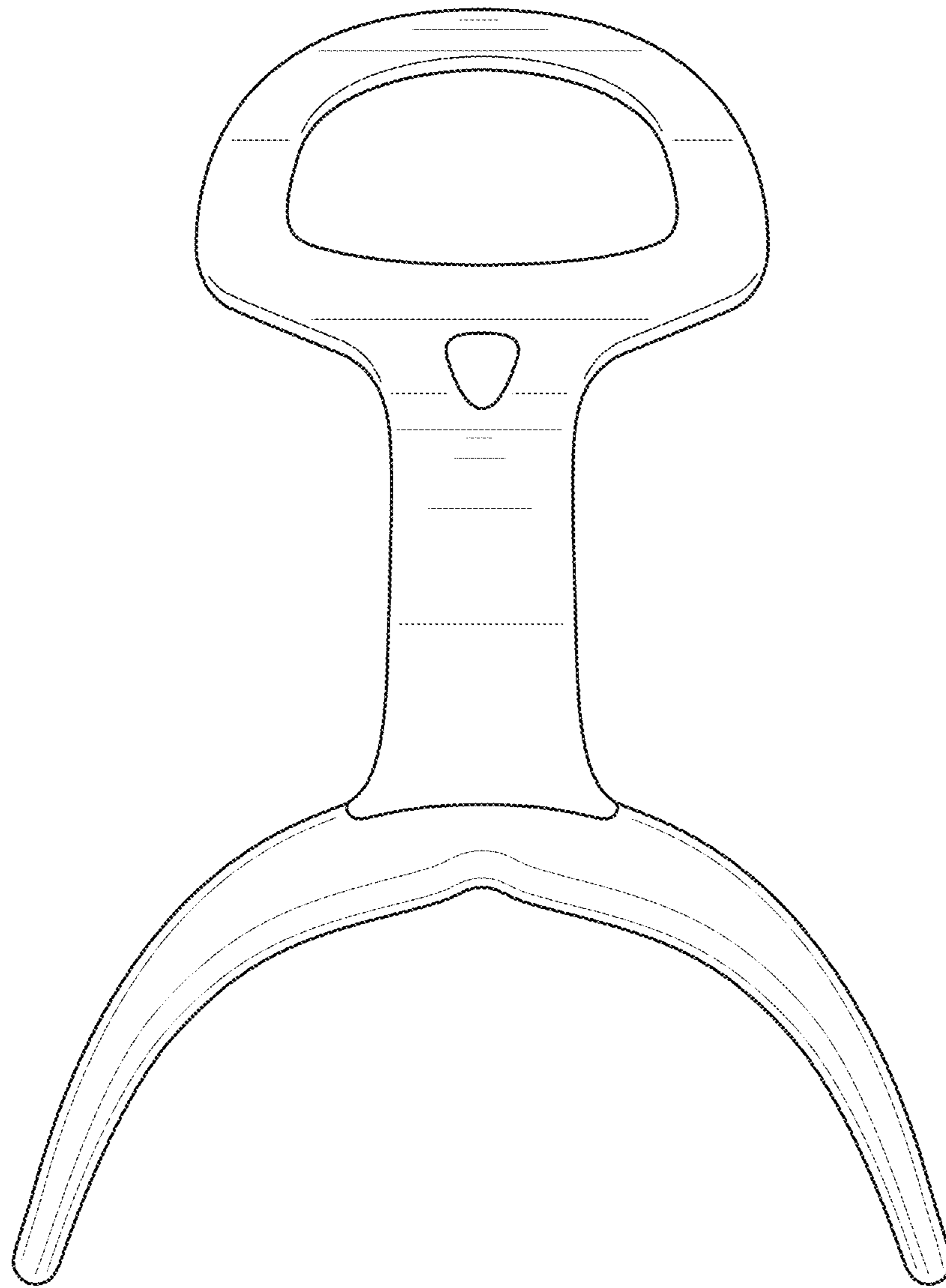

FIG. 6



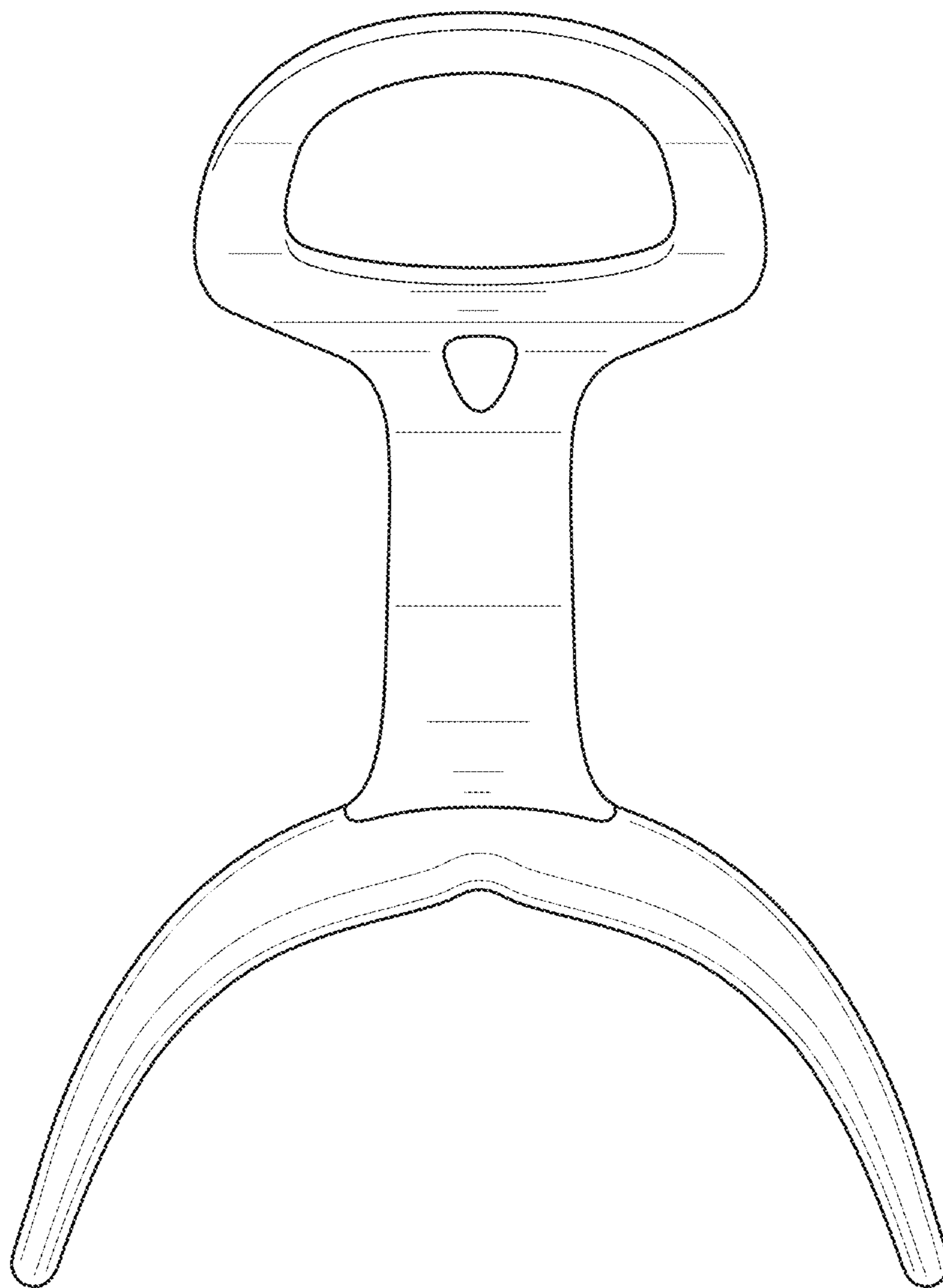

FIG. 7