



US00D754840S

(12) **United States Design Patent**
Waldman et al.

(10) **Patent No.:** **US D754,840 S**
(45) **Date of Patent:** **** Apr. 26, 2016**

(54) **ORAL DOSAGE FORM**

(75) Inventors: **Joel Waldman**, Chalfont, PA (US);
Anthony Bean, Harleysville, PA (US);
Fernanda Franzoi, São Paulo (BR)

(73) Assignees: **Johnson & Johnson Consumer Inc.**,
Skillman, NJ (US); **Johnson & Johnson**
Industrial LTDA, Sao Paulo (BR)

(**) Term: **14 Years**

(21) Appl. No.: **29/412,543**

(22) Filed: **Feb. 3, 2012**

(51) **LOC (10) Cl.** **24-01**

(52) **U.S. Cl.**
USPC **D24/101**

(58) **Field of Classification Search**

USPC D24/100-104; D1/100, 127, 130;
D23/207, 208; 604/287, 288, 403;
206/1.5, 528, 530-539; 424/10.2, 10.3,
424/408, 438, 439, 451, 472, 473, 475,
424/453-456, 464-469

See application file for complete search history.

(56) **References Cited**

U.S. PATENT DOCUMENTS

3,281,620 A * 10/1966 Miller 313/113
4,503,031 A * 3/1985 Glassman 424/467

(Continued)

FOREIGN PATENT DOCUMENTS

WO D 000679089 8/2007

Primary Examiner — Susan Hattan

Assistant Examiner — Charles Hanson

(74) *Attorney, Agent, or Firm* — Victor Tsu

(57) **CLAIM**

The ornamental design for an oral dosage form, as shown and described.

DESCRIPTION

FIG. 1 is a front right bottom perspective view of an oral dosage form, showing our claimed design;

FIG. 2 is a front plan view of FIG. 1;

FIG. 3 is an end view of FIG. 1, the other end view being a mirror image thereof;

FIG. 4 is a top end view of FIG. 1;

FIG. 5 is a bottom end view of FIG. 1;

FIG. 6 is a front right bottom perspective view of an oral dosage form, showing a second embodiment;

FIG. 7 is a front plan view of FIG. 6;

FIG. 8 is an end view of FIG. 6, the other end view being a mirror image thereof;

FIG. 9 is a top end view of FIG. 6, the bottom end view being a mirror image thereof;

FIG. 10 is a front right bottom perspective view of an oral dosage form, showing a third embodiment;

FIG. 11 is a front plan view of FIG. 10;

FIG. 12 is an end view of FIG. 10, the other end view being a mirror image thereof;

FIG. 13 is a top end view of FIG. 10;

FIG. 14 is a bottom end view of FIG. 10;

FIG. 15 is a front right bottom perspective view of an oral dosage form, showing a fourth embodiment;

FIG. 16 is a front plan view of FIG. 15;

FIG. 17 is an end view of FIG. 15, the other end view being a mirror image thereof;

FIG. 18 is a top end view of FIG. 15, the bottom end view being a mirror image thereof;

FIG. 19 is a front right bottom perspective view of an oral dosage form, showing a fifth embodiment;

FIG. 20 is a front plan view of FIG. 19;

FIG. 21 is an end view of FIG. 19, the other end view being a mirror image thereof;

FIG. 22 is a top end view of FIG. 19;

FIG. 23 is a bottom end view of FIG. 19;

FIG. 24 is a front right bottom perspective view of an oral dosage form, showing a sixth embodiment;

FIG. 25 is a front plan view of FIG. 24;

FIG. 26 is an end view of FIG. 24, the other end view being a mirror image thereof;

FIG. 27 is a top end view of FIG. 24, the bottom end view being a mirror image thereof;

FIG. 28 is a front right bottom perspective view of an oral dosage form, showing a seventh embodiment;

FIG. 29 is a front plan view of FIG. 28;

FIG. 30 is an end view of the oral dosage form of FIG. 28, the other end view being a mirror image thereof;

FIG. 31 is a top end view of FIG. 28; and,

FIG. 32 is a bottom end view of FIG. 28.

The evenly spaced broken line showing is included for the purpose of illustrating environment and the dash-dot-dash lines represent the bounds of the claimed design, both of which form no part of the claimed design.

1 Claim, 28 Drawing Sheets

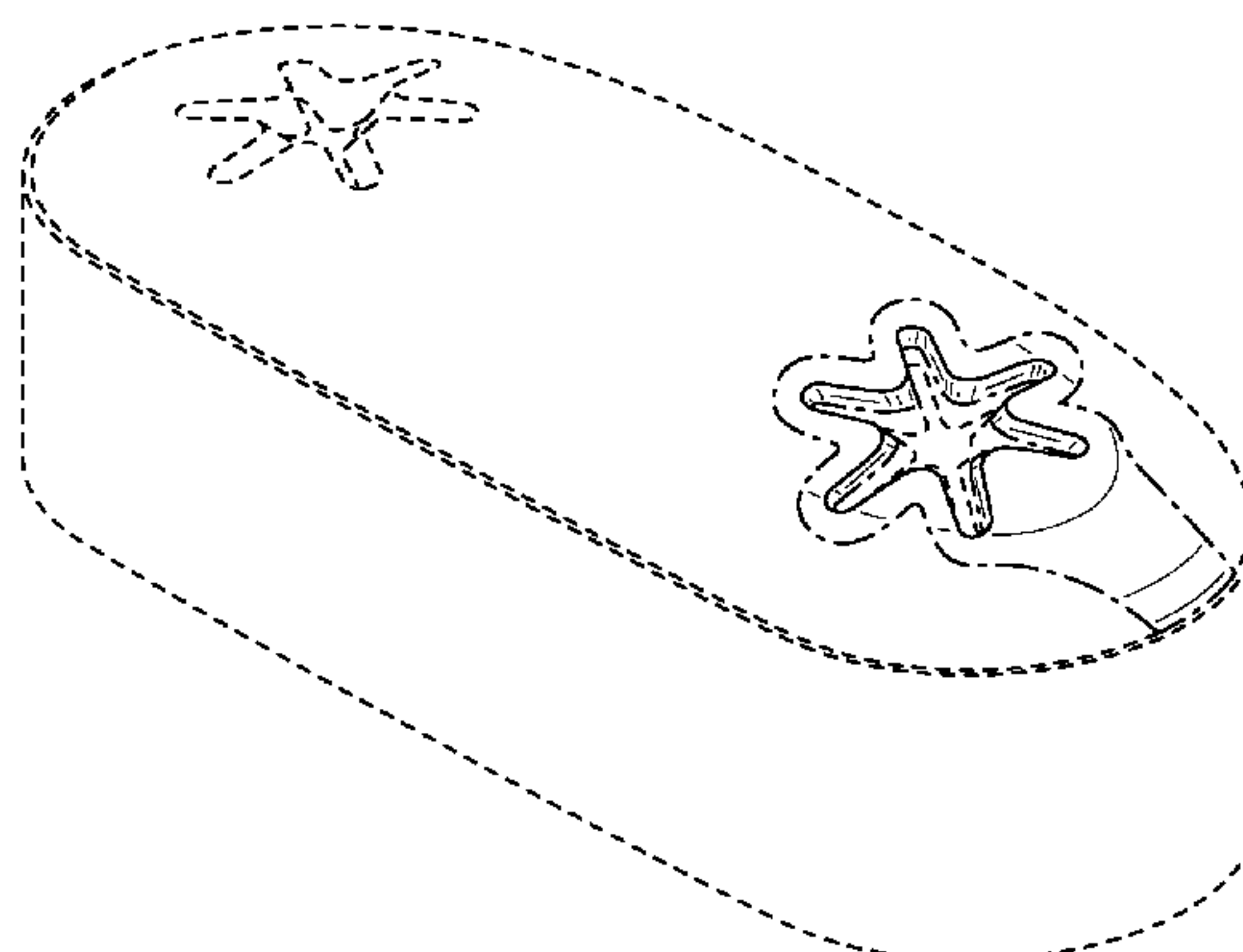
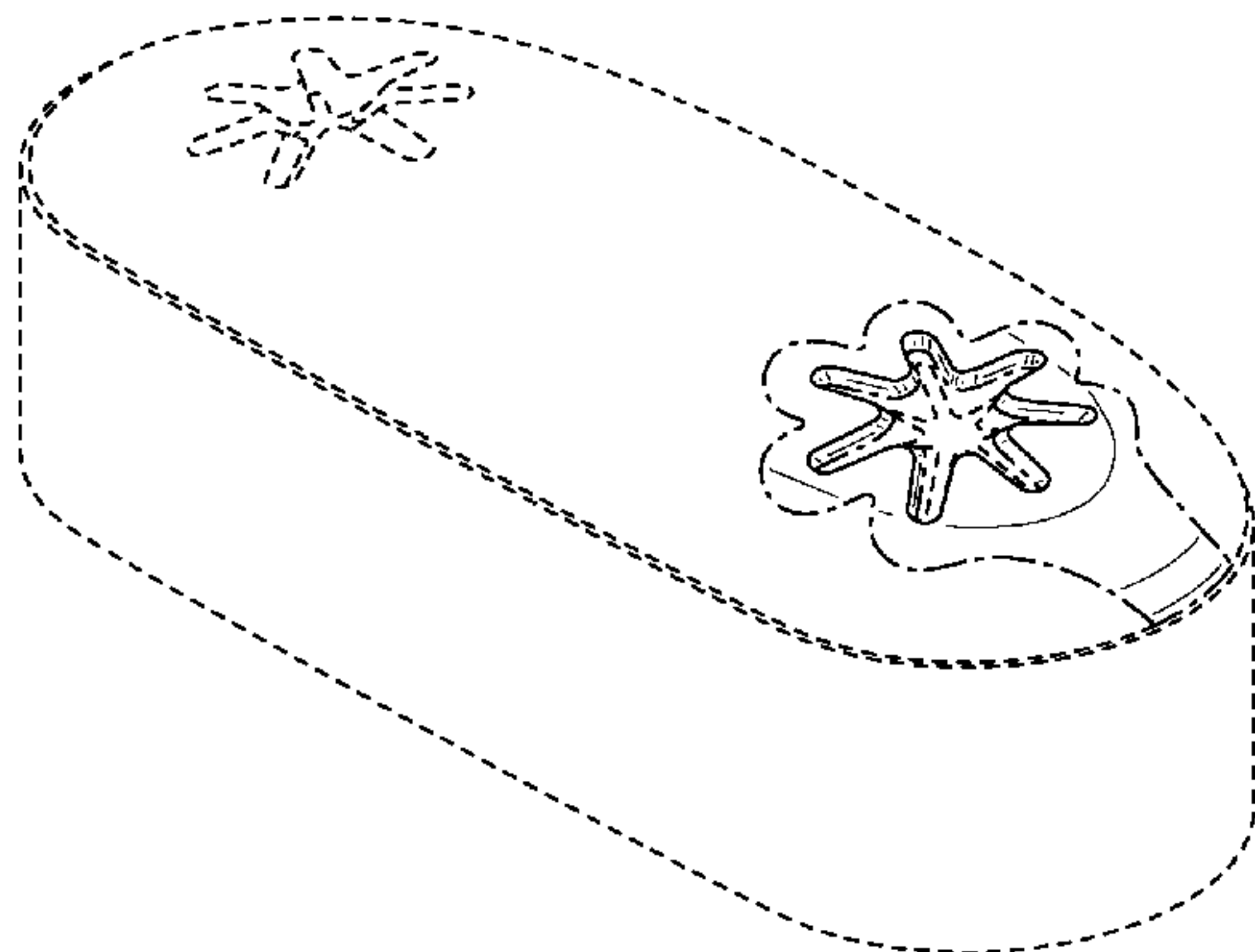

(56)

References Cited

U.S. PATENT DOCUMENTS

D285,364 S * 8/1986 Tovey D24/101
 D304,626 S * 11/1989 Contractor et al. D24/102
 D334,420 S * 3/1993 Gladfelter et al. D23/207
 D334,421 S * 3/1993 Gladfelter et al. D23/207
 D377,977 S * 2/1997 Price et al. D24/101
 D431,076 S 9/2000 Chen et al.
 D434,846 S * 12/2000 Chen et al. D24/102
 D459,798 S * 7/2002 Desesquelle et al. D24/101
 D506,544 S * 6/2005 Rinker et al. D24/101
 D515,202 S * 2/2006 Chen et al. D24/102

D534,646 S * 1/2007 Chang et al. D24/101
 D535,016 S * 1/2007 Stawski et al. D24/101
 7,169,450 B2 1/2007 Bunick
 D549,724 S * 8/2007 Nijima D14/491
 D549,725 S * 8/2007 Nijima D14/491
 D564,086 S * 3/2008 Nielsen et al. D24/101
 D636,865 S * 4/2011 Vepuri D24/103
 D667,430 S * 9/2012 Ouilhet et al. D14/489
 D671,636 S * 11/2012 Nishino D24/101
 D685,460 S * 7/2013 Illing et al. D24/101
 2004/0146559 A1 7/2004 Sowden et al.
 2007/0098931 A1 5/2007 Bunick
 2008/0317678 A1 12/2008 Szymczak et al.

* cited by examiner

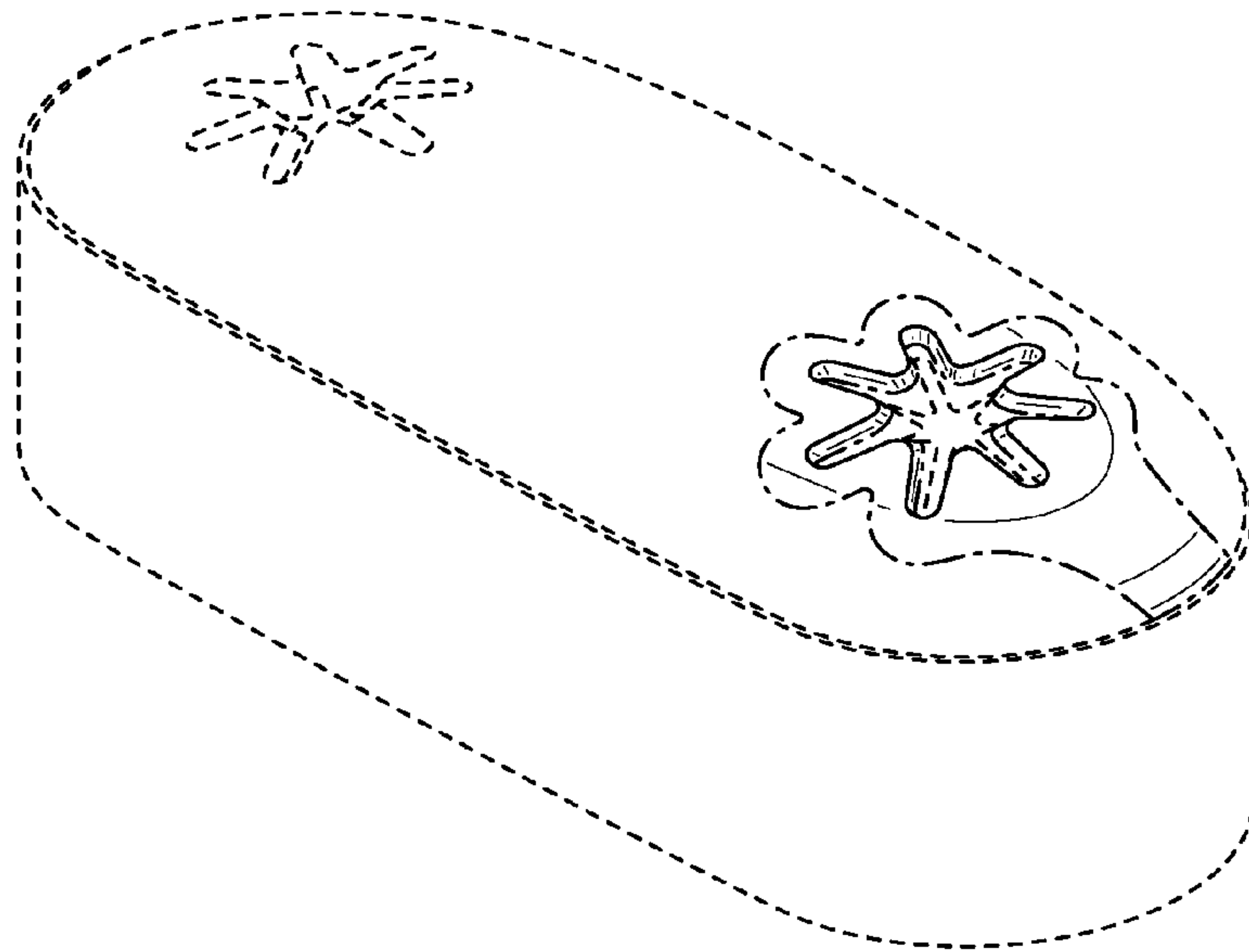

FIG. 1

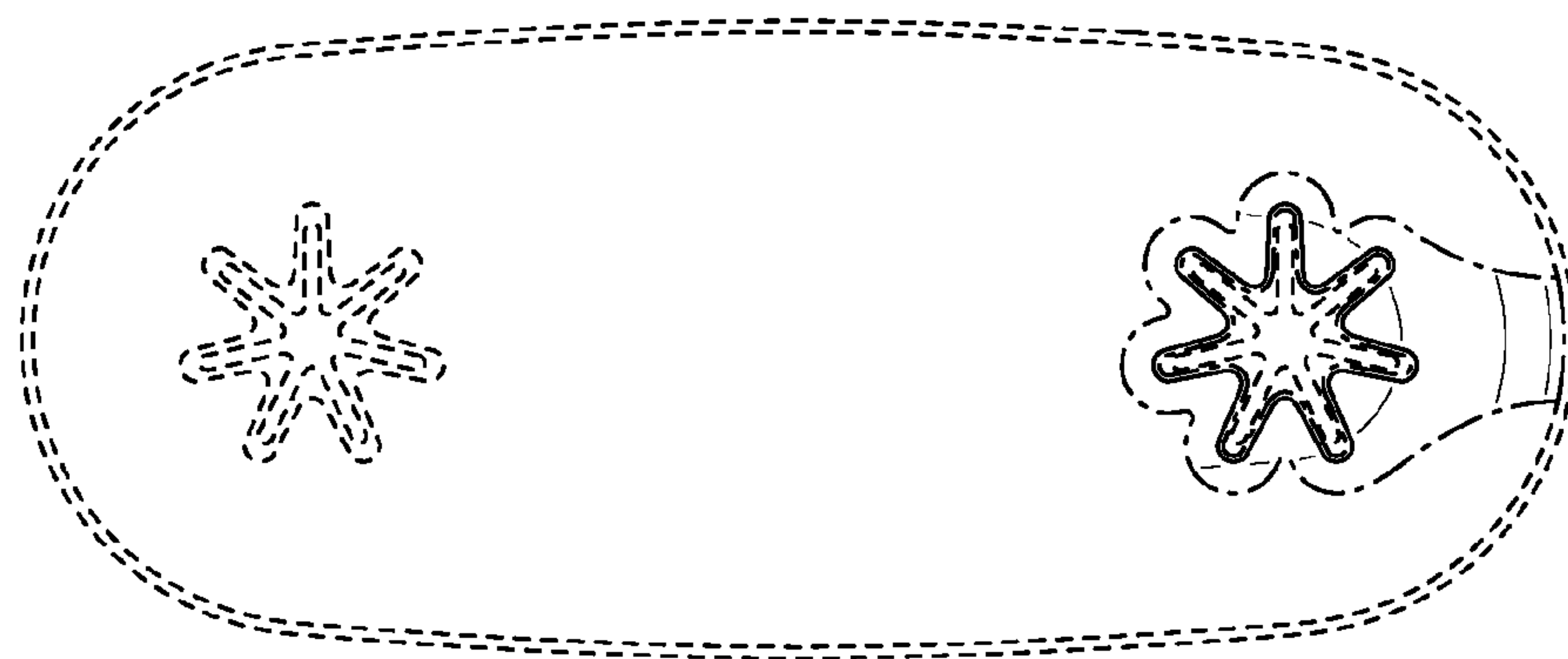

FIG. 2

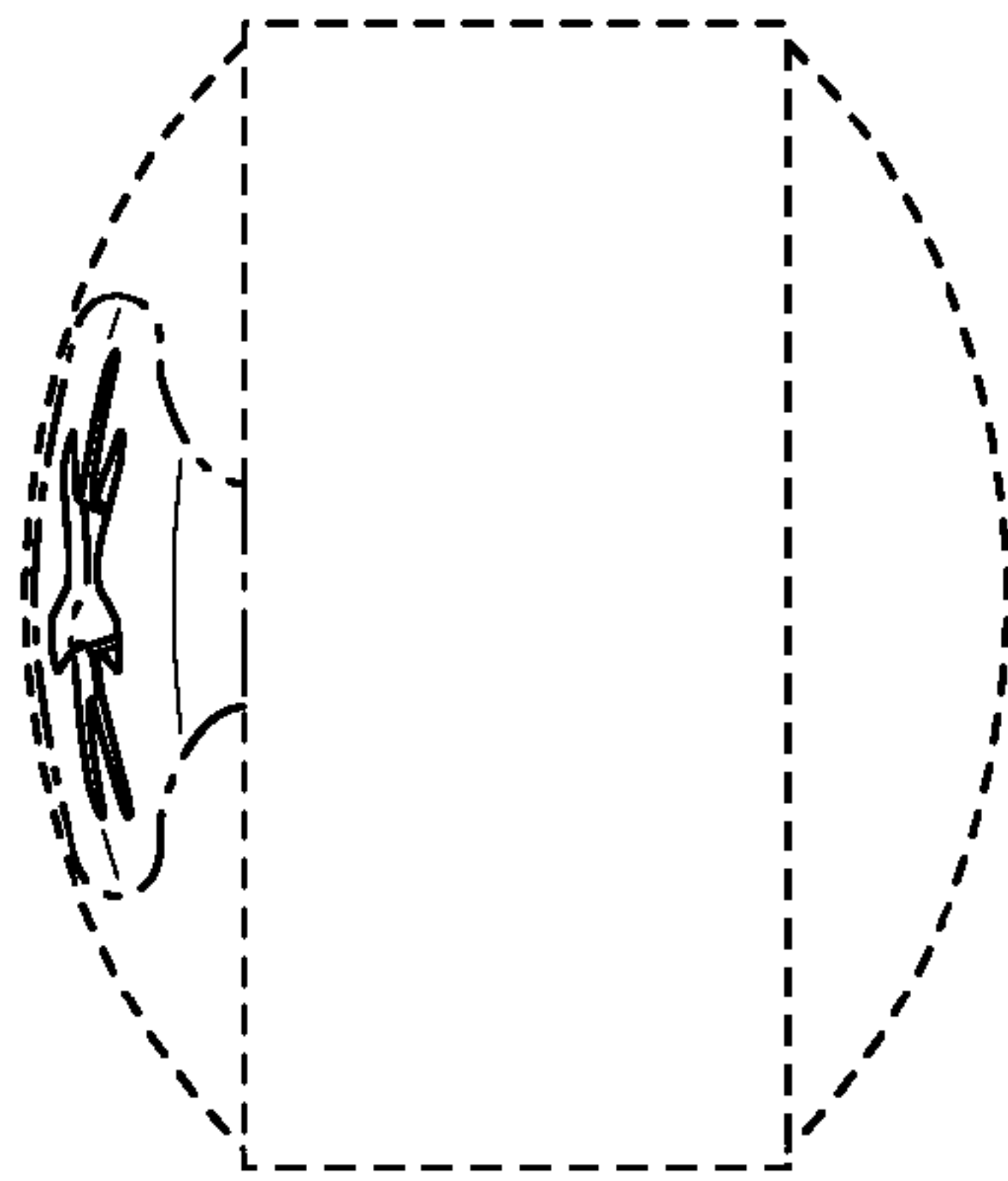

FIG. 3

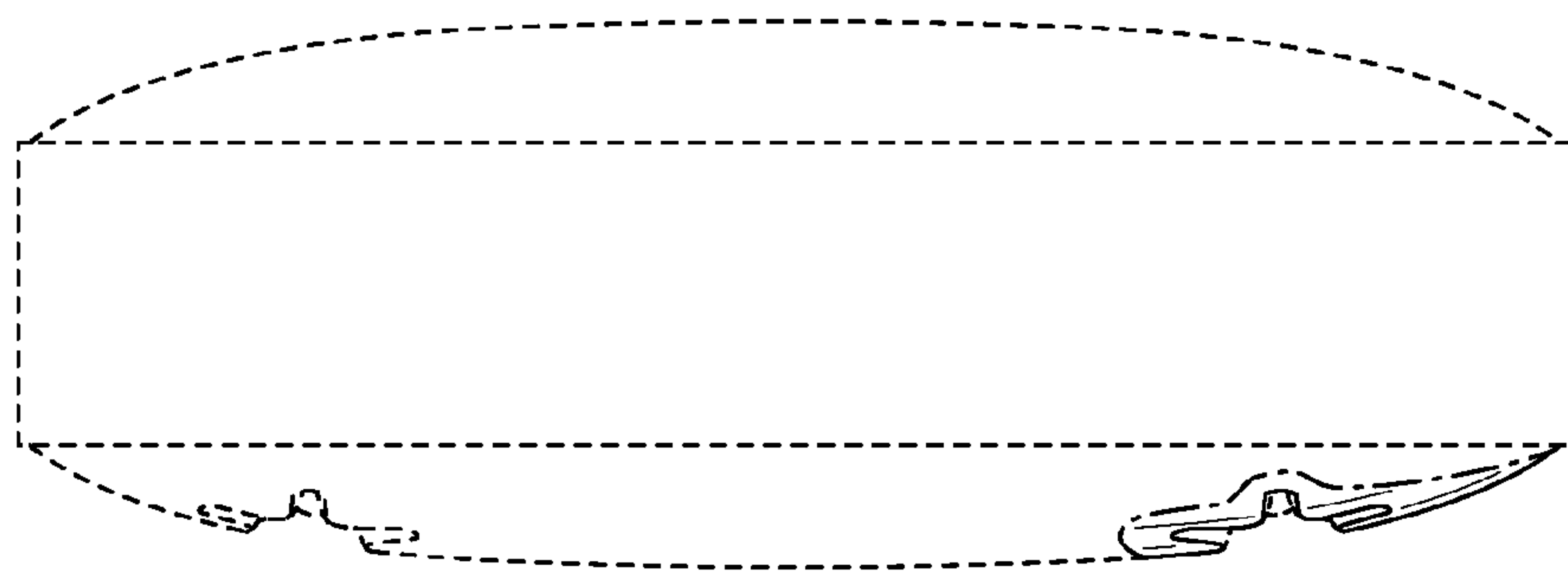

FIG. 4

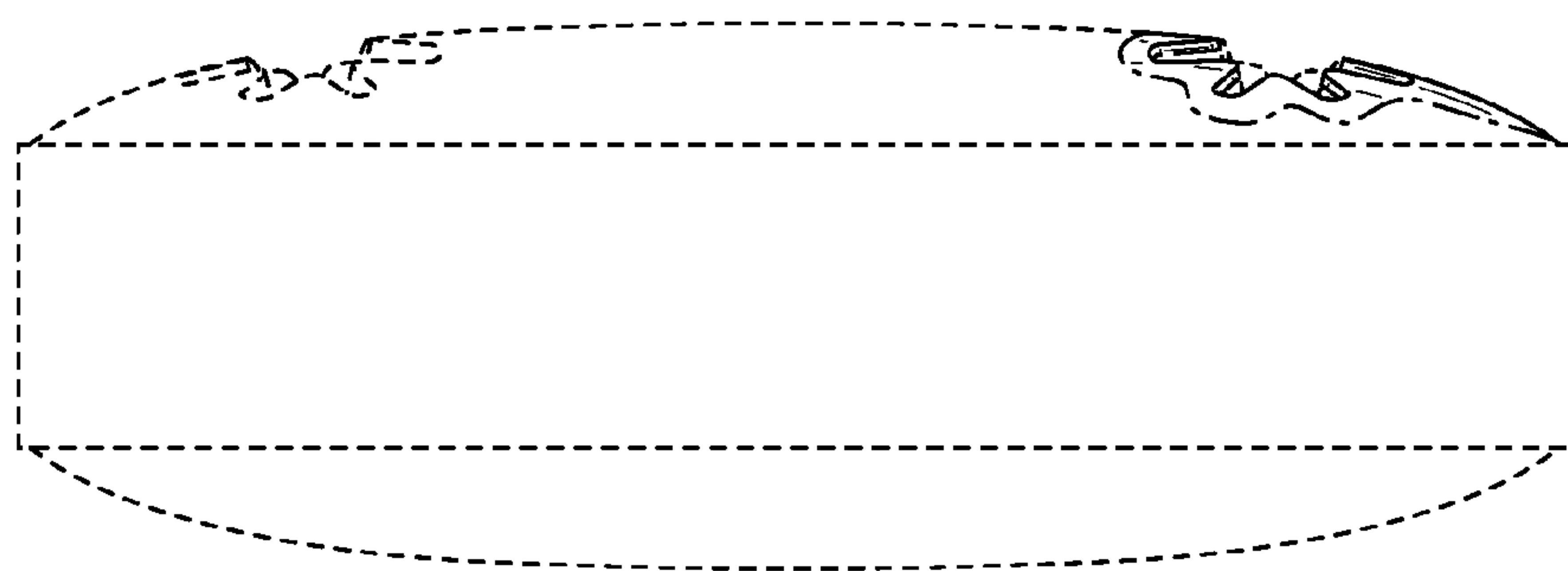

FIG. 5

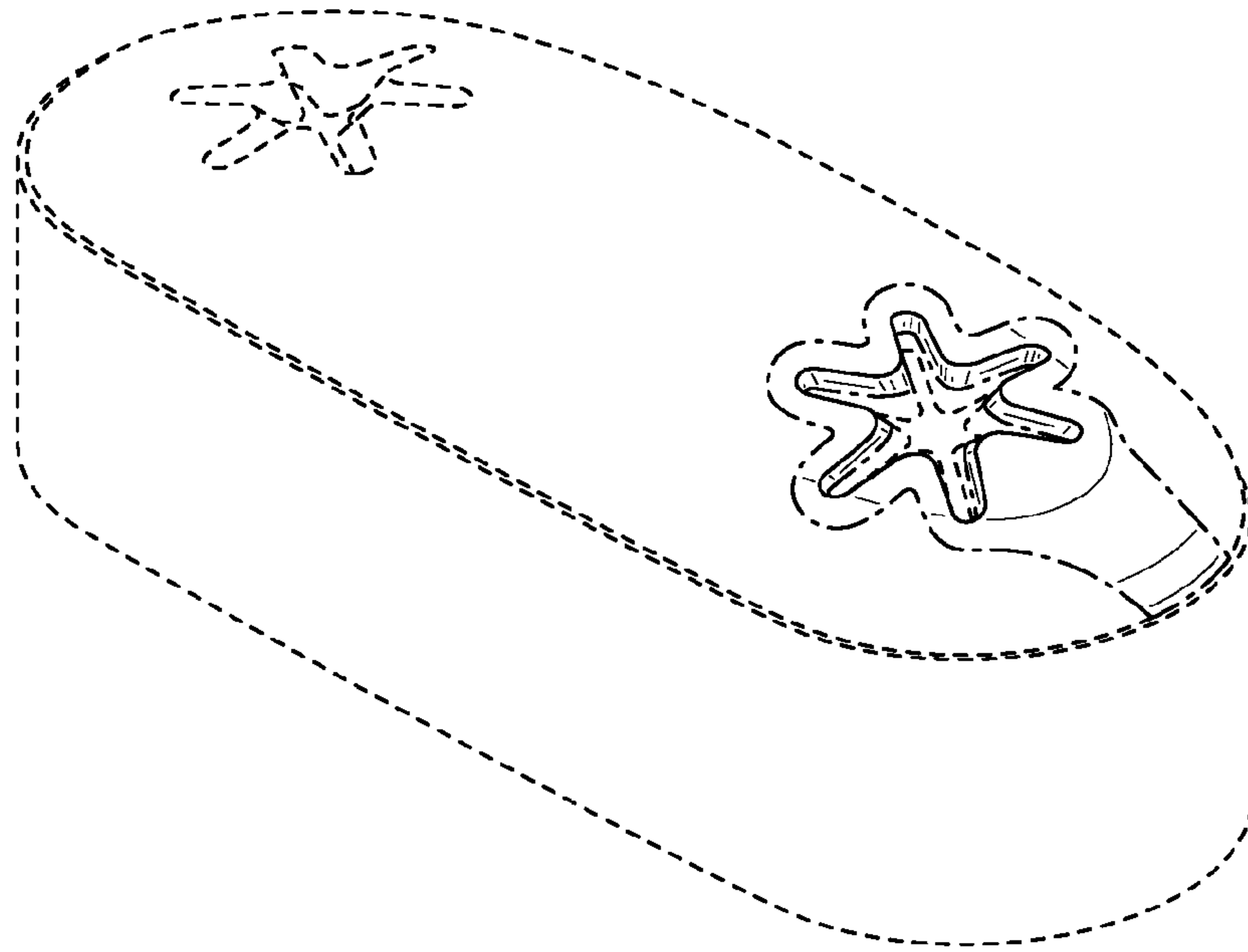

FIG. 6

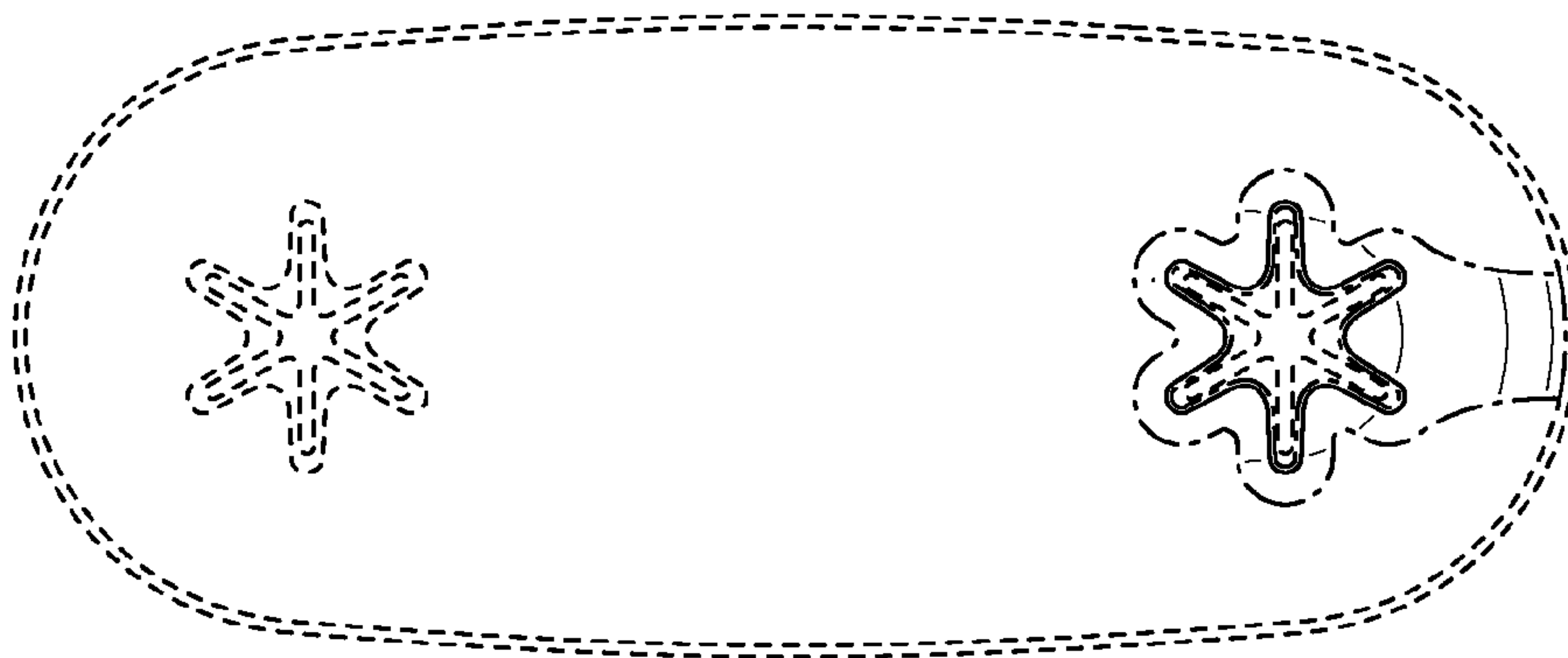

FIG. 7

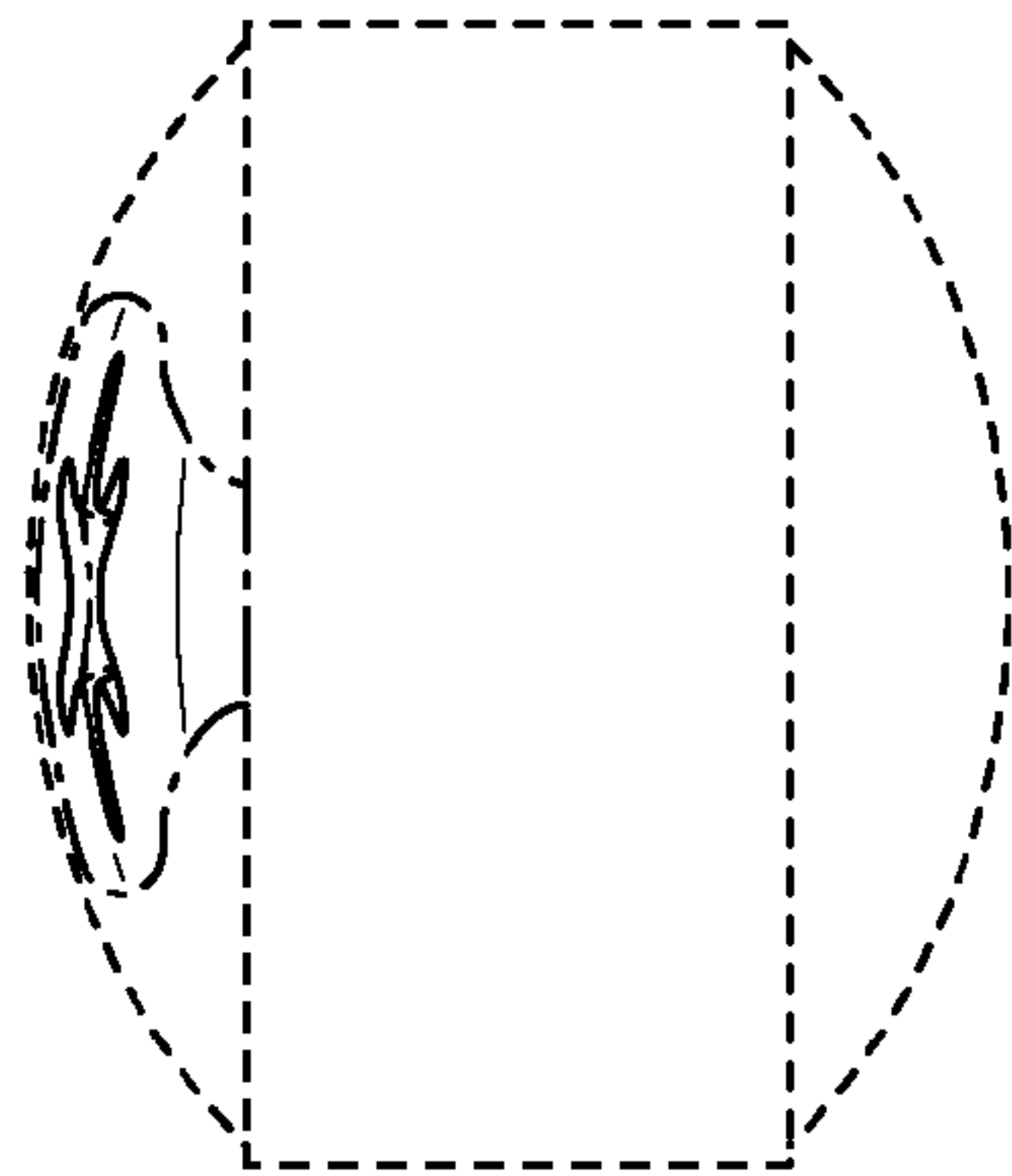

FIG. 8

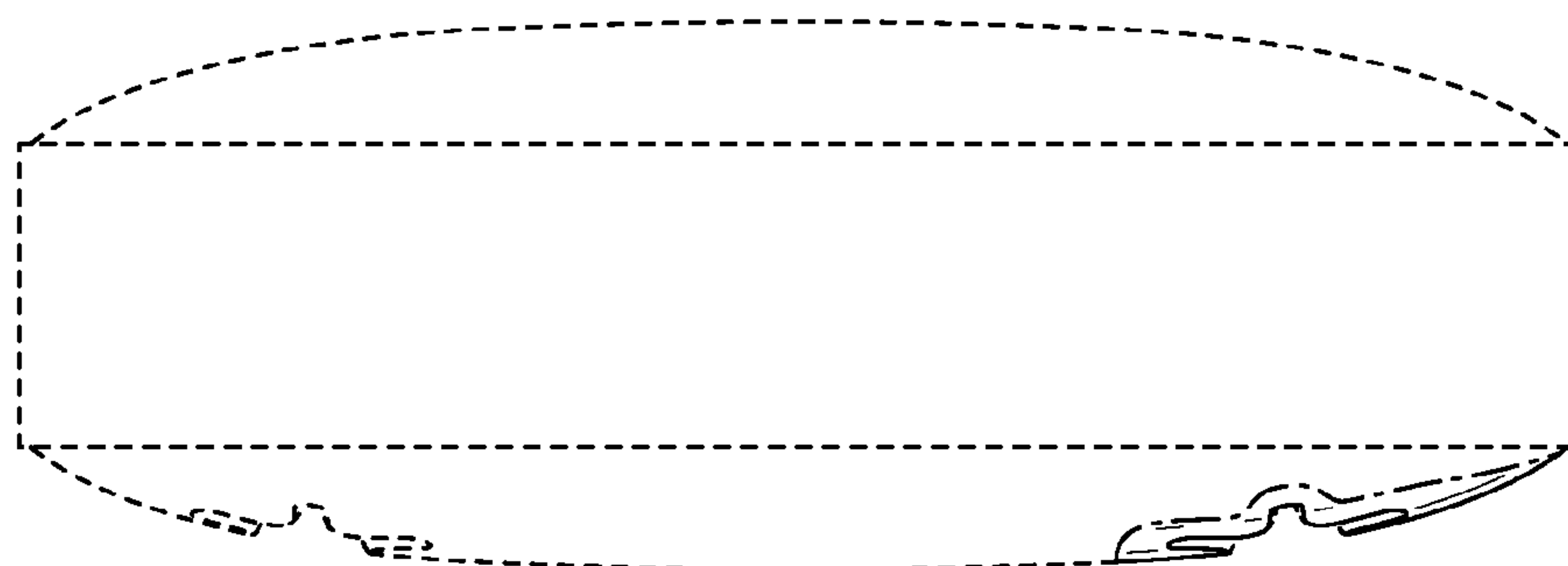

FIG. 9

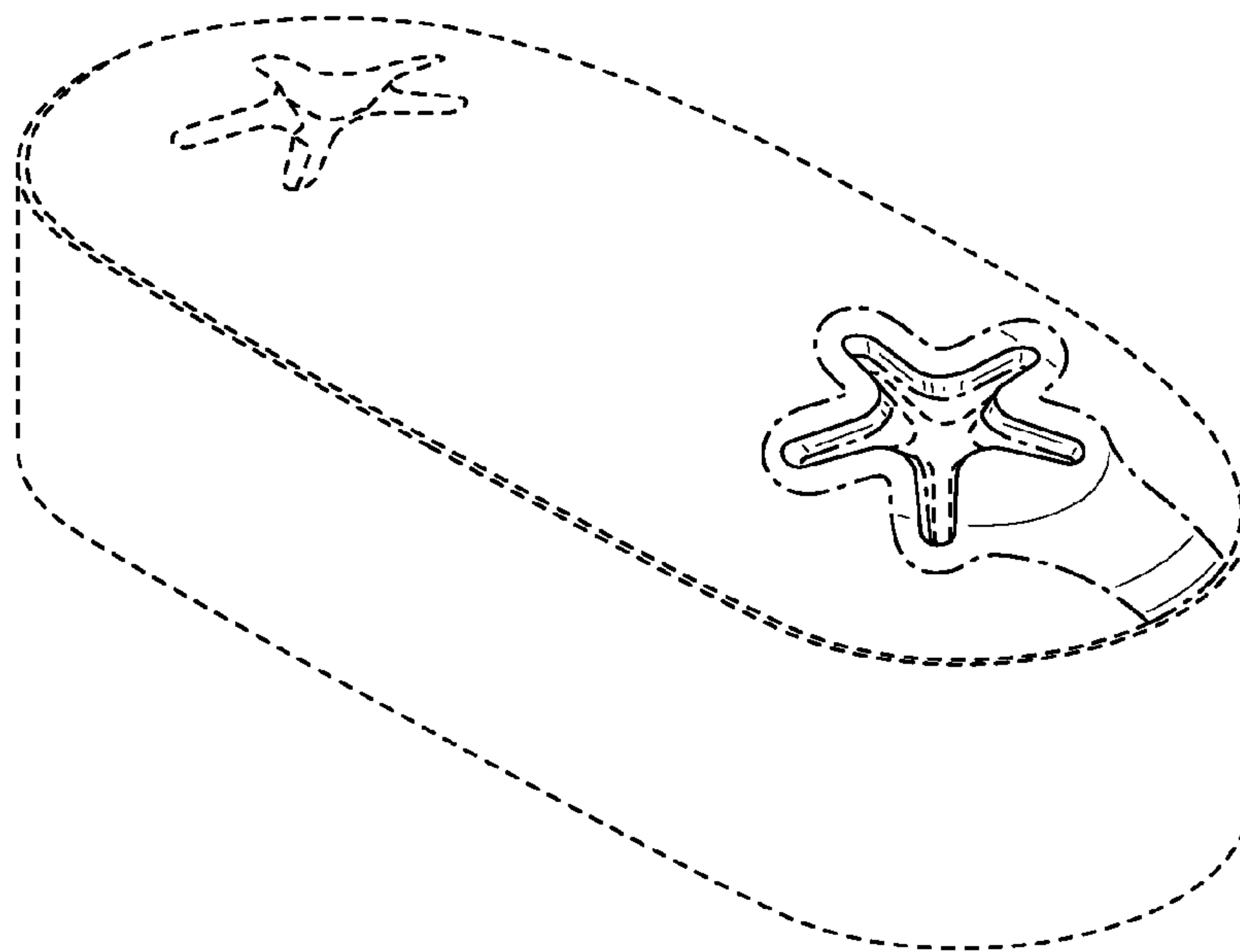

FIG. 10

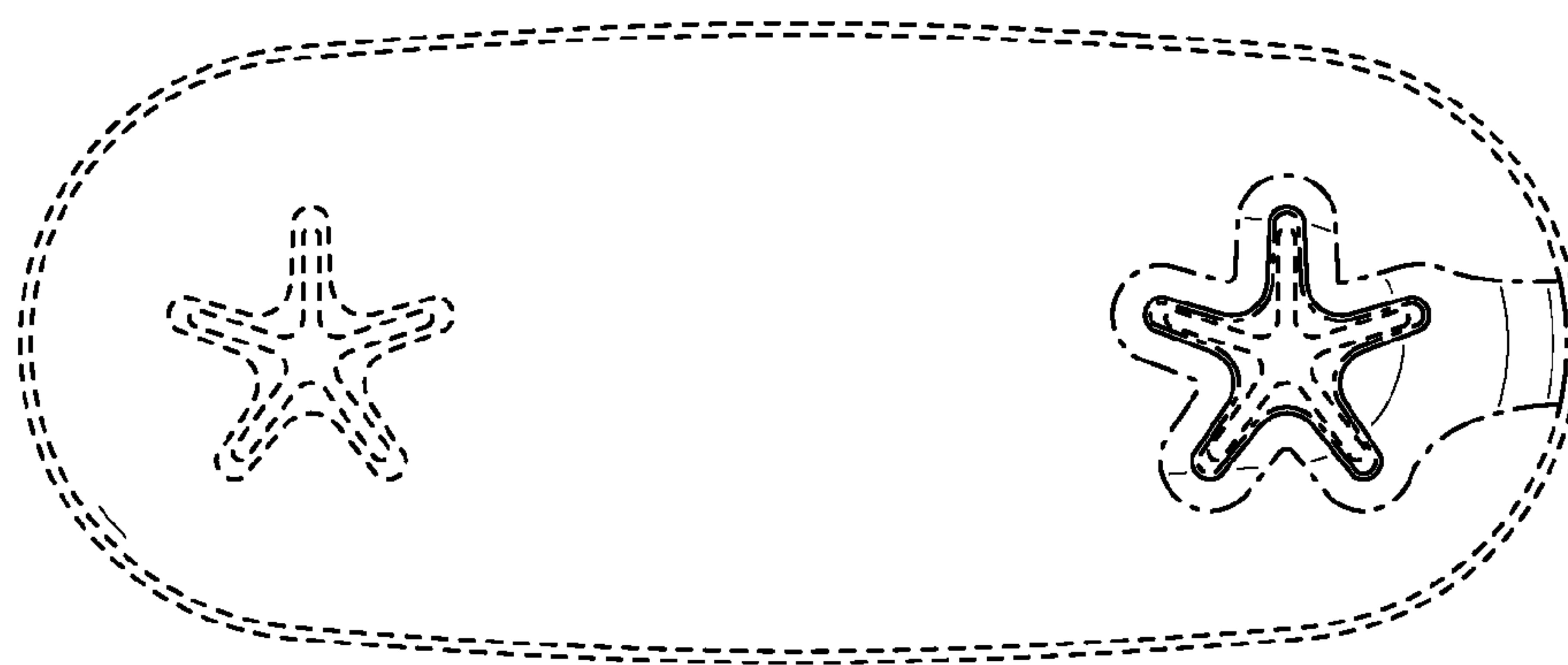

FIG. 11

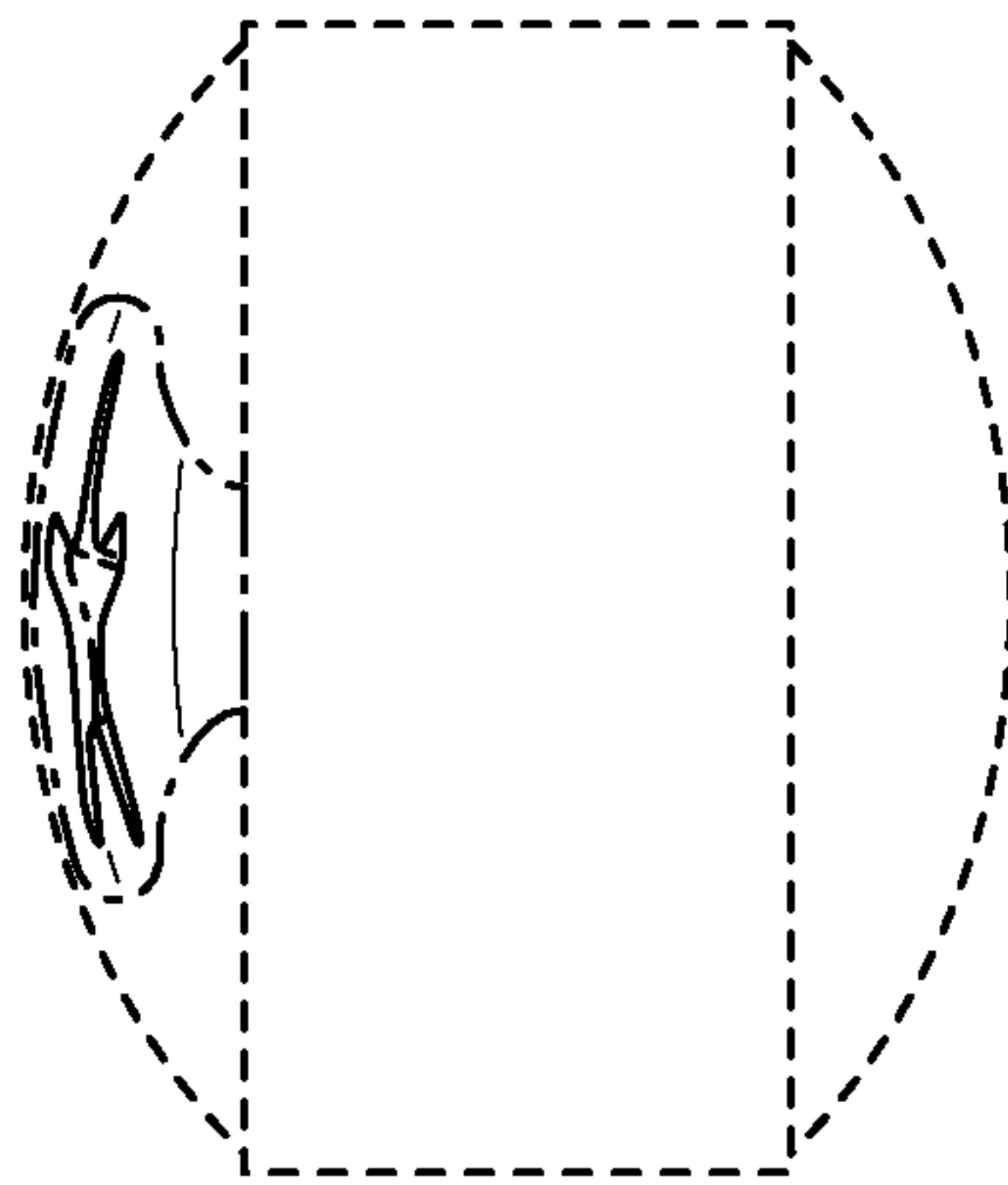

FIG. 12

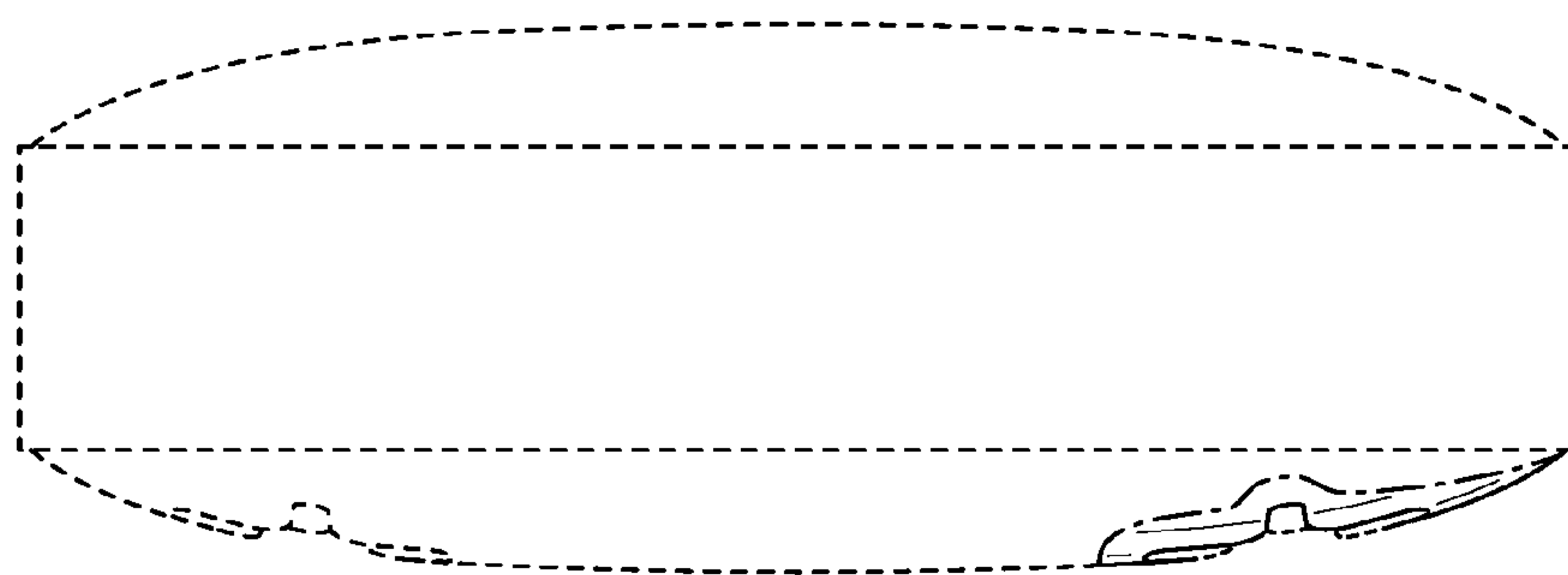

FIG. 13

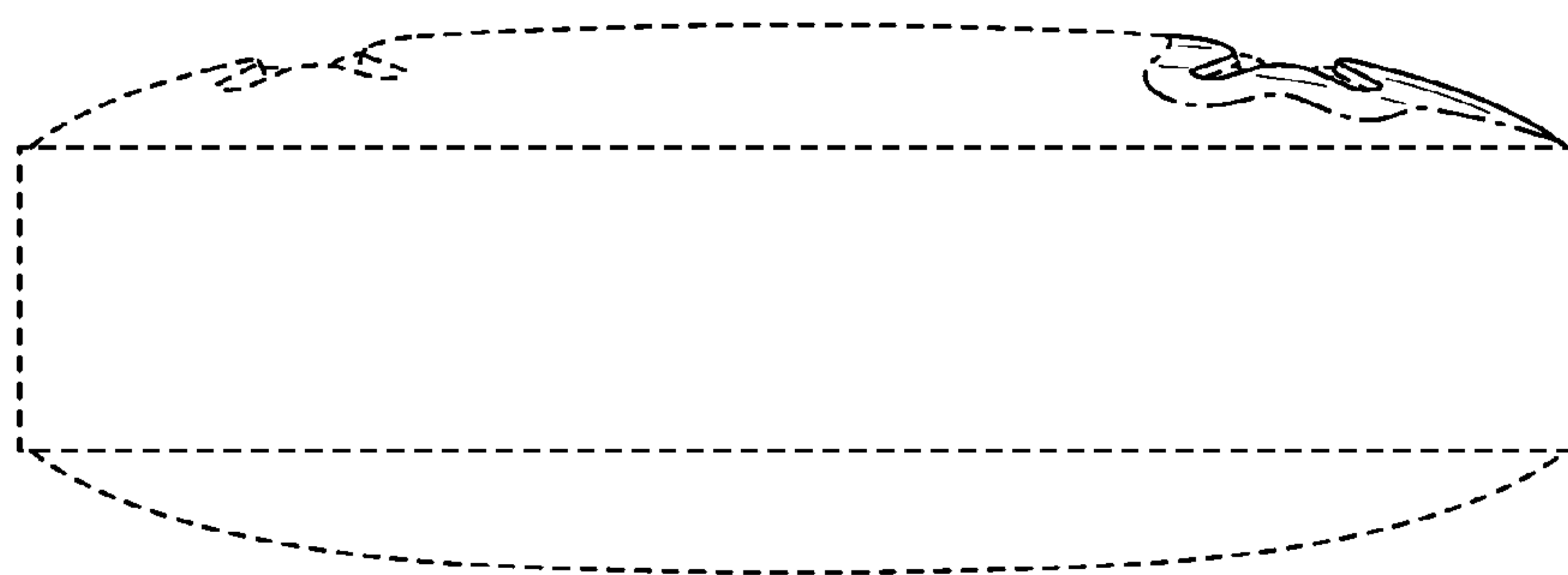

FIG. 14

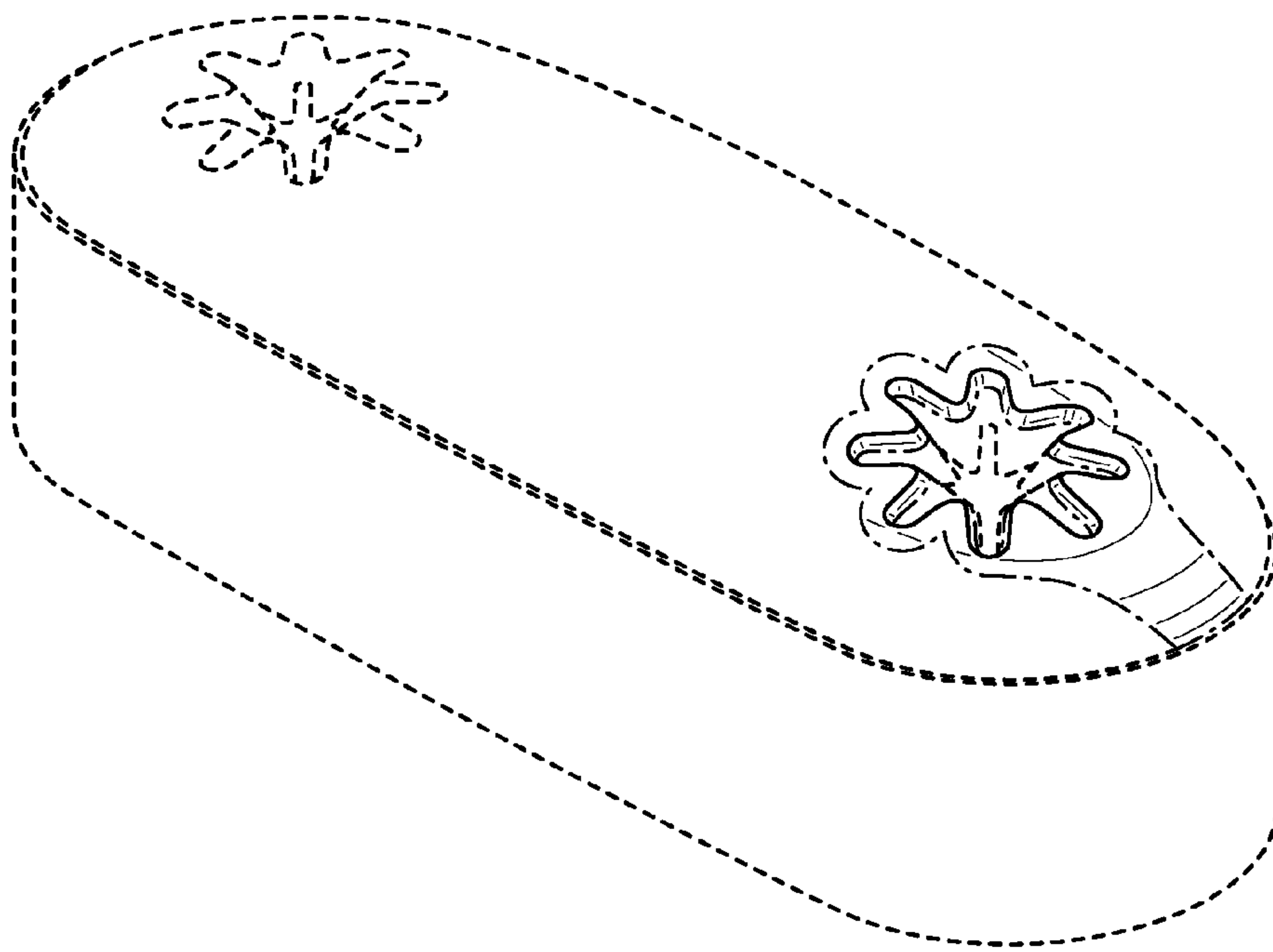

FIG. 15

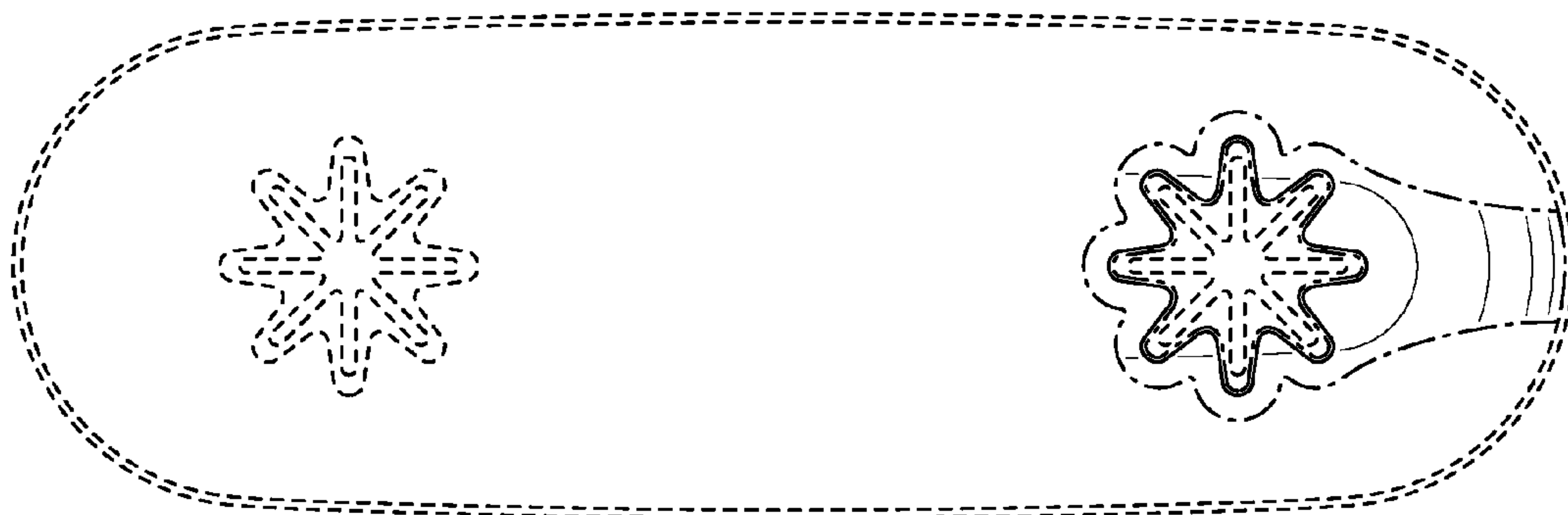

FIG. 16

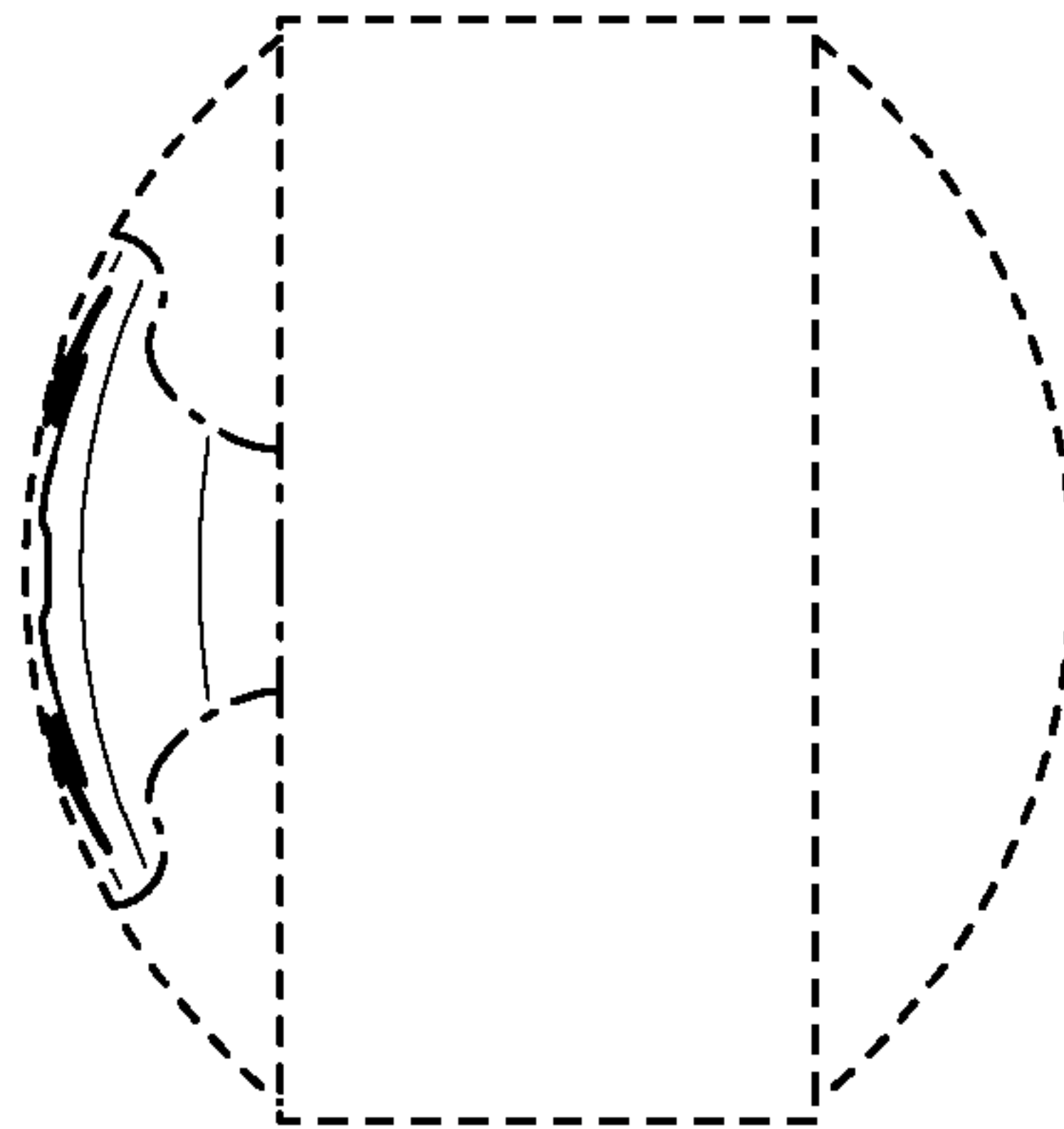

FIG. 17

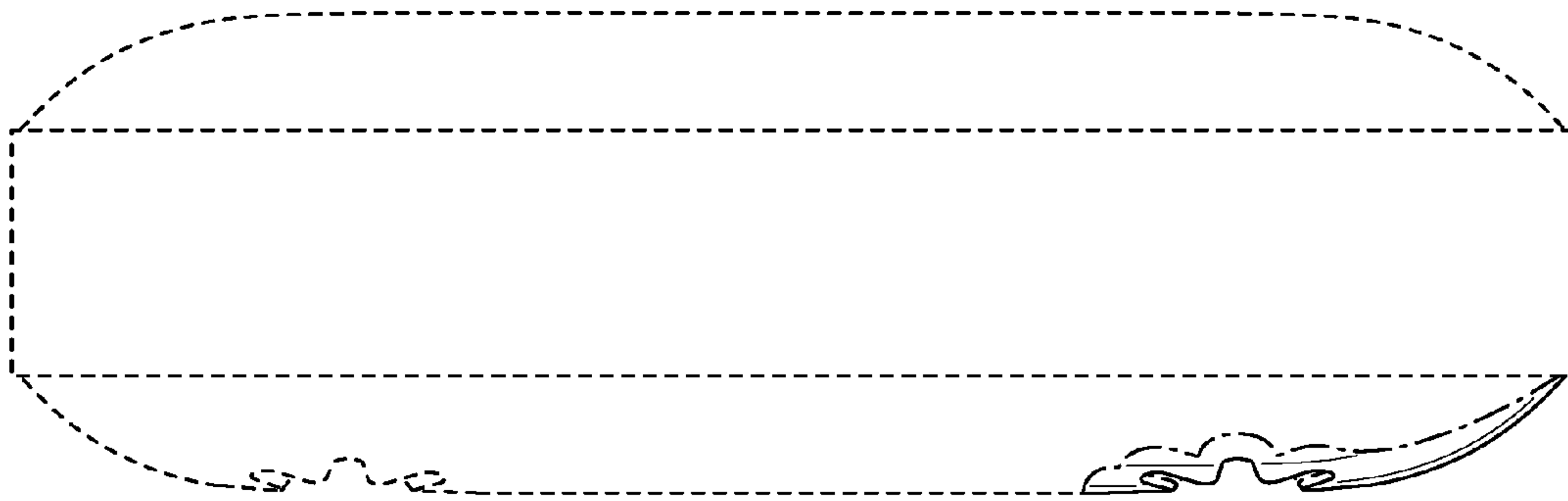

FIG. 18

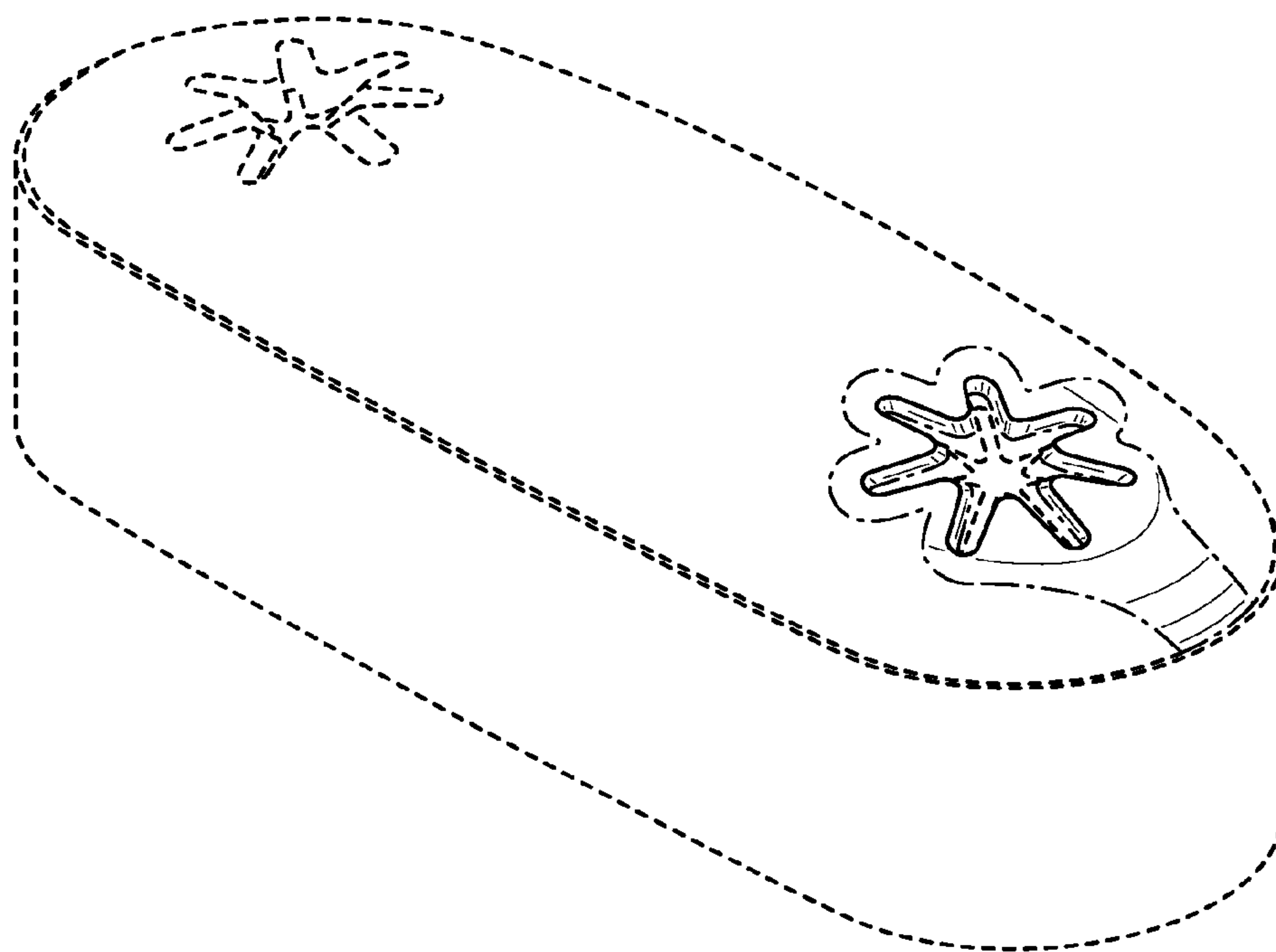

FIG. 19

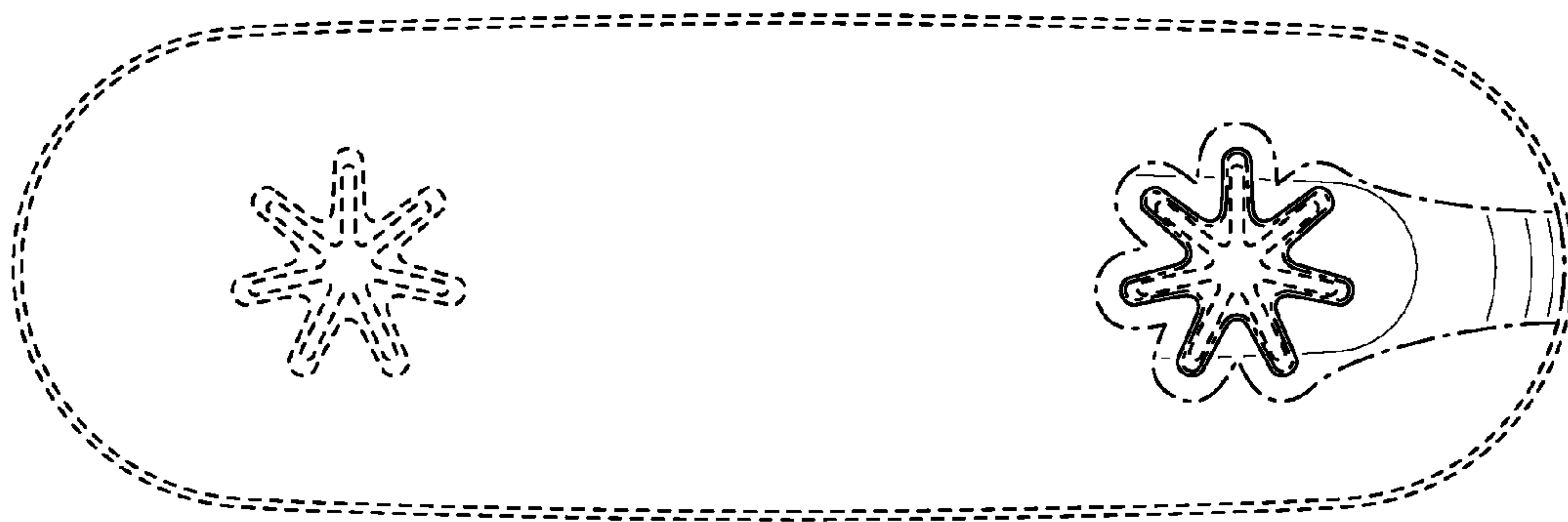

FIG. 20

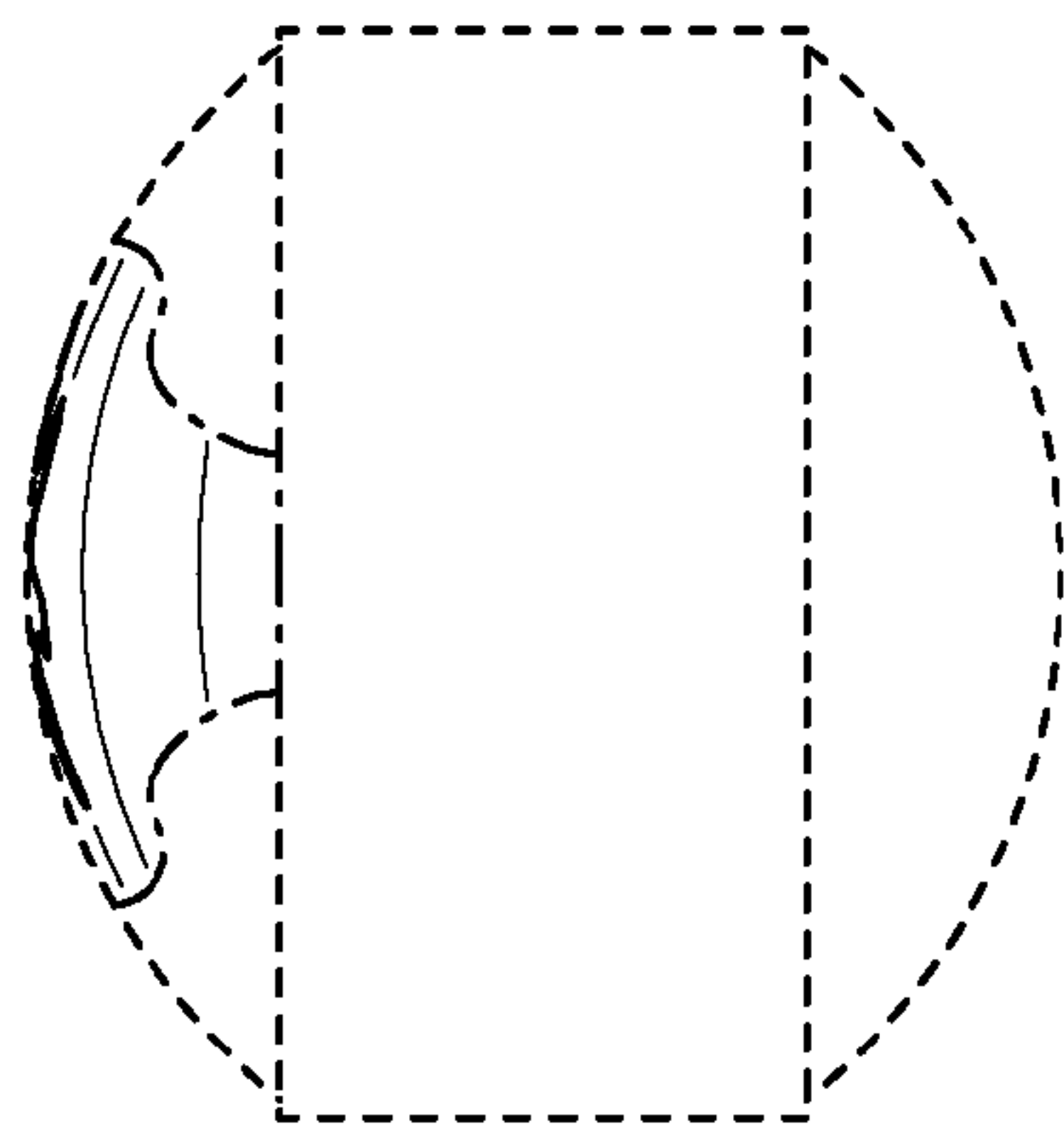

FIG. 21

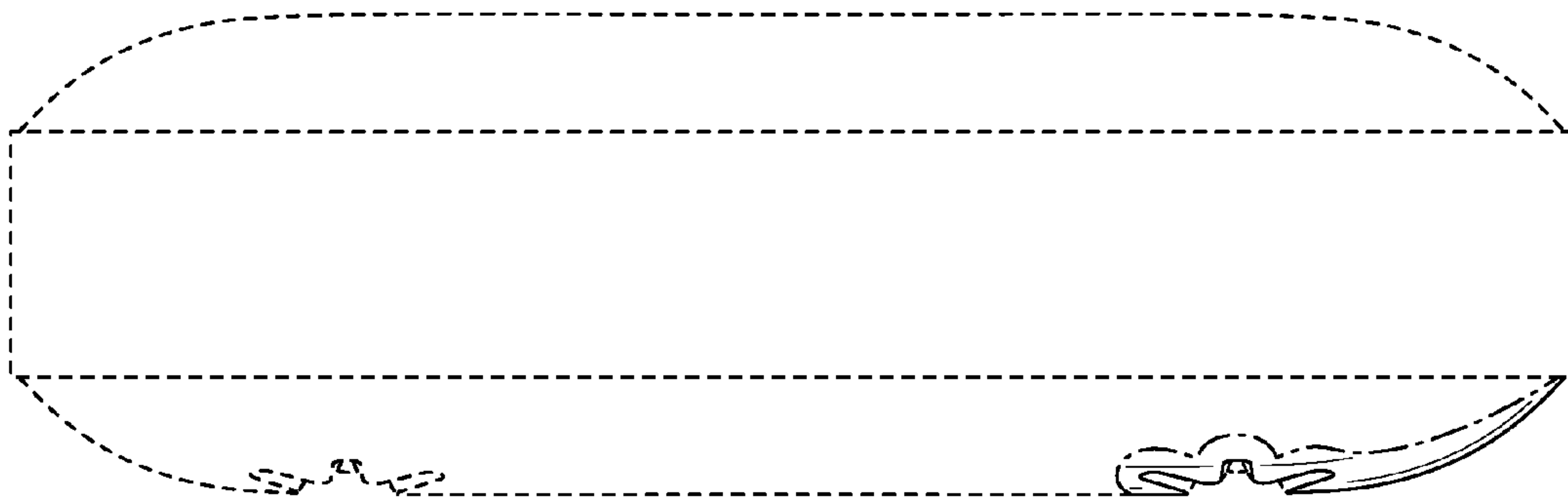

FIG. 22

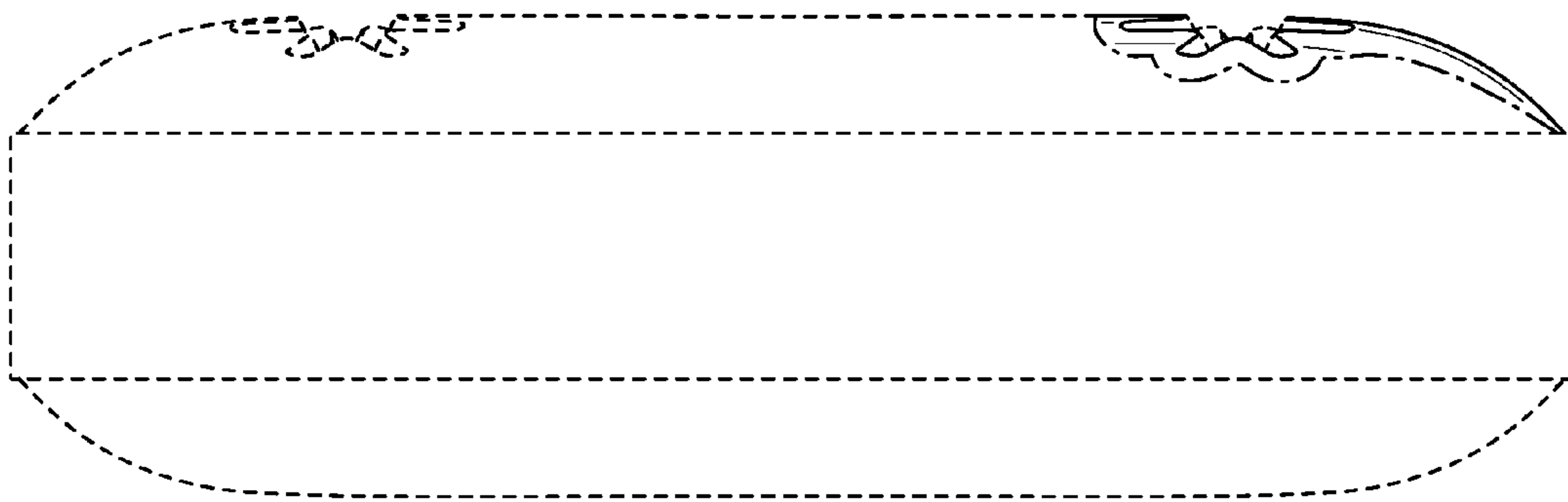

FIG. 23

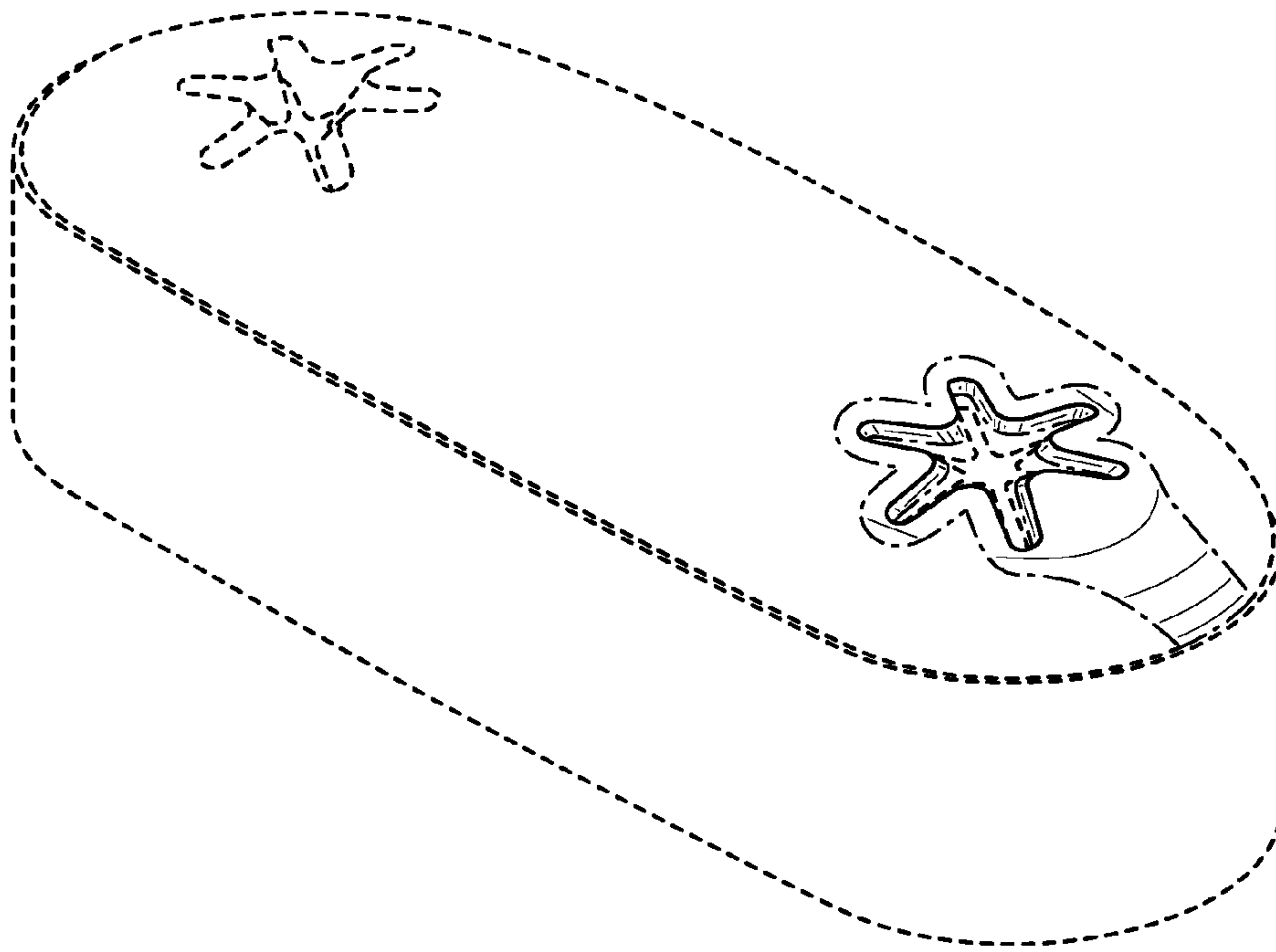

FIG. 24



FIG. 25

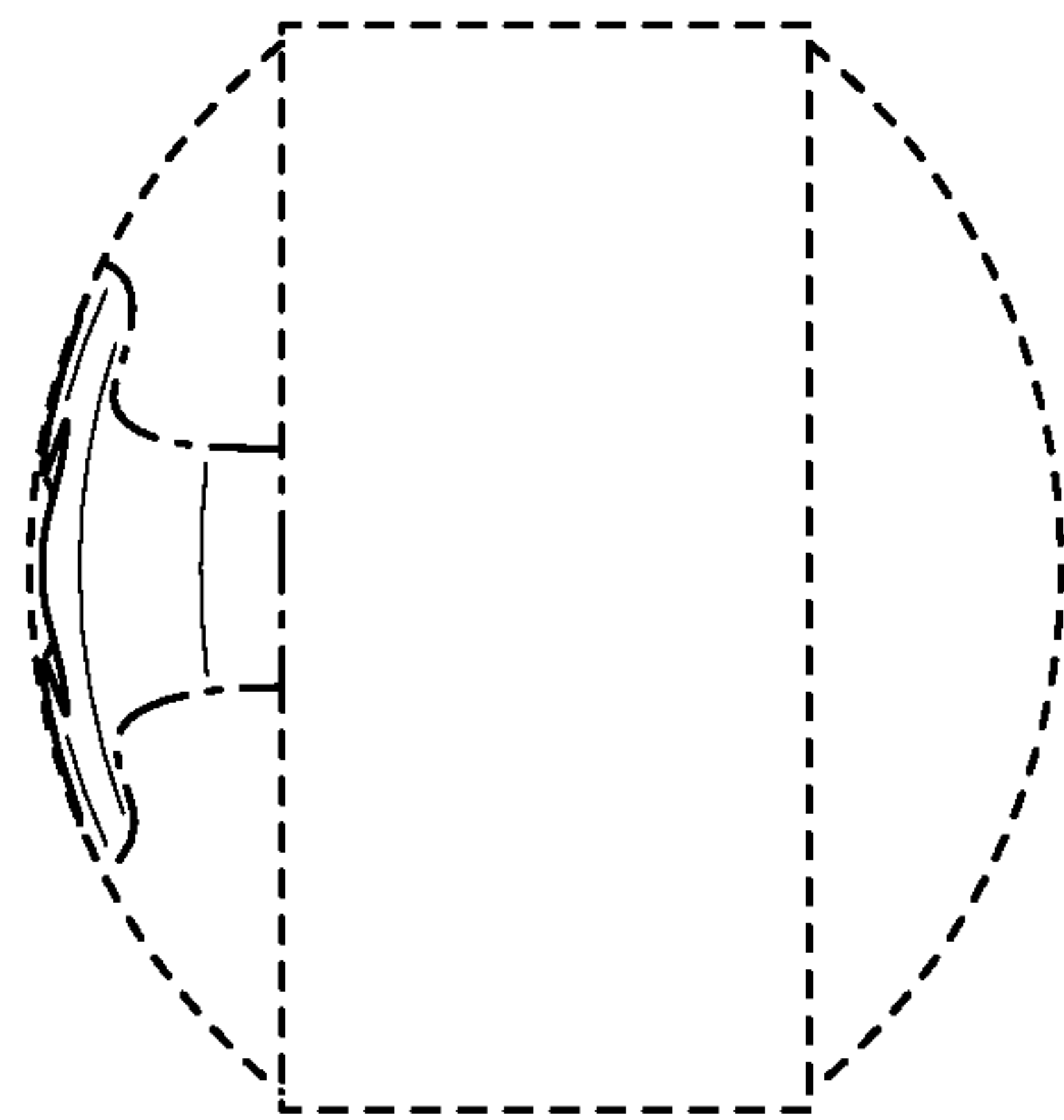

FIG. 26

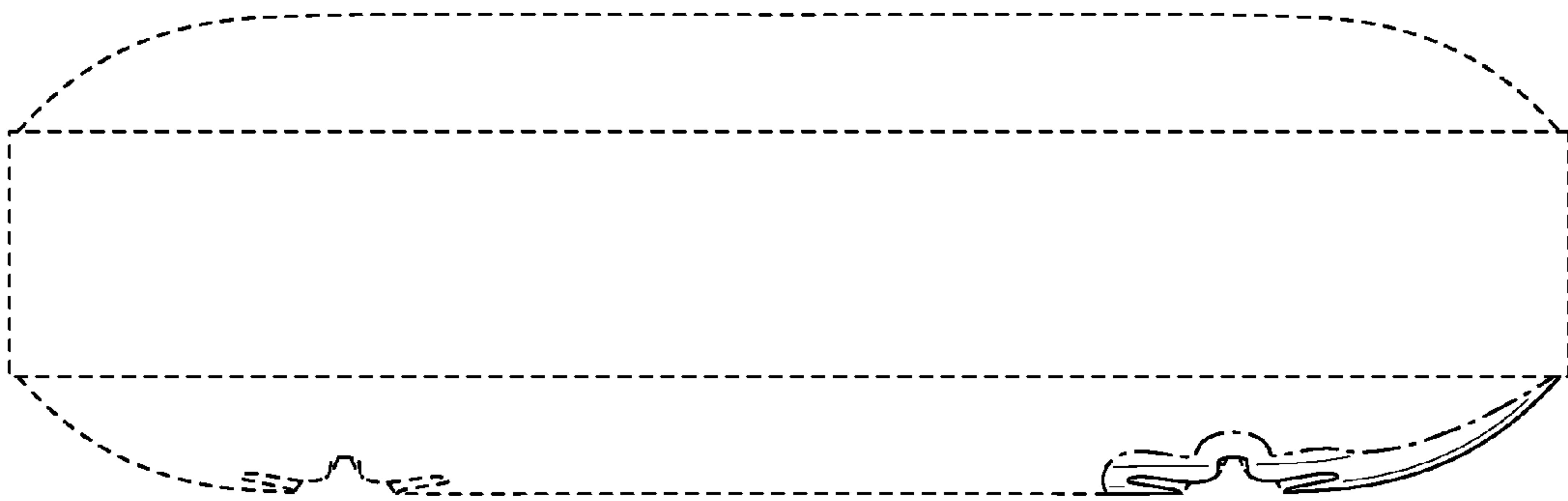

FIG. 27

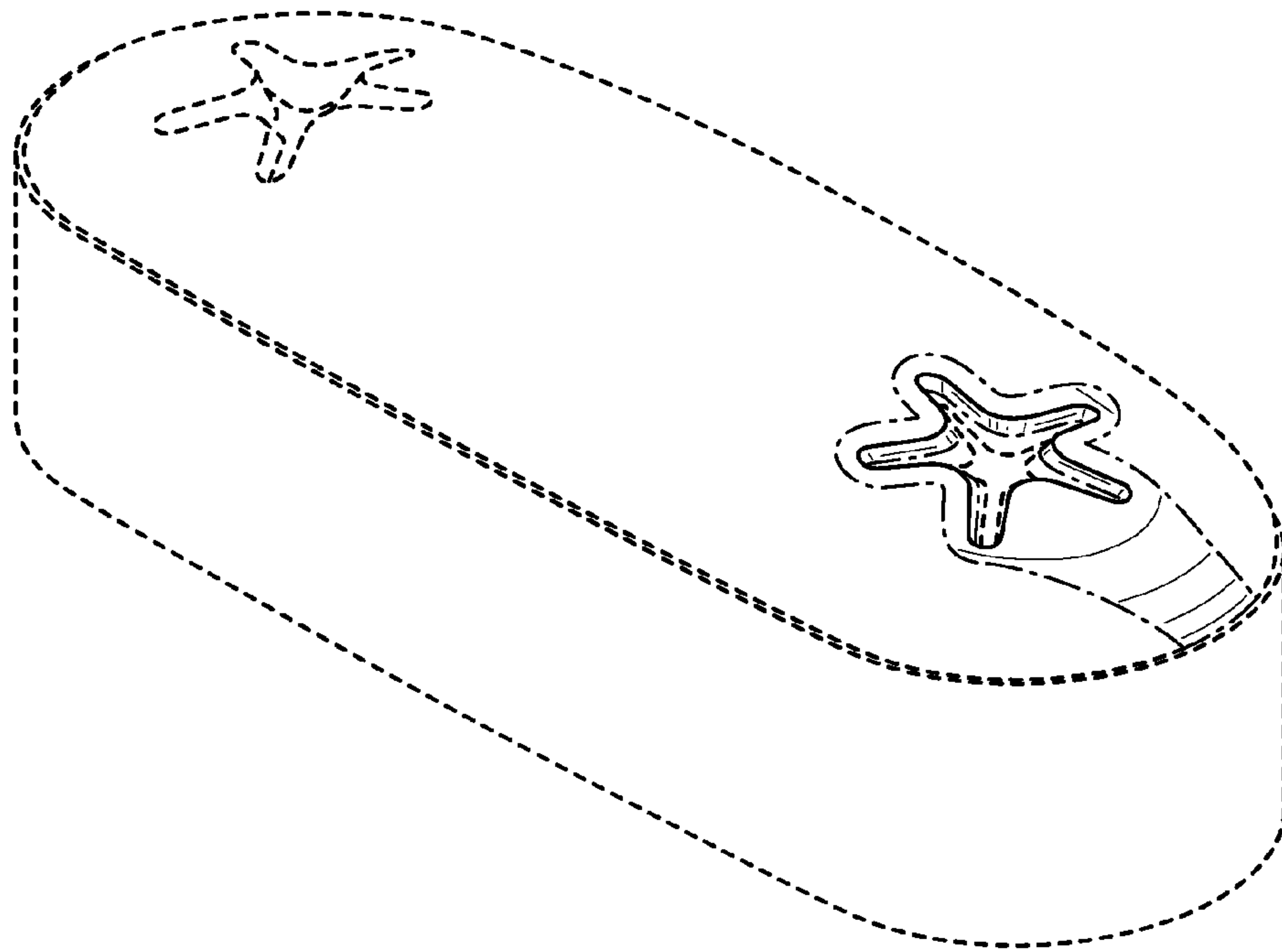

FIG. 28

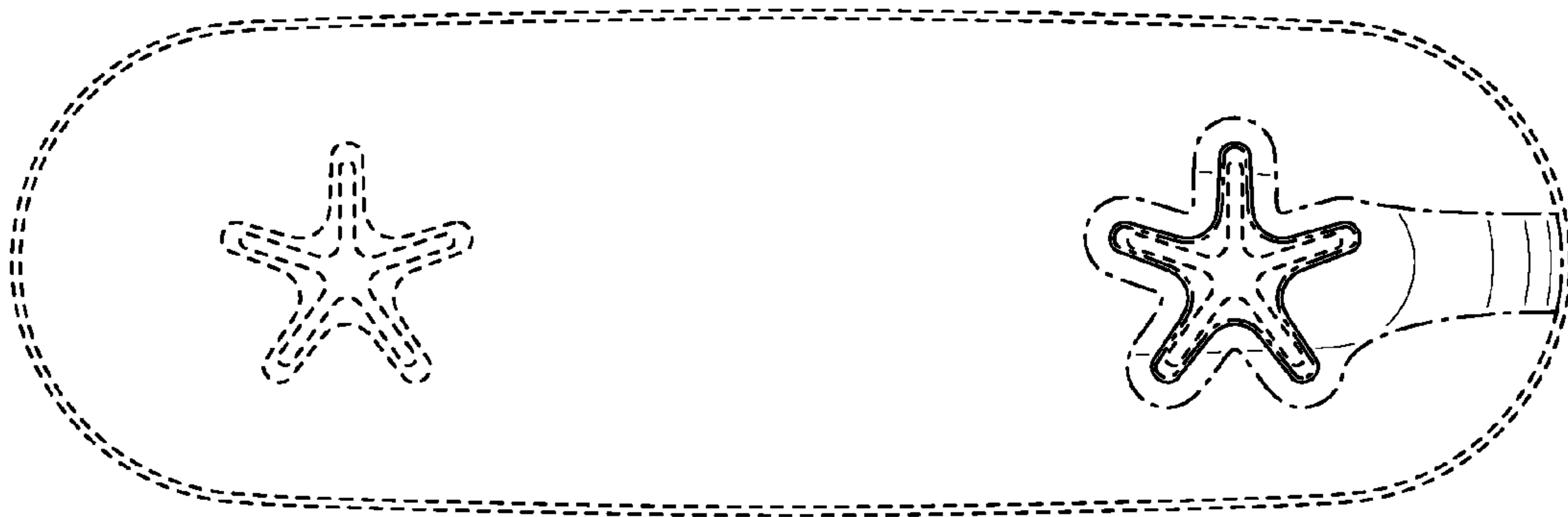

FIG. 29

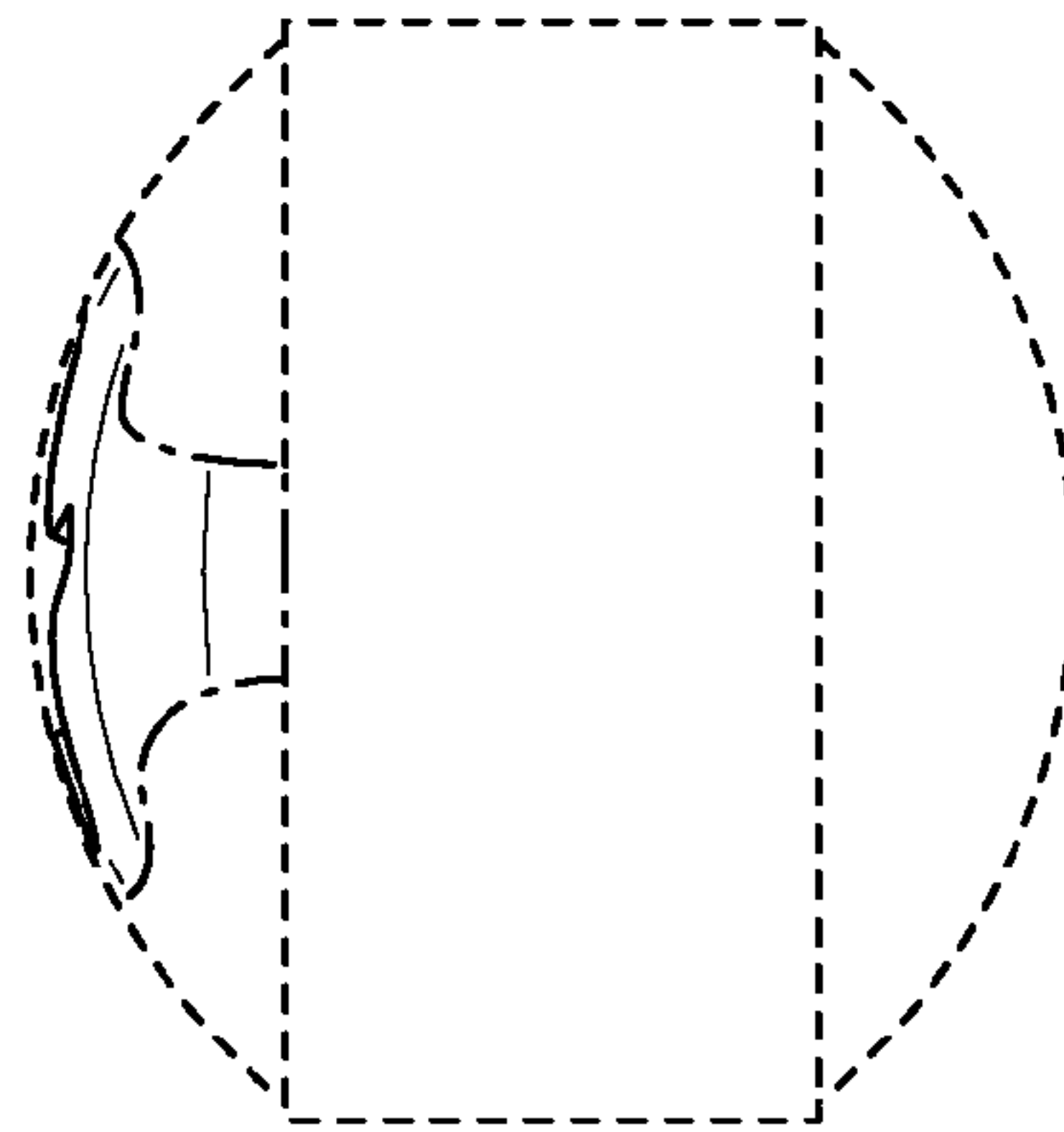

FIG. 30

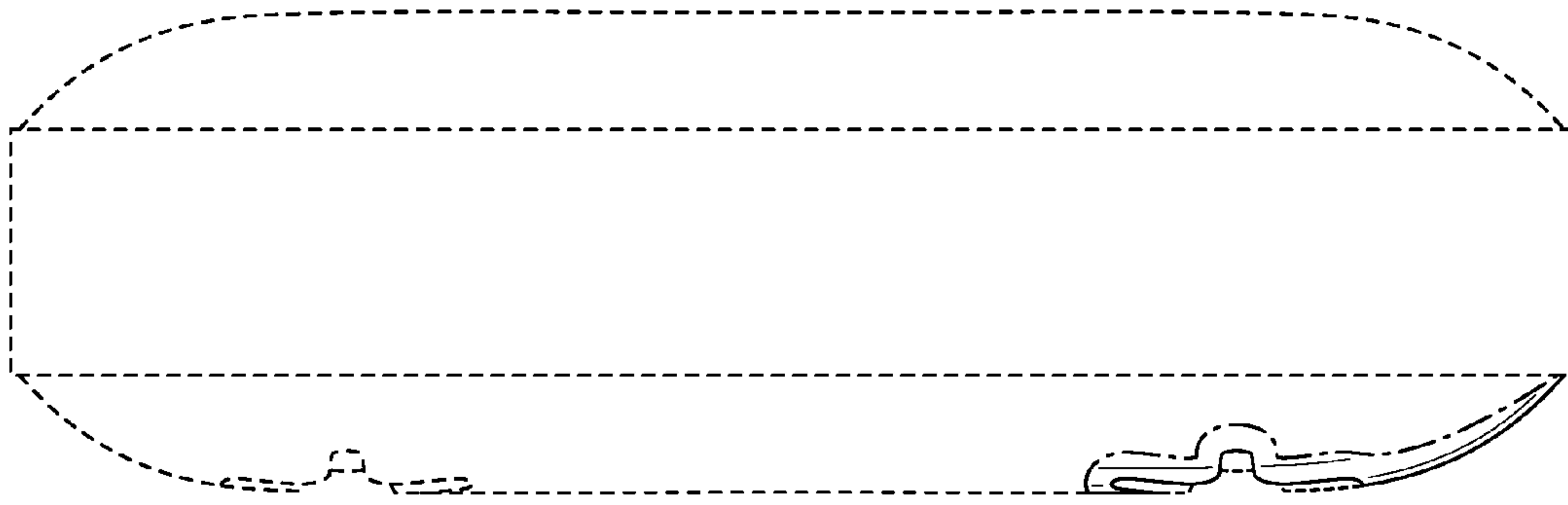

FIG. 31

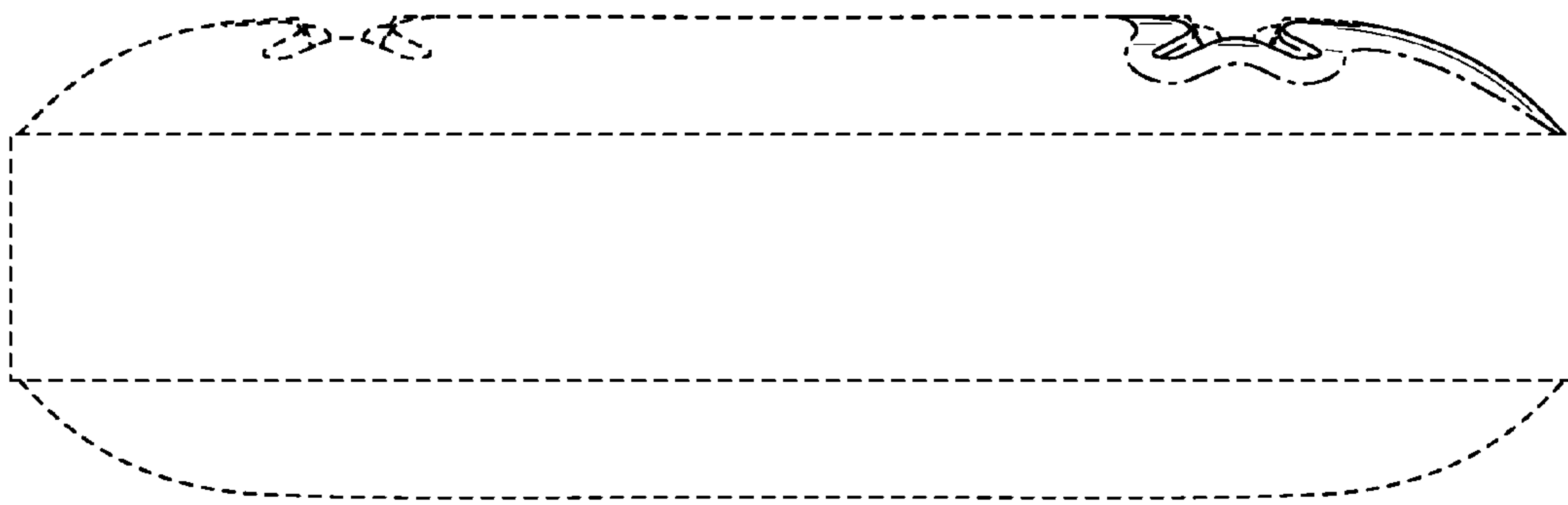

FIG. 32