



US00D754762S

(12) **United States Design Patent**  
**Schönherr et al.**

(10) **Patent No.:** **US D754,762 S**

(45) **Date of Patent:** **\*\* Apr. 26, 2016**

(54) **MACHINE ENCLOSURE**

(56) **References Cited**

(71) Applicant: **TRUMPF GmbH + Co. KG**, Ditzingen (DE)

U.S. PATENT DOCUMENTS

(72) Inventors: **Tom Schönherr**, Stuttgart (DE);  
**Andreas Diefenbach**,  
Ludwigsburg-Ossweil (DE); **Dina Gallo**,  
Stuttgart (DE)

3,049,837	A *	8/1962	Freeman	.....	451/86
4,558,650	A *	12/1985	Berman	.....	109/24.1
5,036,779	A *	8/1991	Capraro	.....	109/24.1
D459,370	S *	6/2002	Beadel	.....	D15/124
D464,066	S *	10/2002	Smith et al.	.....	D15/133
7,411,153	B2 *	8/2008	Radtke	.....	219/130.1
D658,687	S *	5/2012	Theissen	.....	D15/122
8,201,480	B2 *	6/2012	Nichols et al.	.....	74/813 R

(73) Assignee: **TRUMPF GmbH + Co. KG**, Ditzingen (DE)

\* cited by examiner

(\*\*) Term: **14 Years**

*Primary Examiner* — Patricia Palasik

(21) Appl. No.: **29/510,308**

(57) **CLAIM**

The ornamental design for a machine enclosure, substantially as shown and described.

(22) Filed: **Nov. 26, 2014**

**DESCRIPTION**

(30) **Foreign Application Priority Data**

May 28, 2014 (EM) ..... 002472712-0004

May 28, 2014 (EM) ..... 002472712-0007

(51) **LOC (10) Cl.** ..... **15-09**

(52) **U.S. Cl.**  
USPC ..... **D15/122**

(58) **Field of Classification Search**  
USPC ..... D15/122, 128, 129, 130, 131, 141  
See application file for complete search history.

FIG. 1 is a perspective view of our design.  
FIG. 2 is a front view of our design.  
FIG. 3 is a rear view of our design.  
FIG. 4 is a left side view of our design.  
FIG. 5 is a right side view of our design.  
FIG. 6 is a top view of our design; and,  
FIG. 7 is a bottom view of our design.  
The broken lines in the drawings depict the boundaries of the claimed design and form no part thereof.

**1 Claim, 5 Drawing Sheets**

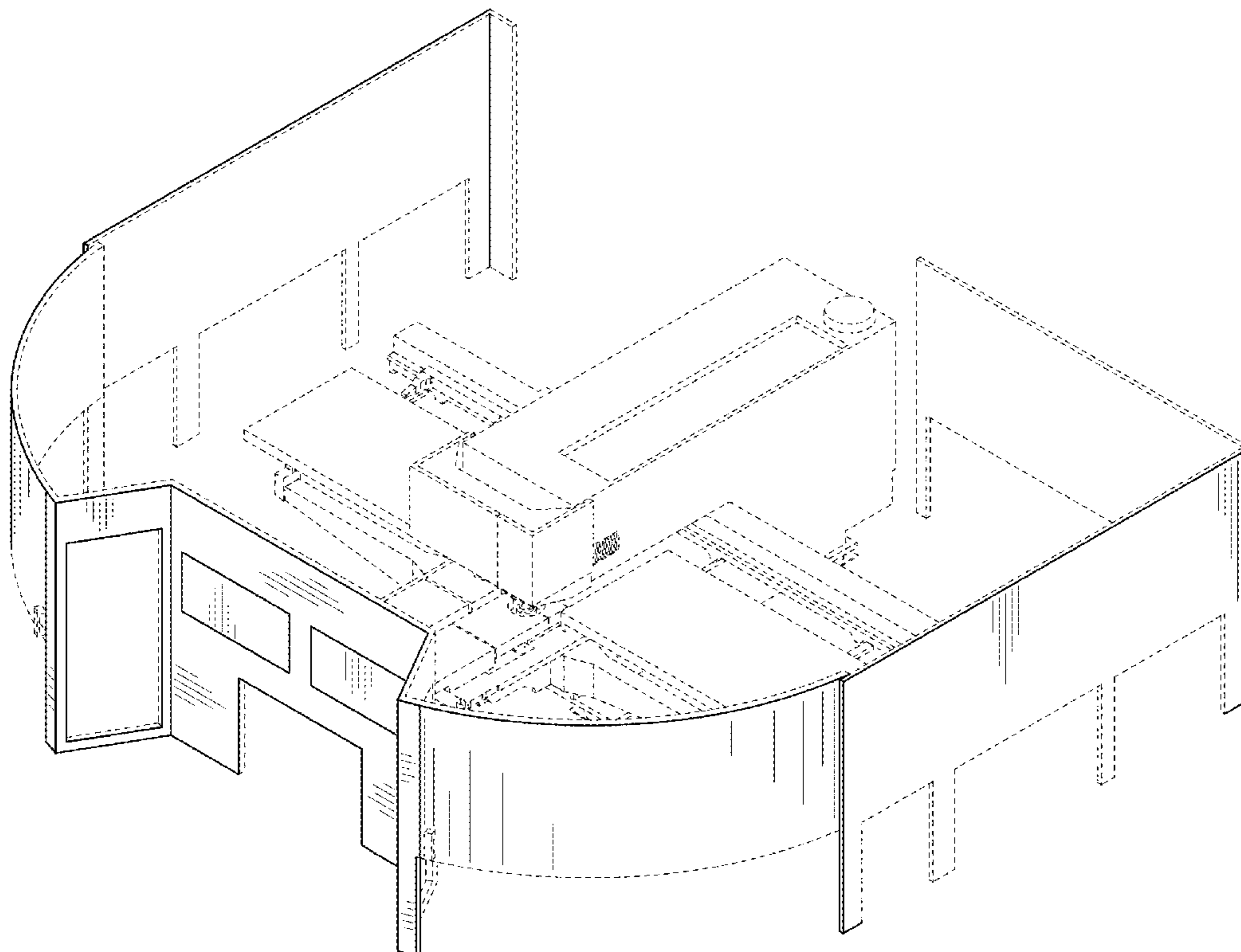

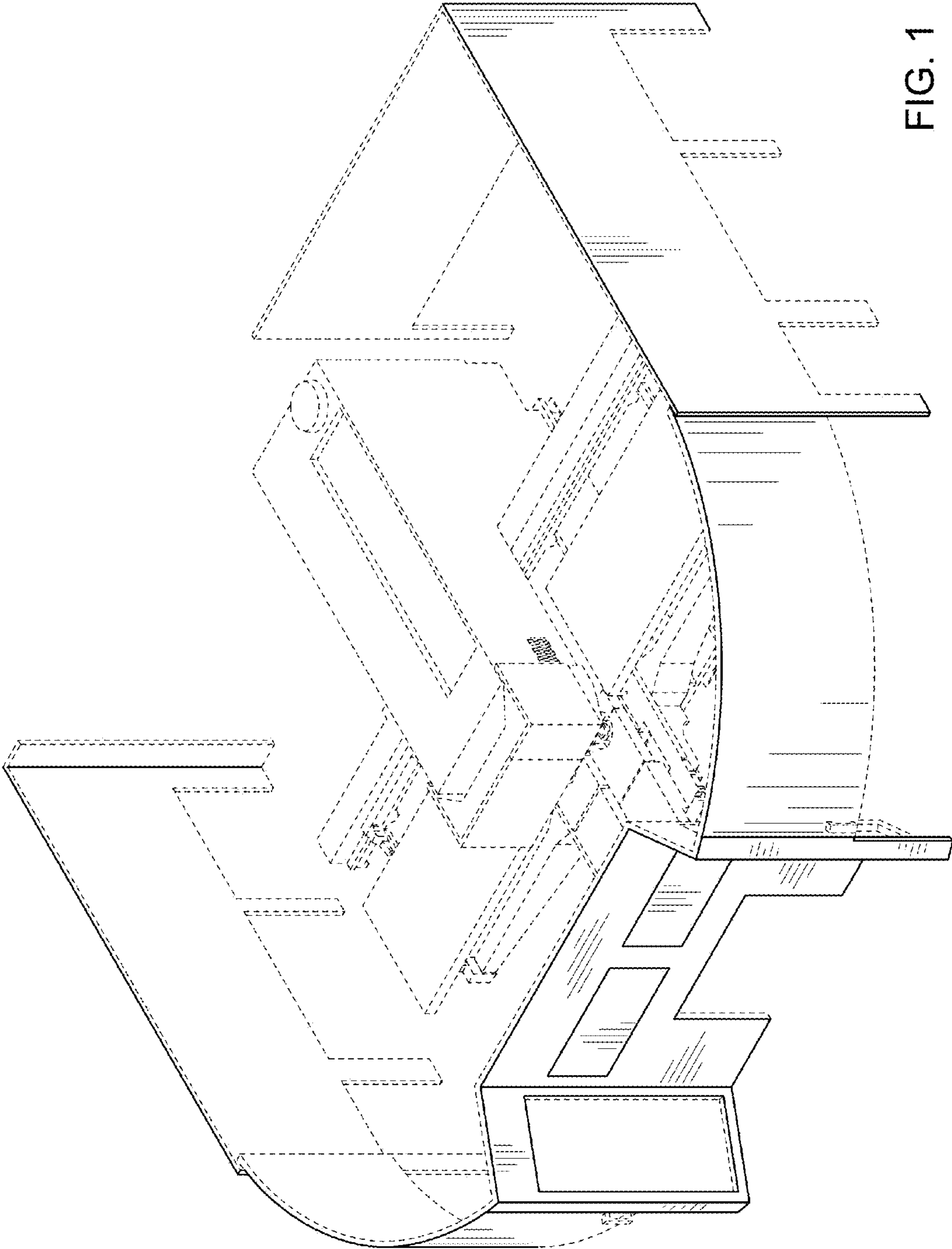

FIG. 1

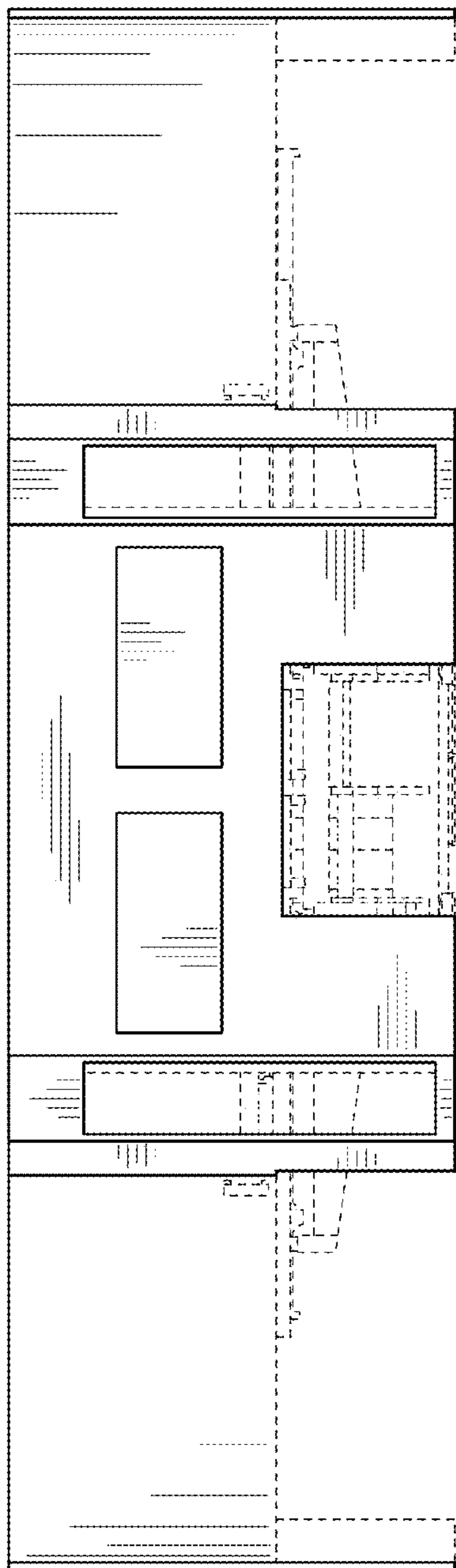

FIG. 2

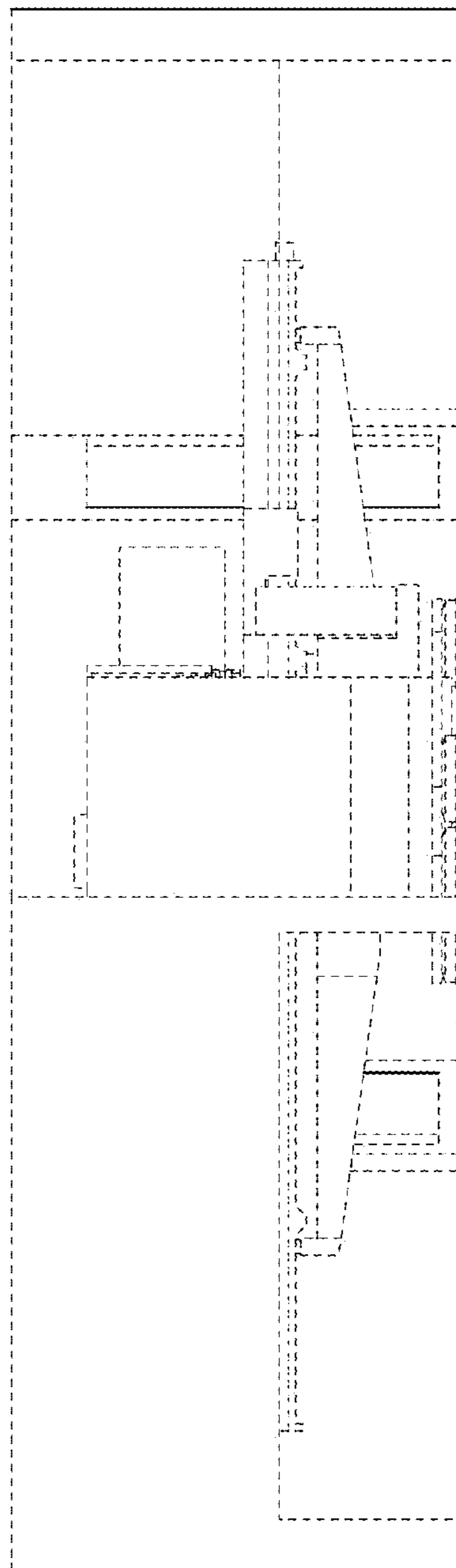

FIG. 3

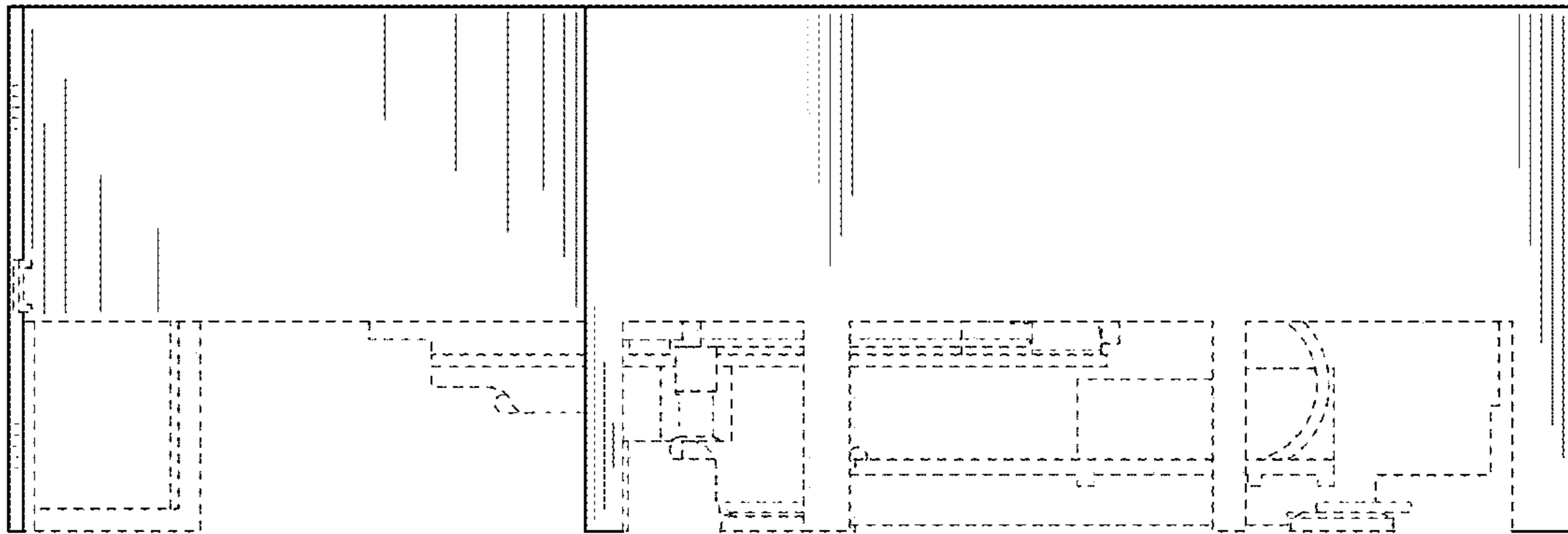

FIG. 4

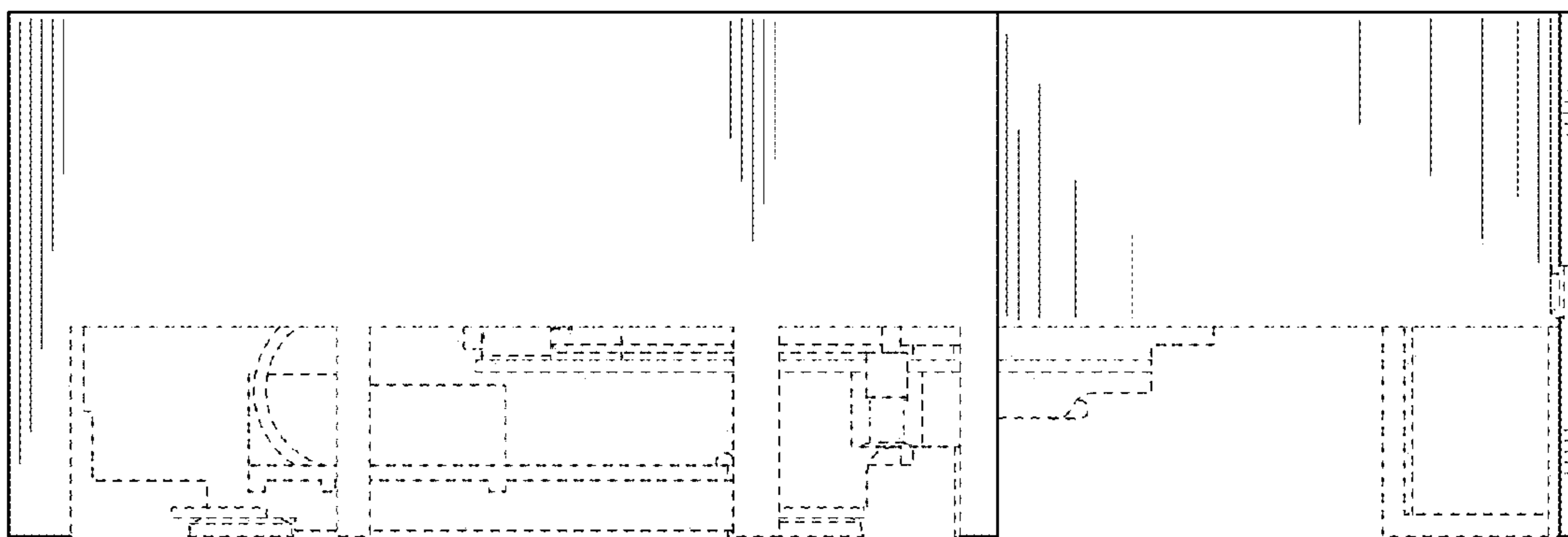

FIG. 5

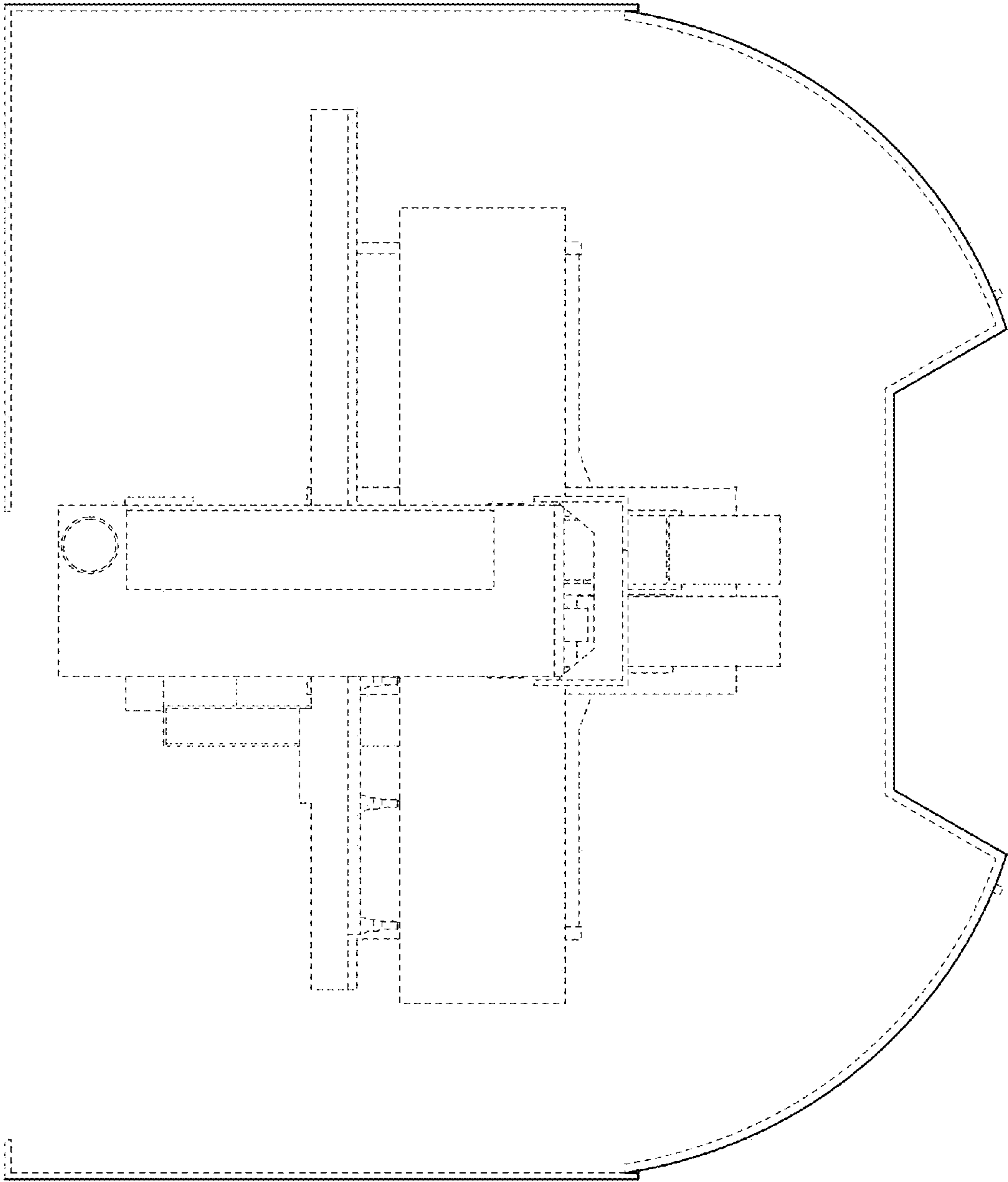

FIG. 6

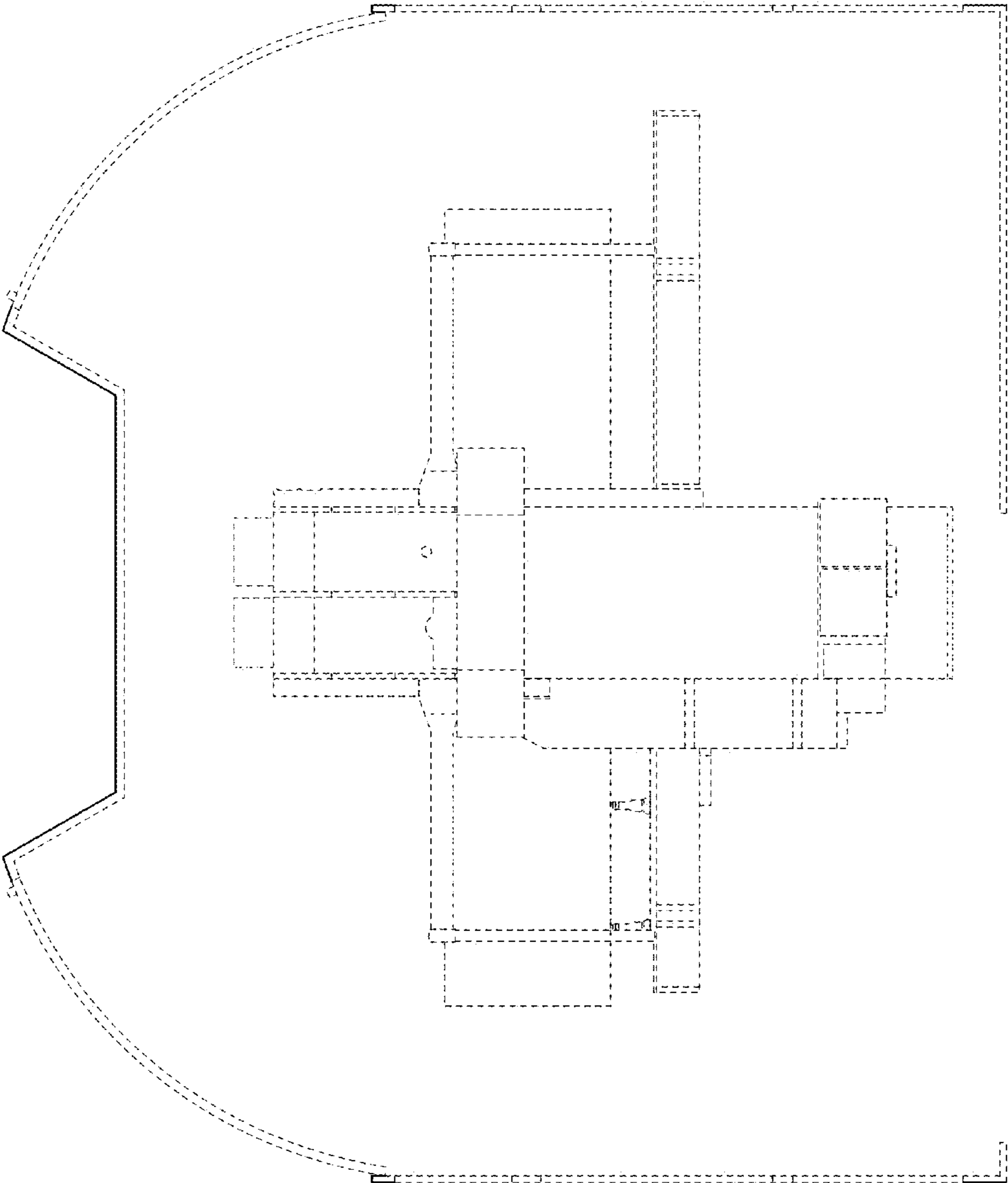

FIG. 7