



US00D754639S

(12) **United States Design Patent**
Wu et al.

(10) **Patent No.:** **US D754,639 S**
(45) **Date of Patent:** **** Apr. 26, 2016**

- (54) **COMMUNICATIONS HEADSET**
- (71) Applicant: **Plantronics, Inc.**, Santa Cruz, CA (US)
- (72) Inventors: **Chang-Chih Wu**, Taipei (TW);
Hsu-Yang Wei, Taipei (TW);
Shao-Chun Sung, Taipei (TW)
- (73) Assignee: **Plantronics, Inc.**, Santa Cruz, CA (US)
- (**) Term: **14 Years**
- (21) Appl. No.: **29/501,381**
- (22) Filed: **Sep. 3, 2014**
- (51) **LOC (10) Cl.** **14-01**
- (52) **U.S. Cl.**
USPC **D14/223**
- (58) **Field of Classification Search**
USPC D14/223, 205, 240, 138 AA, 138 AB;
181/129, 130, 135; 379/430, 431;
381/380, 381
CPC H04R 25/00
See application file for complete search history.

(56) **References Cited**

U.S. PATENT DOCUMENTS

4,949,081	A *	8/1990	Keller et al.	345/33
6,590,566	B2 *	7/2003	Abe	345/168
D538,271	S *	3/2007	Kim et al.	D14/223
D538,792	S *	3/2007	Kim et al.	D14/223
D542,267	S *	5/2007	Cha et al.	D14/206
D565,033	S *	3/2008	Goransson	D14/223
D568,301	S *	5/2008	Kim et al.	D14/223
D569,289	S *	5/2008	Bender	D10/104.1
D580,900	S *	11/2008	Wong	D14/138 AA
D588,564	S *	3/2009	Pegon	D14/138 AA
D602,894	S *	10/2009	Lepoultier et al.	D14/138 AB
D609,698	S *	2/2010	Ng	D14/223

D620,927	S *	8/2010	Li	D14/223
7,778,410	B2 *	8/2010	Liu et al.	379/430
D625,710	S	10/2010	Yang		
D625,711	S	10/2010	Yang		
D625,712	S	10/2010	Yang		
D625,713	S	10/2010	Yang		
D631,037	S *	1/2011	Park et al.	D14/223
D637,184	S *	5/2011	March	D14/223
D640,242	S *	6/2011	Fahrendorff et al.	D14/223
D649,957	S *	12/2011	Fahrendorff et al.	D14/223
D657,781	S	4/2012	Yang		
D664,950	S *	8/2012	Rye et al.	D14/223
D675,600	S	2/2013	Koch		
D680,101	S	4/2013	Koch		
D726,693	S *	4/2015	Behar et al.	D14/223
D730,892	S *	6/2015	Lee	D14/138 G

* cited by examiner

Primary Examiner — Paula Greene

(57) **CLAIM**

The ornamental design for a communications headset, as shown and described.

DESCRIPTION

FIG. 1 is a top-left perspective view of a communications headset showing my new design;
 FIG. 2 is a top-right perspective view thereof;
 FIG. 3 is a top view thereof;
 FIG. 4 is a bottom view thereof;
 FIG. 5 is a back view thereof;
 FIG. 6 is a front view thereof;
 FIG. 7 is a right side view thereof; and,
 FIG. 8 is a left side view thereof.

The broken lines in the drawings, including those immediately adjacent to the shaded areas, represent unclaimed features of an exemplary headset in which the design is embodied; the broken lines form no part of the claimed design.

1 Claim, 6 Drawing Sheets

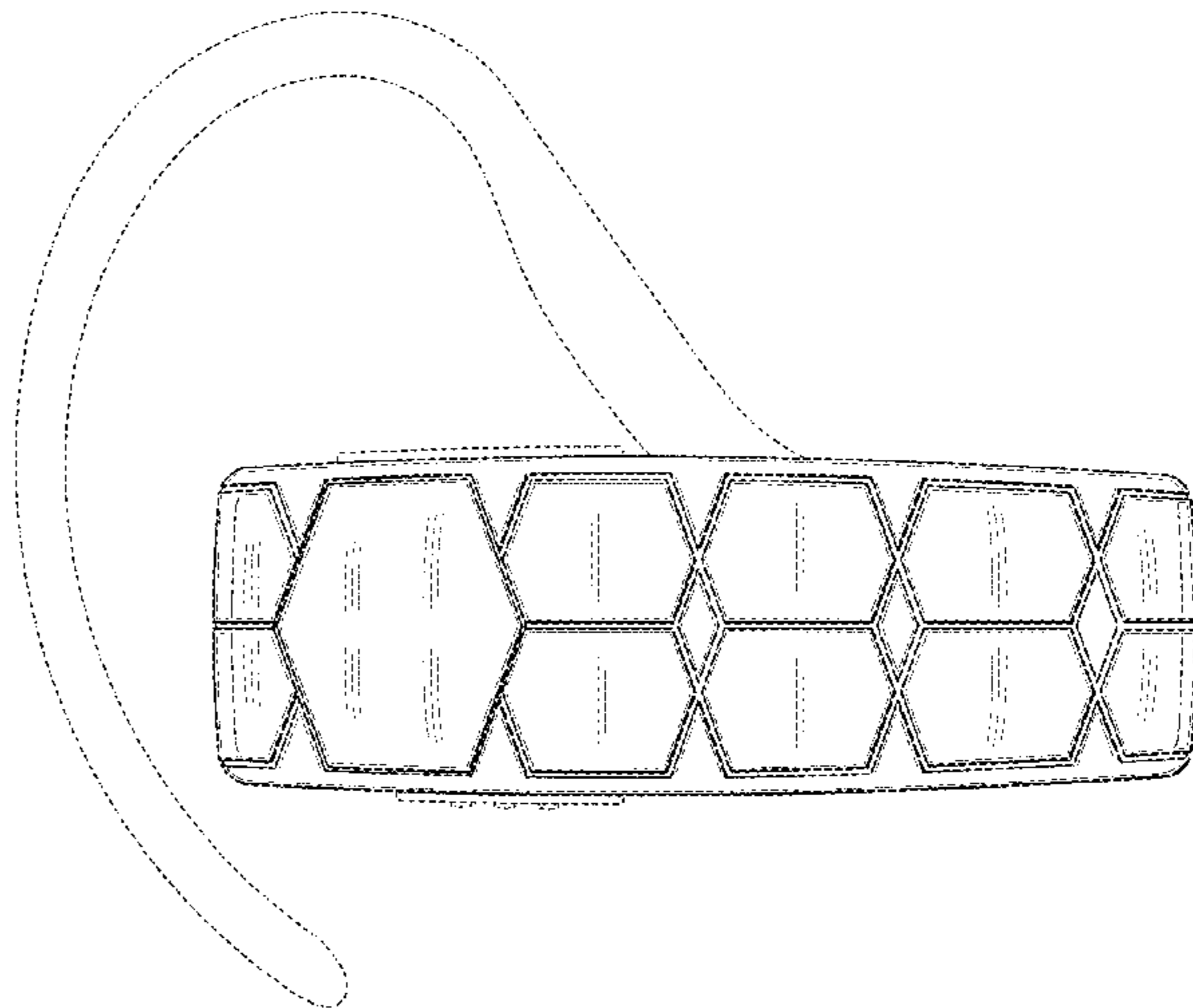
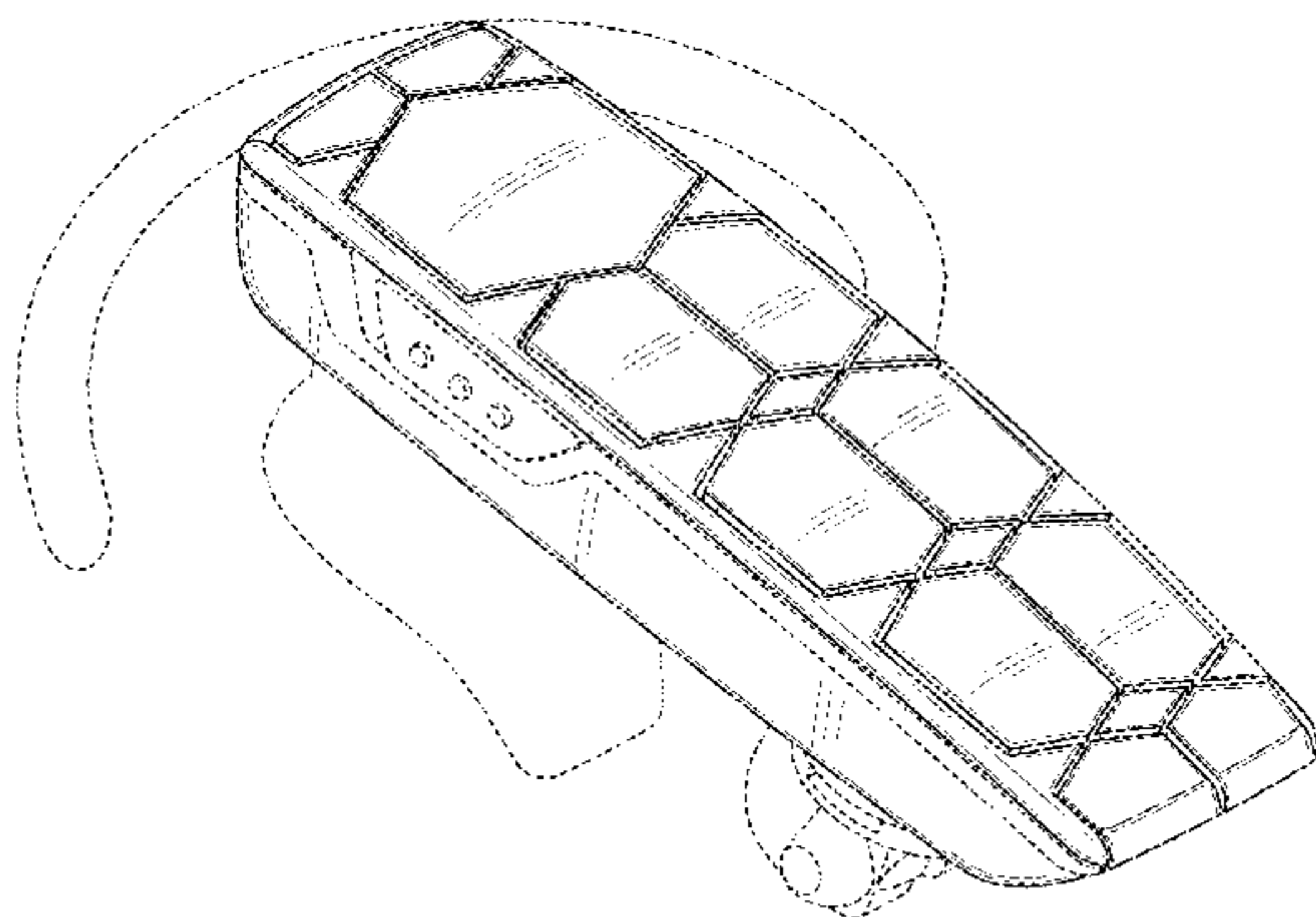

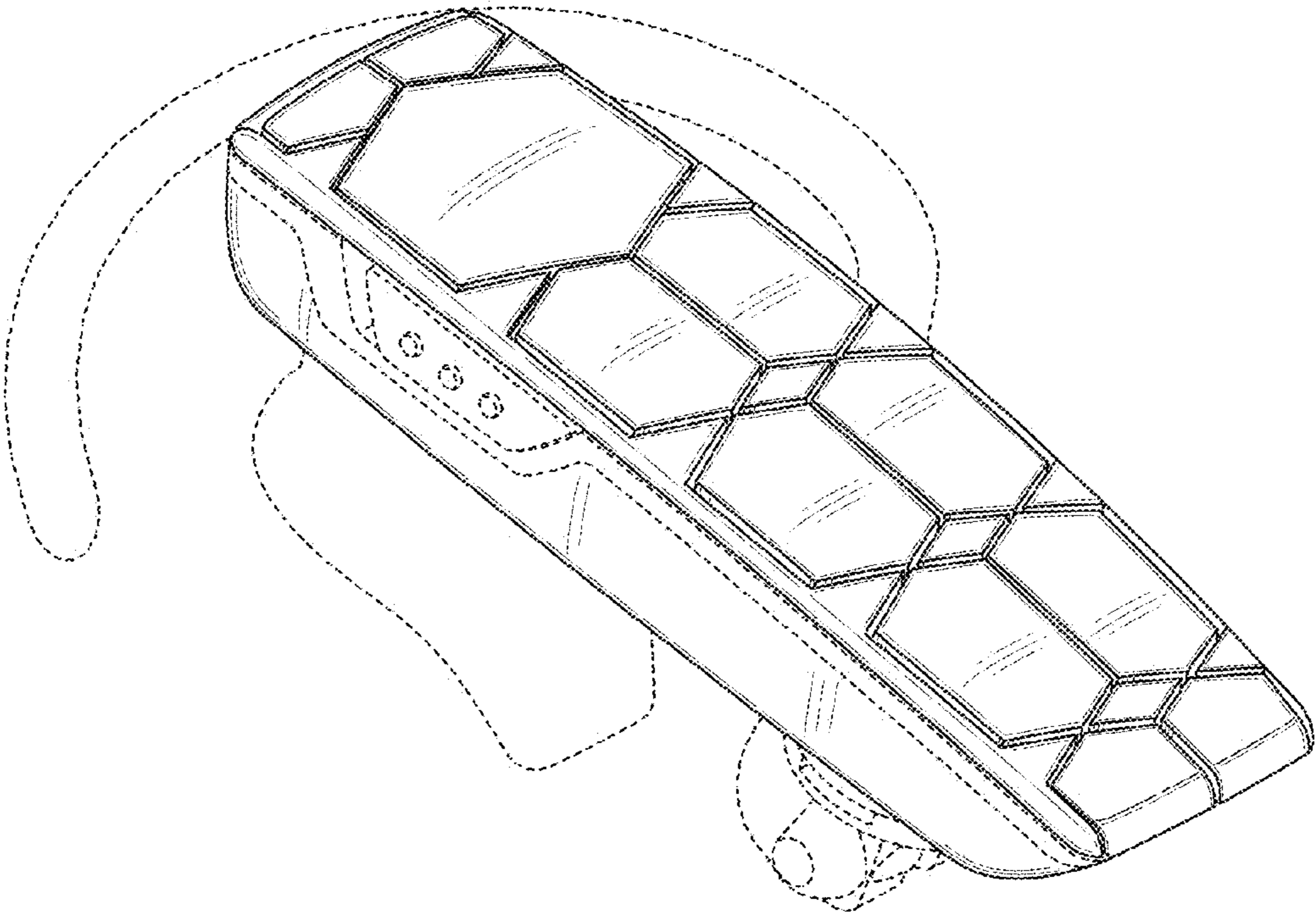

FIG. 1

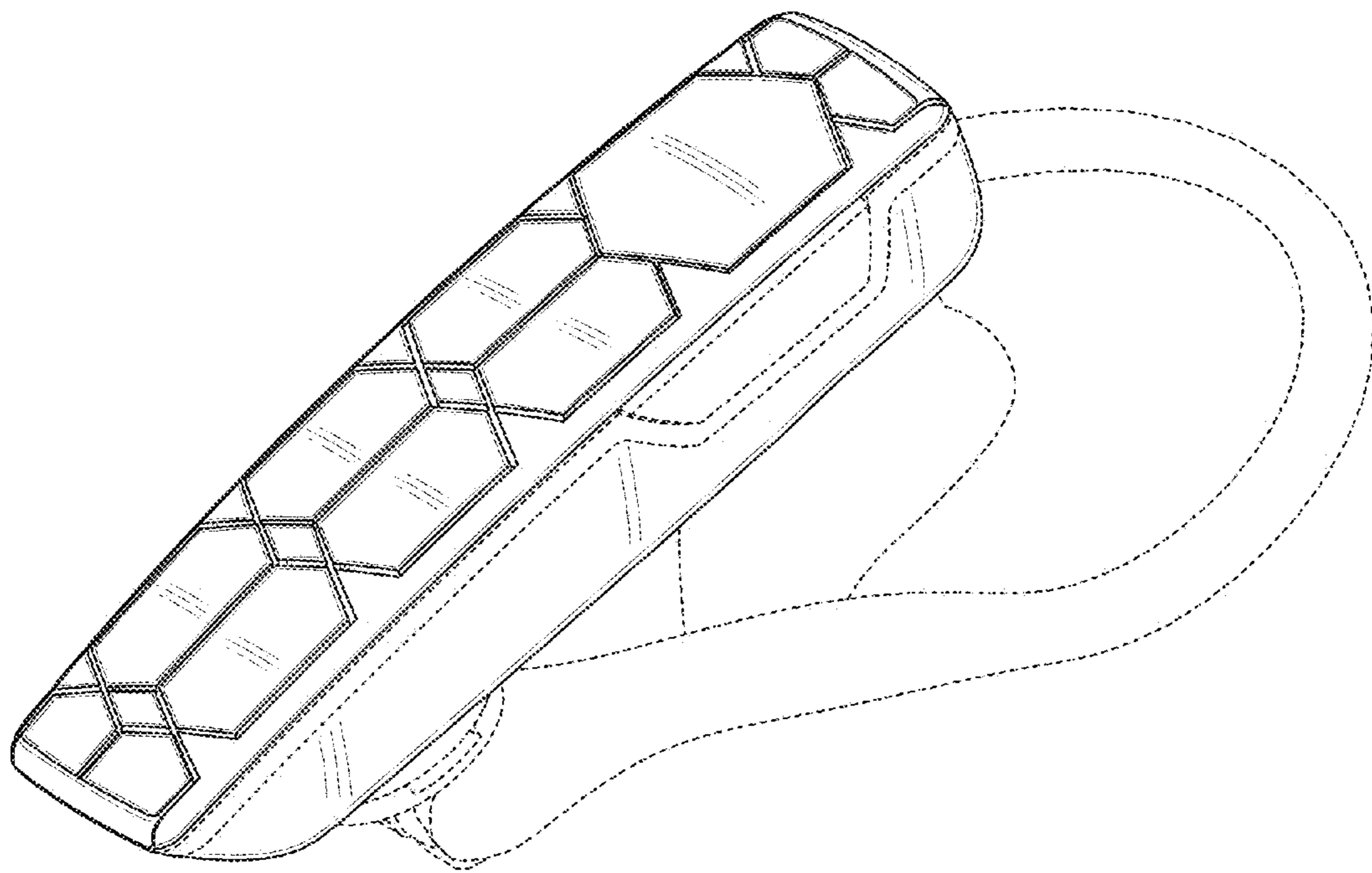

FIG. 2

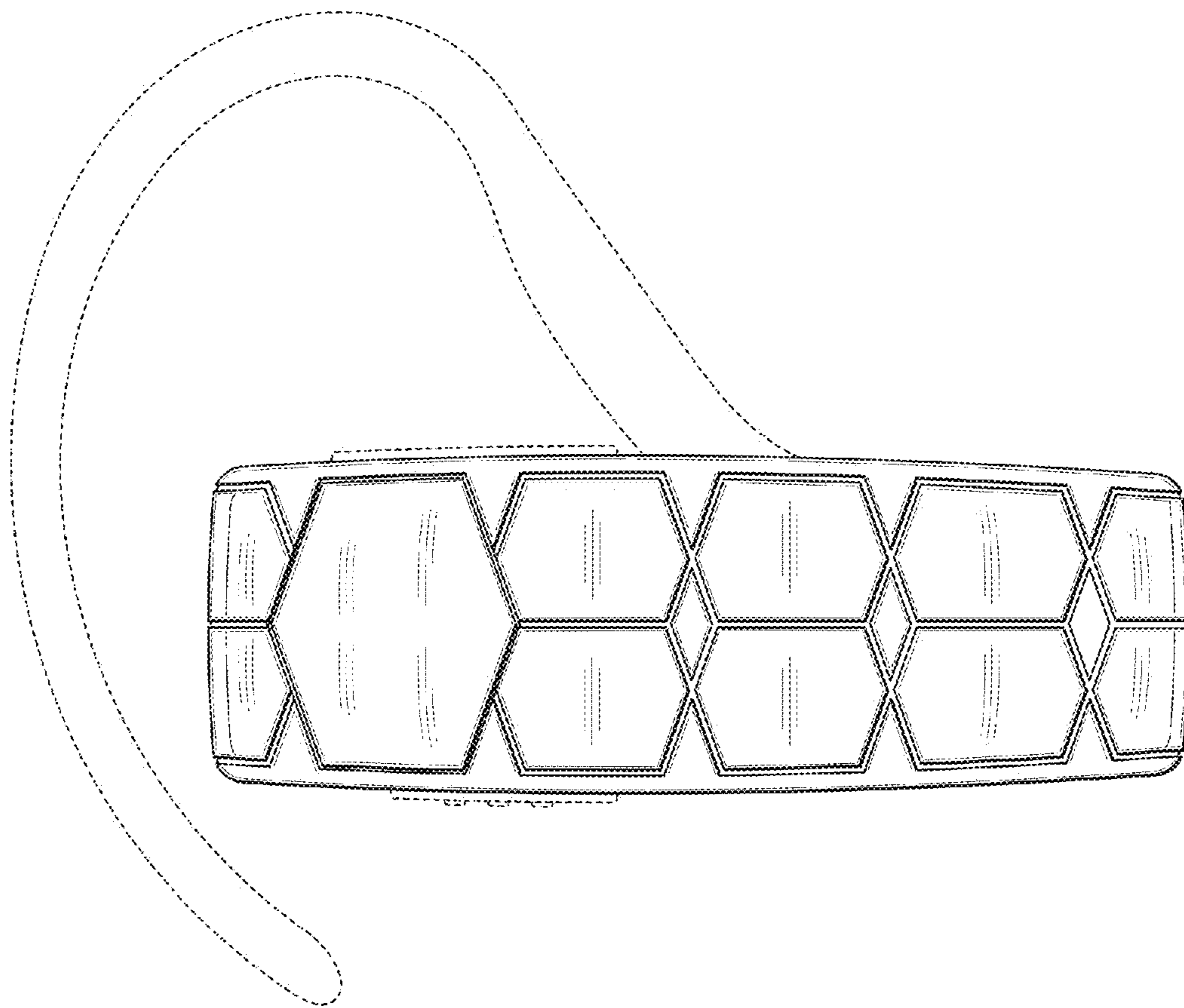

FIG. 3

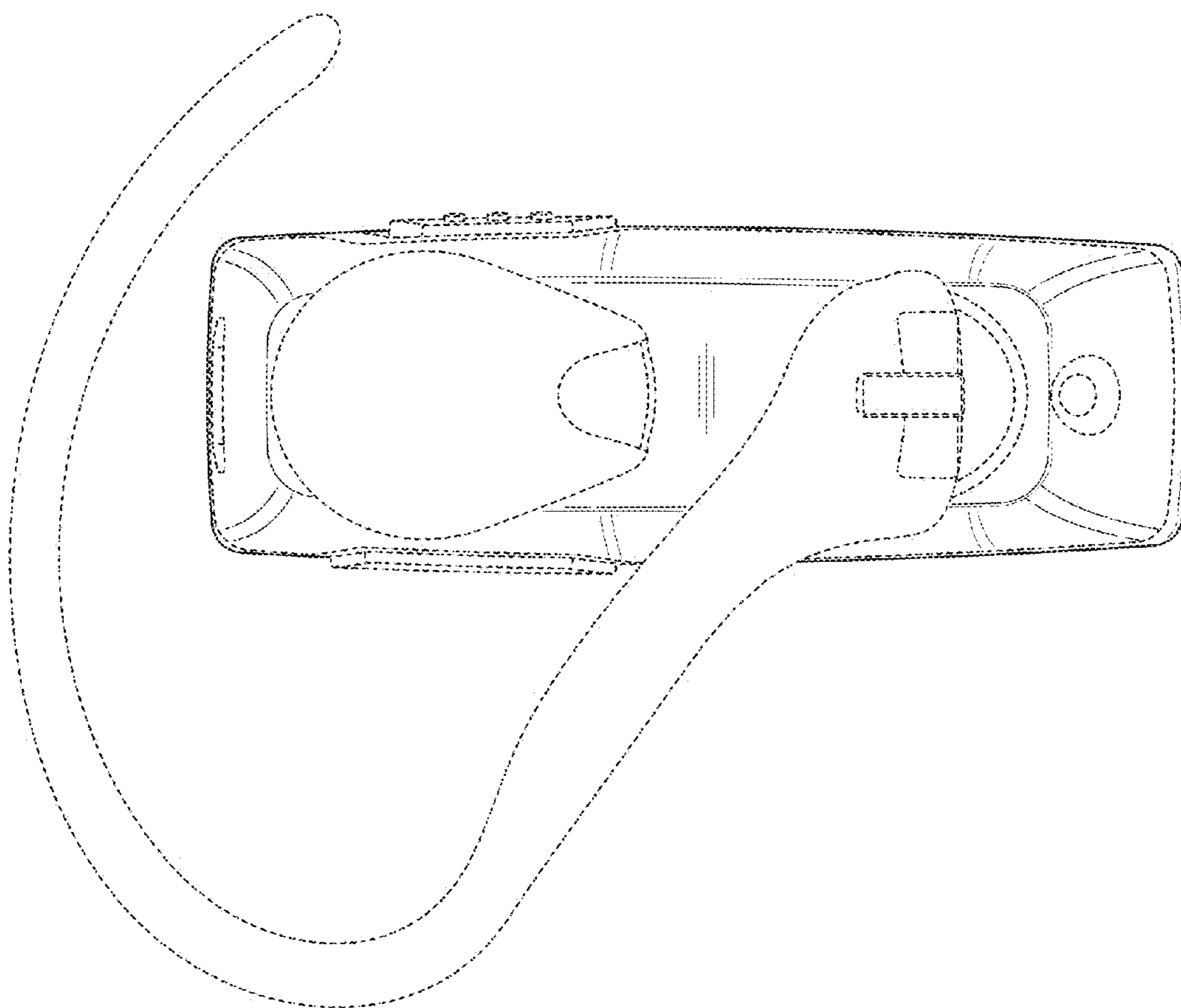

FIG. 4

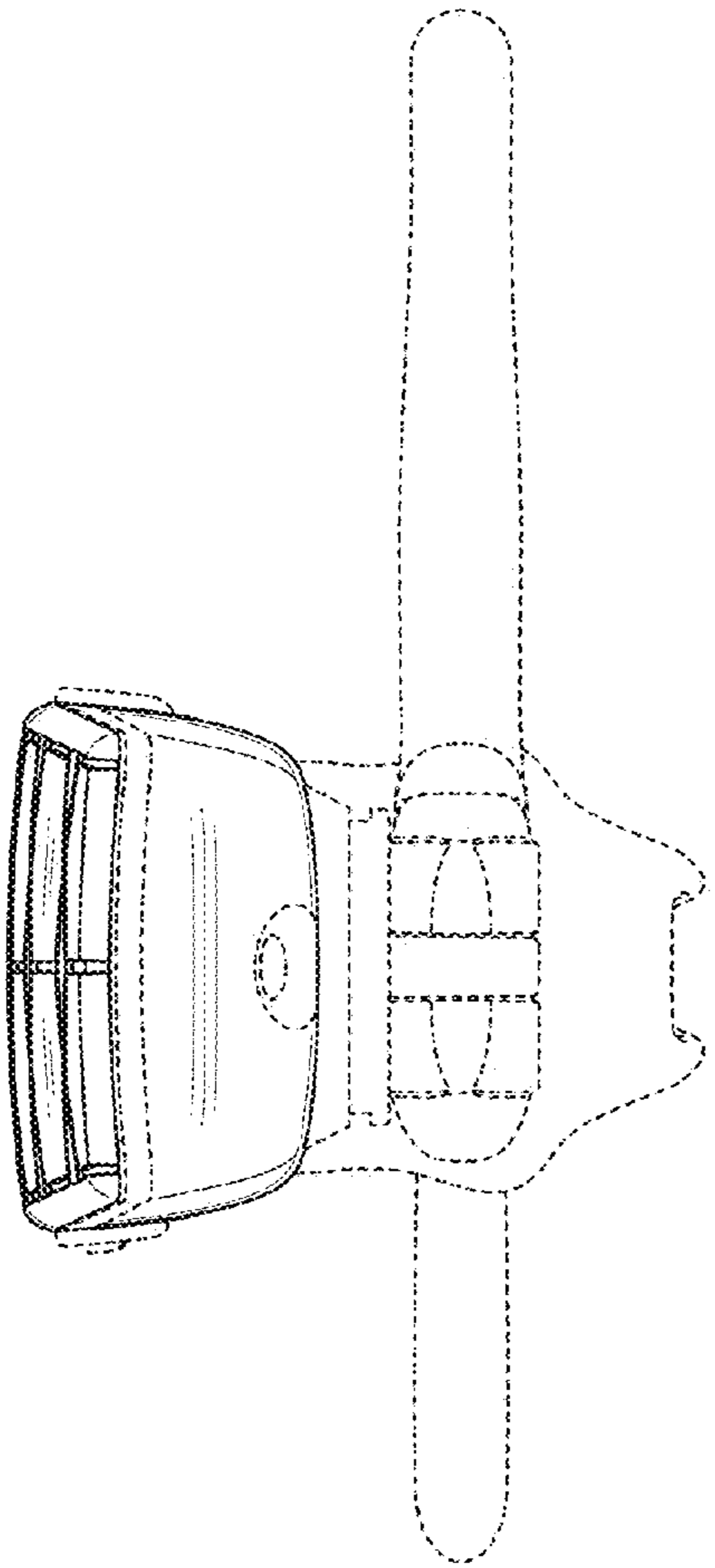

FIG. 5

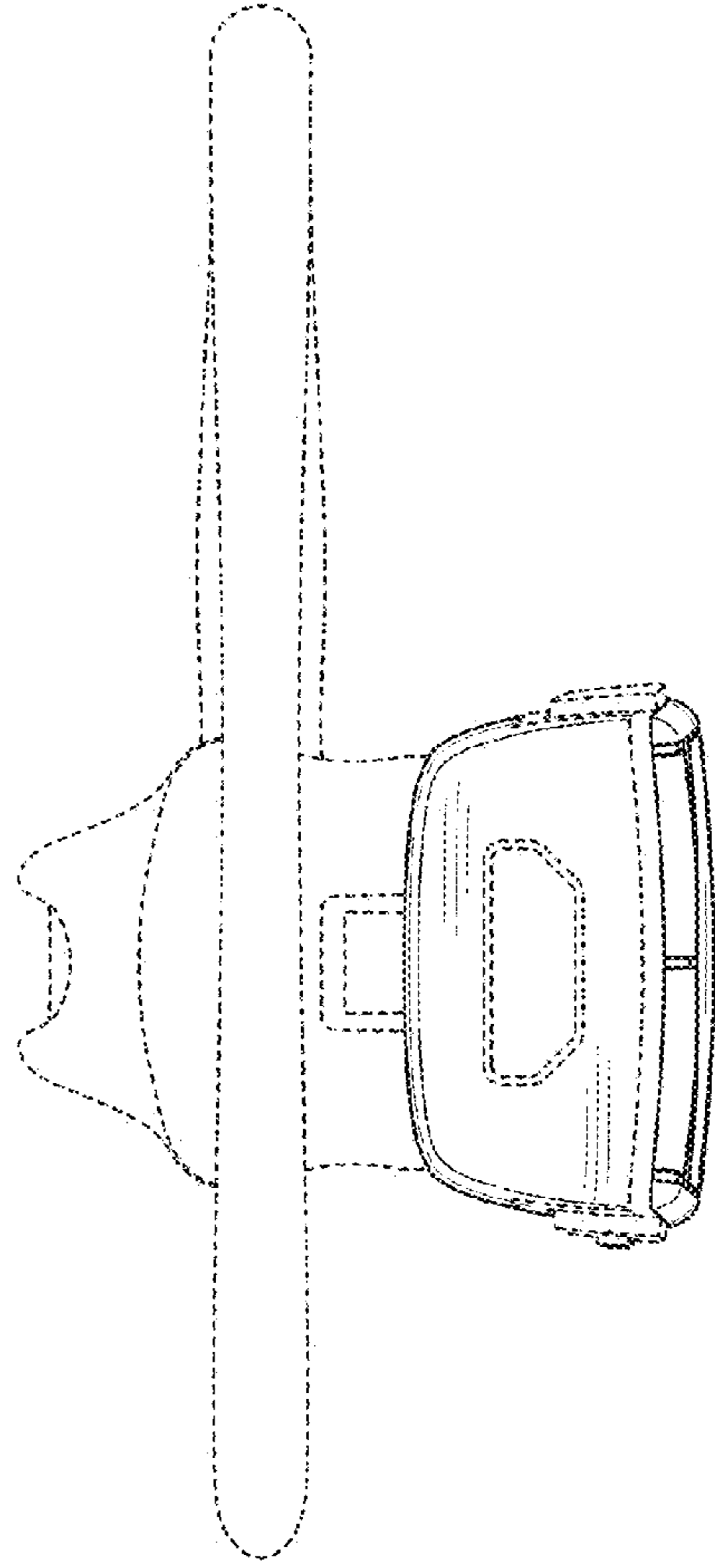

FIG. 6

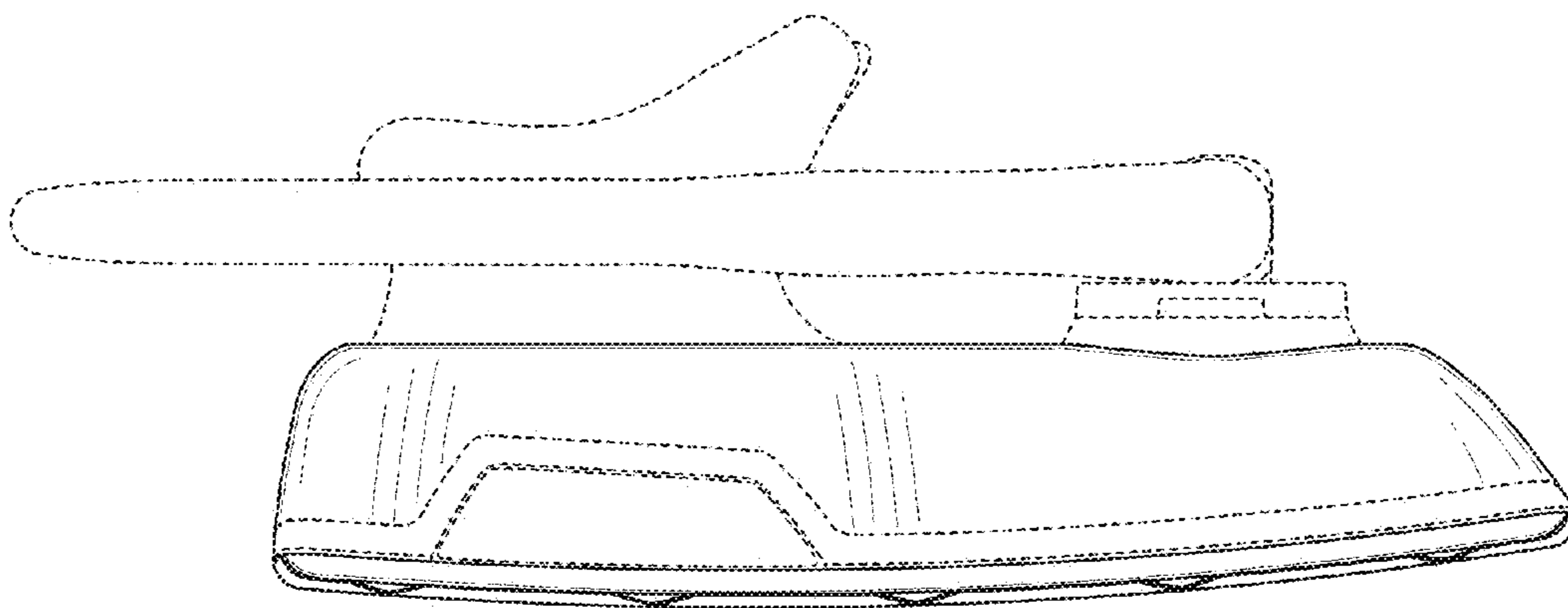

FIG. 7

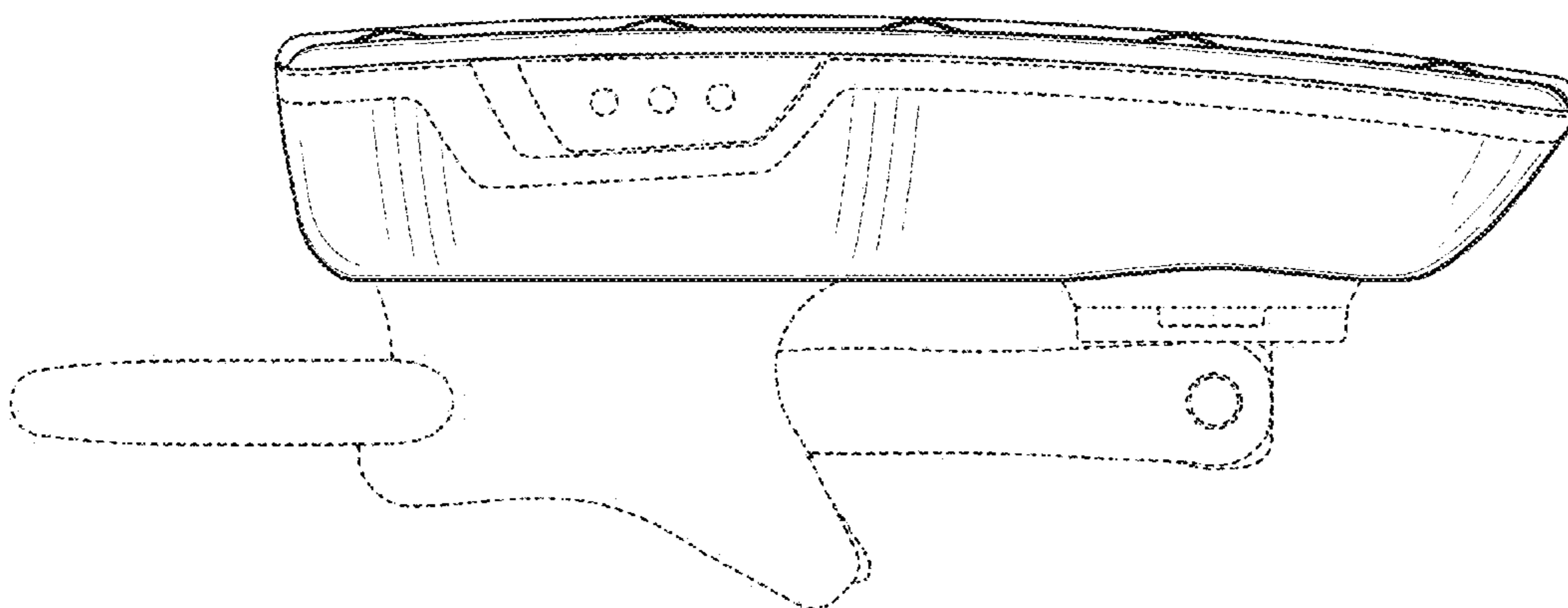

FIG. 8