

US00D754505S

(12) **United States Design Patent**
deBretton Gordon

(10) **Patent No.:** **US D754,505 S**
(45) **Date of Patent:** **** Apr. 26, 2016**

- (54) **SCISSORS IN STAND**
- (71) Applicant: **Robert Welch Designs Ltd.**, Chipping
Campden, Gloucestershire (GB)
- (72) Inventor: **Iain Paul deBretton Gordon**,
Shipston-on-Stour (GB)
- (73) Assignee: **Robert Welch Designs, LLC**, Chipping
Campden, Gloucestershire (GB)
- (**) Term: **14 Years**
- (21) Appl. No.: **29/508,804**
- (22) Filed: **Nov. 11, 2014**

D436,998 S *	1/2001	Brouwer	D19/77
D455,784 S *	4/2002	FitzGerald	D19/65
D483,635 S *	12/2003	Silver	D8/57
D584,588 S *	1/2009	Pearson	D8/57
D614,467 S *	4/2010	Wyant	D8/57
D617,167 S *	6/2010	Trotter	D8/57
D623,494 S *	9/2010	Tsai	D8/57
D623,495 S *	9/2010	Chuang	D8/57
D648,996 S *	11/2011	Hanakawa	D8/57
D652,694 S *	1/2012	de Bretton Gordon	D7/679
D673,013 S *	12/2012	Kent	D7/672
D678,008 S *	3/2013	May	D7/679
D680,836 S *	4/2013	Bhasin	D8/57
D715,614 S *	10/2014	Teraguchi	D8/57
D716,123 S *	10/2014	Teraguchi	D8/57
2007/0101582 A1 *	5/2007	Escobar	B25G 1/102 30/232
2014/0290071 A1 *	10/2014	Yoshida	B26B 13/06 30/254

(30) **Foreign Application Priority Data**

- May 19, 2014 (EM) 001411946-0001
- (51) **LOC (10) Cl.** **08-07**
- (52) **U.S. Cl.**
USPC **D8/57; D19/75**
- (58) **Field of Classification Search**
USPC D8/51-58; D7/693, 687, 674; D19/95,
D19/75, 77
CPC A01G 3/02; A01G 3/065; A61B 17/3201;
B26B 13/28; B26B 13/10
See application file for complete search history.

(56) **References Cited**

U.S. PATENT DOCUMENTS

D234,058 S *	1/1975	Stahel	D19/65
D295,493 S *	5/1988	Vigano'	D8/57
D305,976 S *	2/1990	Holterscheidt	D8/104
D398,502 S *	9/1998	Jacquet	D8/57
D413,240 S *	8/1999	Jacquet	D8/57

* cited by examiner

Primary Examiner — Deanna L Pratt

(74) *Attorney, Agent, or Firm* — MacMillan, Sobanski & Todd, LLC

(57) **CLAIM**

The ornamental design for a scissors in stand, as shown and described.

DESCRIPTION

FIG. 1 is a perspective view as seen from the upper right side of a scissors in stand showing my new design;
FIG. 2 is a front elevational view thereof;
FIG. 3 is a rear elevational view thereof;
FIG. 4 is a right side elevational view thereof;
FIG. 5 is a right side elevational view thereof;
FIG. 6 is a bottom view thereof; and,
FIG. 7 is a top view thereof.

1 Claim, 6 Drawing Sheets

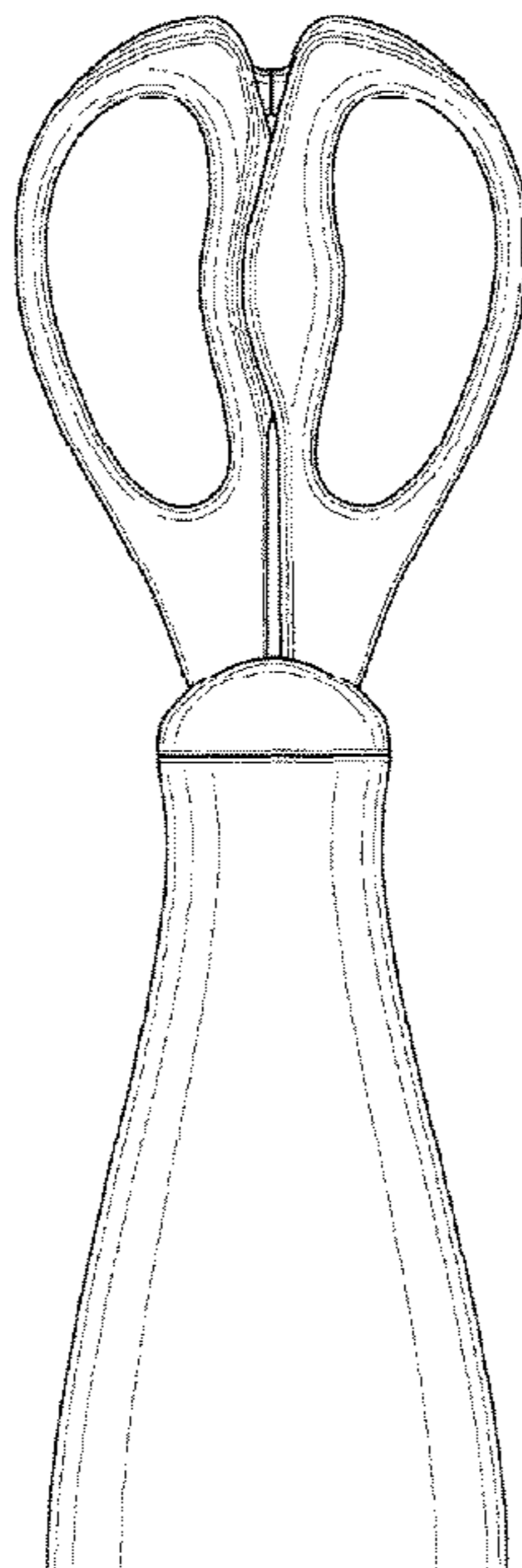

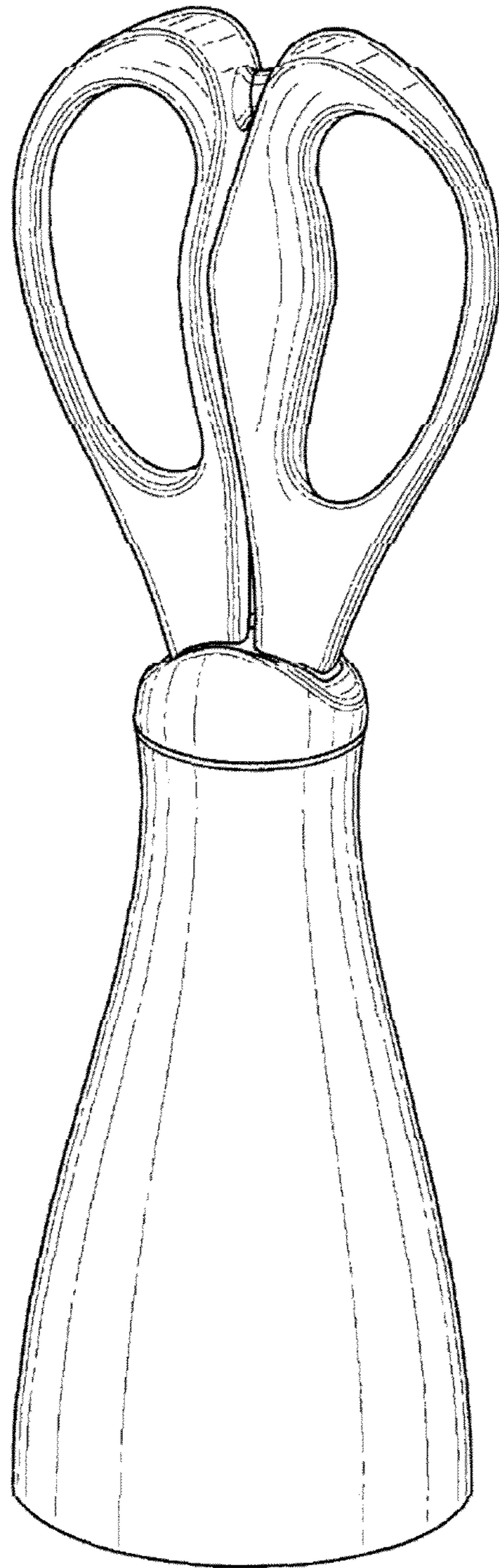

FIG. 1

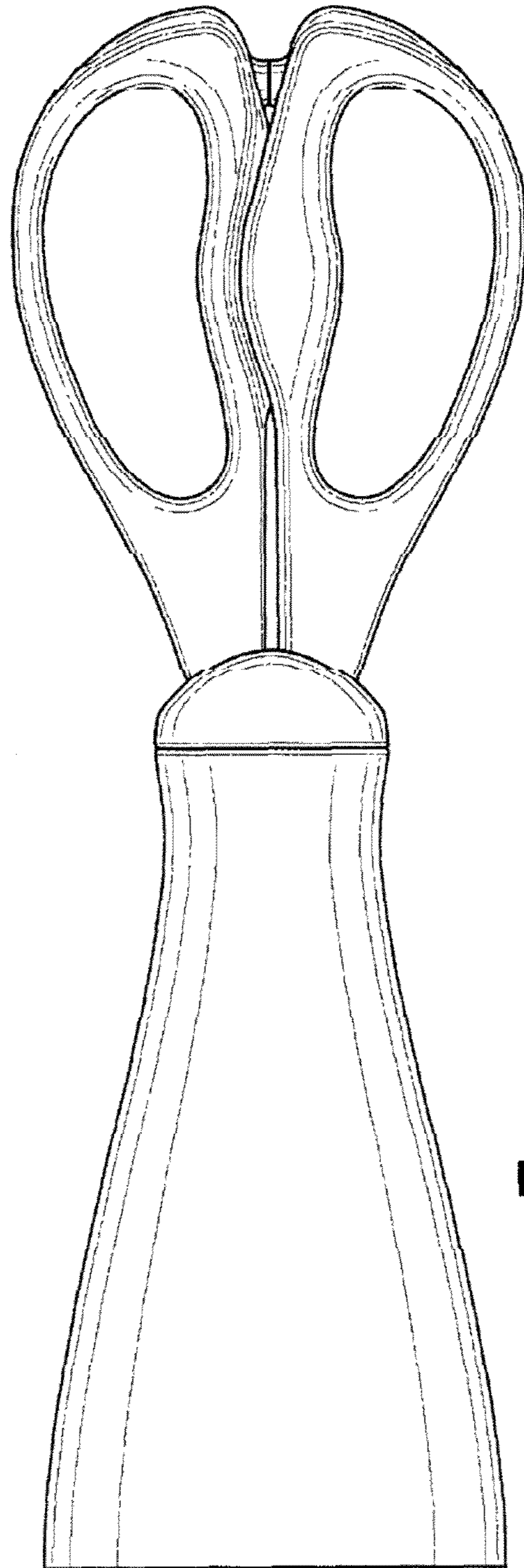

FIG. 2

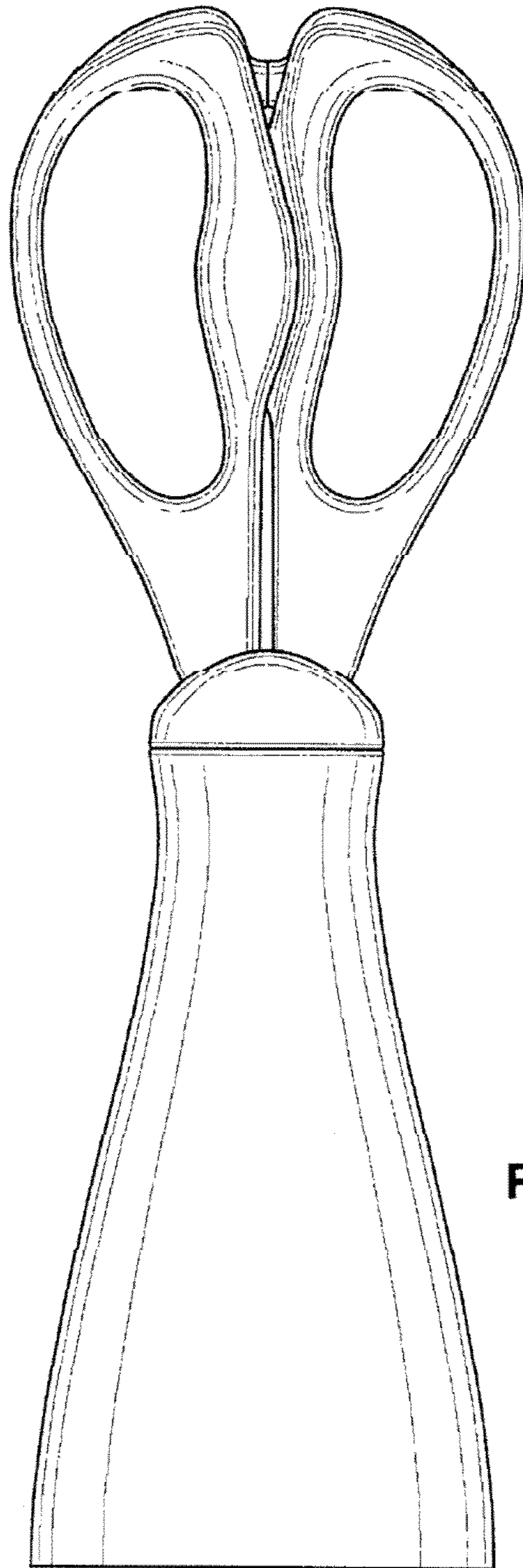

FIG. 3

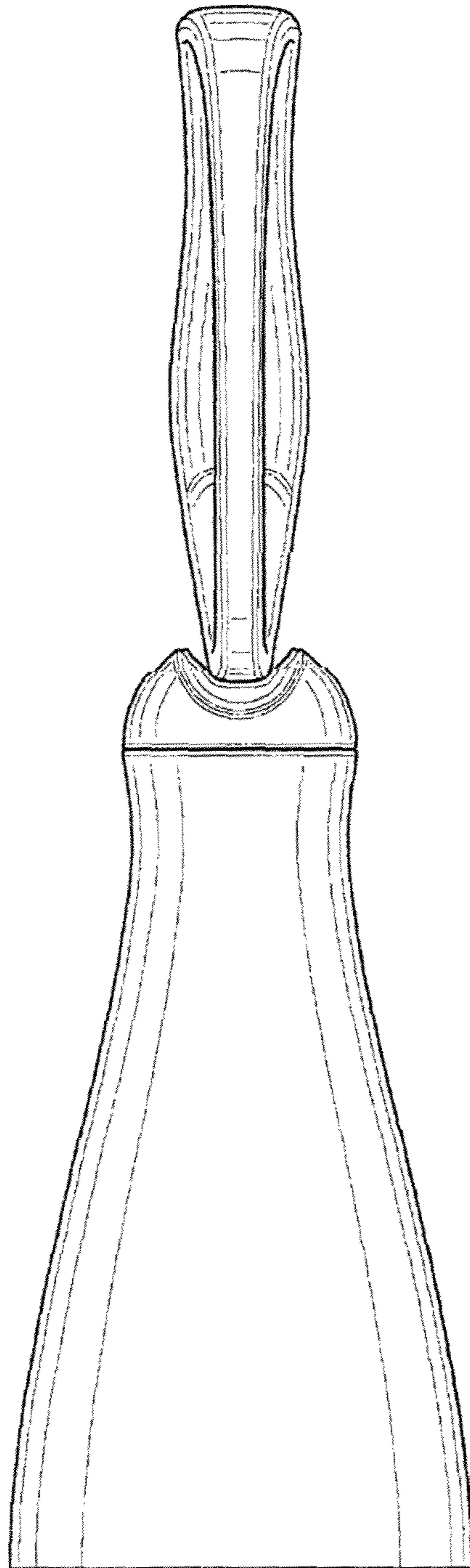

FIG. 4

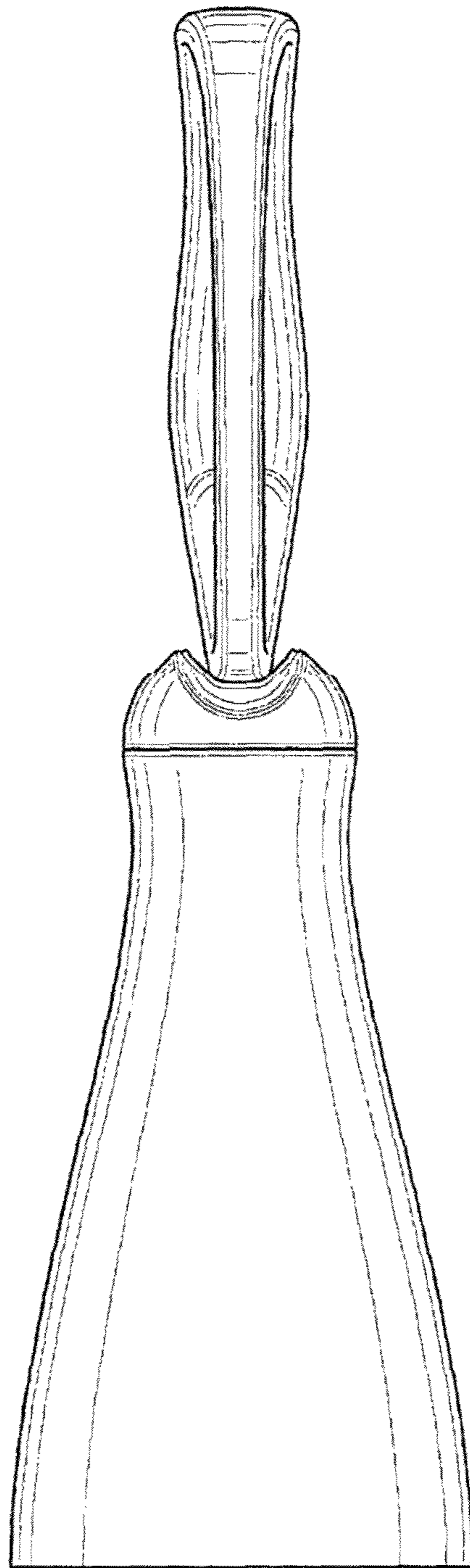

FIG. 5

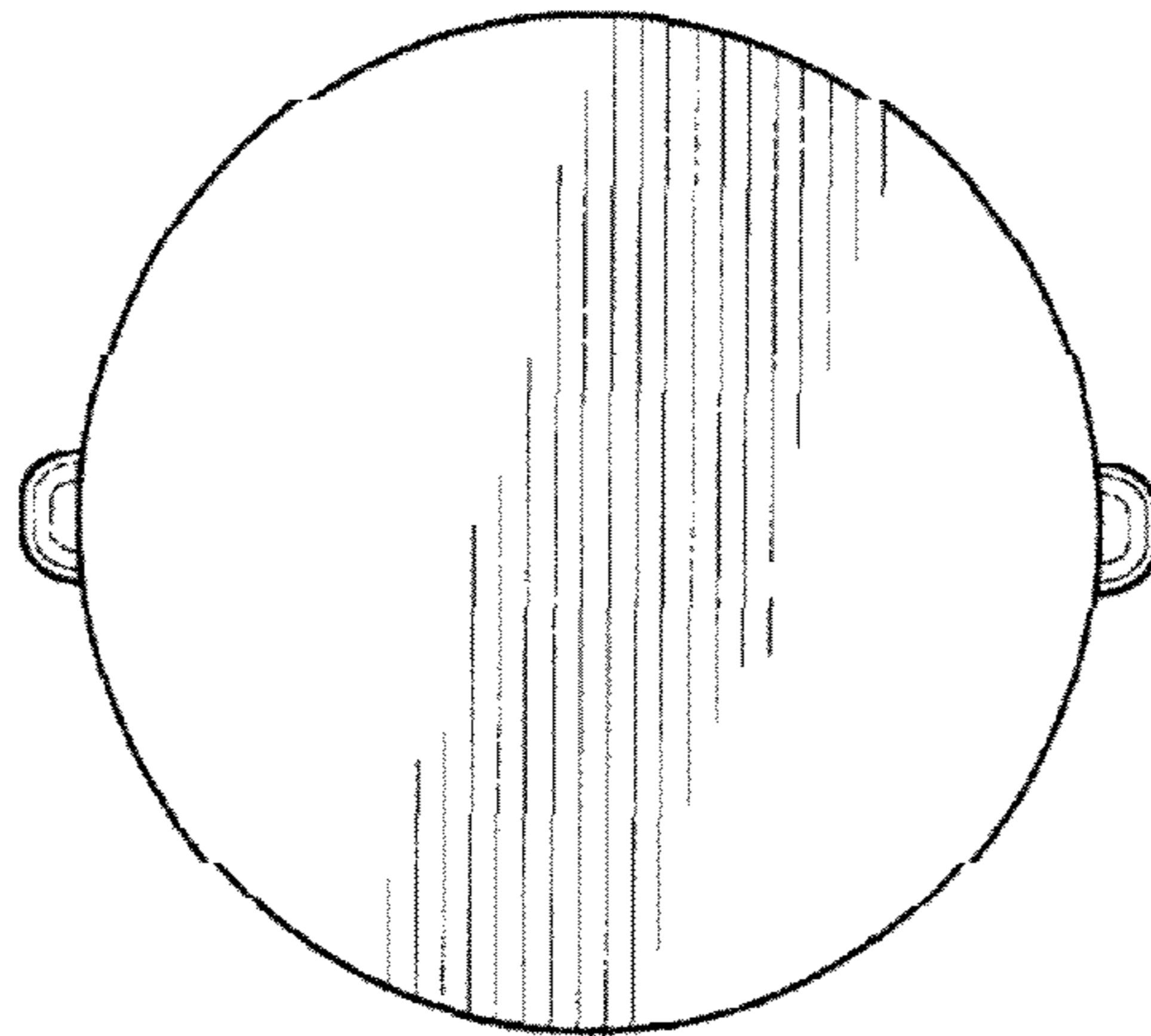

FIG. 6

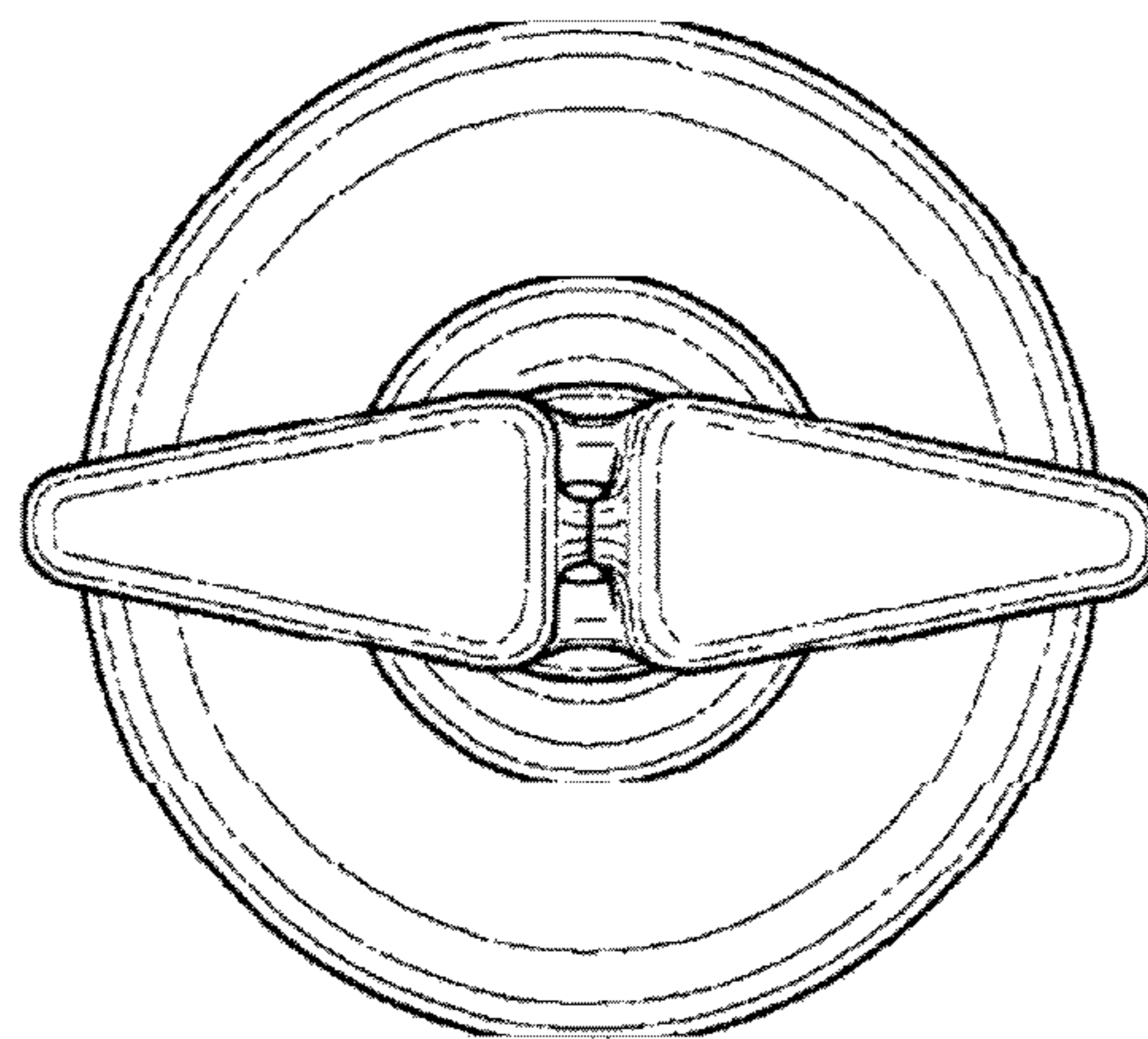

FIG. 7