



US00D754421S

(12) **United States Design Patent**  
**Caird**

(10) **Patent No.:** **US D754,421 S**

(45) **Date of Patent:** **\*\* \*Apr. 26, 2016**

(54) **BASEBALL HELMET**

(71) Applicant: **Clay Edward James Caird,**  
Christchurch (NZ)

(72) Inventor: **Clay Edward James Caird,**  
Christchurch (NZ)

(\*) Notice: This patent is subject to a terminal disclaimer.

(\*\*) Term: **14 Years**

(21) Appl. No.: **29/489,988**

(22) Filed: **May 5, 2014**

(30) **Foreign Application Priority Data**

Jan. 17, 2014 (AU) ..... 10198/2014

(51) **LOC (10) Cl.** ..... **02-03**

(52) **U.S. Cl.**  
USPC ..... **D2/870; D2/872**

(58) **Field of Classification Search**  
USPC ..... D2/865, 868, 869, 870, 872, 873, 876,  
D2/878, 879, 882, 891, 892; 2/171,  
2/171.03, 200.1, 200.3, 411, 205, 209.3,  
2/209.11, 171.1, 909, 410, 425;  
D29/102, 104, 105, 106, 108, 109, 112  
CPC ..... A42B 1/004; A42B 1/08; A42B 1/208;  
A42B 3/00; A63B 71/10

See application file for complete search history.

(56) **References Cited**

**U.S. PATENT DOCUMENTS**

- 79,420 A \* 6/1868 Waterman ..... A42B 1/208  
2/195.1
- 80,352 A \* 7/1868 Imbach ..... A42B 1/02  
2/195.1
- 1,598,379 A \* 8/1926 Kerr ..... A42B 1/04  
2/171.02
- 1,631,210 A \* 6/1927 Johnson ..... A42B 1/208  
2/12
- 2,594,906 A \* 4/1952 Gardner ..... A42B 1/208  
2/171.01

- 2,682,668 A \* 7/1954 Hoeflich ..... A42B 1/208  
2/195.1
- 2,740,567 A \* 4/1956 Kaufman ..... A42B 1/002  
2/195.5
- D186,759 S \* 12/1959 Crick, Jr. .... D29/105
- 3,041,628 A \* 7/1962 Fish ..... A42B 1/208  
2/195.2
- 3,042,927 A \* 7/1962 Mauro ..... A42B 3/324  
2/418
- D196,166 S \* 9/1963 Ellis ..... D2/876
- 3,212,214 A \* 10/1965 Patterson ..... A63H 33/16  
40/539
- D226,544 S \* 3/1973 Veltri ..... D2/876
- D352,378 S \* 11/1994 Wise ..... D2/869
- 5,380,001 A \* 1/1995 Socci ..... A42B 3/0433  
273/DIG. 17
- D360,518 S \* 7/1995 Posenauer ..... D2/872
- 5,428,842 A \* 7/1995 Wise ..... A42B 1/208  
2/195.1
- D407,889 S \* 4/1999 Lee ..... D2/882

(Continued)

**FOREIGN PATENT DOCUMENTS**

- EM 002400044-0001 \* 2/2014
- SE 78504-0001 \* 8/2005

*Primary Examiner* — Karen E. Eldridge Powers  
*Assistant Examiner* — Kimberly Barnes

(57) **CLAIM**

The ornamental design for a baseball helmet, as shown and described.

**DESCRIPTION**

FIG. 1 is a flat, unassembled view of a baseball helmet, according to my new design, the component pieces of which are shown separately for clarity of illustration. FIG. 2 is an assembled front perspective view thereof; FIG. 3 is an assembled front elevation view thereof; FIG. 4 is an assembled rear elevation view thereof; FIG. 5 is an assembled left side elevation view thereof; FIG. 6 is an assembled right side elevation view thereof; FIG. 7 is an assembled top plan view thereof; and, FIG. 8 is an assembled bottom plan view thereof. The broken lines in the drawings indicate fold lines and form part of the claimed design.

**1 Claim, 8 Drawing Sheets**

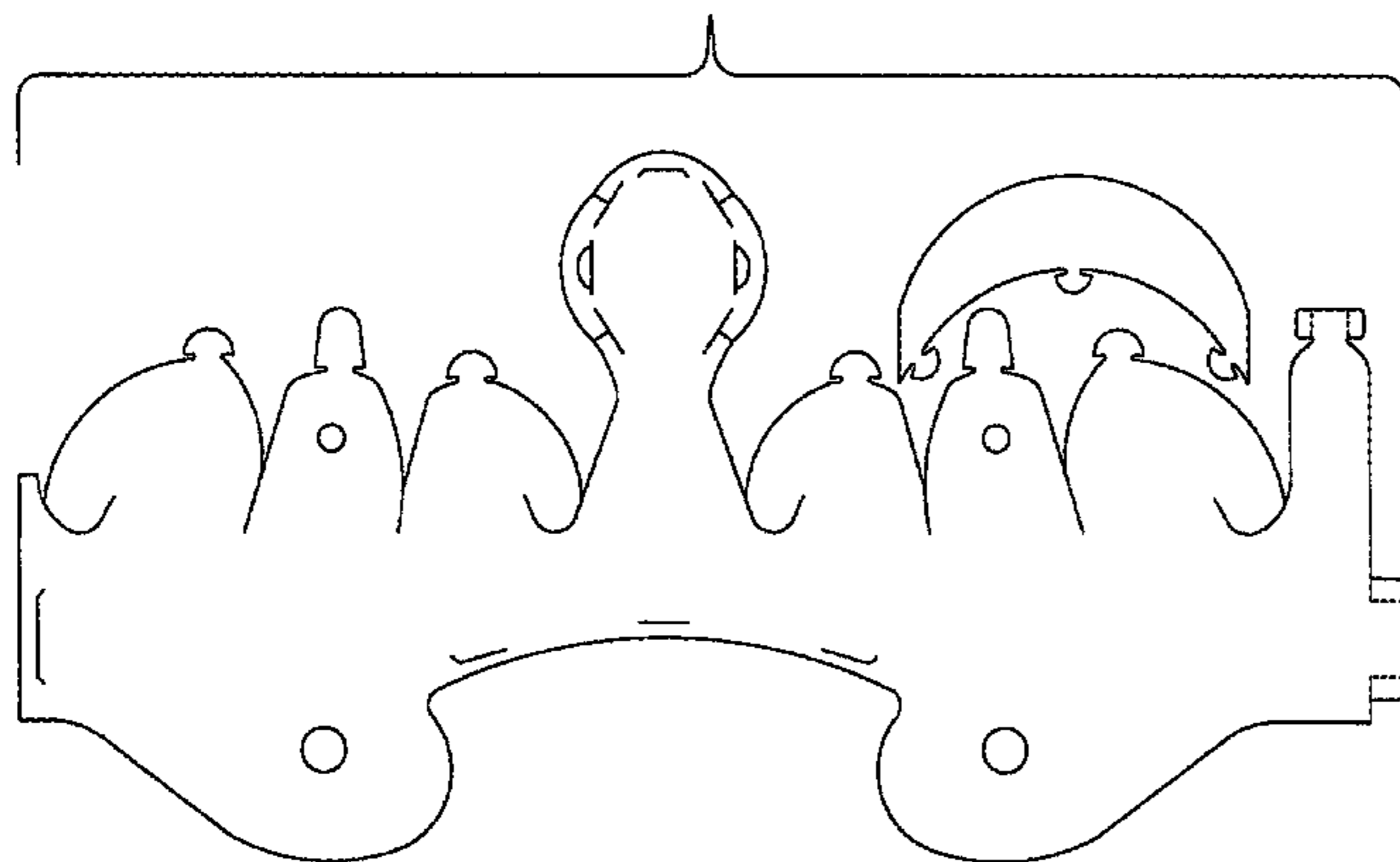

(56)

References Cited

U.S. PATENT DOCUMENTS

5,974,593	A *	11/1999	McNabb	.....	A42B 3/145	2/414
6,128,786	A *	10/2000	Maddux	.....	A42B 3/145	2/418
D480,761	S *	10/2003	Miska	.....	D20/29	
6,910,225	B2 *	6/2005	Kovalenko	.....	A42B 1/208	2/12
D514,281	S *	2/2006	Cho	.....	D2/875	
D519,801	S *	5/2006	Lee	.....	D29/106	
D634,517	S *	3/2011	Algar	.....	D2/882	
D665,132	S *	8/2012	Shook	.....	D29/105	
D682,512	S *	5/2013	Andrews	.....	D2/875	
8,635,713	B2 *	1/2014	Smith	.....	A42B 1/208	2/171.1
D716,503	S *	10/2014	Shook	.....	D29/105	
8,875,316	B2 *	11/2014	Smith	.....	A42B 1/201	2/171.1
D735,448	S *	8/2015	Caird	.....	D2/870	
2004/0019953	A1 *	2/2004	Galimant	.....	A42B 1/201	2/171
2005/0086727	A1 *	4/2005	Shen	.....	A42B 1/08	2/411

\* cited by examiner

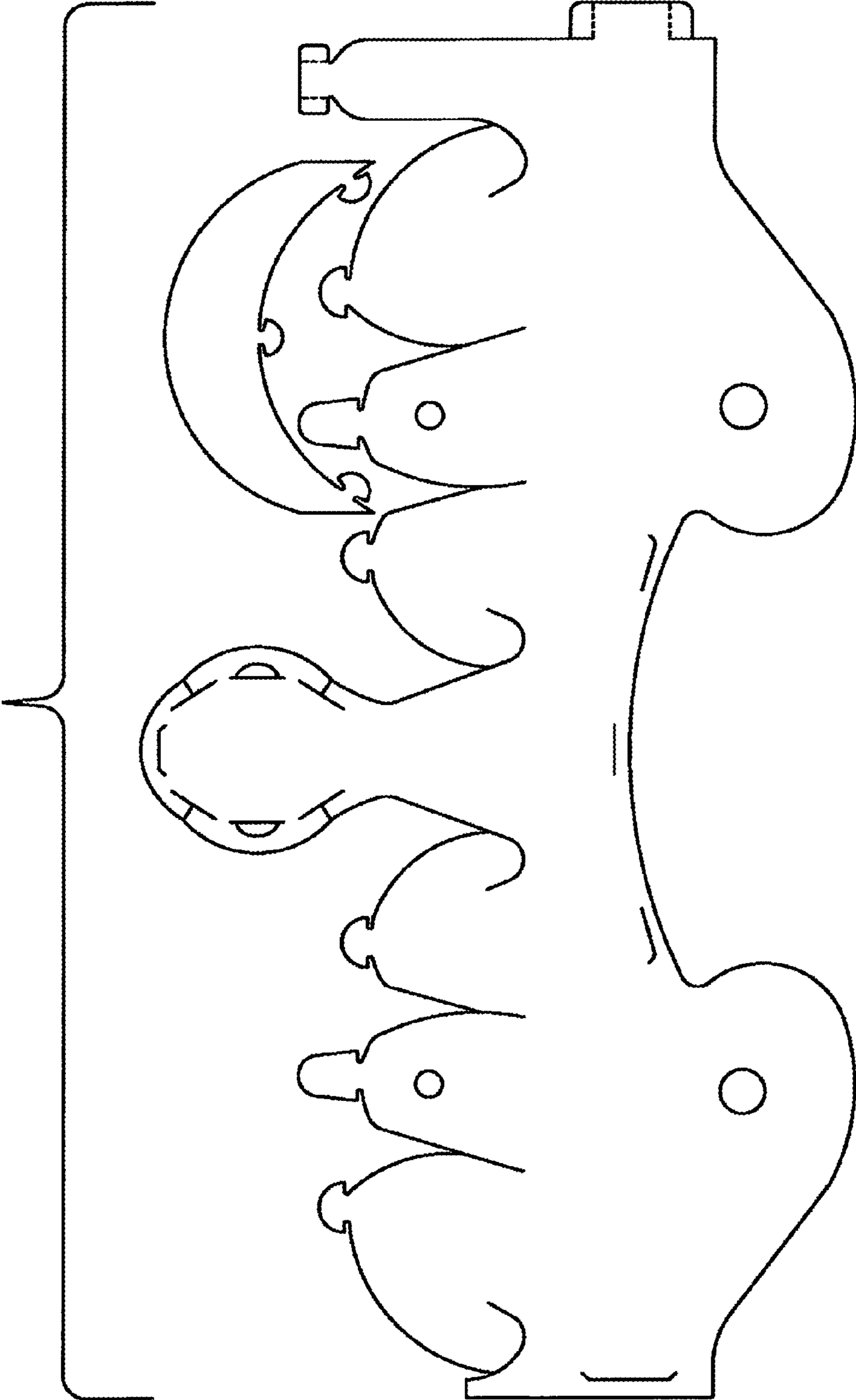

FIG. 1

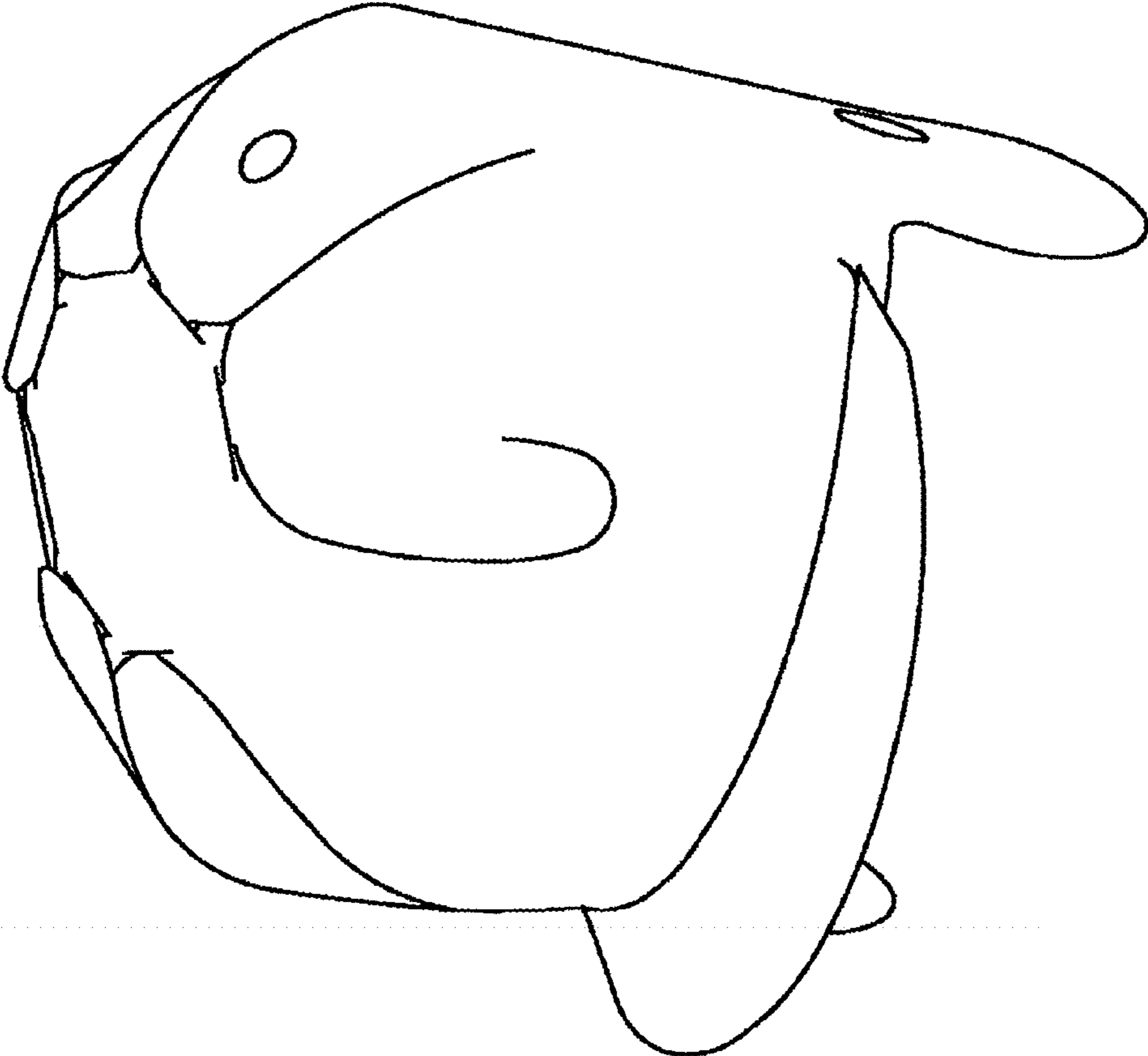

FIG. 2

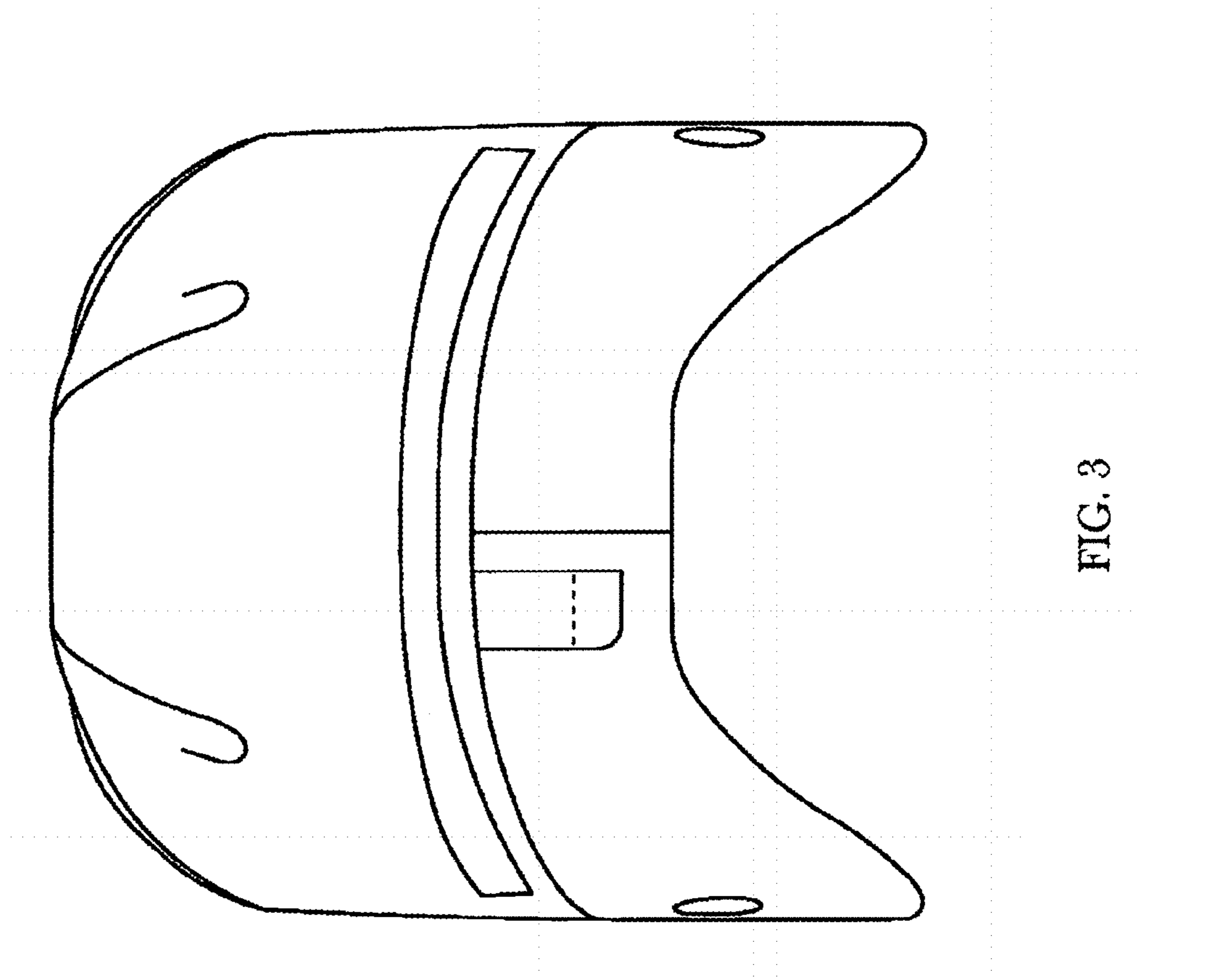

FIG. 3

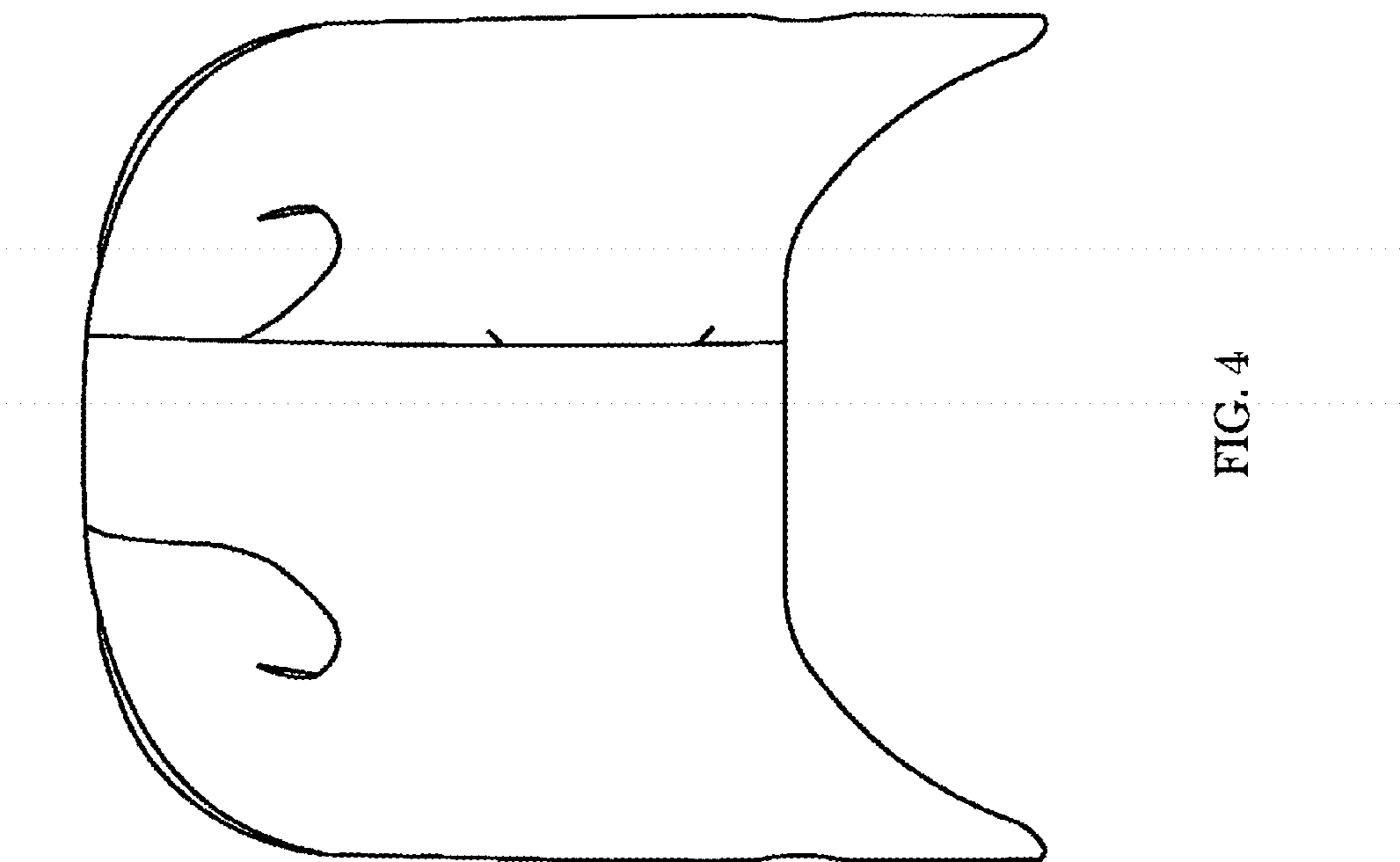

FIG. 4

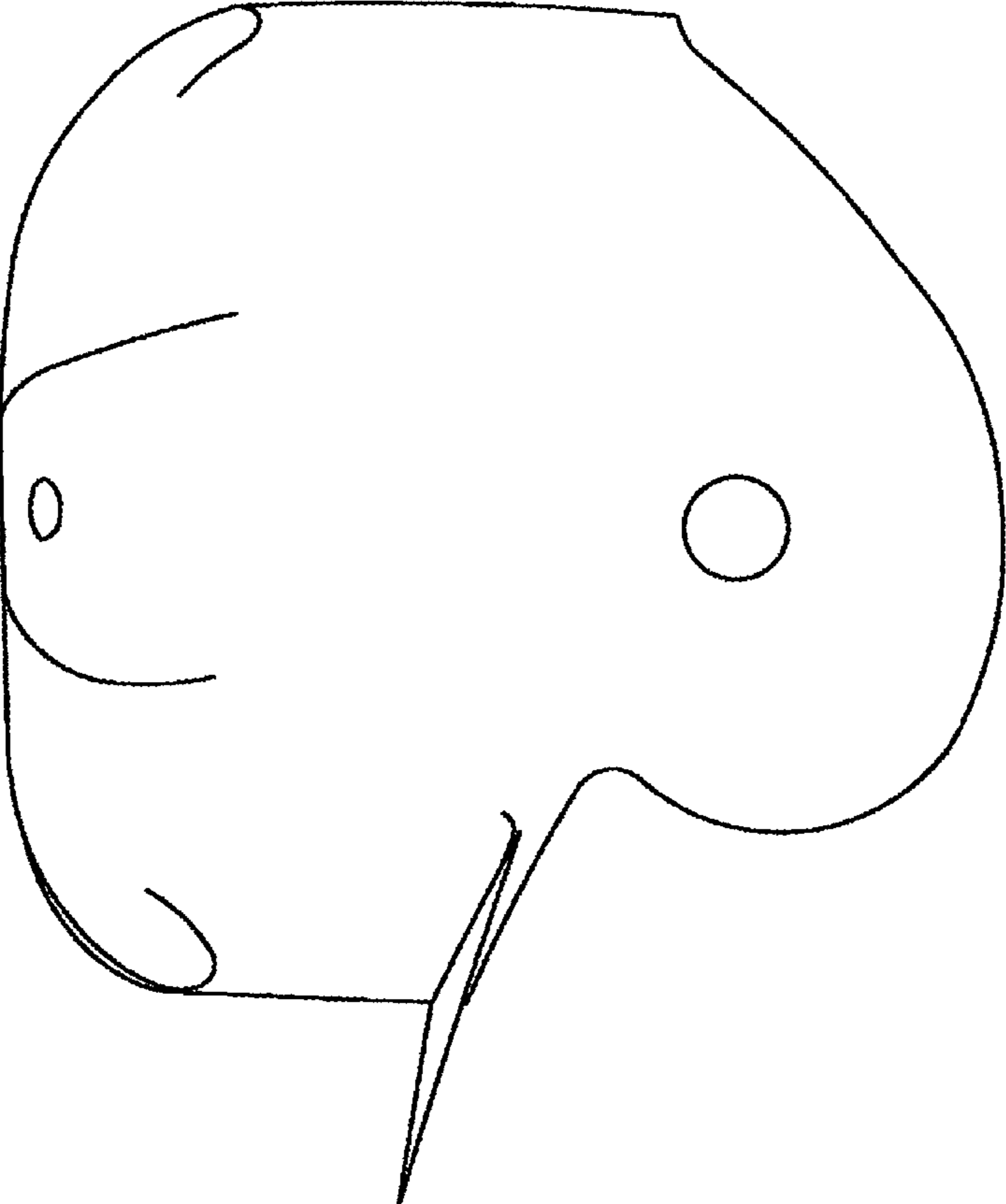

FIG. 5

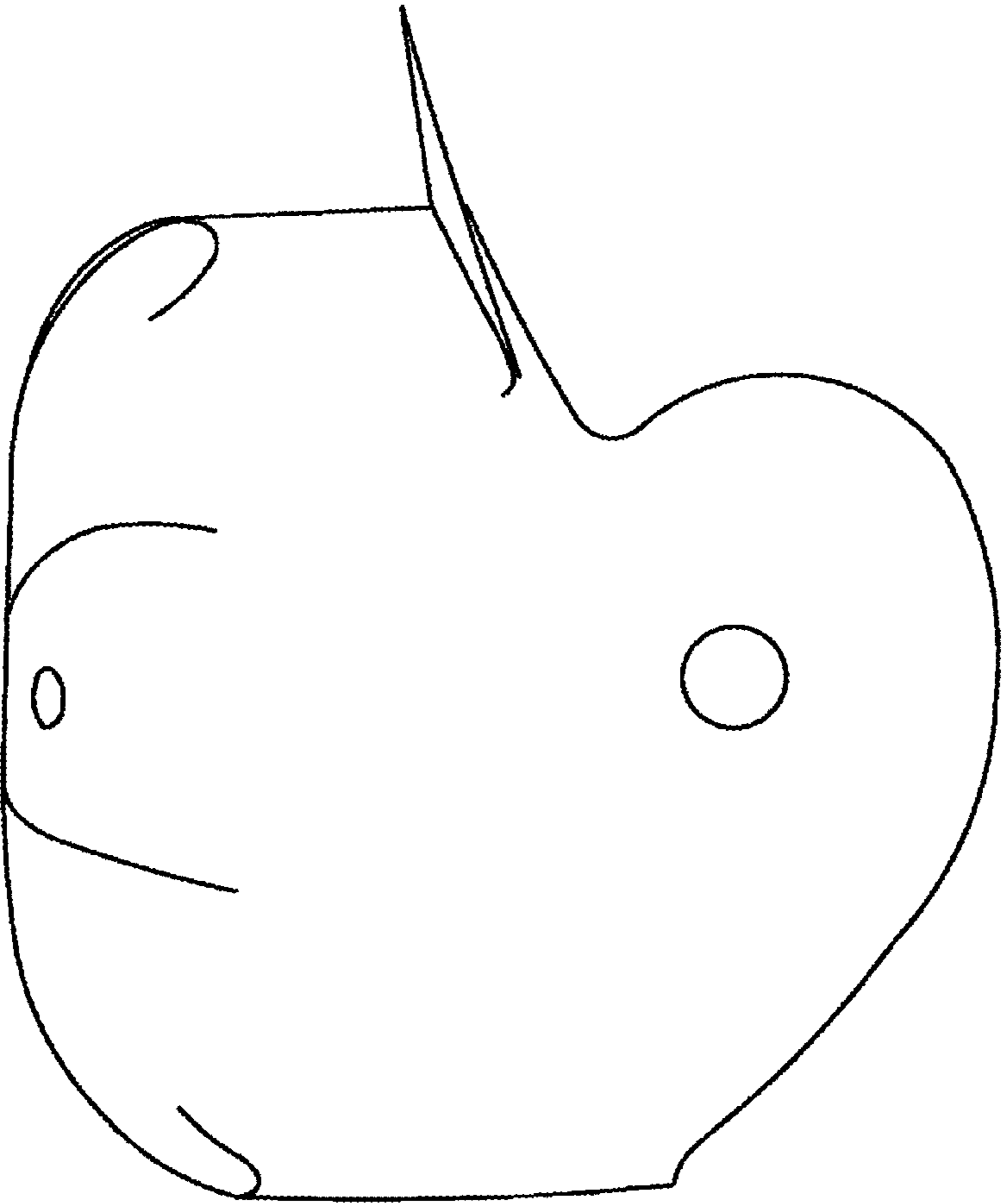

FIG. 6



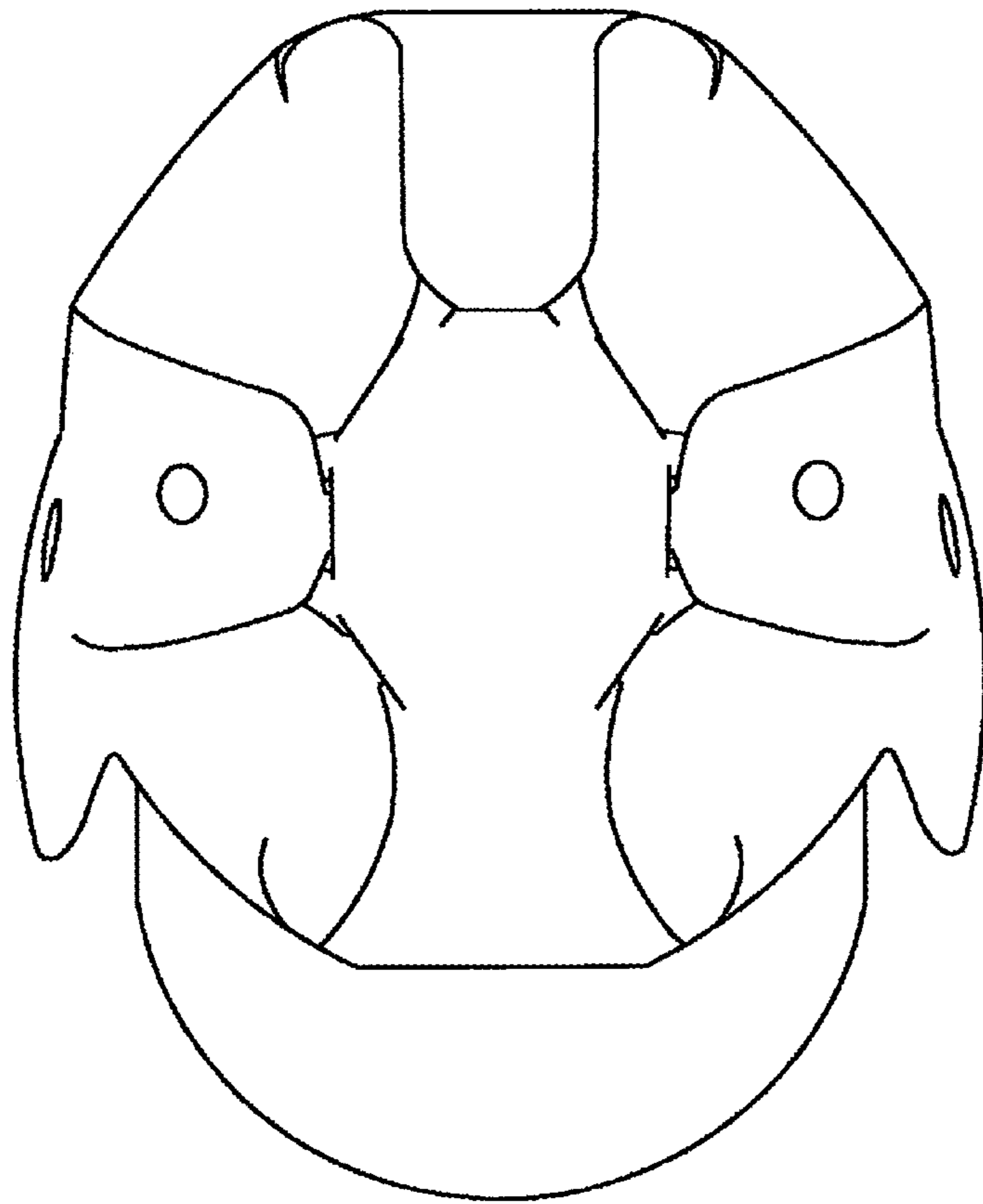

FIG. 7

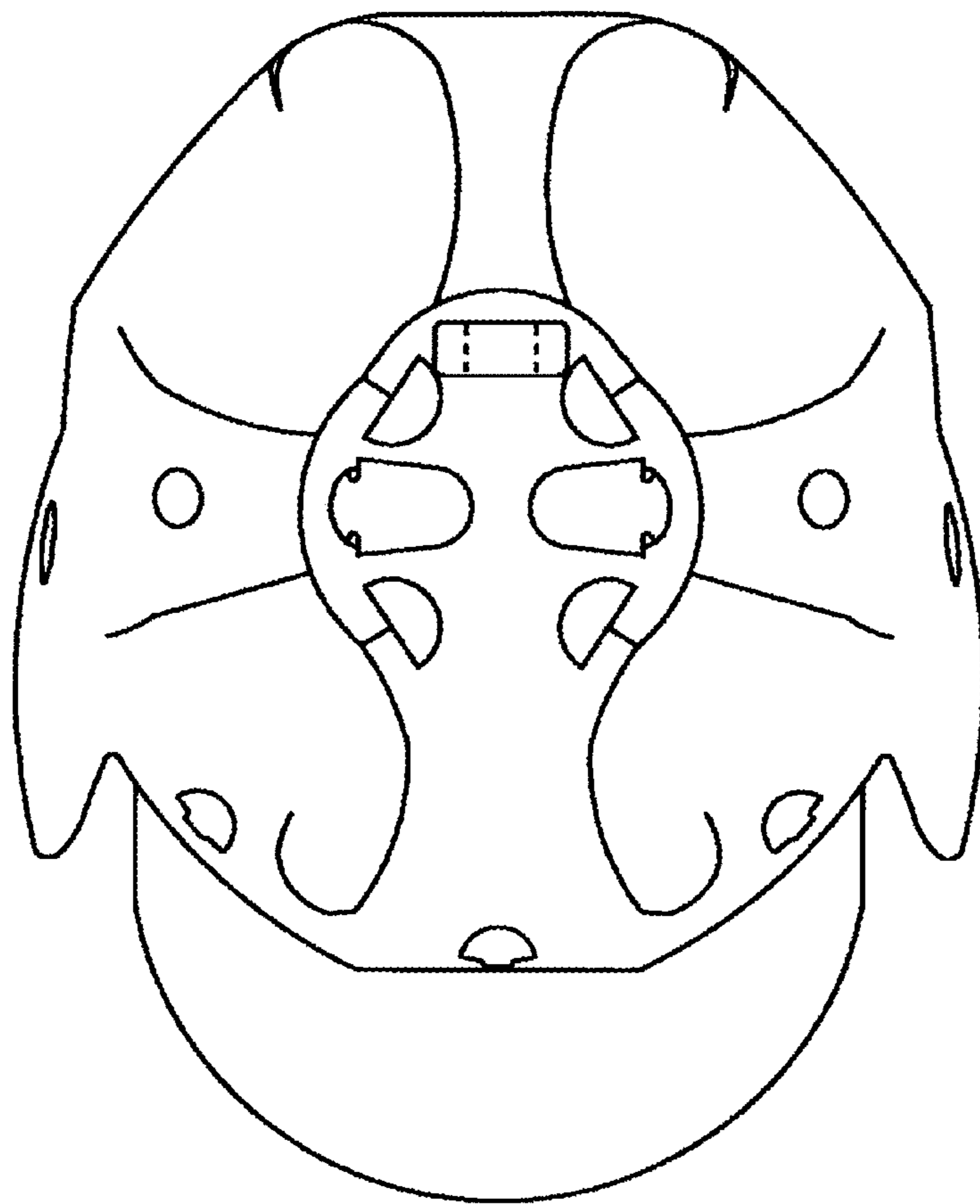

FIG. 8