



US00D754310S

(12) **United States Design Patent**  
**Norman et al.**

(10) **Patent No.:** **US D754,310 S**  
(45) **Date of Patent:** **\*\* Apr. 19, 2016**

(54) **AIR PURIFIER**

(71) Applicant: **The Procter & Gamble Company,**  
Cincinnati, OH (US)

(72) Inventors: **Joshua James Norman,** Cincinnati, OH  
(US); **Paul Edward Backett,** Portland,  
OR (US); **Emily Nicole Bayer,** Cleves,  
OH (US)

(73) Assignee: **The Procter & Gamble Company,**  
Cincinnati, OH (US)

(\*\*) Term: **14 Years**

(21) Appl. No.: **29/476,404**

(22) Filed: **Dec. 13, 2013**

(51) **LOC (10) Cl.** ..... **23-04**

(52) **U.S. Cl.**  
USPC ..... **D23/355**

(58) **Field of Classification Search**  
USPC ..... D23/314, 325, 329, 333, 334, 335, 342,  
D23/355, 356, 358, 359, 364, 386, 387, 388,  
D23/389, 390, 391; D7/396.2, 510, 511;  
D9/530, 535  
CPC ..... A61L 9/00; A61L 9/20; A61L 9/205;  
A61L 9/01; A61L 9/015; A61L 9/14; A61L  
9/16; F24F 1/00; F24F 3/16; F24F 3/166;  
F24F 3/1603; F24F 3/14; F24F 3/12; F24F  
7/00; B03C 1/00; B03C 3/32; B03C 3/15;  
B03C 3/155; B03C 3/16; B01D 23/00  
See application file for complete search history.

(56) **References Cited**

**U.S. PATENT DOCUMENTS**

D354,126 S \* 1/1995 Clawson et al. .... D23/358  
D359,654 S \* 6/1995 Westgerdes ..... D7/511  
D389,905 S \* 1/1998 Montague et al. .... D23/332  
D401,316 S \* 11/1998 Allen et al. .... D23/356

D438,606 S \* 3/2001 Jackson ..... D23/355  
D465,385 S \* 11/2002 Miller ..... D7/523  
D481,112 S \* 10/2003 Best et al. .... D23/356  
D482,435 S \* 11/2003 Kawakami et al. .... D23/359  
D505,294 S \* 5/2005 Gauss ..... D7/392.1  
D508,185 S \* 8/2005 Gauss ..... D7/392.1  
D519,380 S \* 4/2006 Leoncavallo et al. .... D9/530  
D536,431 S \* 2/2007 Campbell et al. .... D23/356  
D538,597 S \* 3/2007 Kim ..... D7/510  
D556,878 S \* 12/2007 Radtke et al. .... D23/328  
D558,869 S \* 1/2008 Bushee ..... D23/328  
D564,080 S \* 3/2008 Chen ..... D23/328  
D565,713 S \* 4/2008 Gao ..... D23/356  
D571,147 S \* 6/2008 Rohe ..... D7/392.1  
D583,035 S \* 12/2008 Gao ..... D23/356  
D592,905 S \* 5/2009 Pinelli et al. .... D7/396.2  
D596,459 S \* 7/2009 Ghiassi ..... D7/510  
D648,016 S \* 11/2011 Choi et al. .... D23/364  
D682,406 S \* 5/2013 Yeom ..... D23/364  
D683,581 S \* 6/2013 Archer ..... D7/392.1  
D685,606 S \* 7/2013 Keys et al. .... D7/392.1

(Continued)

*Primary Examiner* — Eric Goodman

*Assistant Examiner* — Bao-Yen Nguyen

(74) *Attorney, Agent, or Firm* — Abbey A. Lopez

(57) **CLAIM**

The ornamental design for an air purifier, as shown and described.

**DESCRIPTION**

FIG. 1 is a top perspective view of an air purifier;  
FIG. 2 is a bottom perspective view thereof;  
FIG. 3 is a rear view thereof;  
FIG. 4 is a front view thereof;  
FIG. 5 is a right side thereof;  
FIG. 6 is a left side thereof;  
FIG. 7 is a top view thereof; and,  
FIG. 8 is a bottom view thereof.  
The broken lines depict portions of the air purifier and form no part of the claimed design.

**1 Claim, 7 Drawing Sheets**

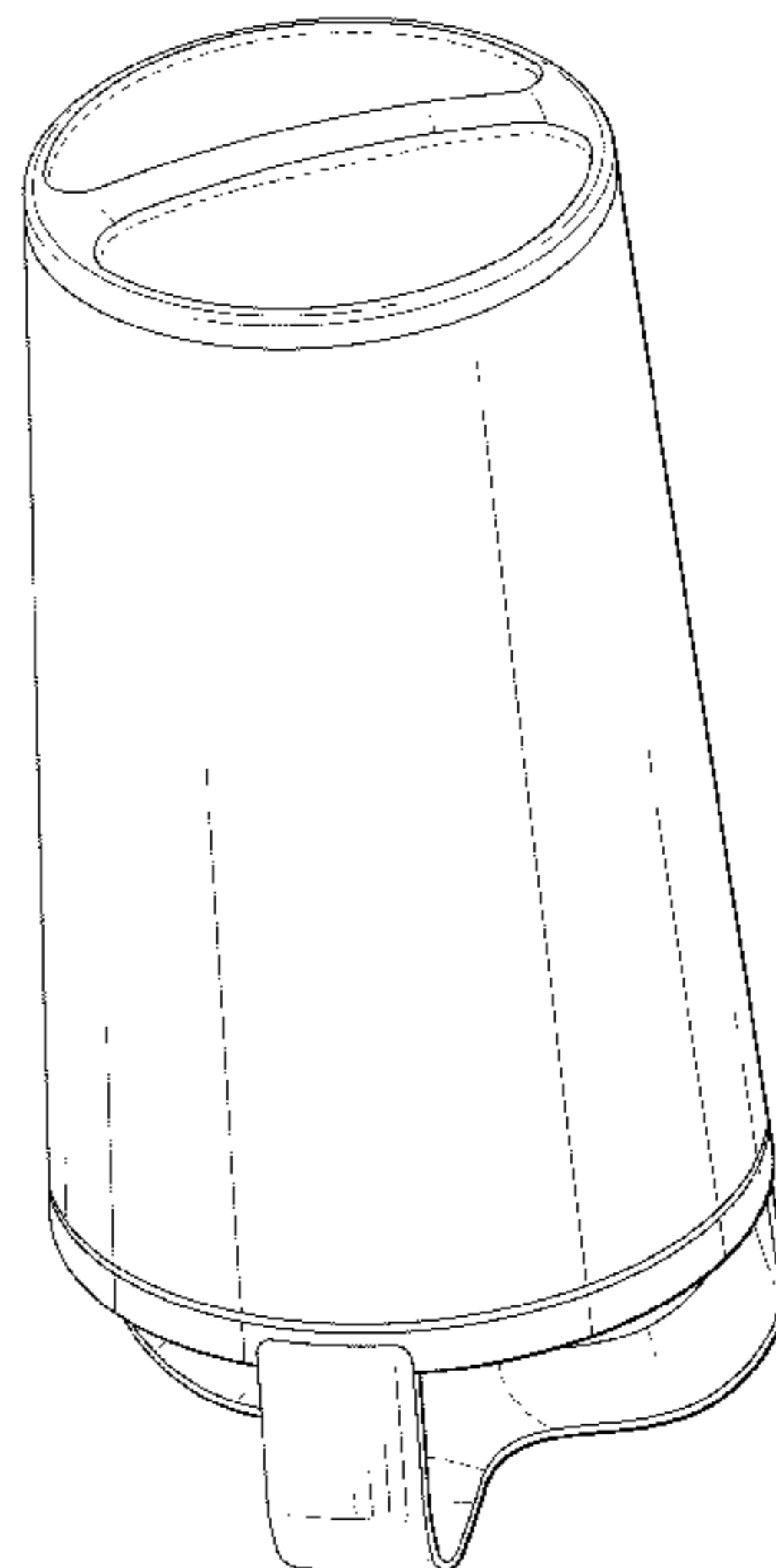

# US D754,310 S

Page 2

---

(56)

## References Cited

### U.S. PATENT DOCUMENTS

D704,320 S \* 5/2014 Li ..... D23/333  
D707,338 S \* 6/2014 Ediger et al. .... D23/356  
D714,154 S \* 9/2014 Keeler ..... D9/535

D718,572 S \* 12/2014 Sturgess ..... D7/396.2  
D724,384 S \* 3/2015 Donovan et al. .... D7/510  
D724,895 S \* 3/2015 Kawase et al. .... D7/510  
2009/0038480 A1 2/2009 Garman et al.  
2012/0180666 A1 7/2012 Lim et al.

\* cited by examiner

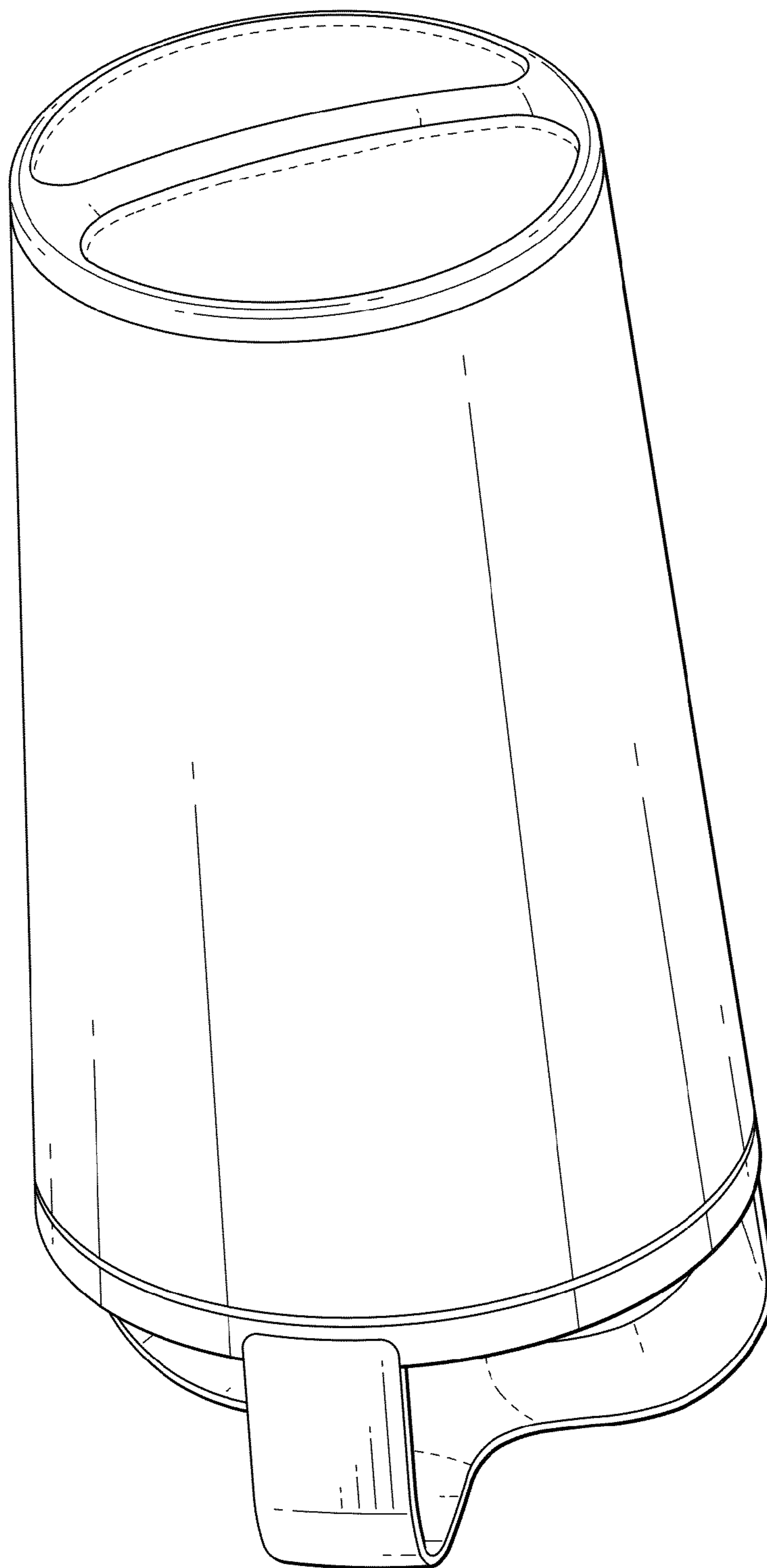

FIG. 1

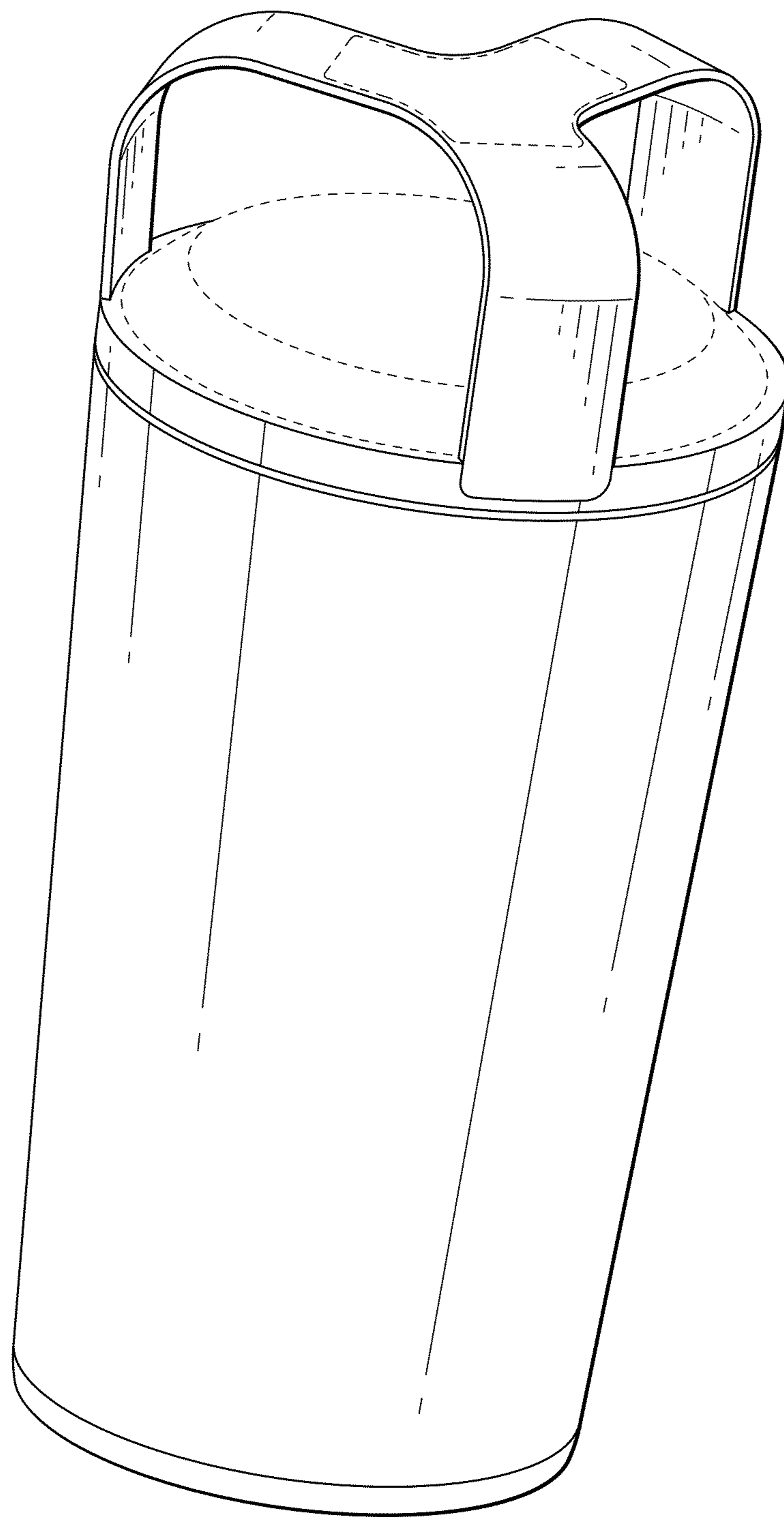

FIG. 2

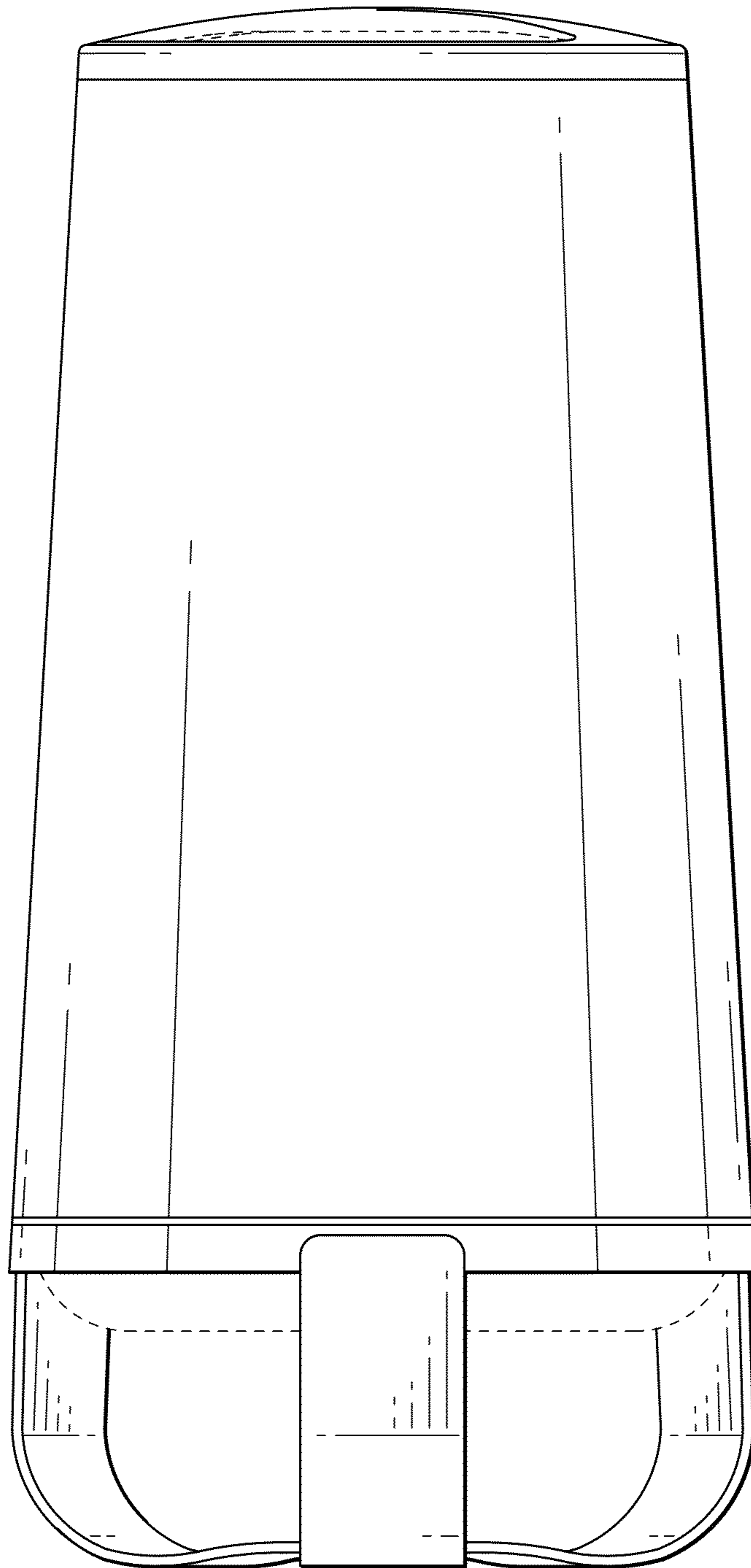

FIG. 3

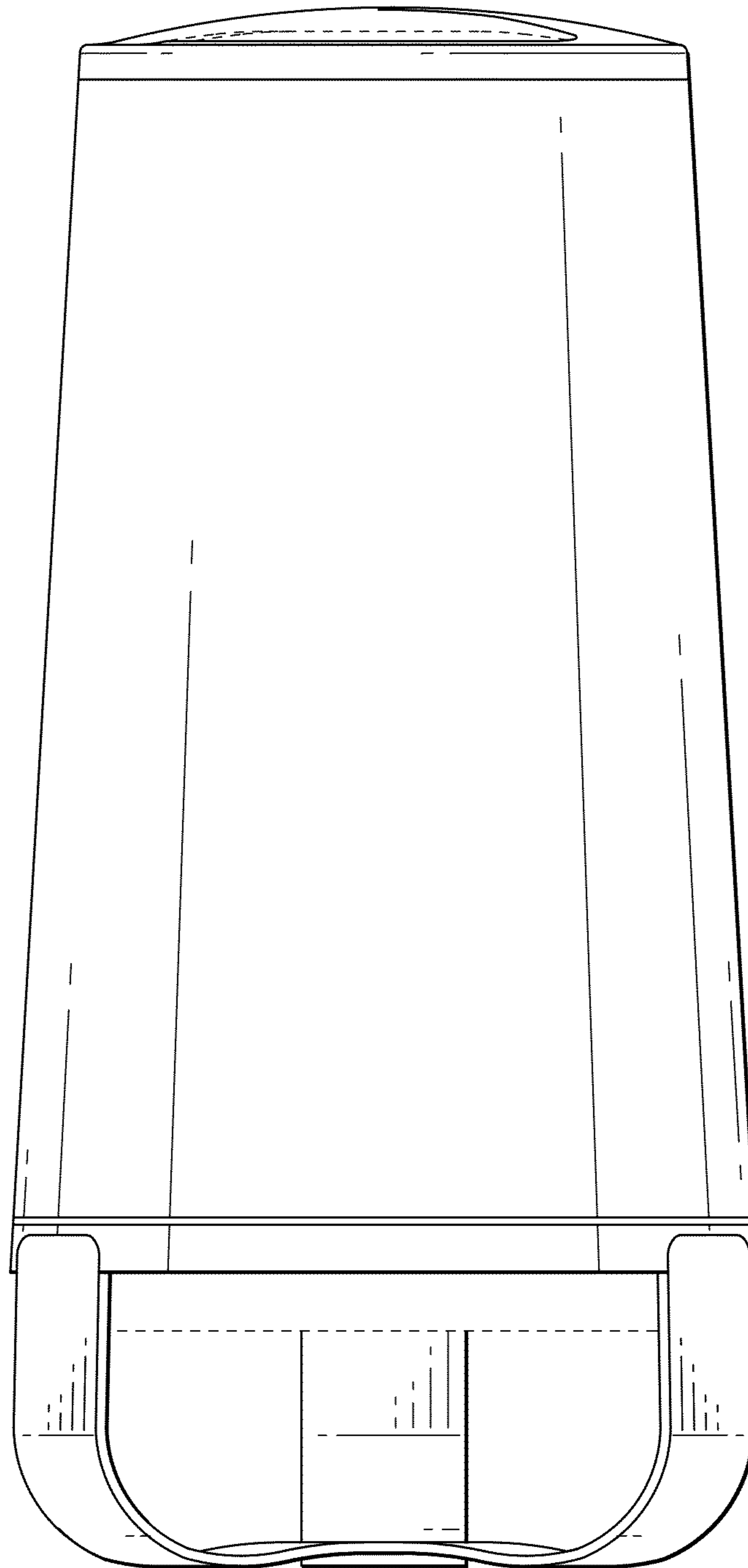

FIG. 4

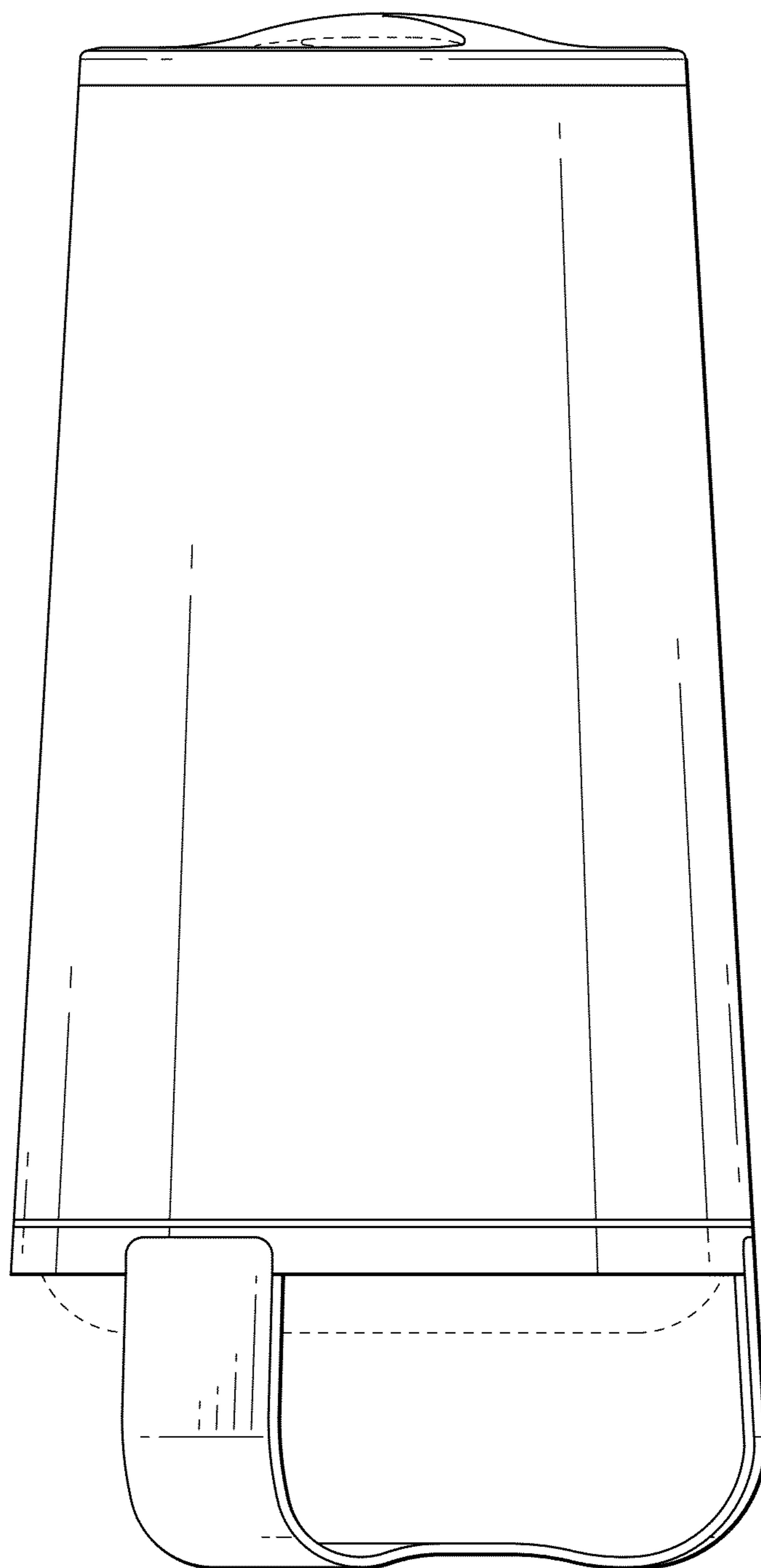

FIG. 5

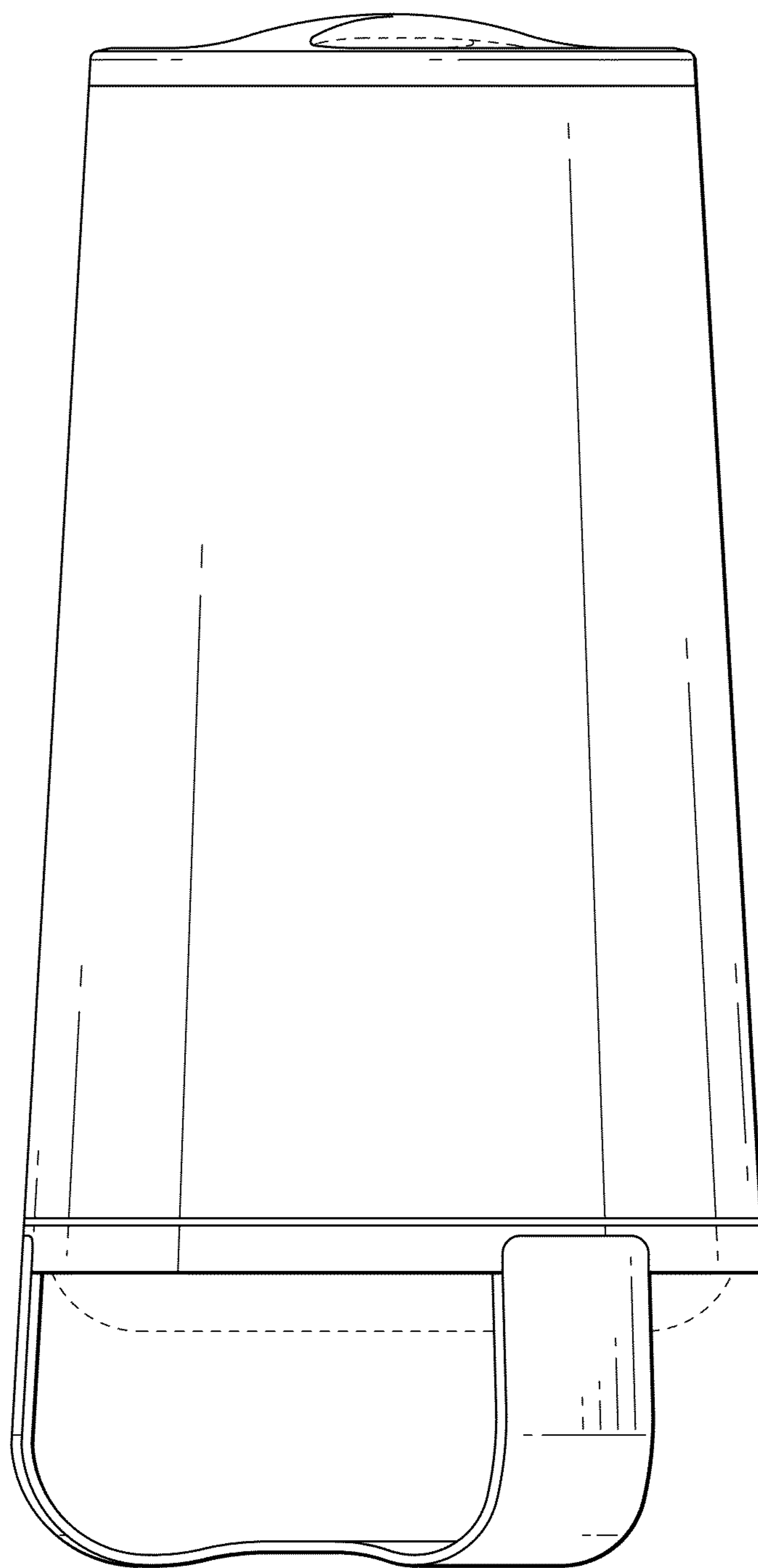

FIG. 6



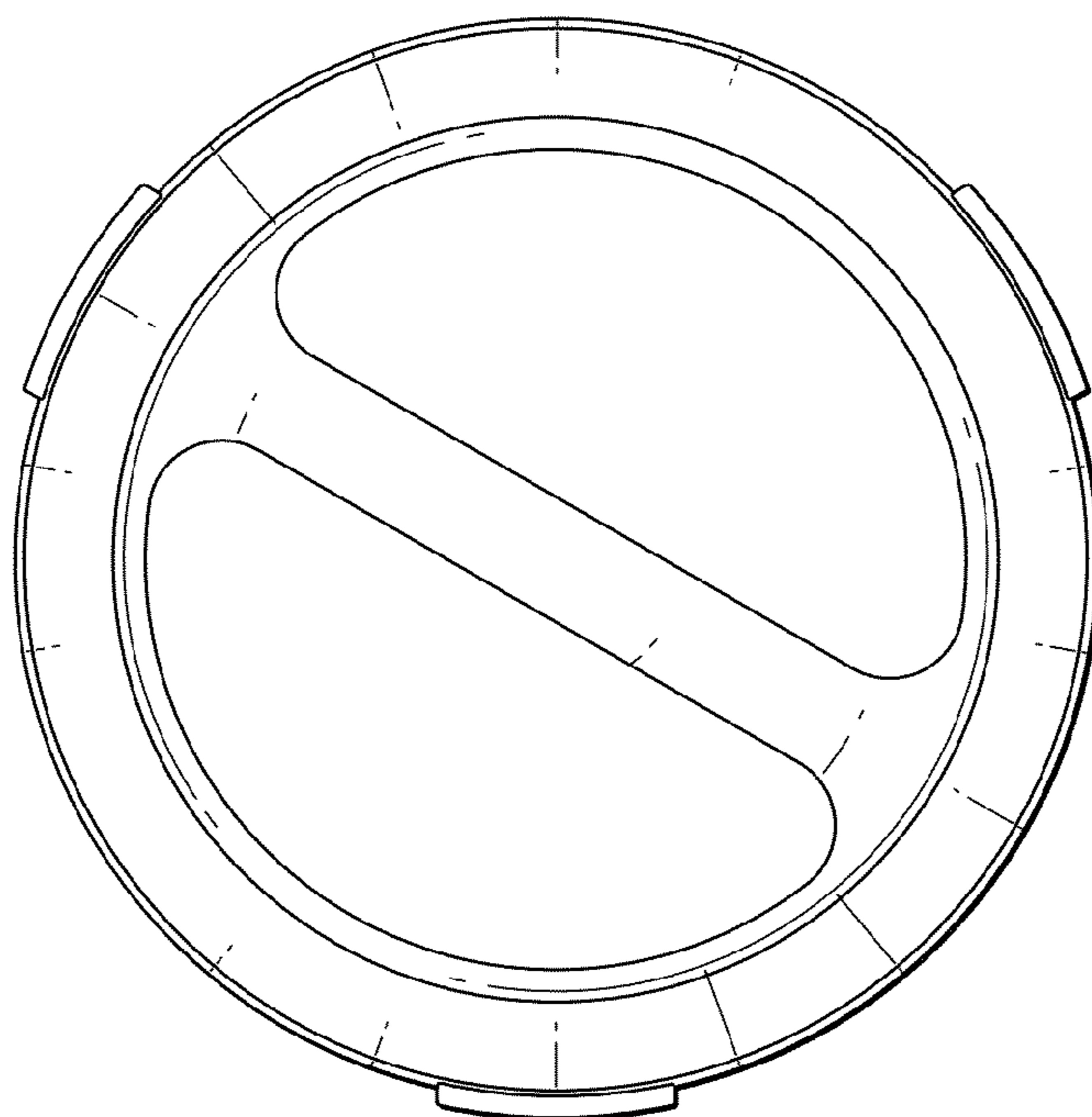

FIG. 7

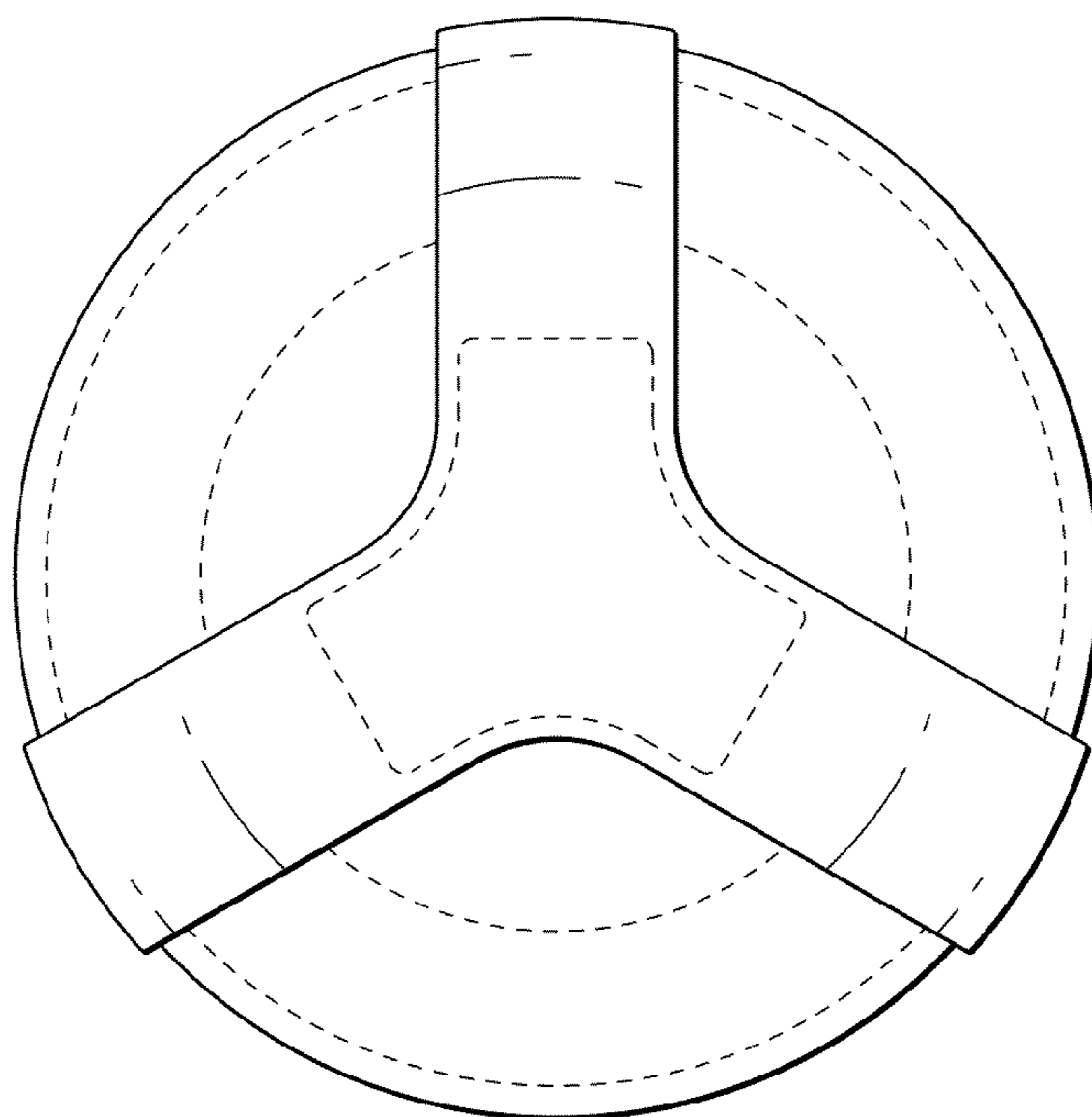

FIG. 8