



US00D754274S

(12) **United States Design Patent**
Geissele

(10) **Patent No.:** **US D754,274 S**

(45) **Date of Patent:** **** Apr. 19, 2016**

(54) **FIREARM RAIL**

(71) Applicant: **WHG Properties, LLC**, North Wales, PA (US)

(72) Inventor: **William H. Geissele**, North Wales, PA (US)

(73) Assignee: **WHG Properties, LLC**, North Wales, PA (US)

(**) Term: **14 Years**

(21) Appl. No.: **29/510,028**

(22) Filed: **Nov. 24, 2014**

(51) **LOC (10) Cl.** **22-01**

(52) **U.S. Cl.**
USPC **D22/108**

(58) **Field of Classification Search**
USPC D22/103, 108
CPC F41C 23/16; F41A 35/02
See application file for complete search history.

(56) **References Cited**

U.S. PATENT DOCUMENTS

D716,902 S *	11/2014	Nason	D22/108
D717,908 S *	11/2014	Montes	D22/108
D721,407 S *	1/2015	Chu	D21/574
D745,104 S *	12/2015	Eitan	D22/108
D745,621 S *	12/2015	Huang	D22/108
2014/0144059 A1 *	5/2014	Geissele	F41C 23/16 42/71.01
2015/0266168 A1 *	9/2015	Geissele	B25B 13/48 29/525.11

* cited by examiner

Primary Examiner — Michael A Pratt

(74) *Attorney, Agent, or Firm* — Merchant & Gould P.C.

(57) **CLAIM**

The ornamental design for a firearm rail, as shown and described.

DESCRIPTION

FIG. 1 is a front left isometric view of a first embodiment of a firearm rail according to the present disclosure; FIG. 2 is a front elevation view of the firearm rail of FIG. 1; FIG. 3 is a rear elevation view of the firearm rail of FIG. 1; FIG. 4 is a right side elevation view of the firearm rail of FIG. 1; FIG. 5 is a left side elevation view of the firearm rail of FIG. 1; FIG. 6 is a top view of the firearm rail of FIG. 1; FIG. 7 is a bottom view of the firearm rail of FIG. 1; FIG. 8 is a front left isometric view of a second embodiment of a firearm rail according to the present disclosure; FIG. 9 is a front elevation view of the firearm rail of FIG. 8; FIG. 10 is a rear elevation view of the firearm rail of FIG. 8; FIG. 11 is a right side elevation view of the firearm rail of FIG. 8; FIG. 12 is a left side elevation view of the firearm rail of FIG. 8; FIG. 13 is a top view of the firearm rail of FIG. 8; FIG. 14 is a bottom view of the firearm rail of FIG. 8; FIG. 15 is a front left isometric view of a third embodiment of a firearm rail according to the present disclosure; FIG. 16 is a front elevation view of the firearm rail of FIG. 15; FIG. 17 is a rear elevation view of the firearm rail of FIG. 15; FIG. 18 is a right side elevation view of the firearm rail of FIG. 15; FIG. 19 is a left side elevation view of the firearm rail of FIG. 15; FIG. 20 is a top view of the firearm rail of FIG. 15; and, FIG. 21 is a bottom view of the firearm rail of FIG. 15. The broken lines in the Figures are for illustrative purposes only and form no part of the claimed design.

1 Claim, 12 Drawing Sheets

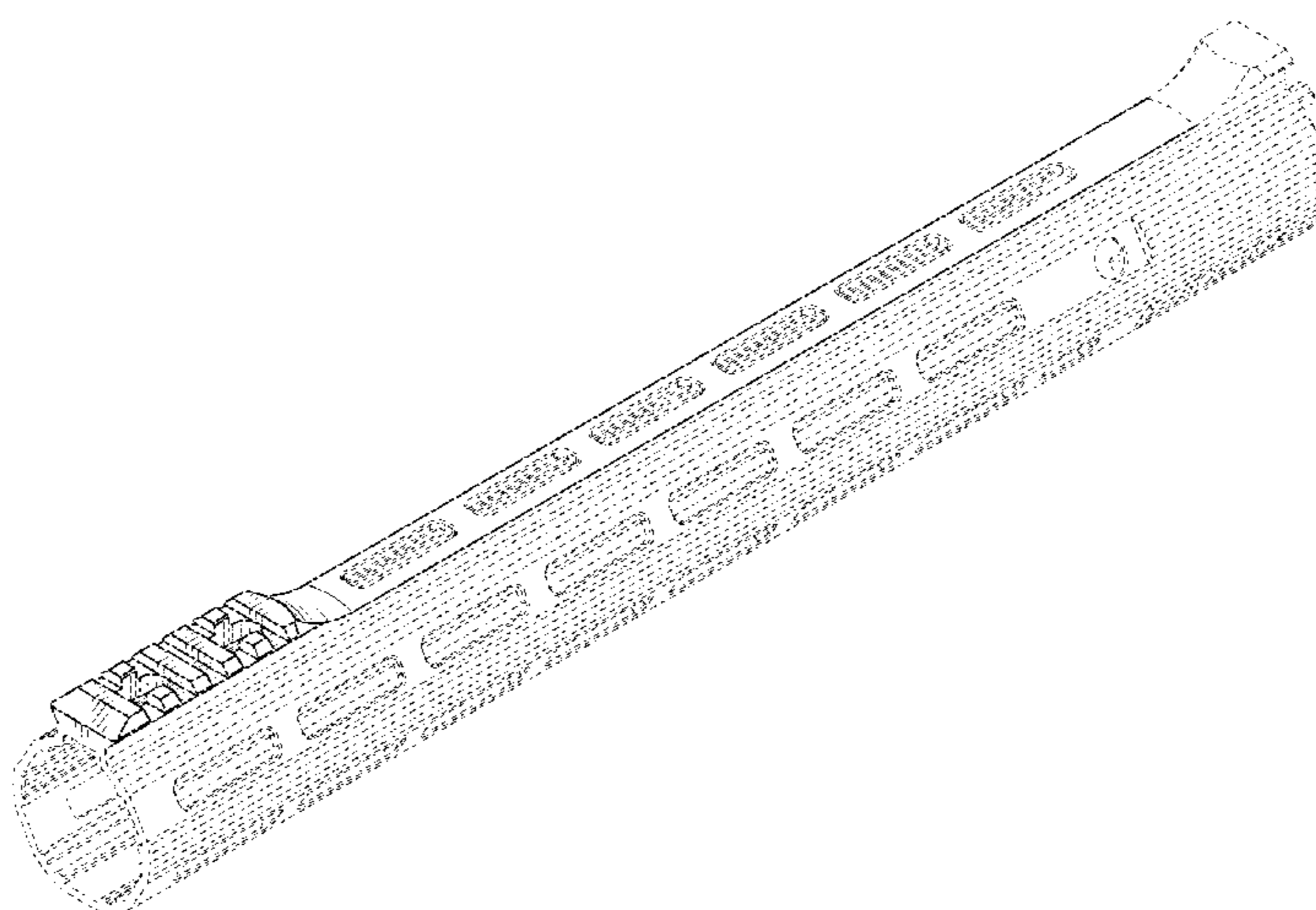

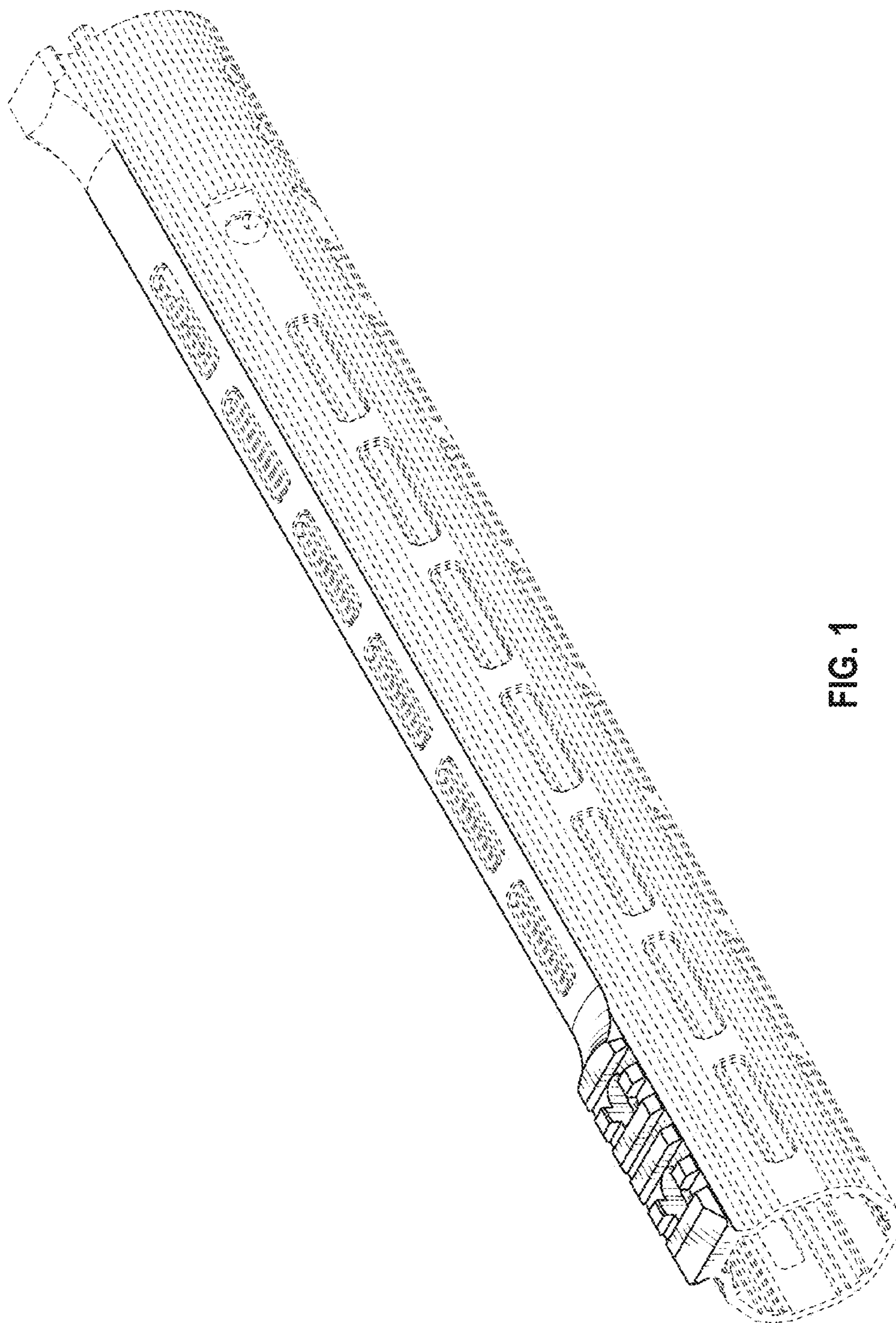

FIG. 1

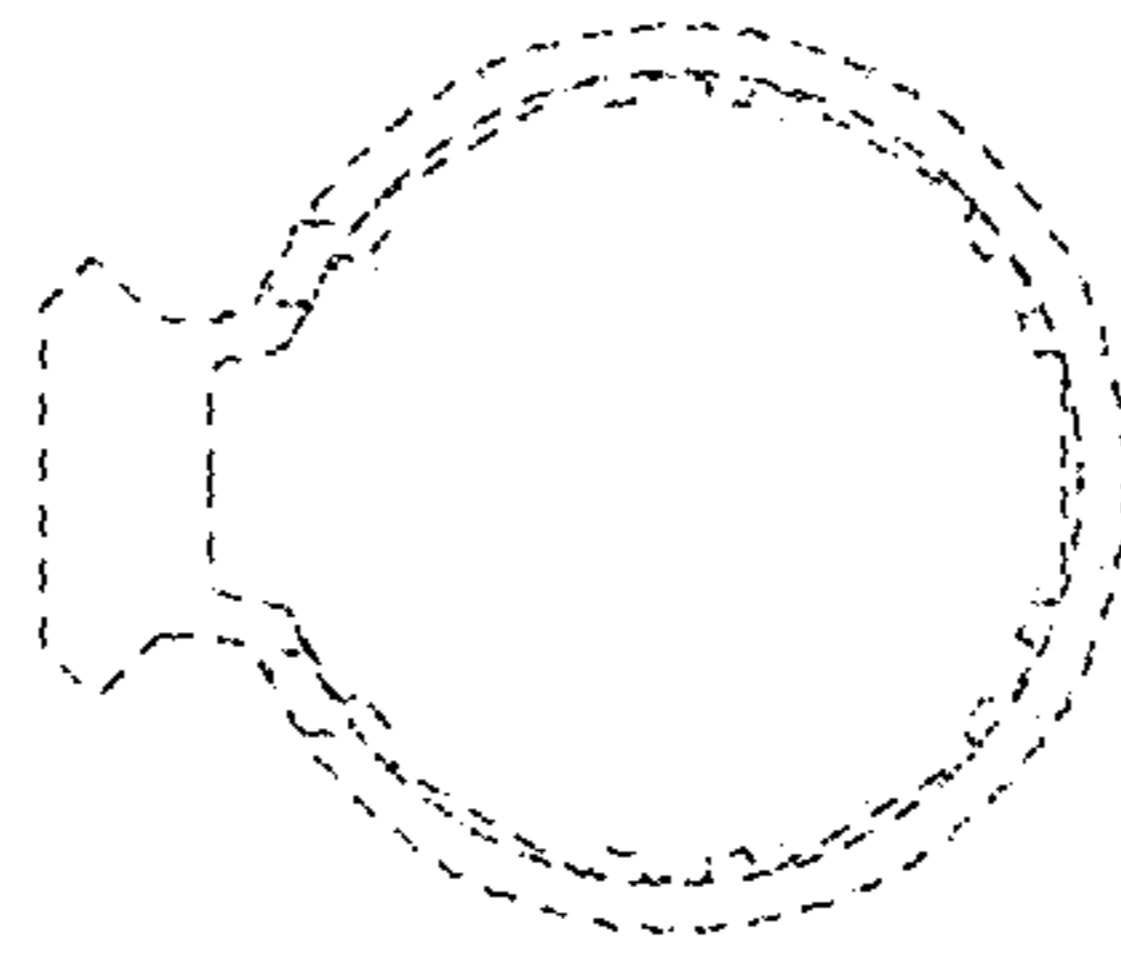

FIG. 3

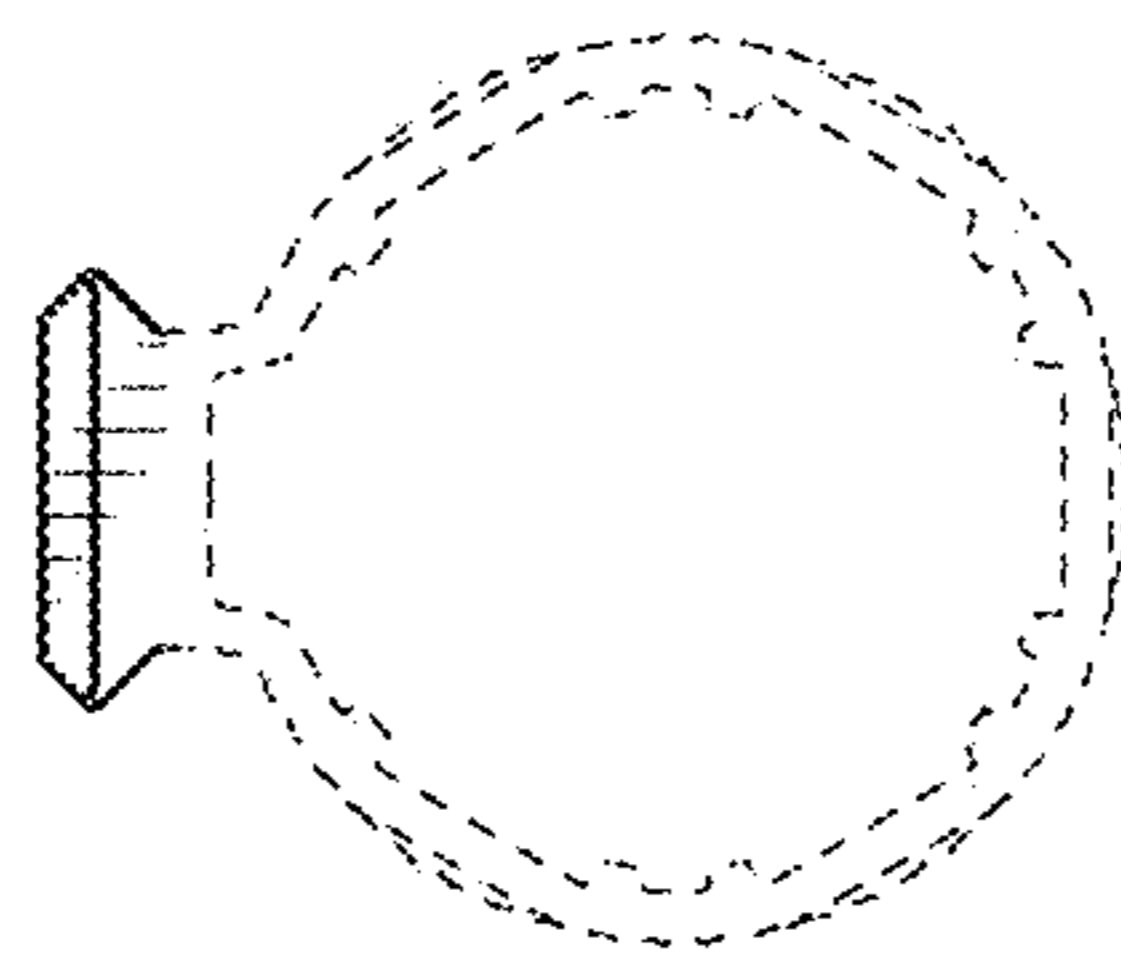

FIG. 2

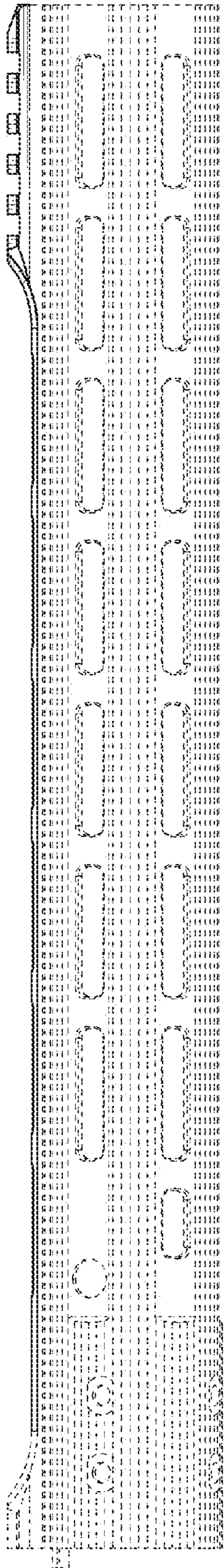

FIG. 4

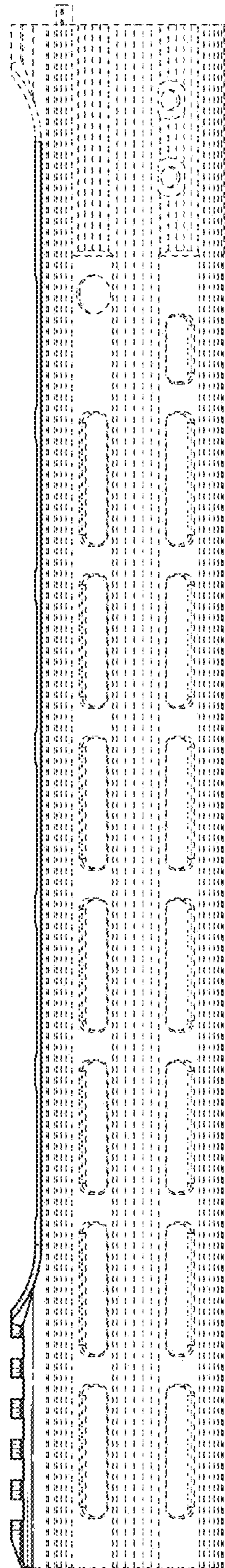

FIG. 5

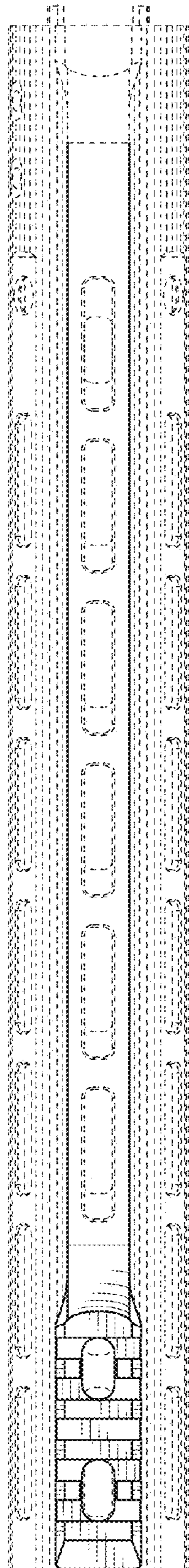

FIG. 6

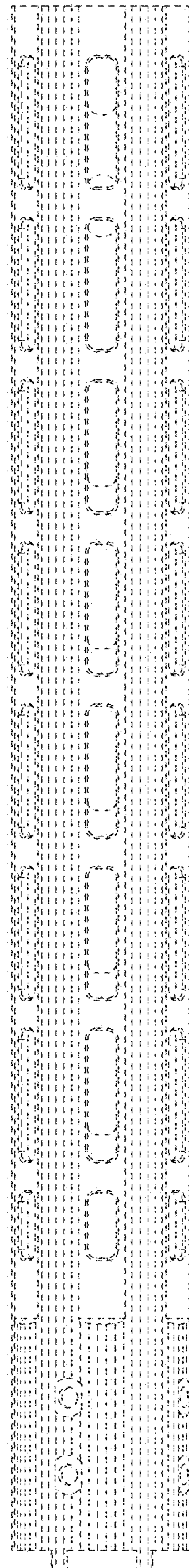

FIG. 7

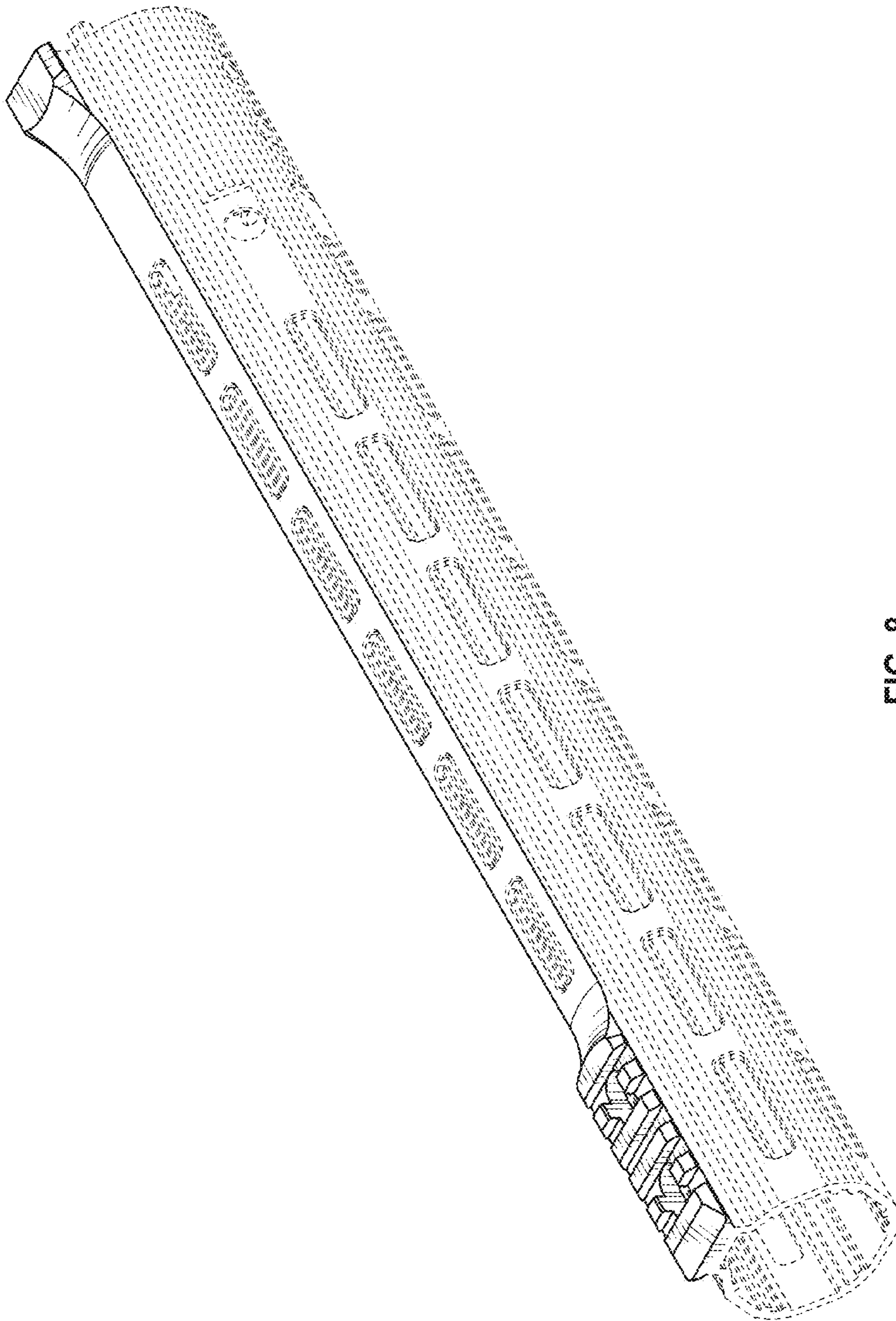

FIG. 8

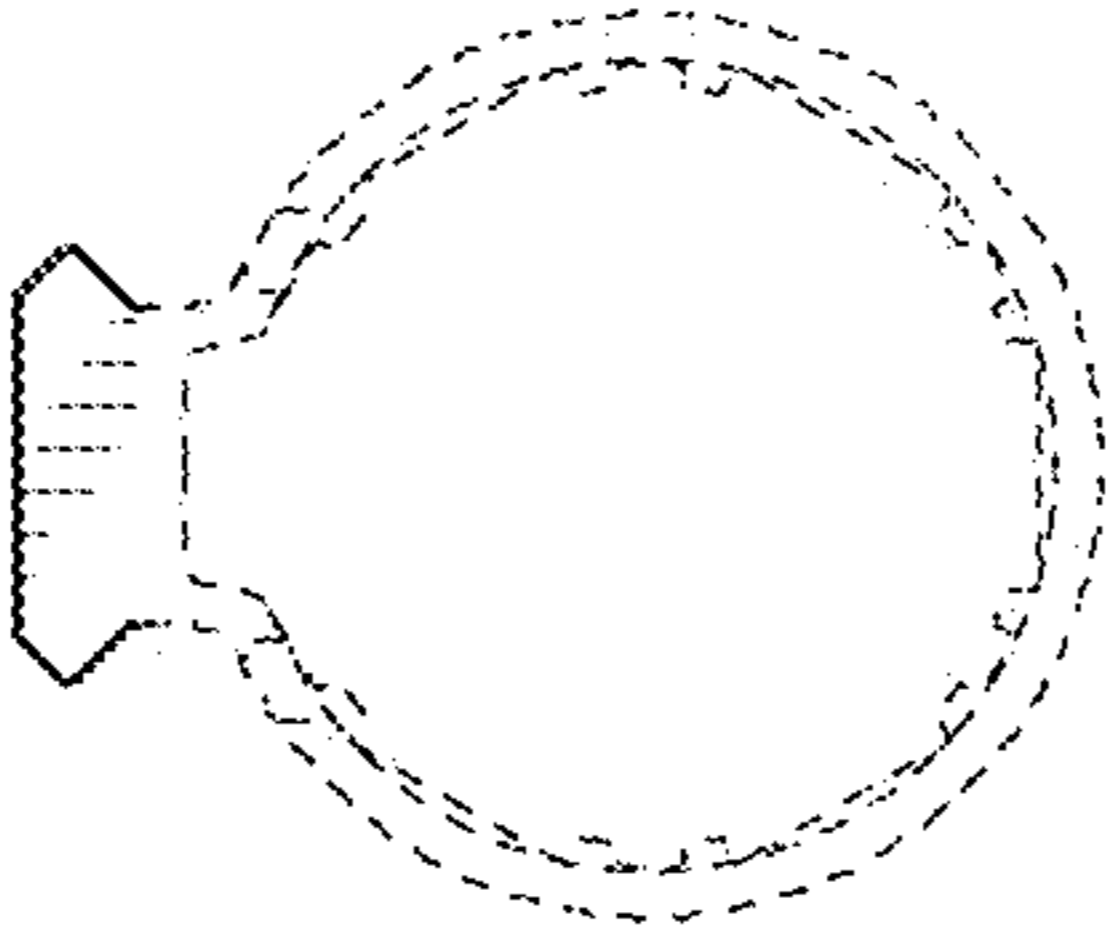

FIG. 10

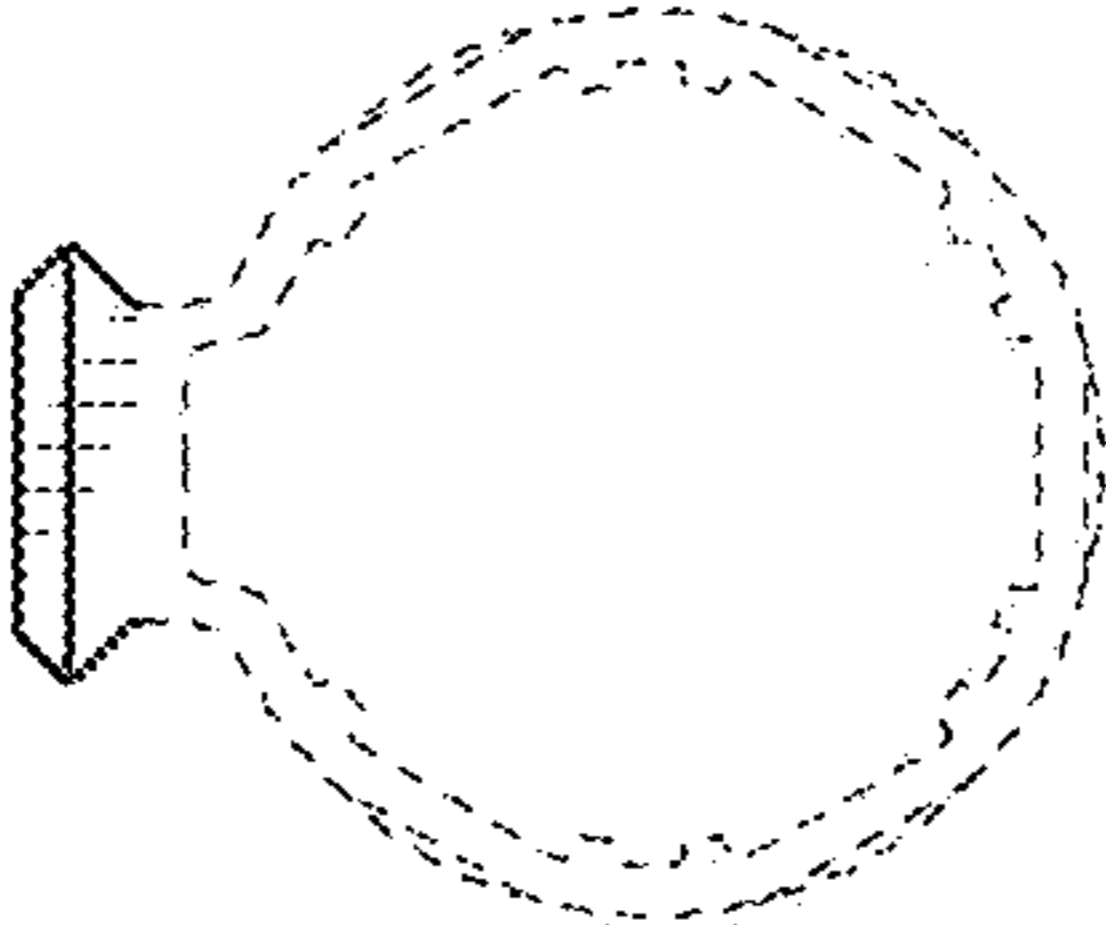

FIG. 9

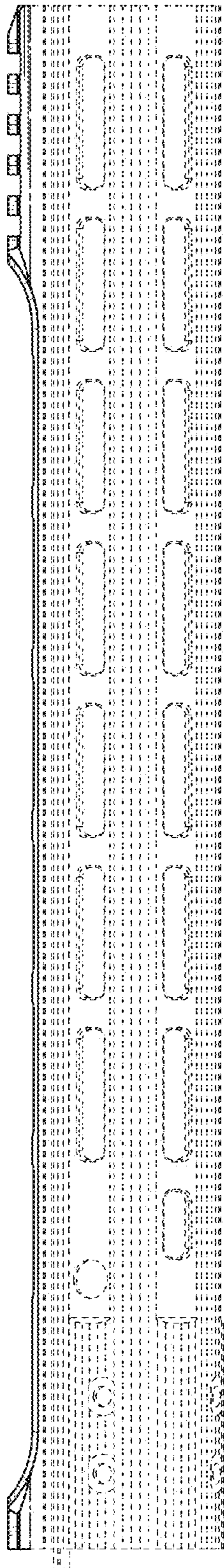

FIG. 11

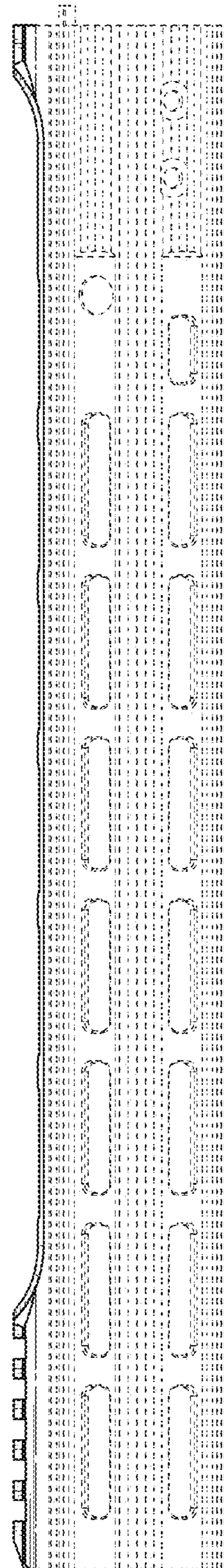

FIG. 12

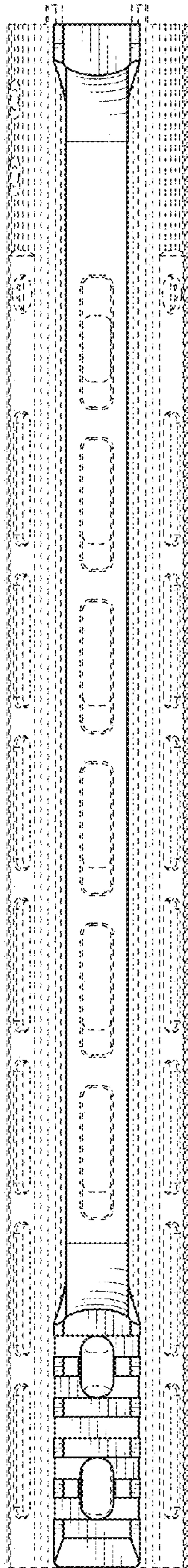

FIG. 13

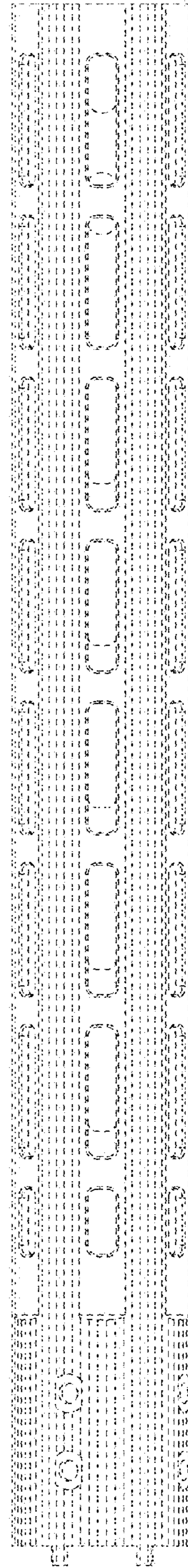

FIG. 14

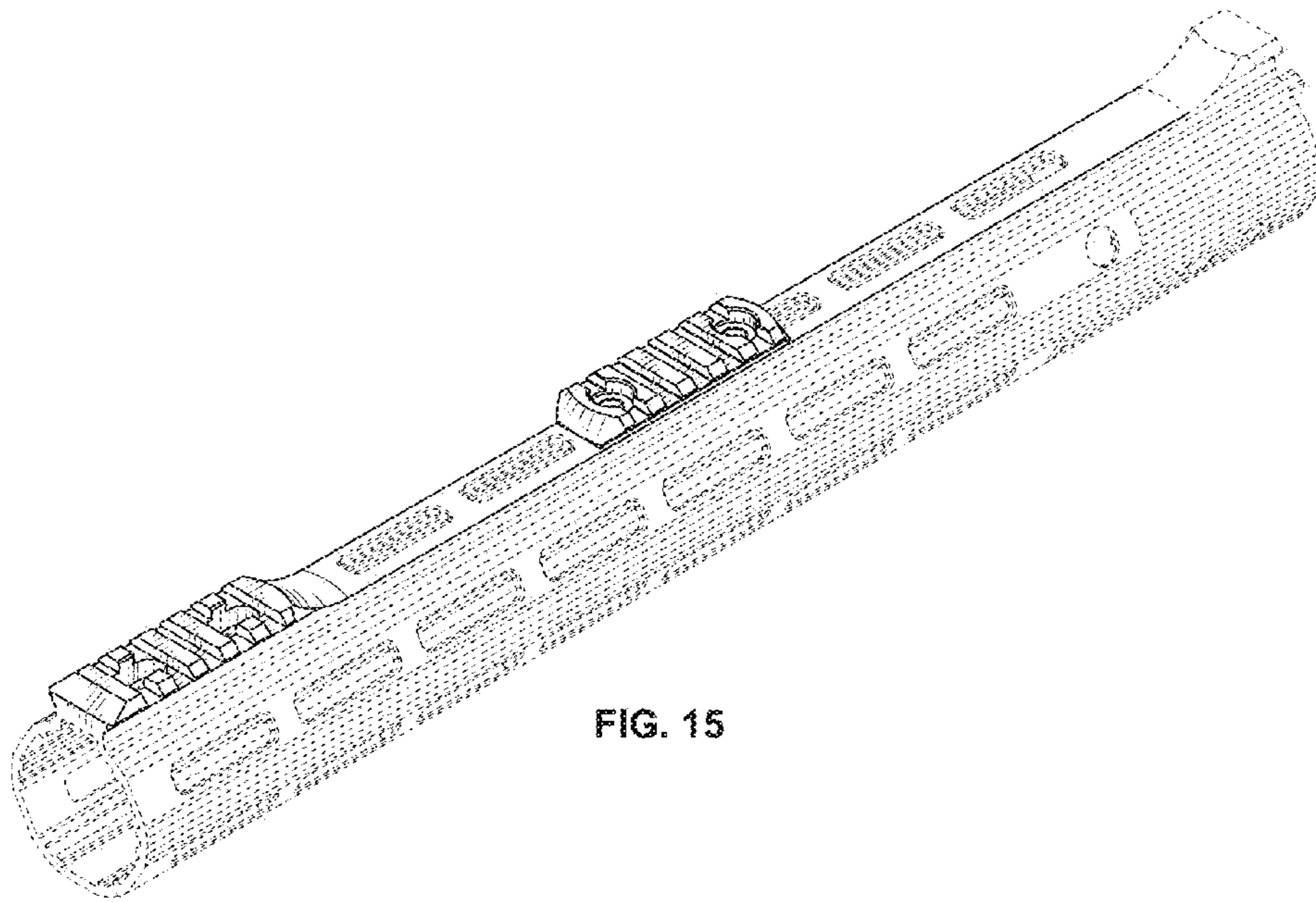

FIG. 15

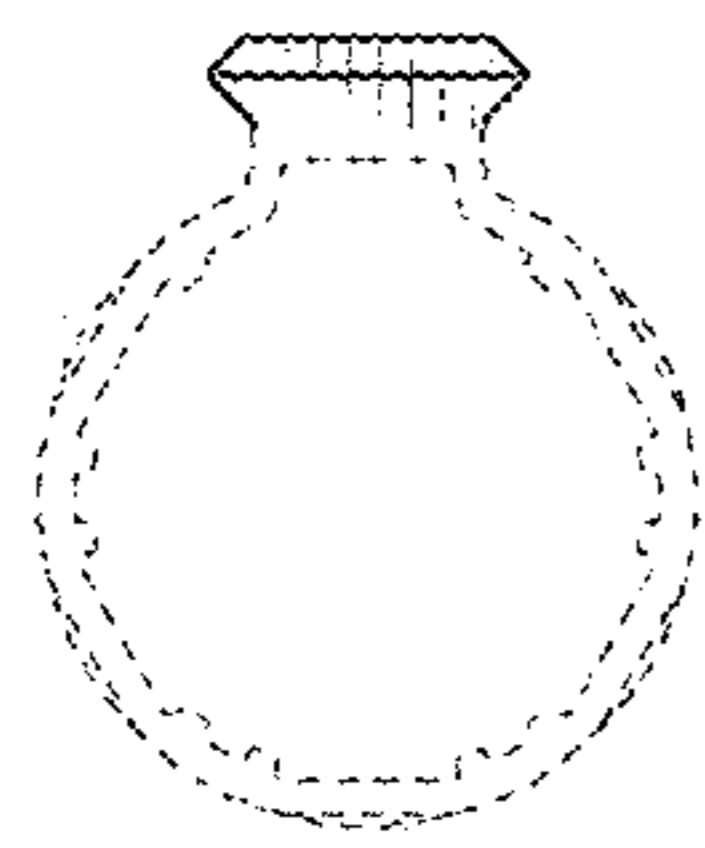

FIG. 16

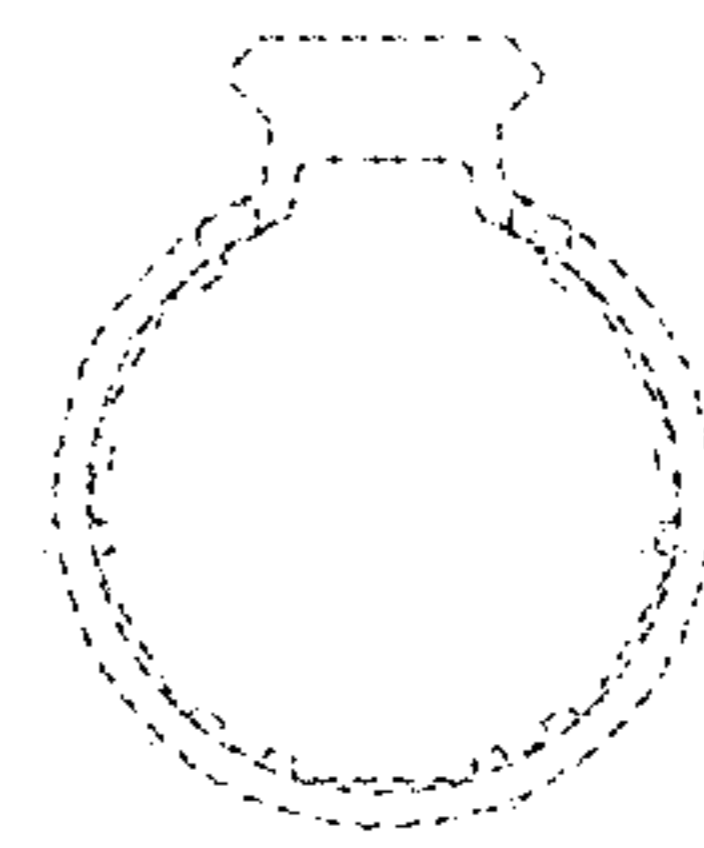

FIG. 17

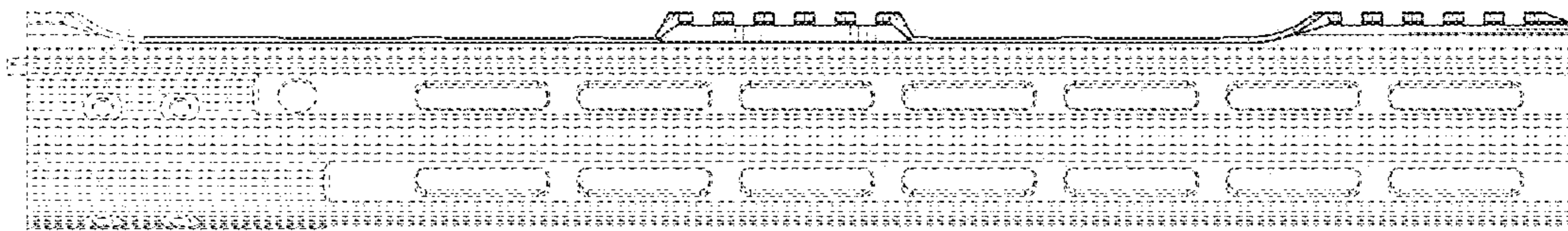

FIG. 18

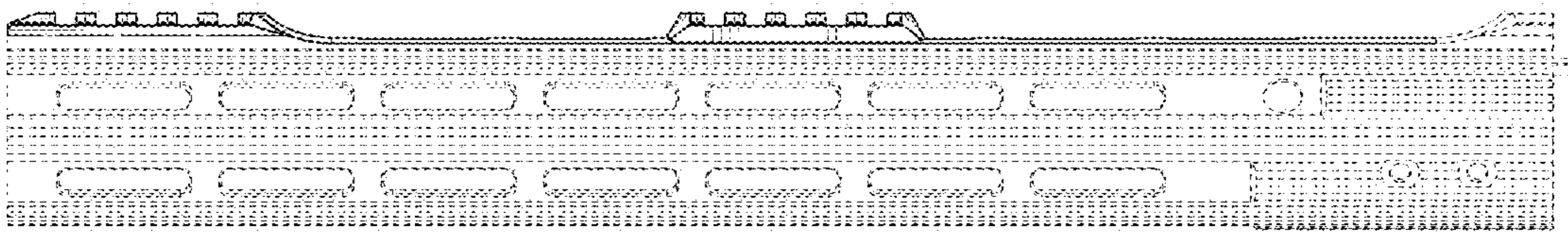

FIG. 19

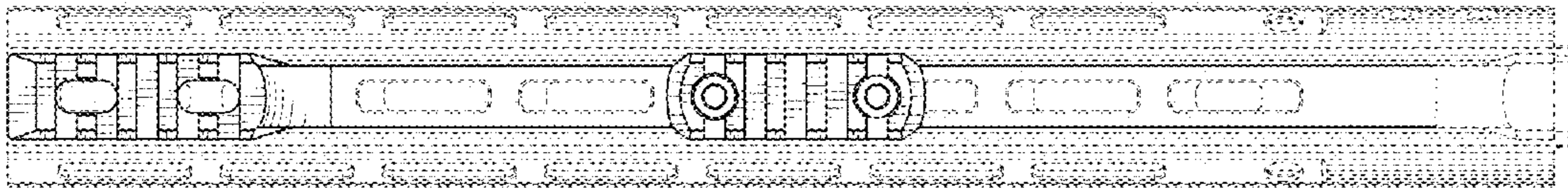

FIG. 20

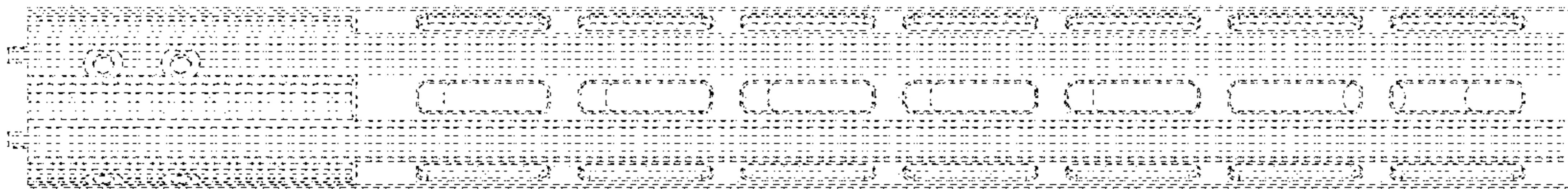

FIG. 21