



US00D754263S

(12) **United States Design Patent**
Wolff

(10) **Patent No.:** **US D754,263 S**
(45) **Date of Patent:** **** Apr. 19, 2016**

(54) **TOY BLOCK**

(71) Applicant: **A Diva Difference, LLC**, Loveland, CO (US)

(72) Inventor: **Alexandra Wolff**, Loveland, CO (US)

(73) Assignee: **A Diva Difference, LLC**, Loveland, CO (US)

(**) Term: **14 Years**

(21) Appl. No.: **29/524,383**

(22) Filed: **Apr. 20, 2015**

(51) **LOC (10) Cl.** **21-01**

(52) **U.S. Cl.**
USPC **D21/499**

(58) **Field of Classification Search**
USPC D21/333, 373, 386, 389, 404, 468, 470, D21/471, 475, 484-505; 446/69, 85, 446/102-128; 434/167, 208, 259, 403; 273/153, 156, 160; D3/304, 314; D24/101; D9/640; 220/23.4; 40/720
CPC A63H 33/04; A63H 33/06; A63H 33/062; A63H 33/08; A63H 33/088; A63F 9/12; A63F 9/1224

See application file for complete search history.

(56) **References Cited**

U.S. PATENT DOCUMENTS

D276,171 S * 10/1984 Filipowicz D21/468
4,667,962 A * 5/1987 Ishiyama A63F 9/12
273/157 R

D296,451 S * 6/1988 Ming D21/470
D359,315 S * 6/1995 Tacey D21/499
D377,396 S * 1/1997 Maurel D21/499
D380,240 S * 6/1997 Johnson, Jr. D21/470
D464,682 S * 10/2002 Lin D21/499
D480,437 S * 10/2003 Stoneberg D21/499
D698,869 S * 2/2014 Strzelewicz D21/499
D722,658 S * 2/2015 Marschall D21/499
2003/0148700 A1 * 8/2003 Arlinsky A63H 33/04
446/91
2010/0120322 A1 * 5/2010 Vicentelli A63H 33/04
446/92
2012/0122059 A1 * 5/2012 Schweikardt A63H 33/04
434/118

* cited by examiner

Primary Examiner — Cynthia M Chin

(74) *Attorney, Agent, or Firm* — Mestechkin Law Group PC

(57) **CLAIM**

The ornamental design for a toy block, as shown and described.

DESCRIPTION

FIG. 1 is a top front right isometric view of the toy block according to one embodiment of my new design; FIG. 2 is a top front left isometric view thereof; FIG. 3 is a bottom rear right isometric view thereof; FIG. 4 is a bottom rear left elevation view thereof; FIG. 5 is a front elevation view thereof; FIG. 6 is a rear elevation view thereof; FIG. 7 is a left elevation view thereof; FIG. 8 is a right elevation view thereof; FIG. 9 is a top plan view thereof; and, FIG. 10 is a bottom plan view thereof.

1 Claim, 2 Drawing Sheets

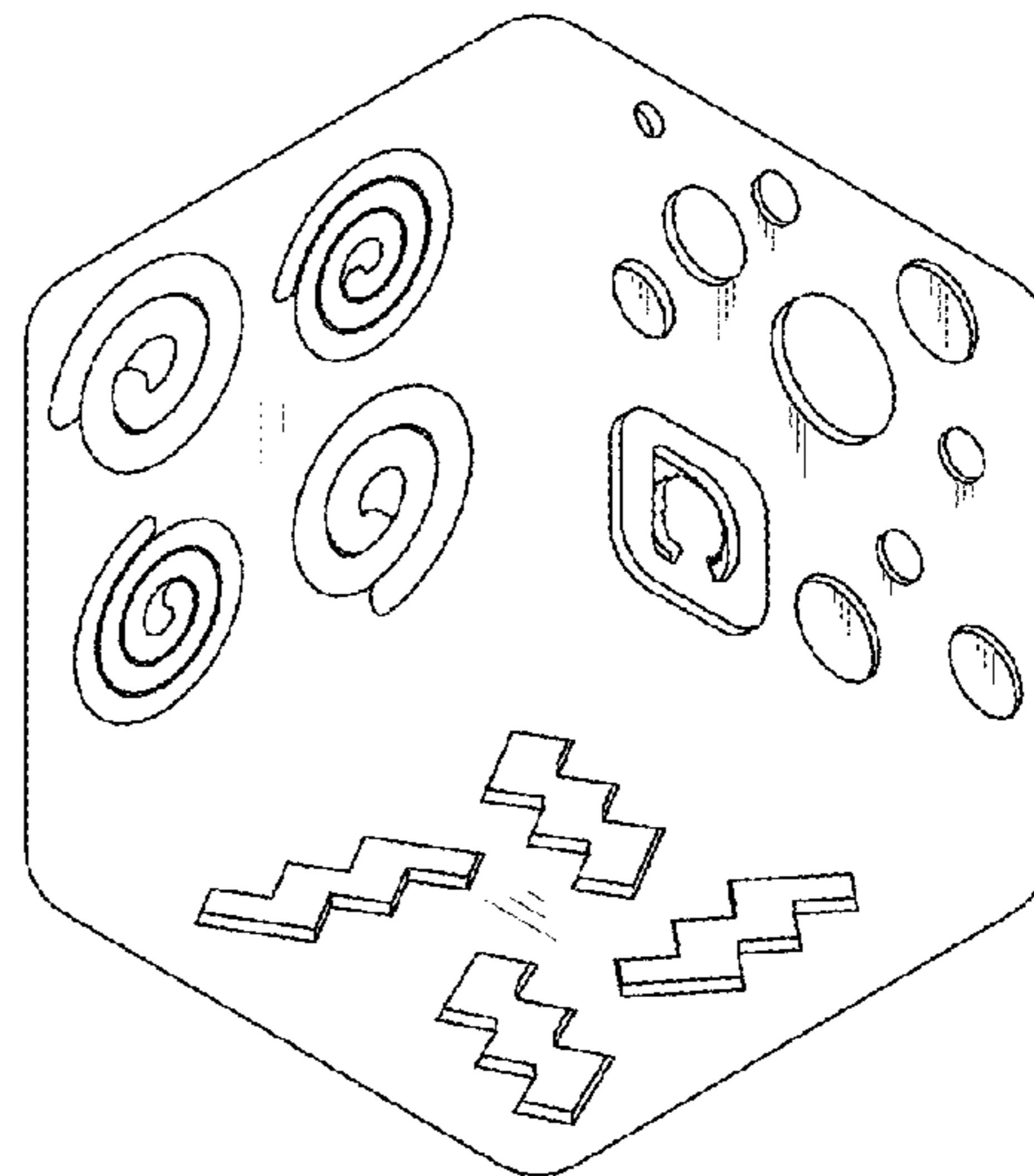
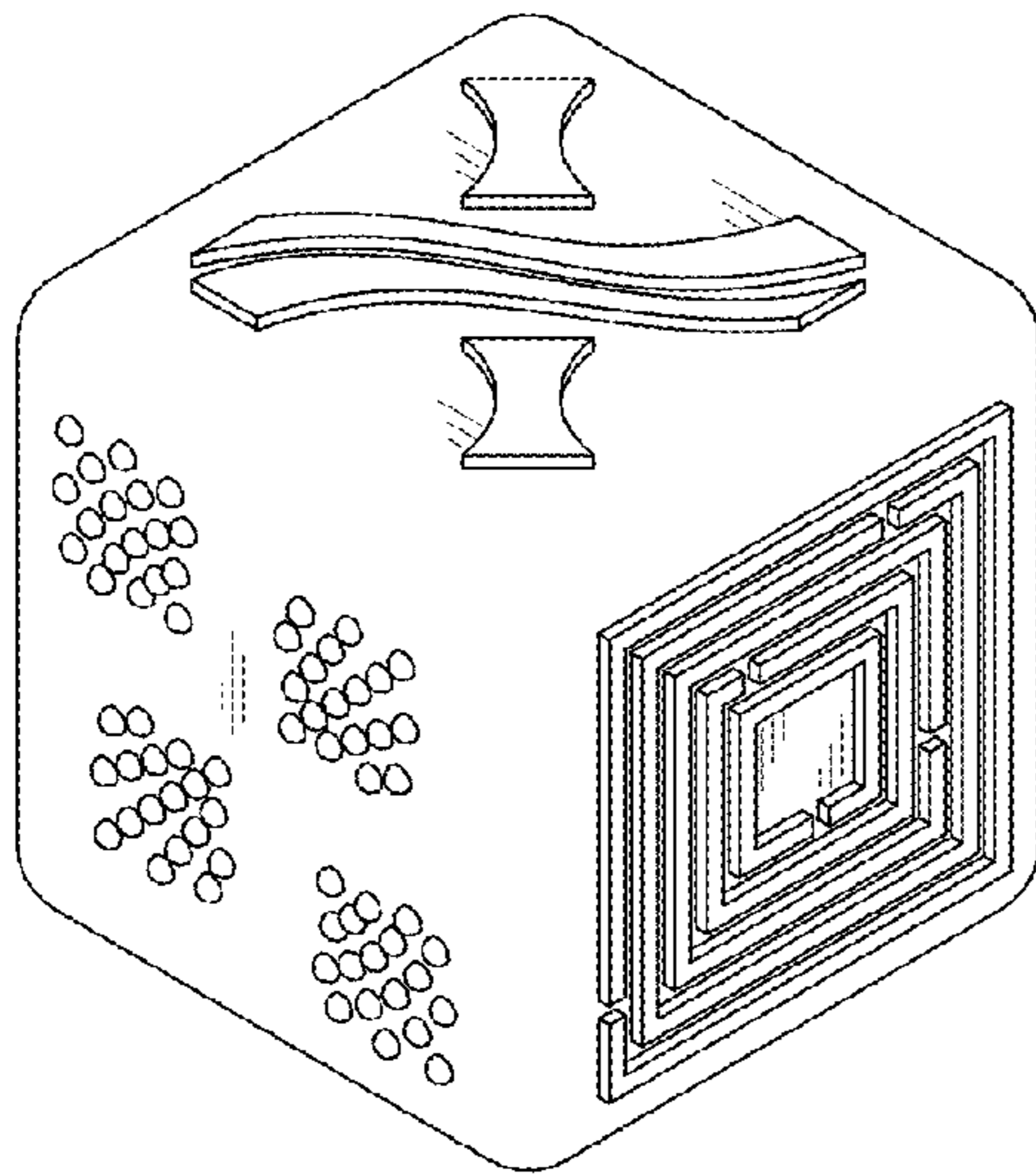

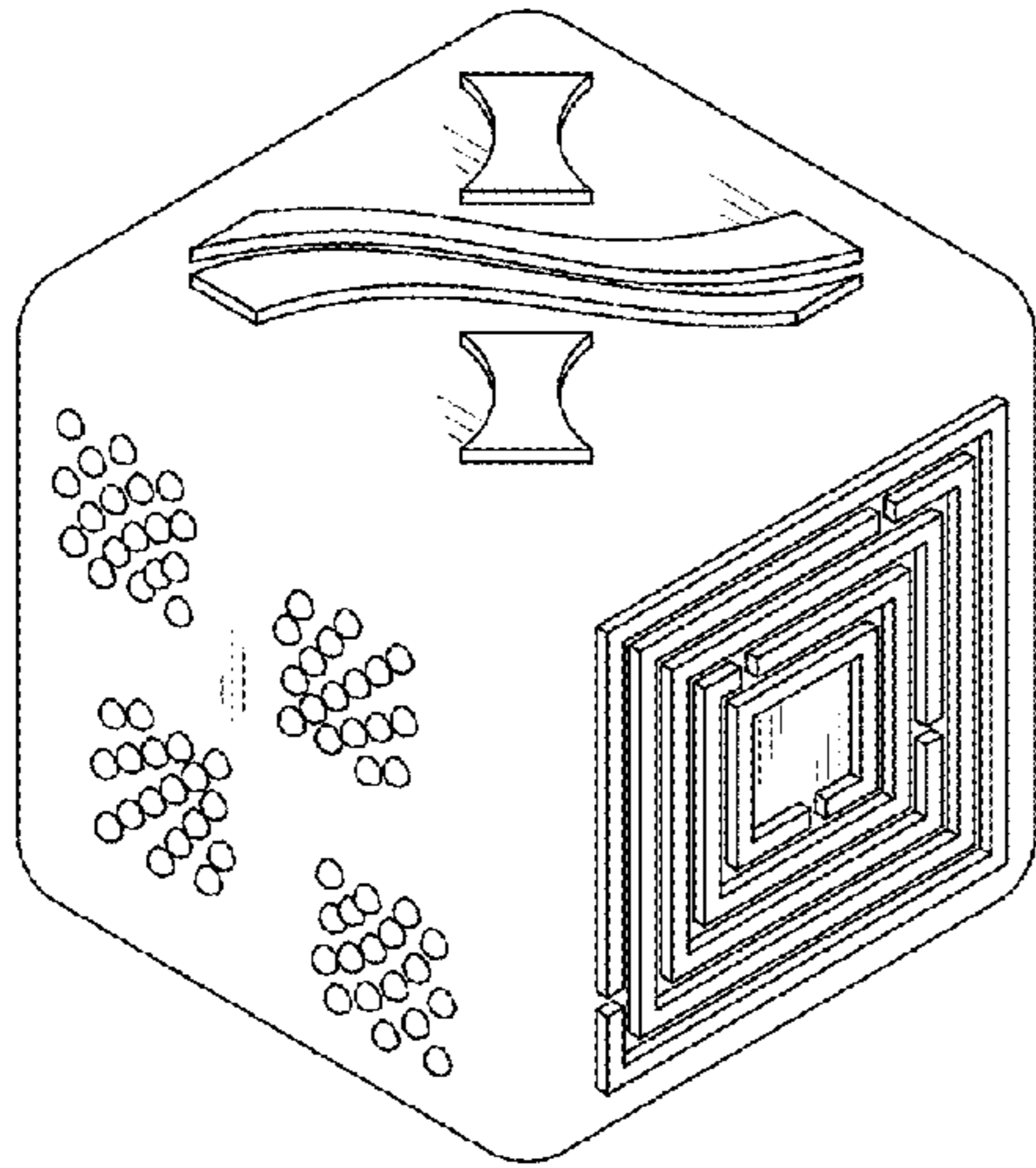

FIG. 1

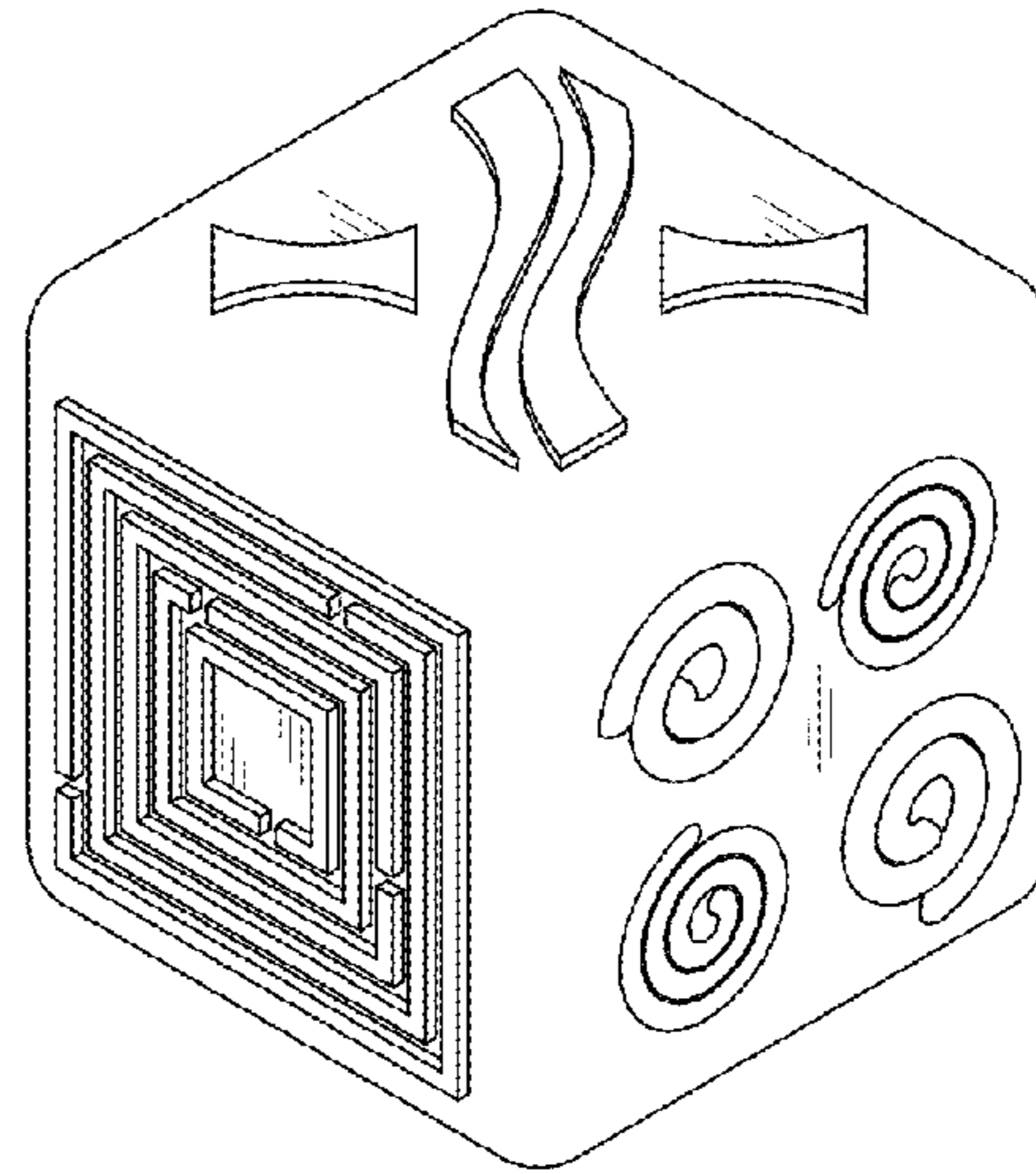

FIG. 2

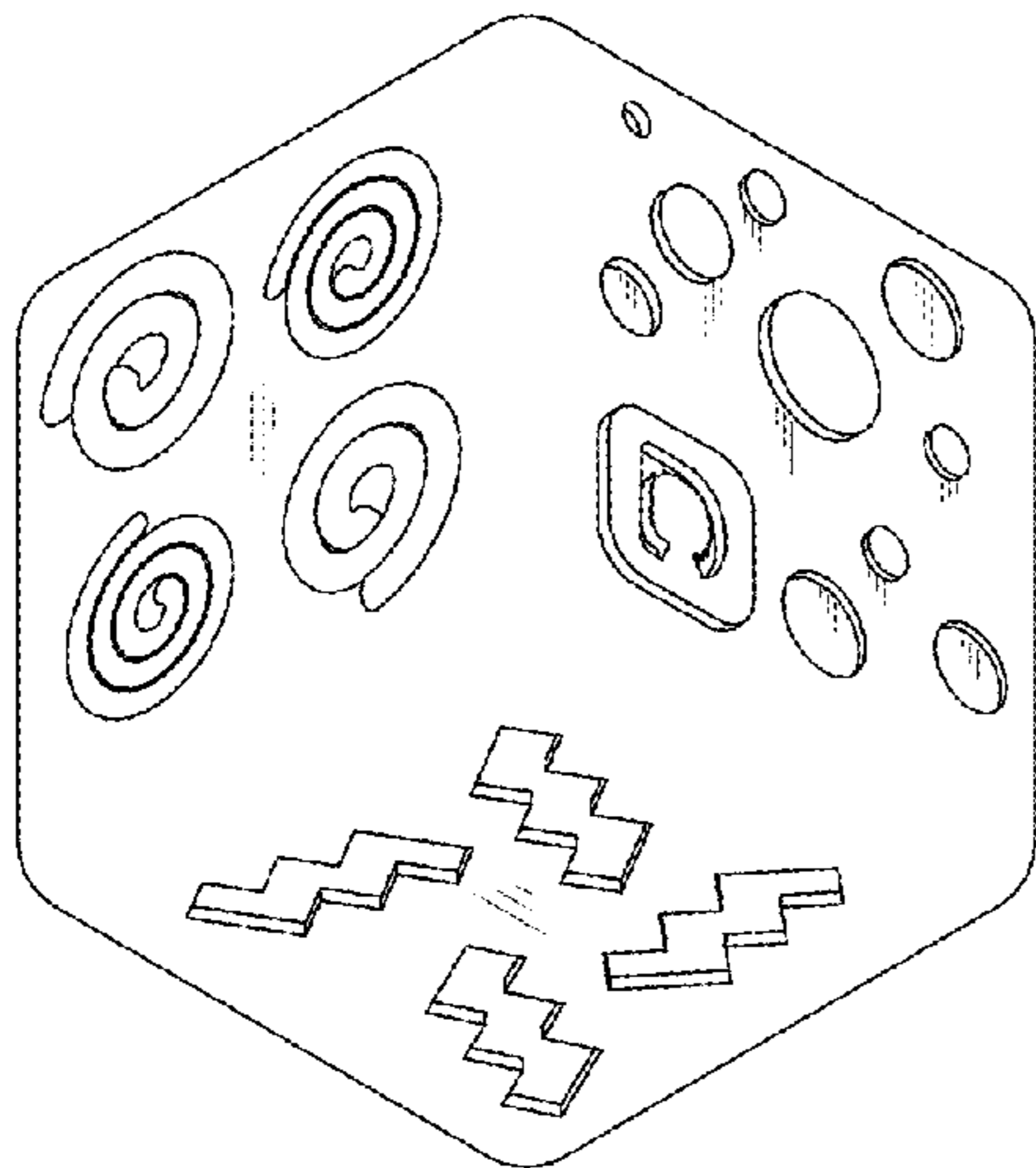

FIG. 3

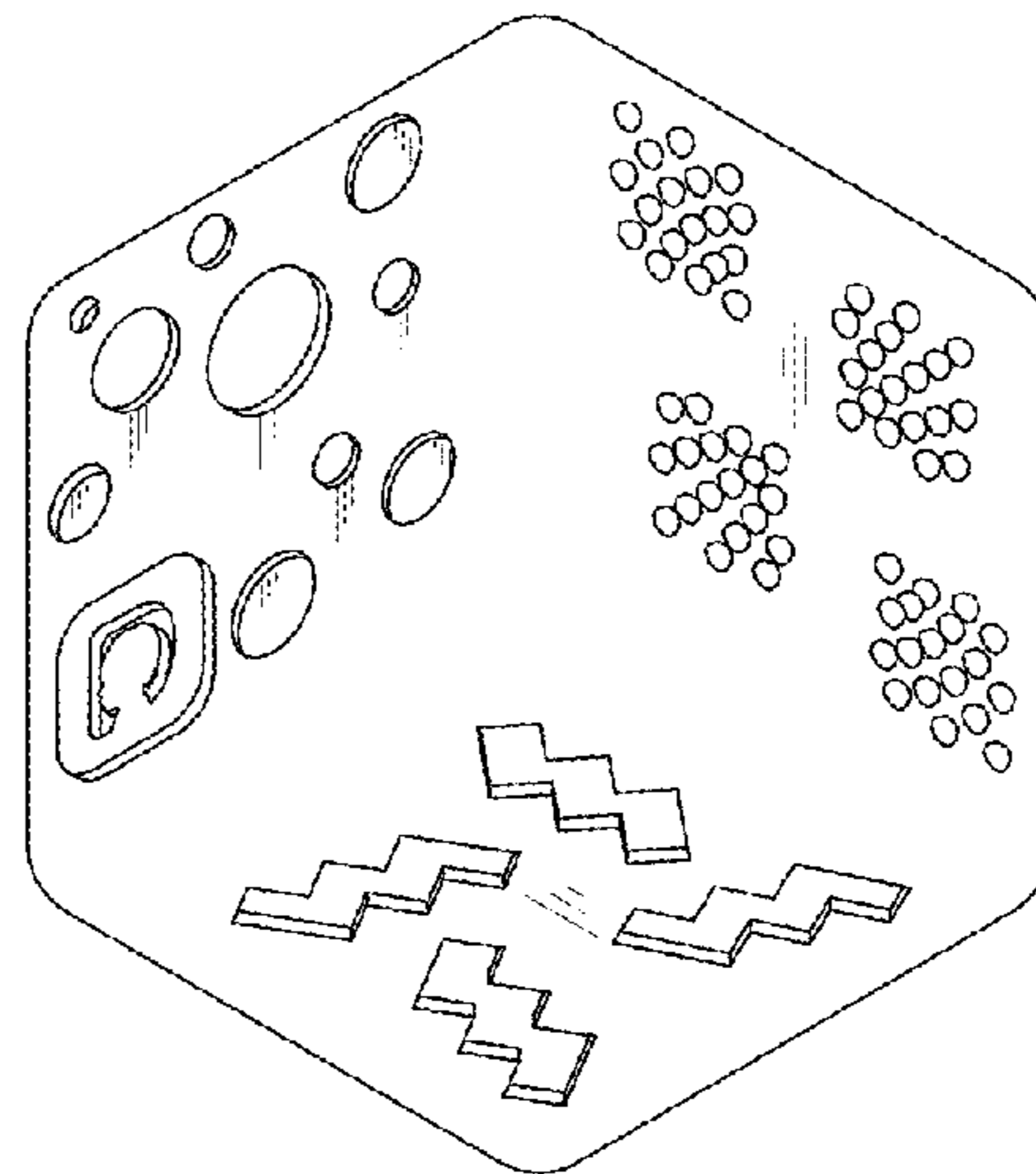

FIG. 4

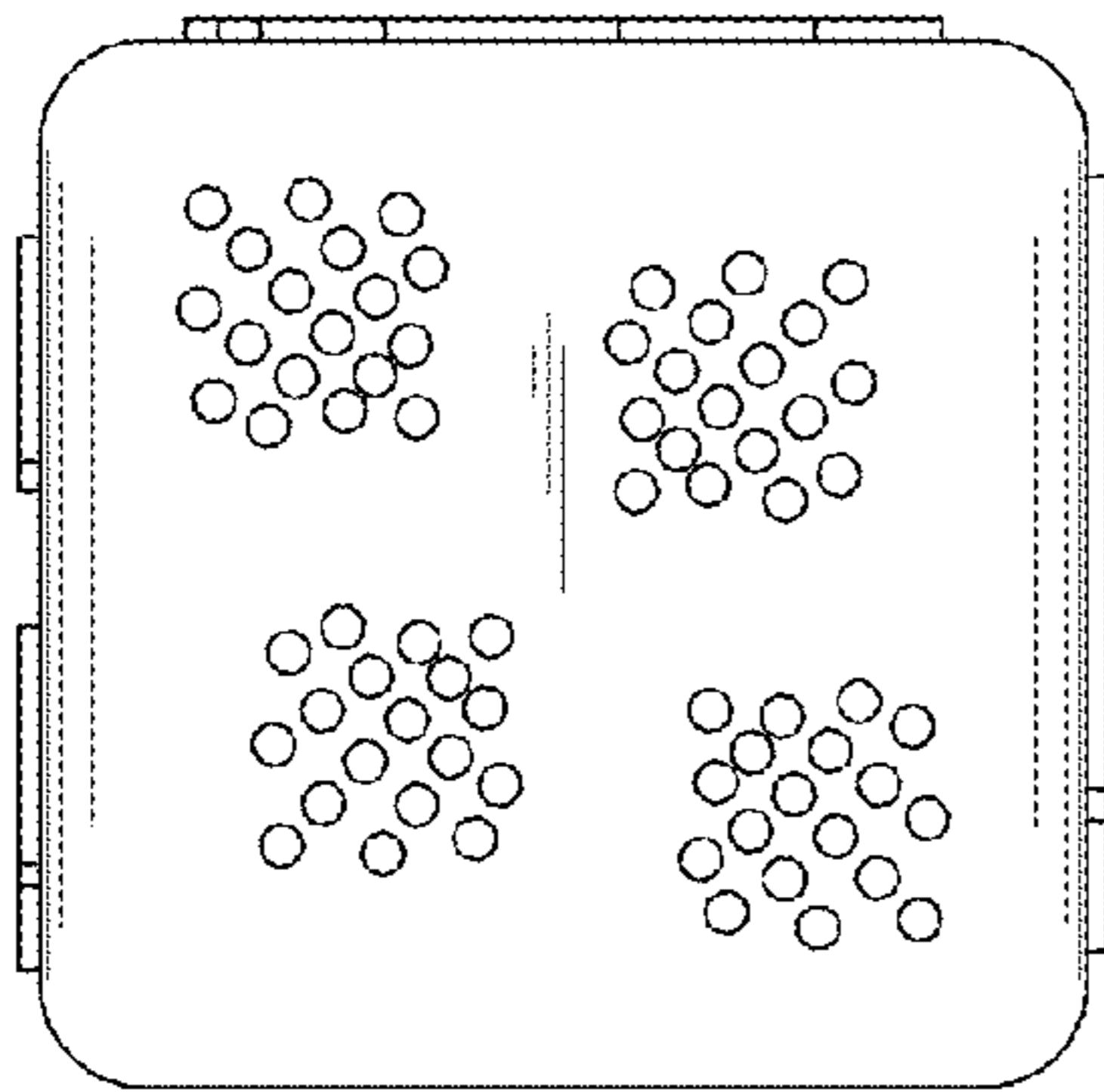

FIG. 5

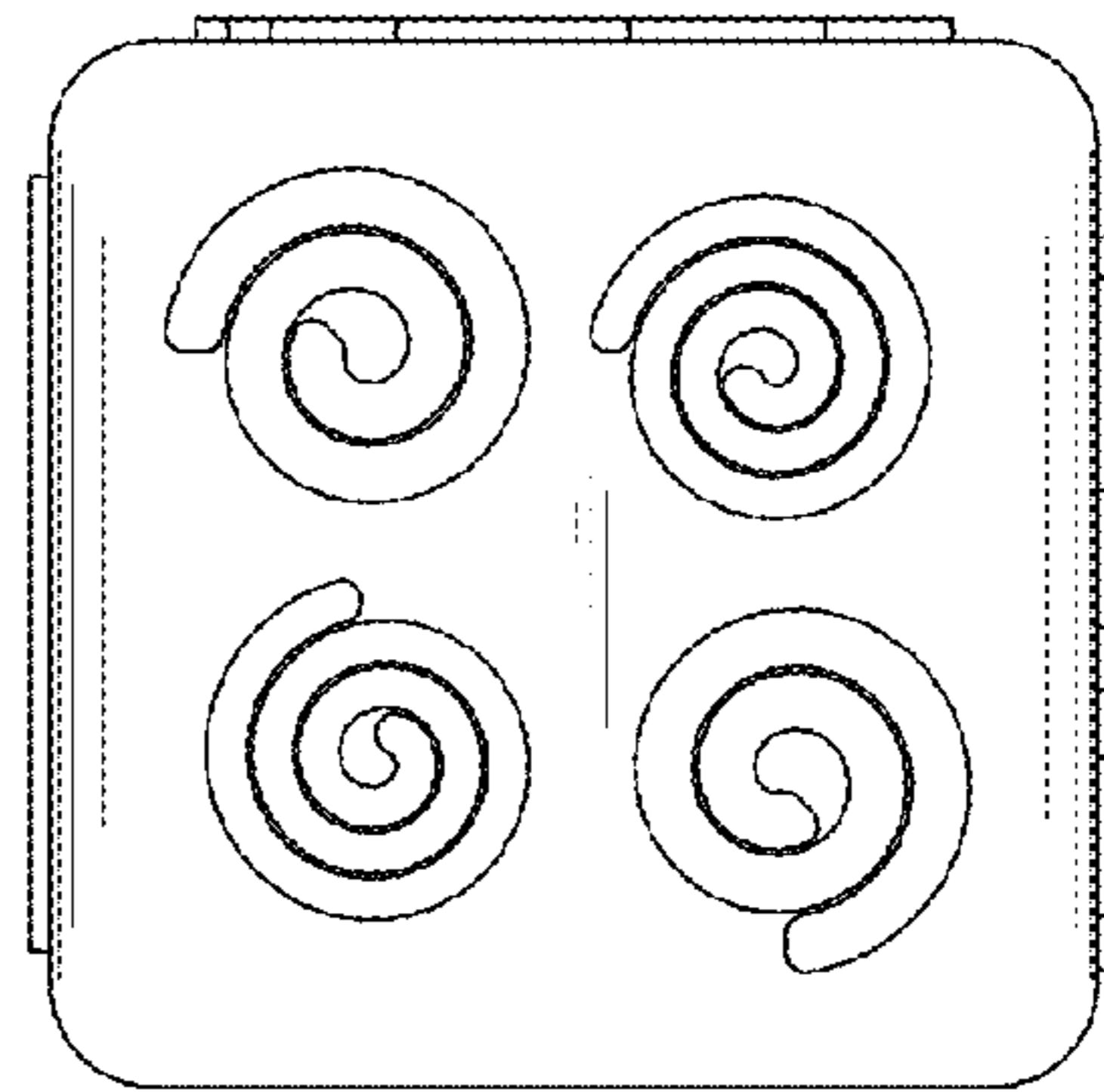

FIG. 6

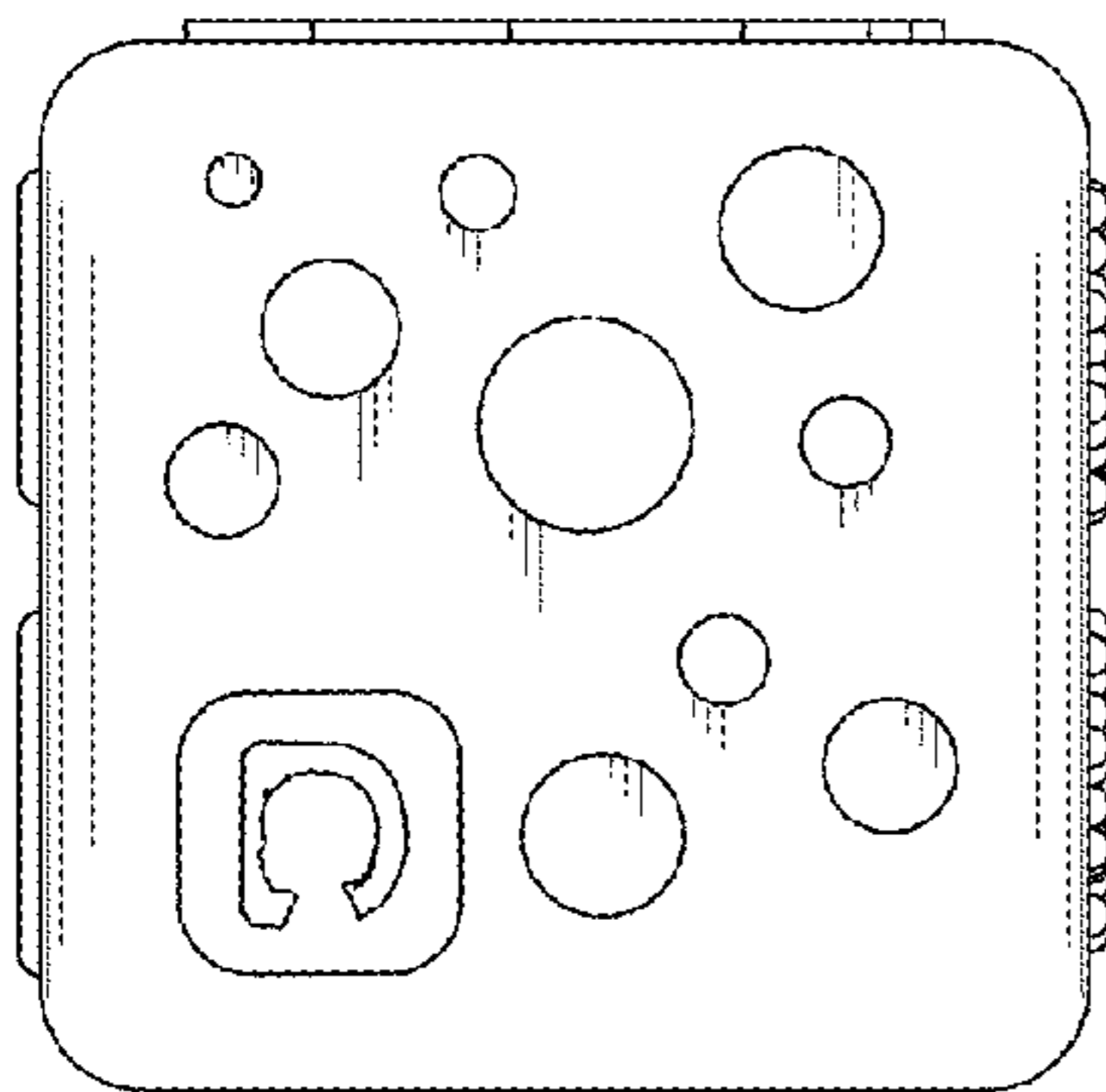

FIG. 7

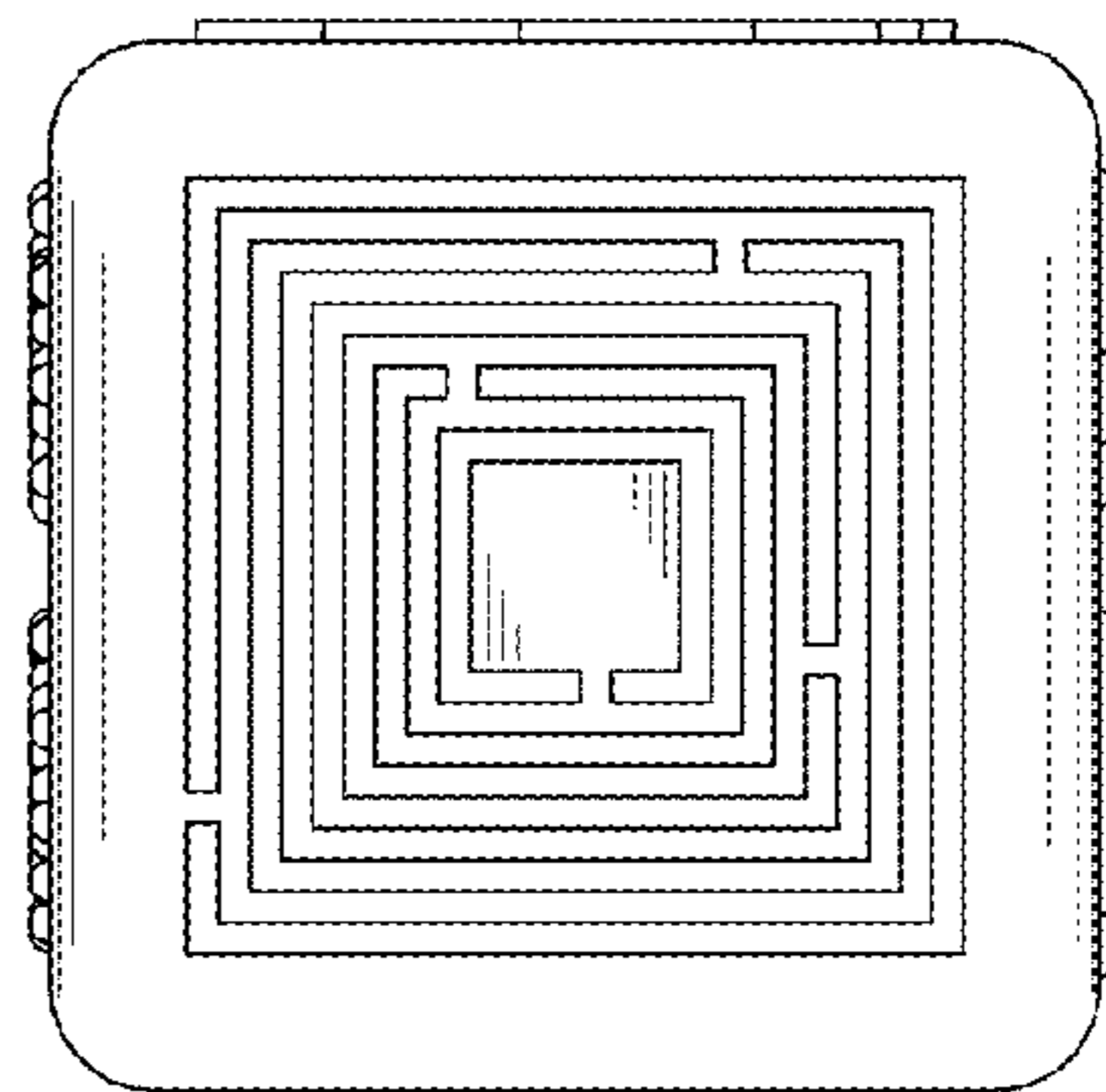

FIG. 8

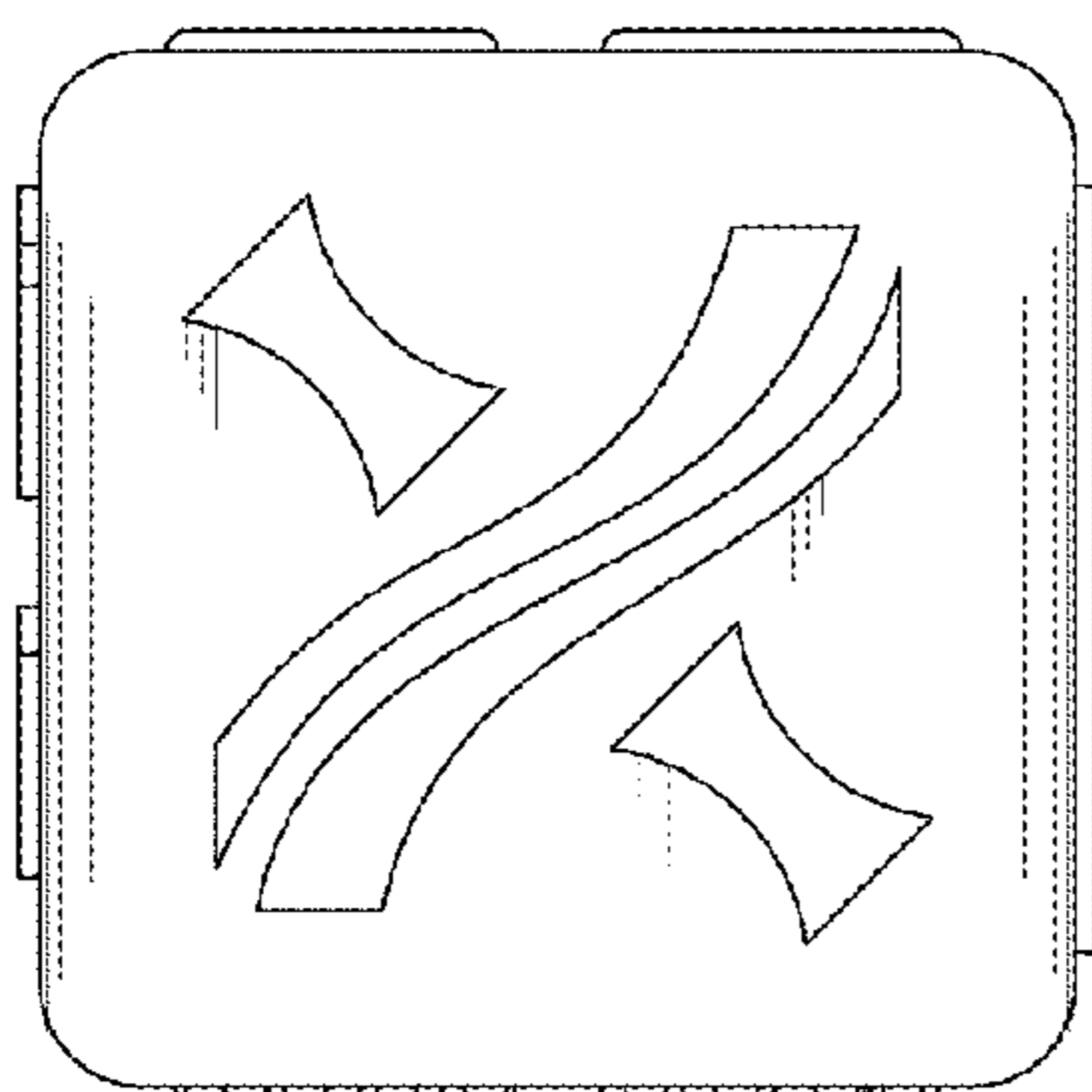

FIG. 9

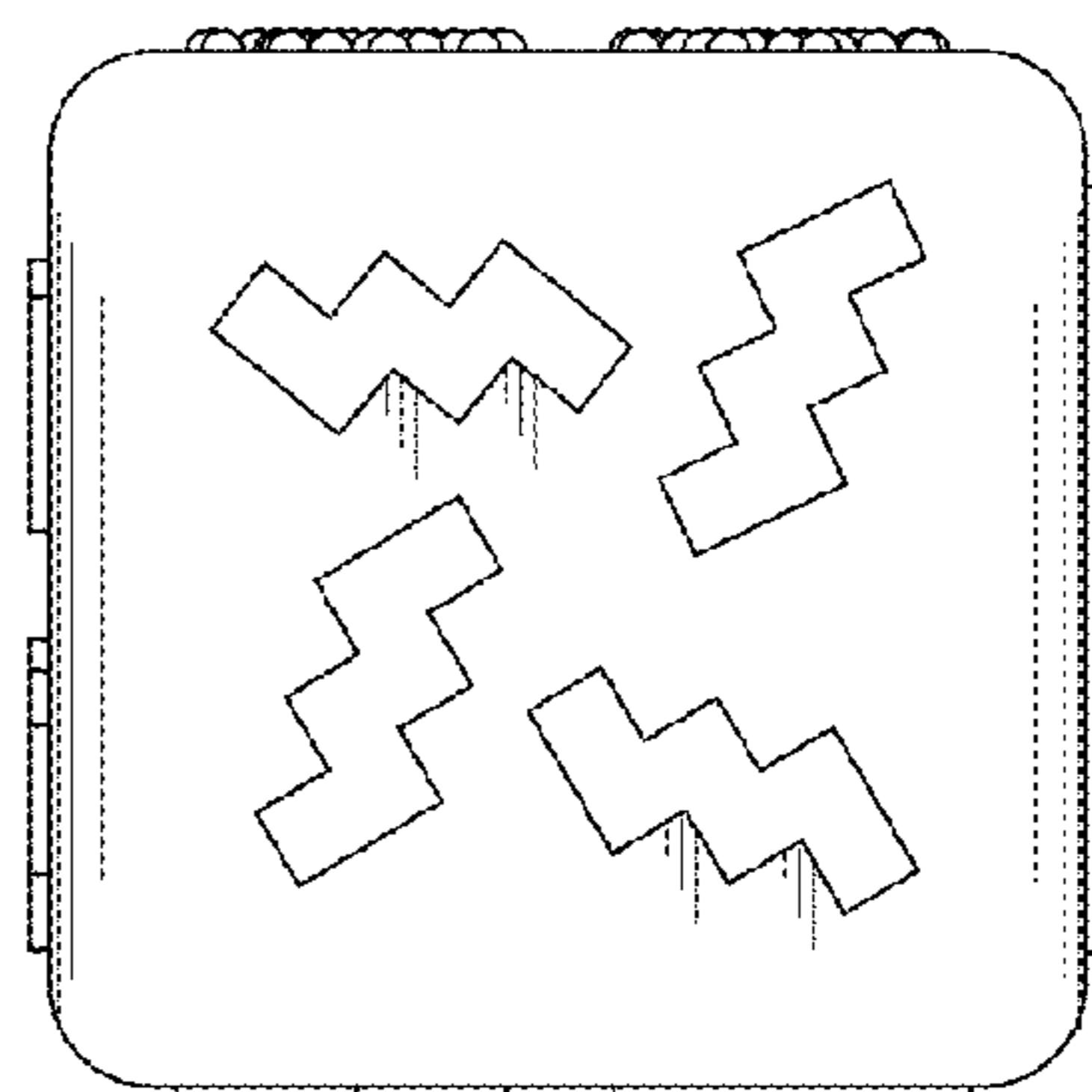

FIG. 10