



US00D754114S

(12) **United States Design Patent**
Curtis et al.

(10) **Patent No.:** **US D754,114 S**
(45) **Date of Patent:** **** Apr. 19, 2016**

(54) **ELECTRONIC DEVICE CASE**

(71) Applicants: **Jason Curtis**, Antioch, TN (US); **David M. Reynolds**, Mount Juliet, TN (US); **Eugenio J. Duarte**, Mount Juliet, TN (US); **Jennifer Ann Murphy**, Nashville, TN (US)

(72) Inventors: **Jason Curtis**, Antioch, TN (US); **David M. Reynolds**, Mount Juliet, TN (US); **Eugenio J. Duarte**, Mount Juliet, TN (US); **Jennifer Ann Murphy**, Nashville, TN (US)

(73) Assignee: **Griffin Technology, Inc**, Nashville, TN (US)

(**) Term: **14 Years**

(21) Appl. No.: **29/477,459**

(22) Filed: **Dec. 23, 2013**

(51) **LOC (10) Cl.** **14-03**

(52) **U.S. Cl.**
USPC **D14/250**

(58) **Field of Classification Search**
USPC D14/250–253, 440, 203.3–203.7, 217, D14/496, 248, 238.1, 240, 447; D3/201, D3/218, 269, 301, 273, 303; D13/103, D13/107–108; 220/4.02; 248/309.1; 361/679.56; 379/426, 433.11, 455; 455/575.1, 575.8; 190/100; 206/305, 206/320
CPC A45C 2011/002; A45C 11/00; A45C 13/002; A45C 2011/003; H04M 1/0283; H04M 1/0202

See application file for complete search history.

(56) **References Cited**

U.S. PATENT DOCUMENTS

D544,437	S	*	6/2007	Hussaini et al.	D13/107
D638,012	S	*	5/2011	Tian et al.	D14/341
D647,475	S	*	10/2011	Spencer et al.	D13/108
D652,377	S	*	1/2012	Butts et al.	D13/107
D667,403	S	*	9/2012	Maus	D14/385
D667,823	S	*	9/2012	Merenda	D14/250
D672,386	S	*	12/2012	Matunuma et al.	D18/4.6
D678,870	S	*	3/2013	Fathollahi	D14/250
D698,772	S	*	2/2014	Merenda	D14/250
D703,650	S	*	4/2014	Ehrlich	D14/250
D716,285	S	*	10/2014	Chaney et al.	D14/250
D719,950	S	*	12/2014	Smith et al.	D14/250
D725,643	S	*	3/2015	Lee et al.	D14/250
D733,112	S	*	6/2015	Chaney et al.	D14/250
2013/0237290	A1	*	9/2013	Simmons et al.	455/569.1

* cited by examiner

Primary Examiner — Carla Jobe Wright

Assistant Examiner — Holly E Thurman

(74) *Attorney, Agent, or Firm* — Hornkohl Intellectual Property Law, PLLC; Jason L. Hornkohl

(57) **CLAIM**

The ornamental design for an electronic device case, as shown and described.

DESCRIPTION

FIG. 1 is a front isometric view of an electronic device case showing our new design;
FIG. 2 is a back isometric view thereof;
FIG. 3 is another back isometric view thereof;
FIG. 4 is a right side view thereof;
FIG. 5 is a front view thereof;
FIG. 6 is a left side view thereof;
FIG. 7 is a back view thereof;
FIG. 8 is a top view thereof; and,
FIG. 9 is a bottom view thereof.

The broken lines in the drawing figures depict unclaimed subject matter only and form no part of the claimed design.

1 Claim, 7 Drawing Sheets

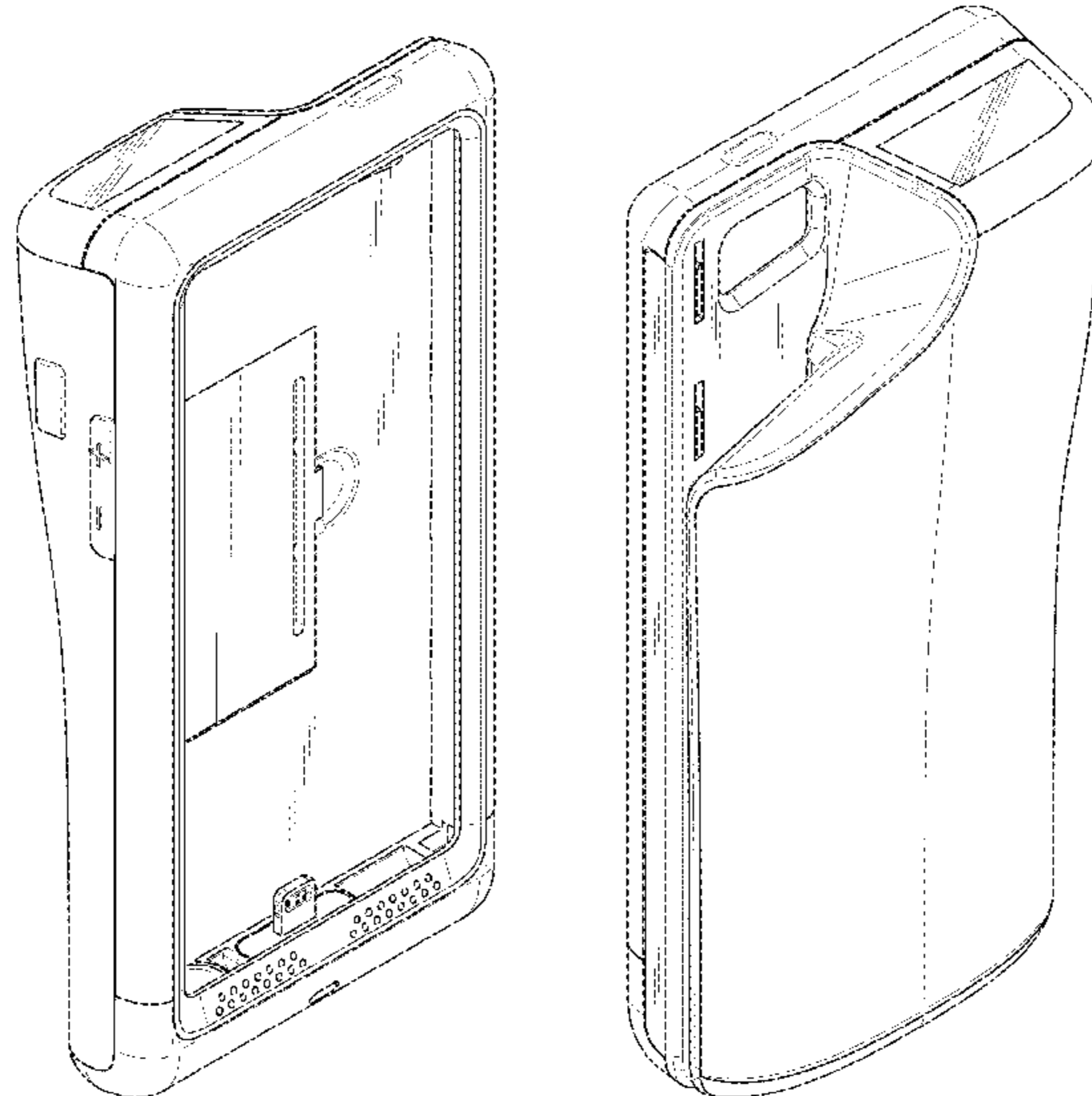

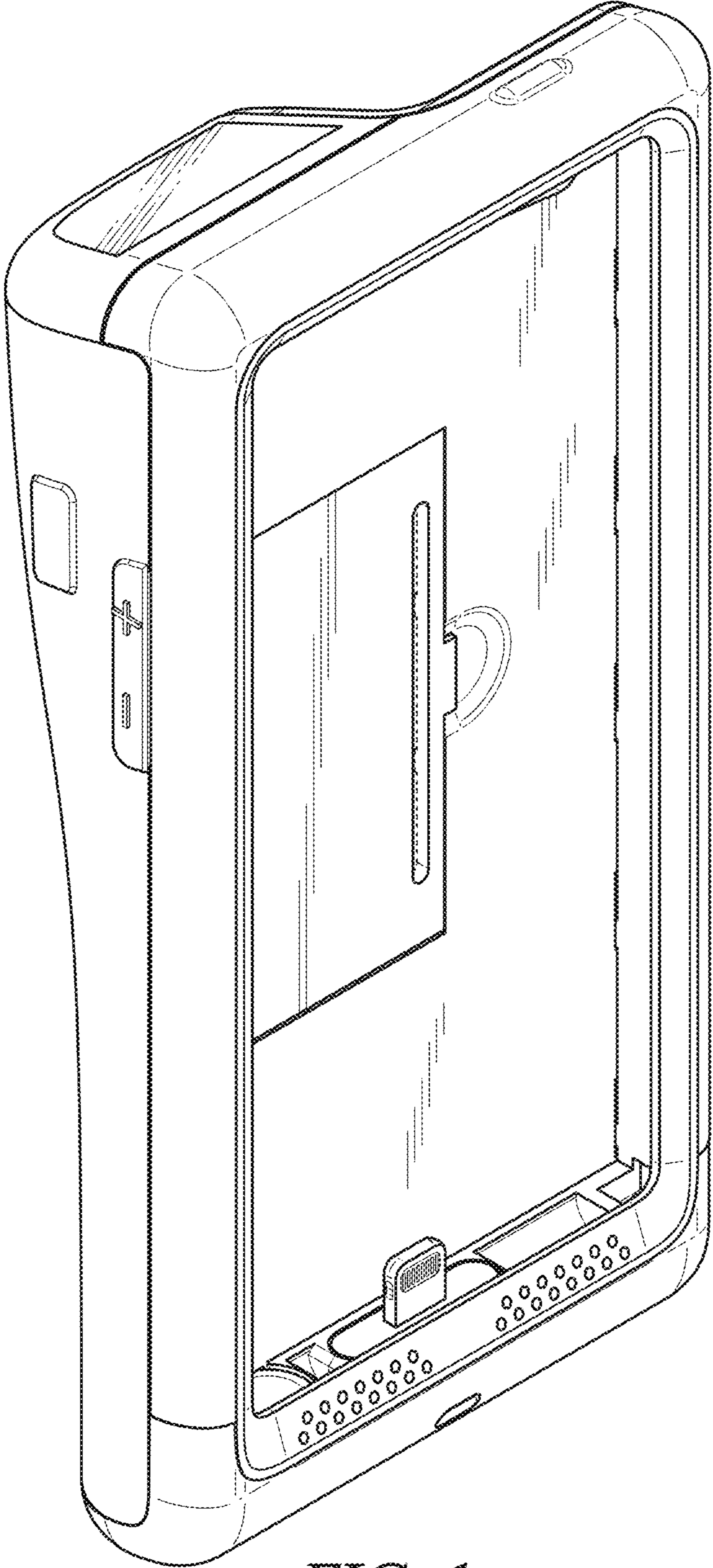

FIG. 1

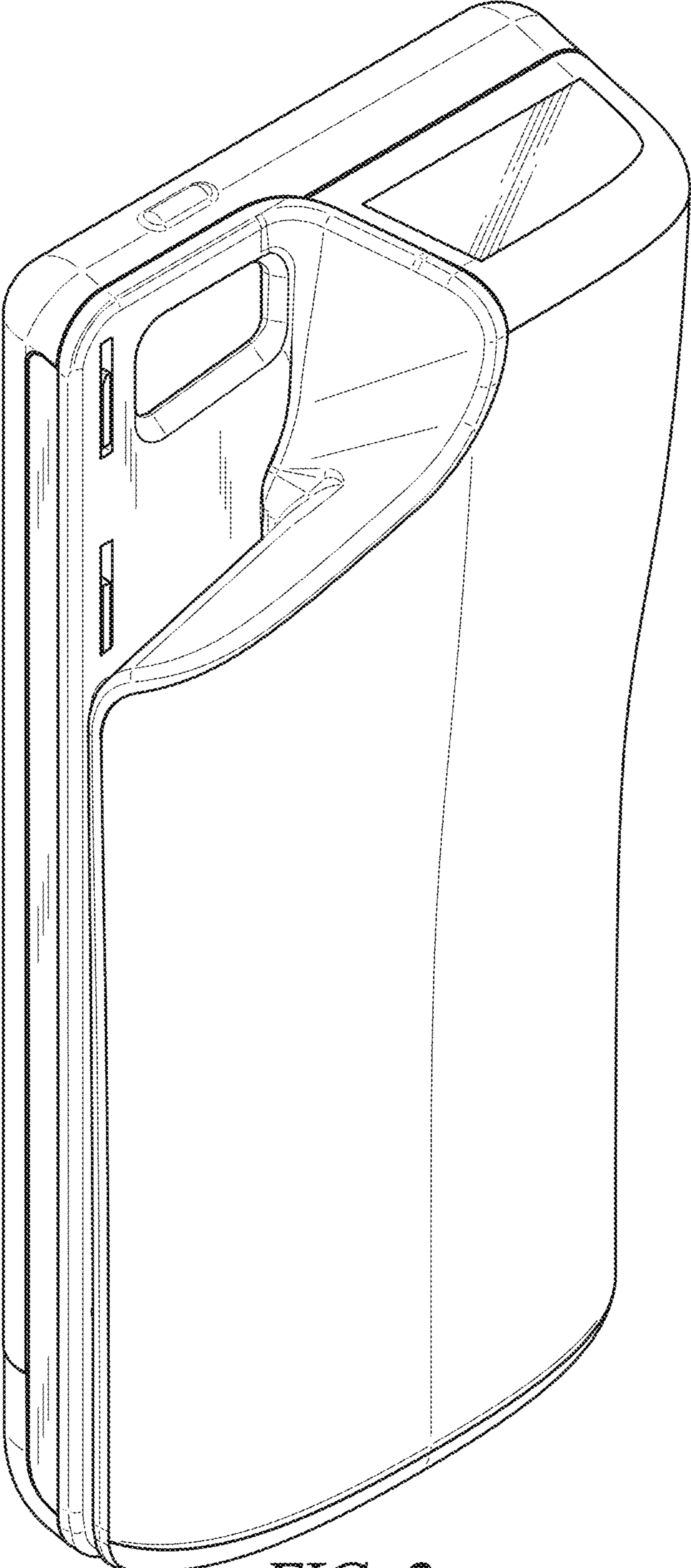

FIG. 2

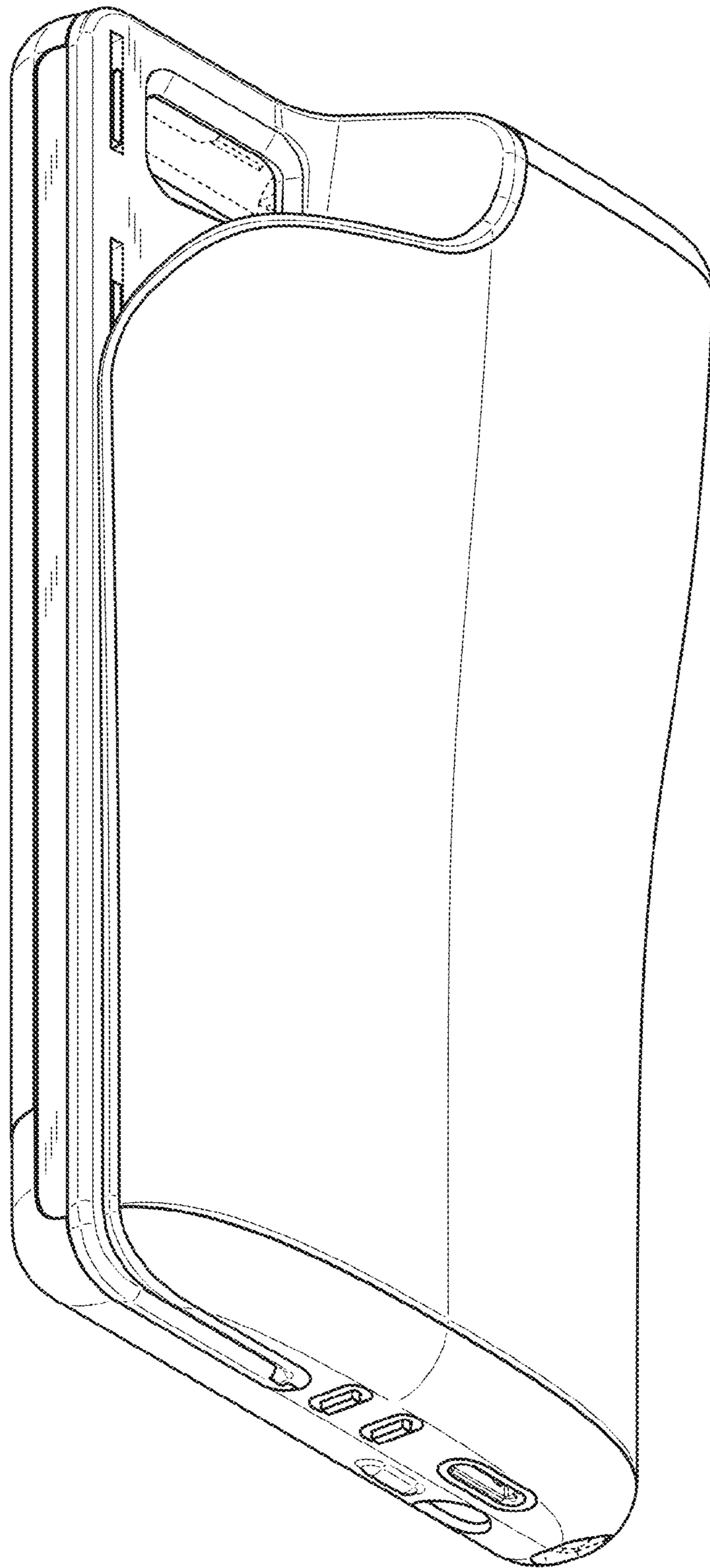

FIG. 3

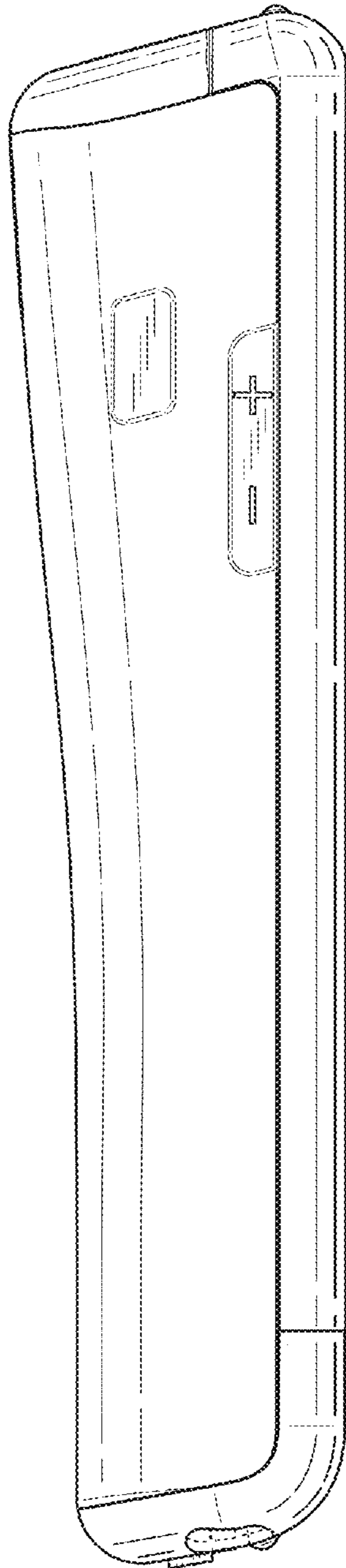

FIG. 4

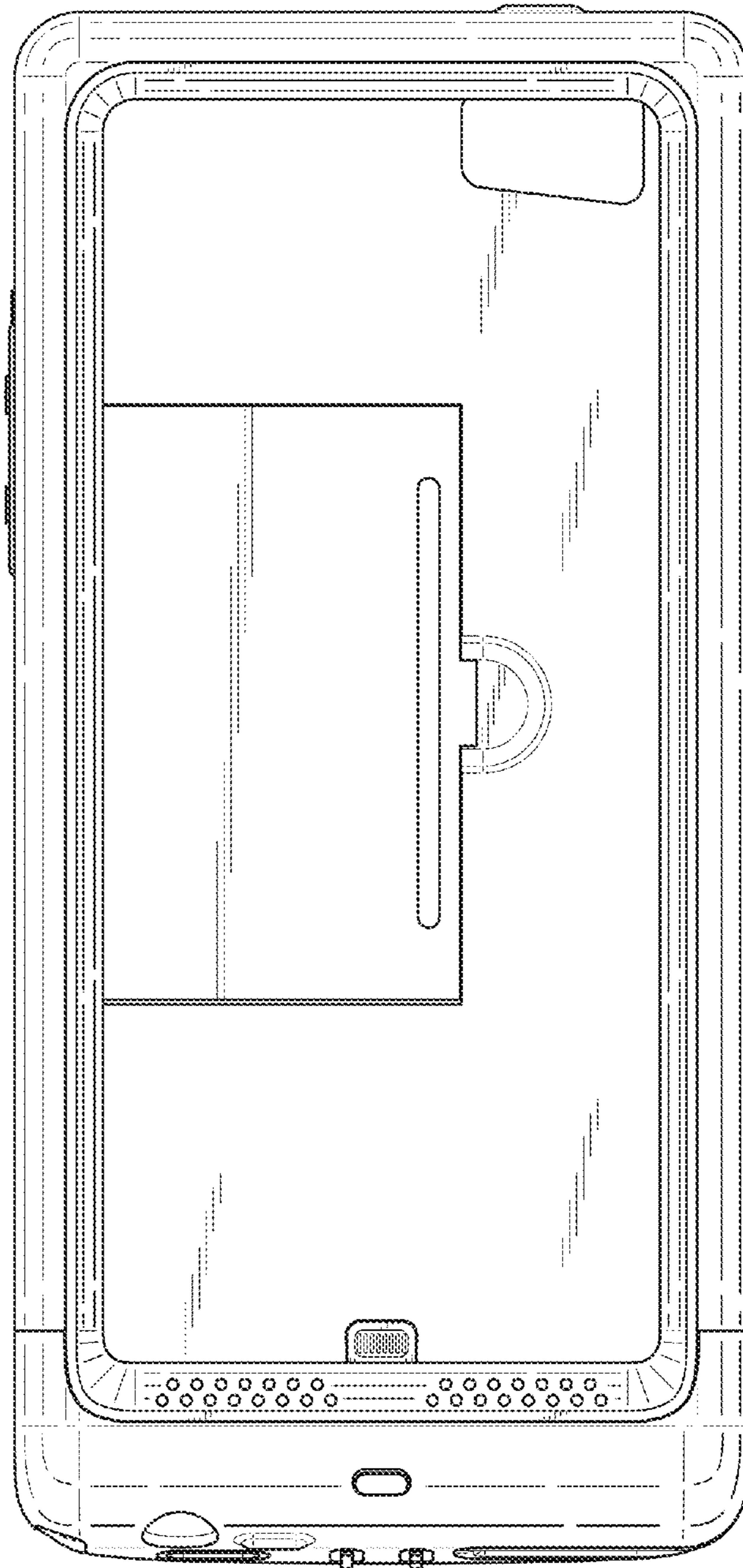

FIG. 5

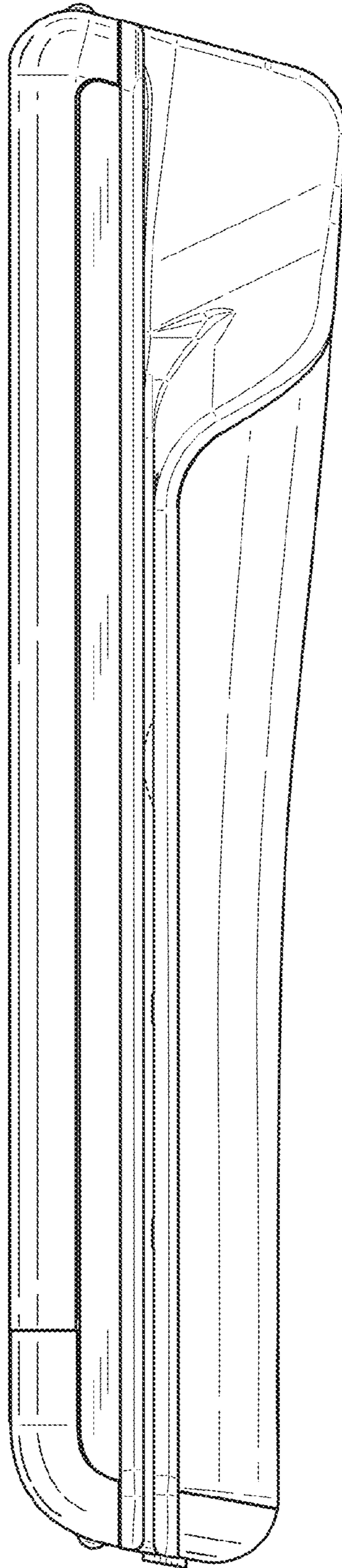

FIG. 6

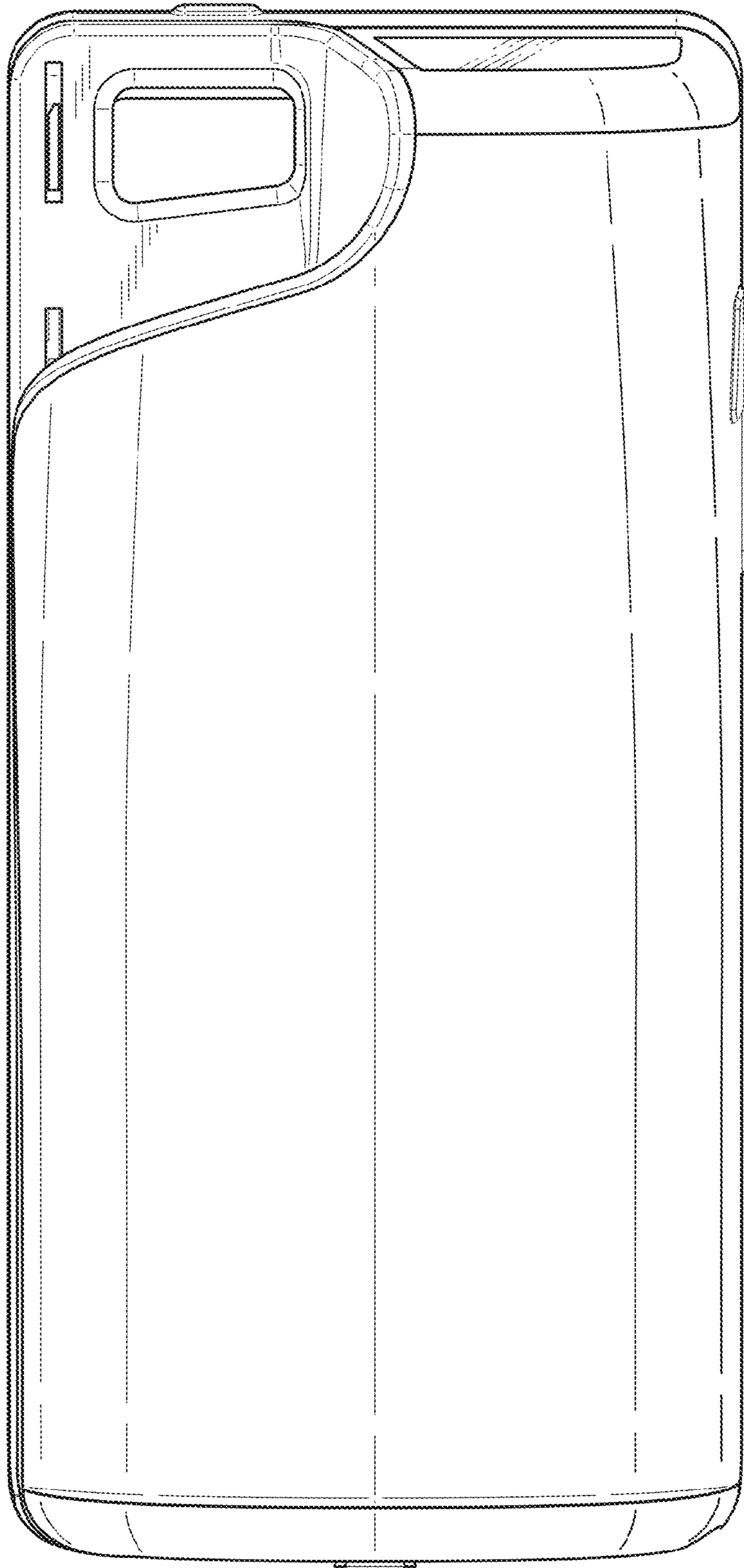

FIG. 7

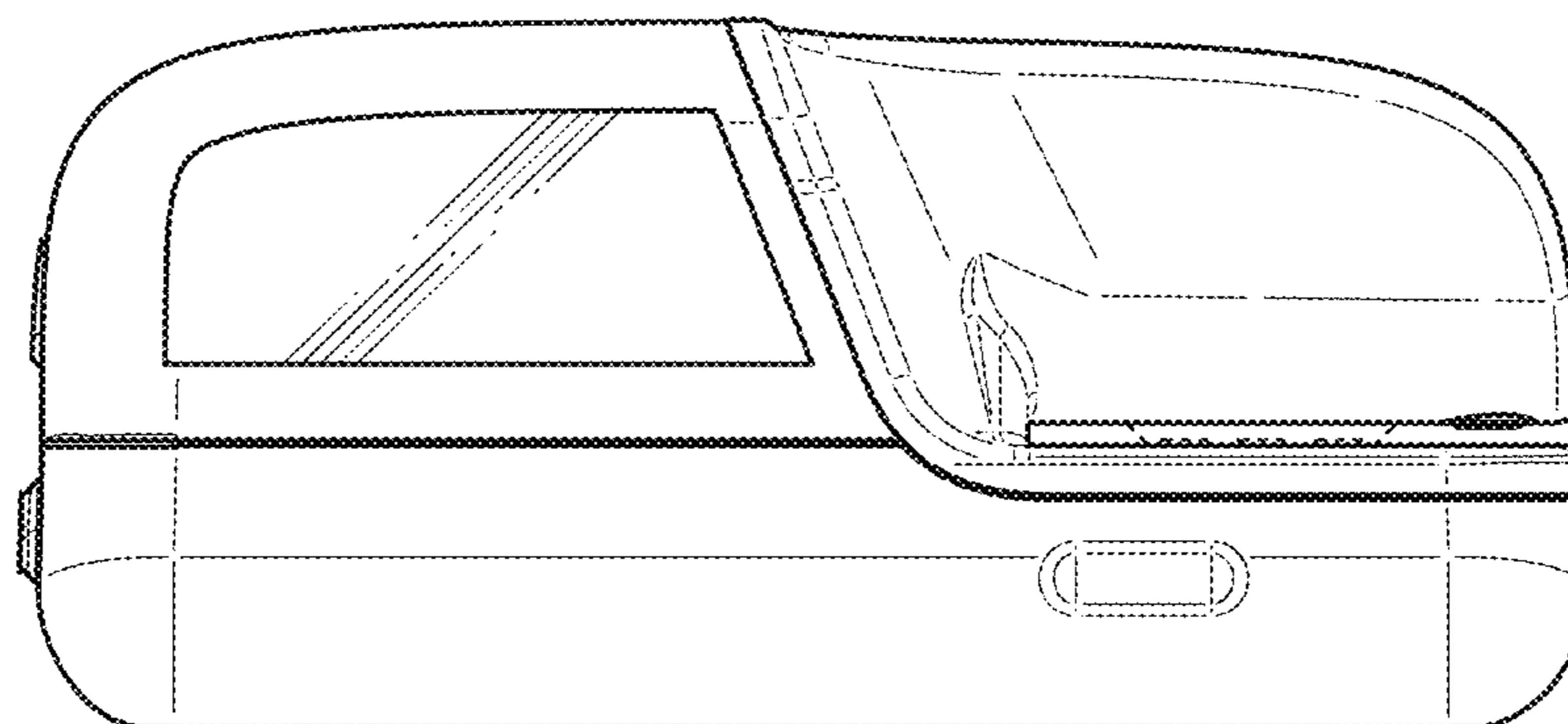

FIG. 8

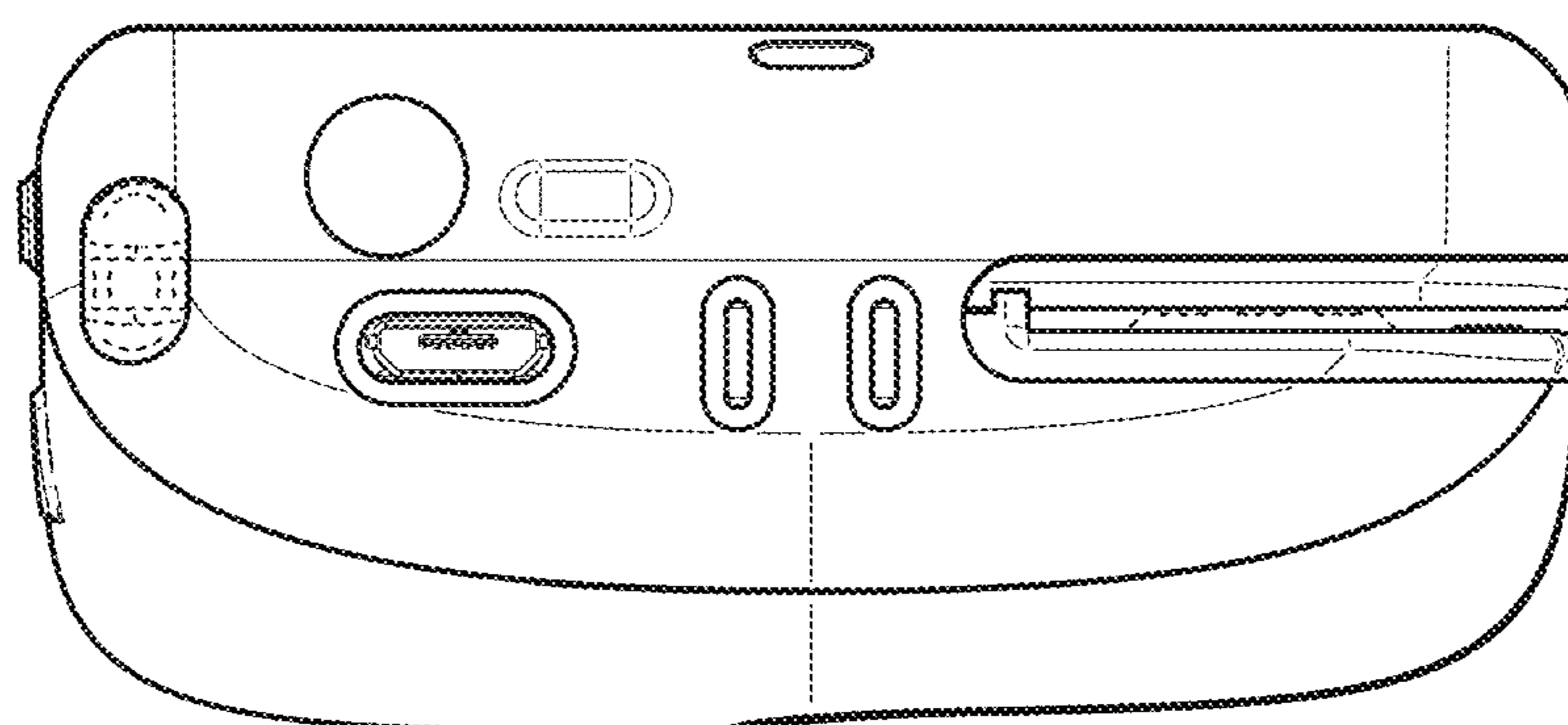

FIG. 9