



US00D754110S

(12) **United States Design Patent**  
**Jung et al.**

(10) **Patent No.:** **US D754,110 S**  
(45) **Date of Patent:** **\*\* Apr. 19, 2016**

(54) **GATEWAY FOR HOME NETWORK**

(71) Applicant: **Samsung Electronics Co., Ltd.**,  
Suwon-si, Gyeonggi-do (KR)

(72) Inventors: **Youngbin Jung**, Seoul (KR); **Junghyun Shim**, Yongin-si (KR); **Dongbin Tobin Cho**, Sungnam-si (KR); **Seunghwan Choi**, Ujungbu-si (KR)

(73) Assignee: **SAMSUNG ELECTRONICS CO., LTD.** (KR)

(\*\*) Term: **14 Years**

(21) Appl. No.: **29/499,266**

(22) Filed: **Aug. 13, 2014**

(30) **Foreign Application Priority Data**

Feb. 13, 2014 (KR) ..... 30-2014-0007379

(51) **LOC (10) Cl.** ..... **14-03**

(52) **U.S. Cl.**  
USPC ..... **D14/240**

(58) **Field of Classification Search**  
USPC ..... D14/240, 242, 125, 239, 357, 358,  
D14/140-140.9, 155, 137, 139, 243, 433  
CPC ..... H04L 12/00; H03K 17/00; H04W 88/00;  
H04W 88/005; H04W 88/02; H04W 88/08;  
H04W 88/085; H04W 88/10; H04W 88/12;  
H04W 88/14; H04B 1/38

See application file for complete search history.

(56) **References Cited**

U.S. PATENT DOCUMENTS

D544,463	S	*	6/2007	Harris	.....	D14/168
D577,713	S	*	9/2008	Kim et al.	.....	D14/218
D609,221	S	*	2/2010	Kim et al.	.....	D14/218
D624,541	S	*	9/2010	Kemery et al.	.....	D14/358
D706,249	S	*	6/2014	Holzer	.....	D14/240
D714,249	S	*	9/2014	Carney et al.	.....	D14/140
D723,480	S	*	3/2015	Lee et al.	.....	D14/125
D725,624	S	*	3/2015	Carney et al.	.....	D14/149

FOREIGN PATENT DOCUMENTS

JP D1443465 \* 5/2012

\* cited by examiner

*Primary Examiner* — Bridget L Eland

(74) *Attorney, Agent, or Firm* — Cantor Colburn LLP

(57) **CLAIM**

The ornamental design for a gateway for home network, as shown and described.

**DESCRIPTION**

FIG. 1 is the front perspective view of a gateway for home network showing our new design;  
FIG. 2 is the front view thereof;  
FIG. 3 is the rear view thereof;  
FIG. 4 is the left-side view thereof;  
FIG. 5 is the right-side view thereof;  
FIG. 6 is the top-side plan view thereof;  
FIG. 7 is the bottom-side plan view thereof; and,  
FIG. 8 is another front perspective view thereof, as shown in an alternate configuration.  
The broken lines are for environmental purposes only and form no part of the claimed design.

**1 Claim, 8 Drawing Sheets**

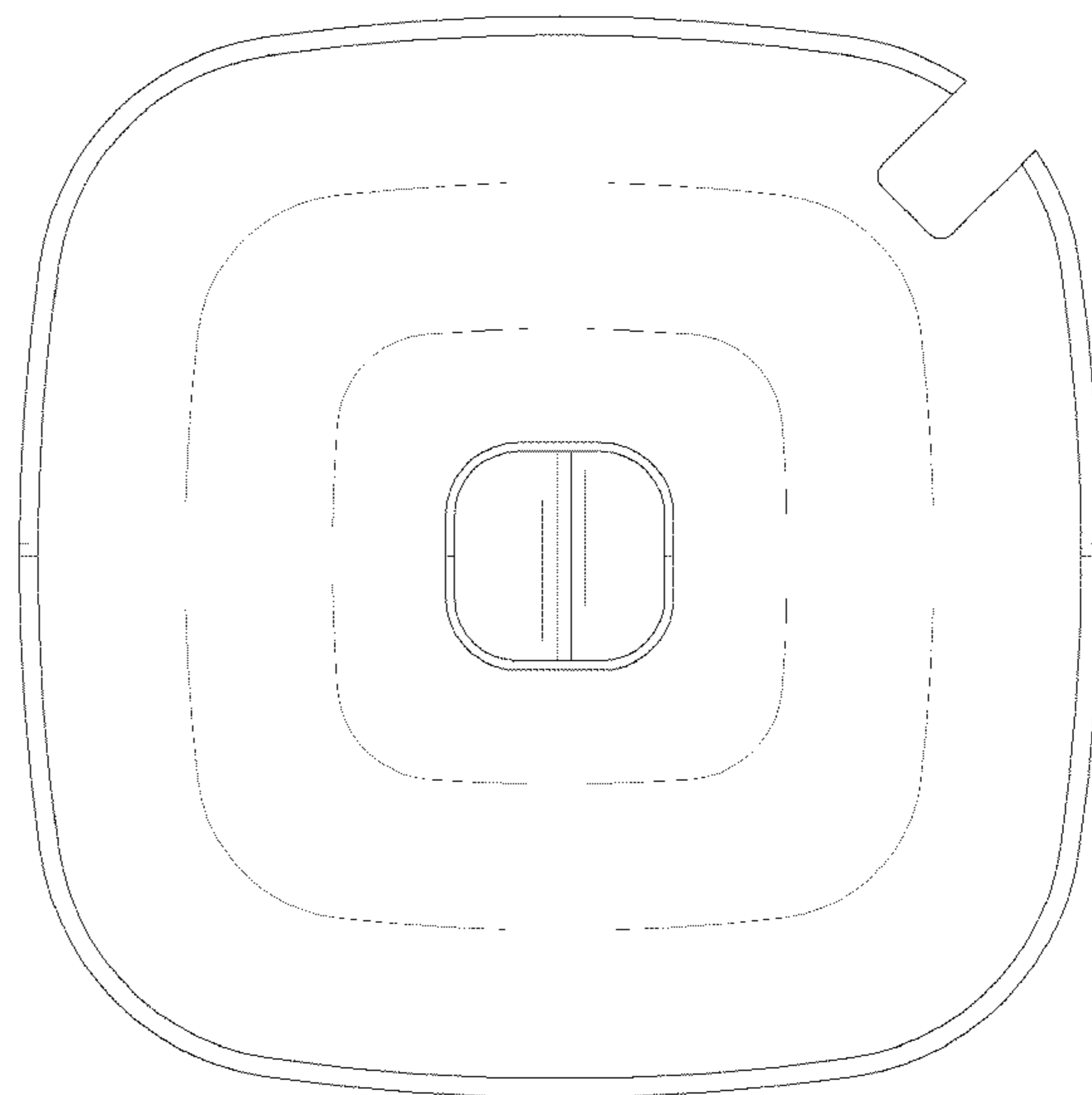
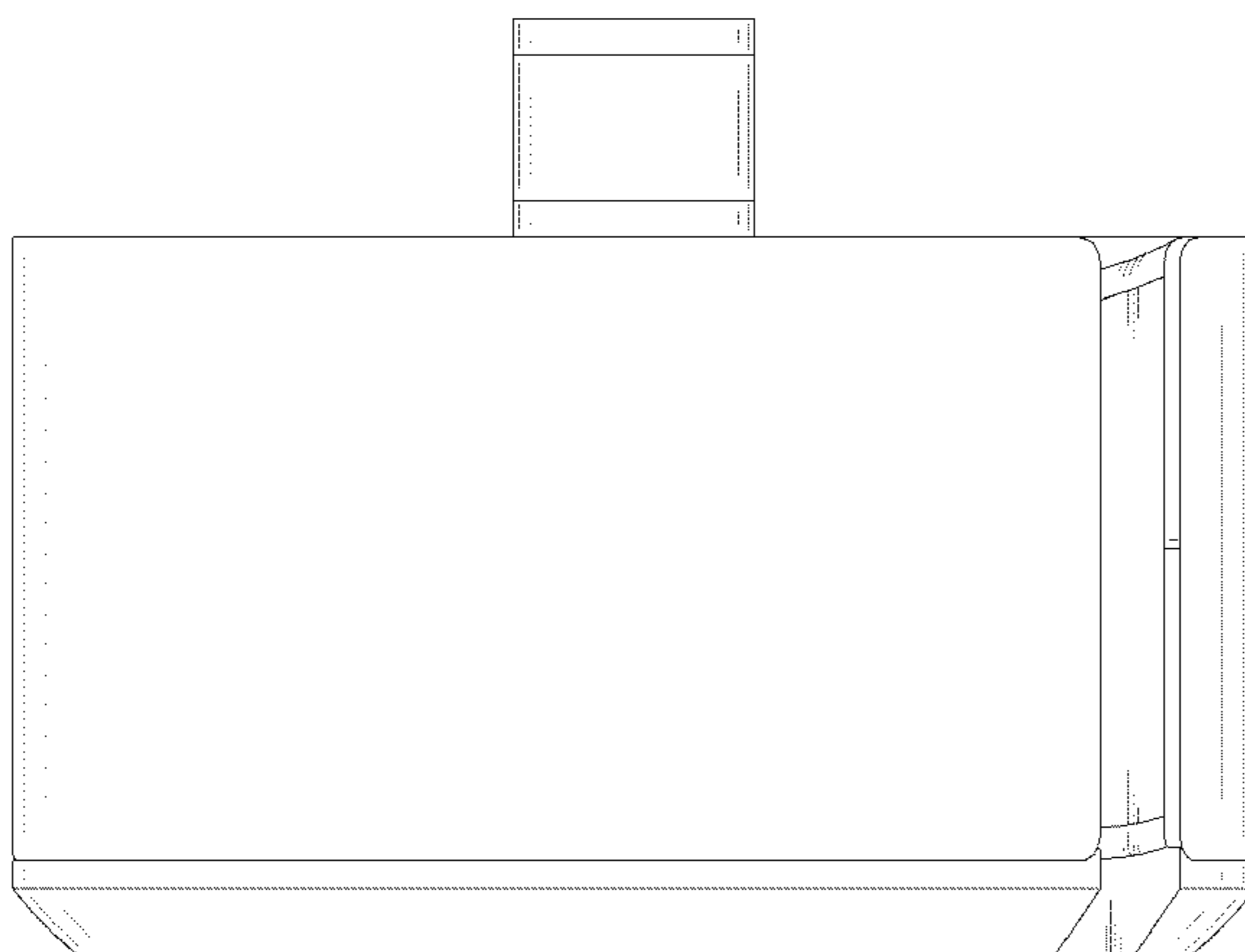
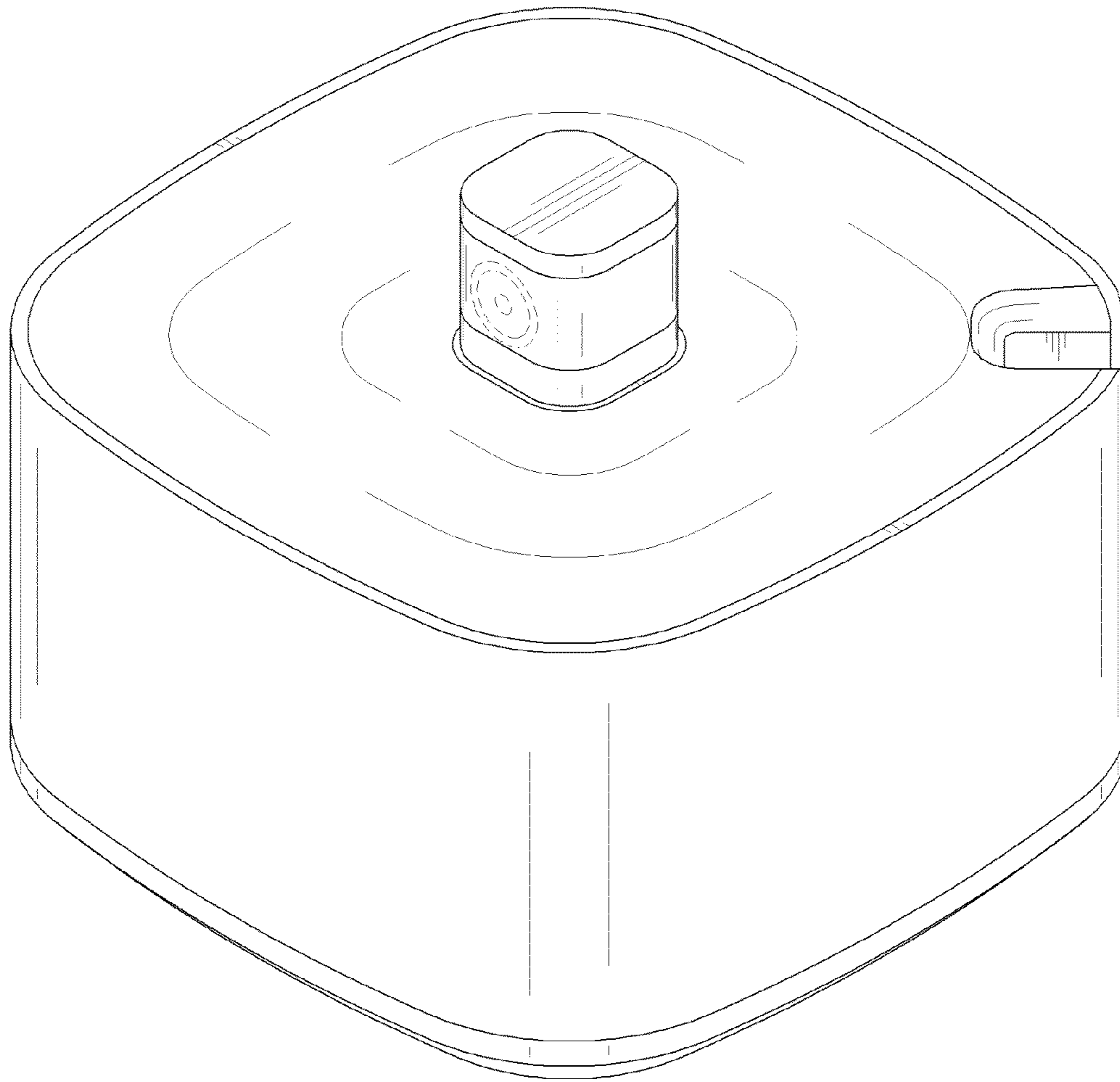

Fig. 1



**Fig. 2**

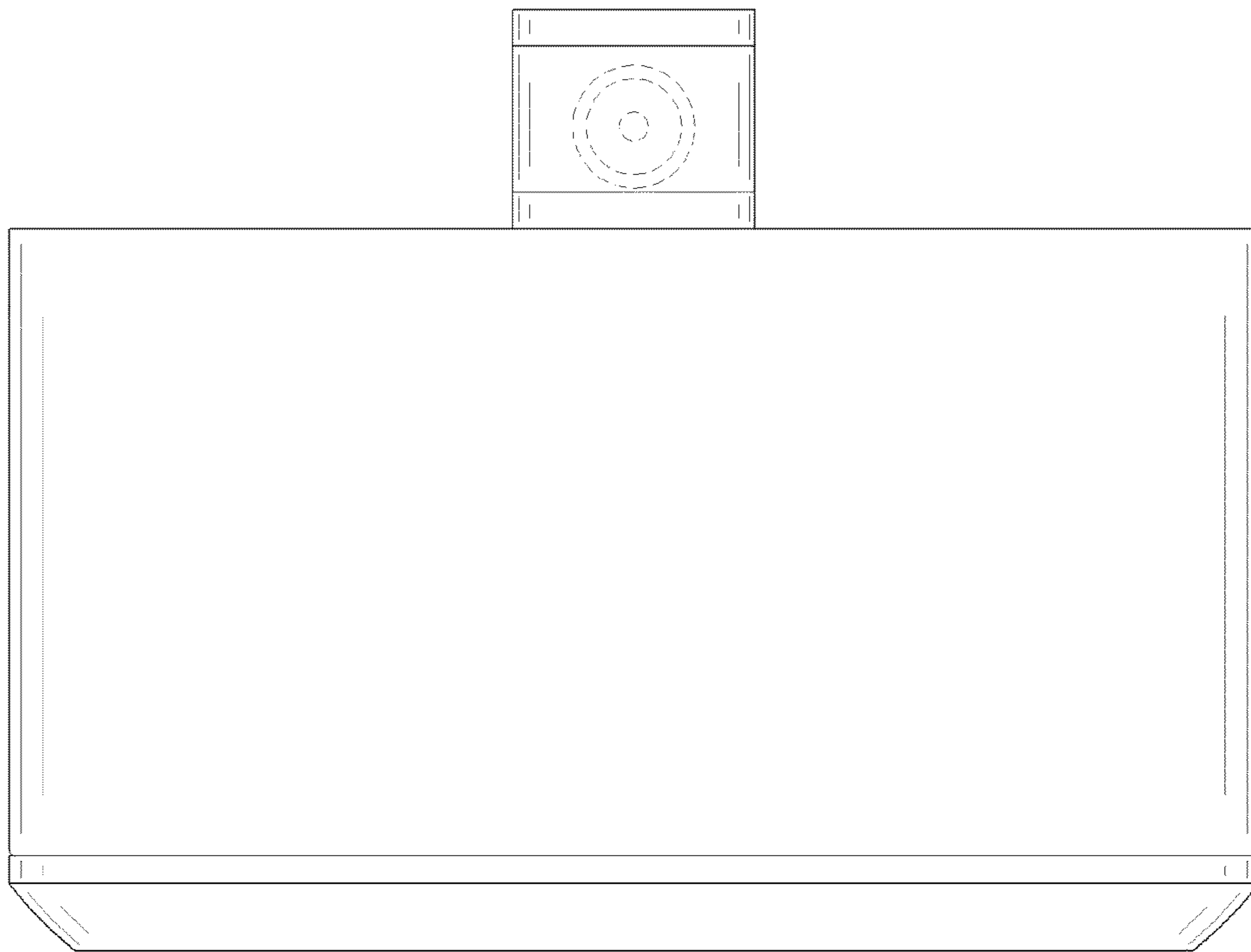

Fig. 3

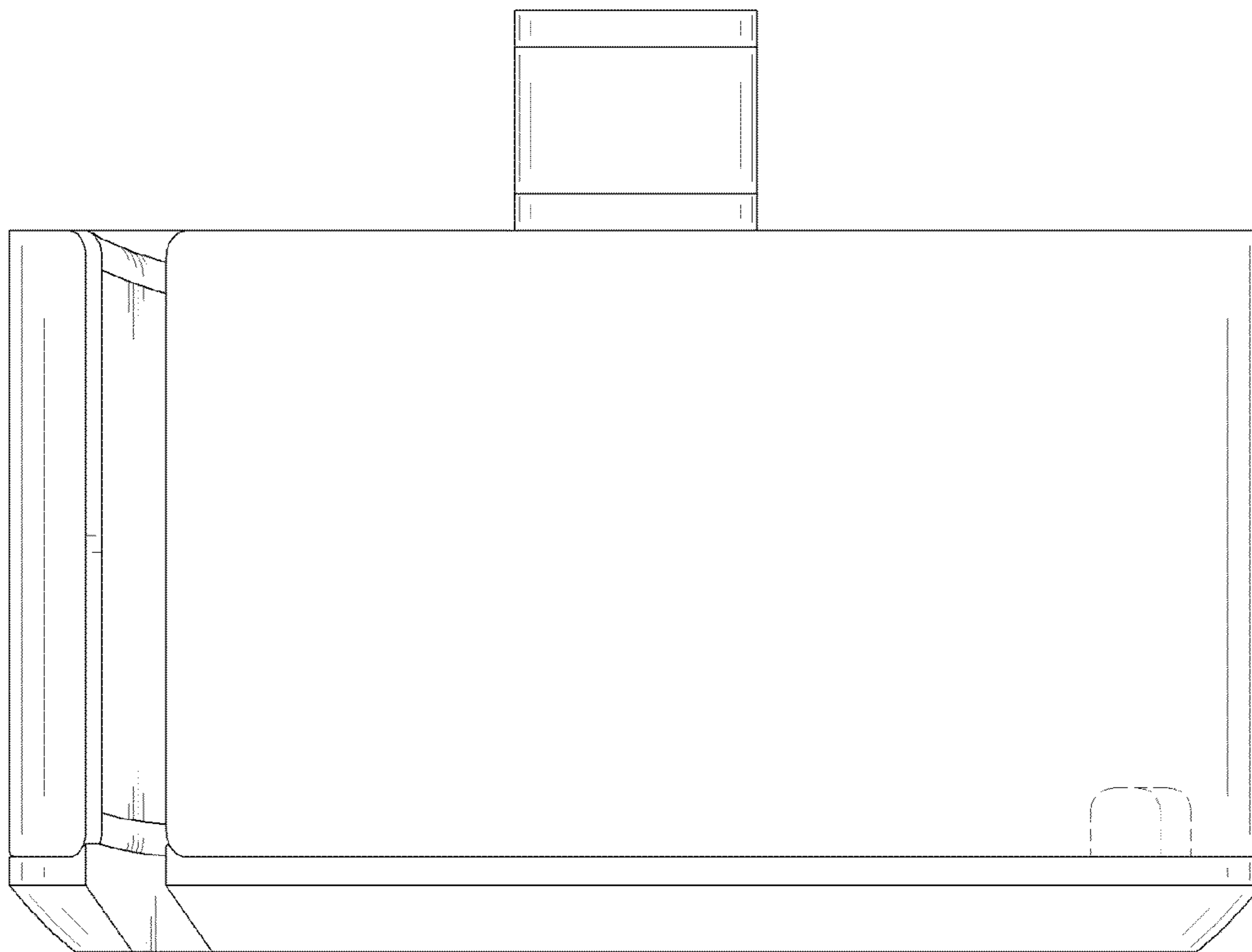
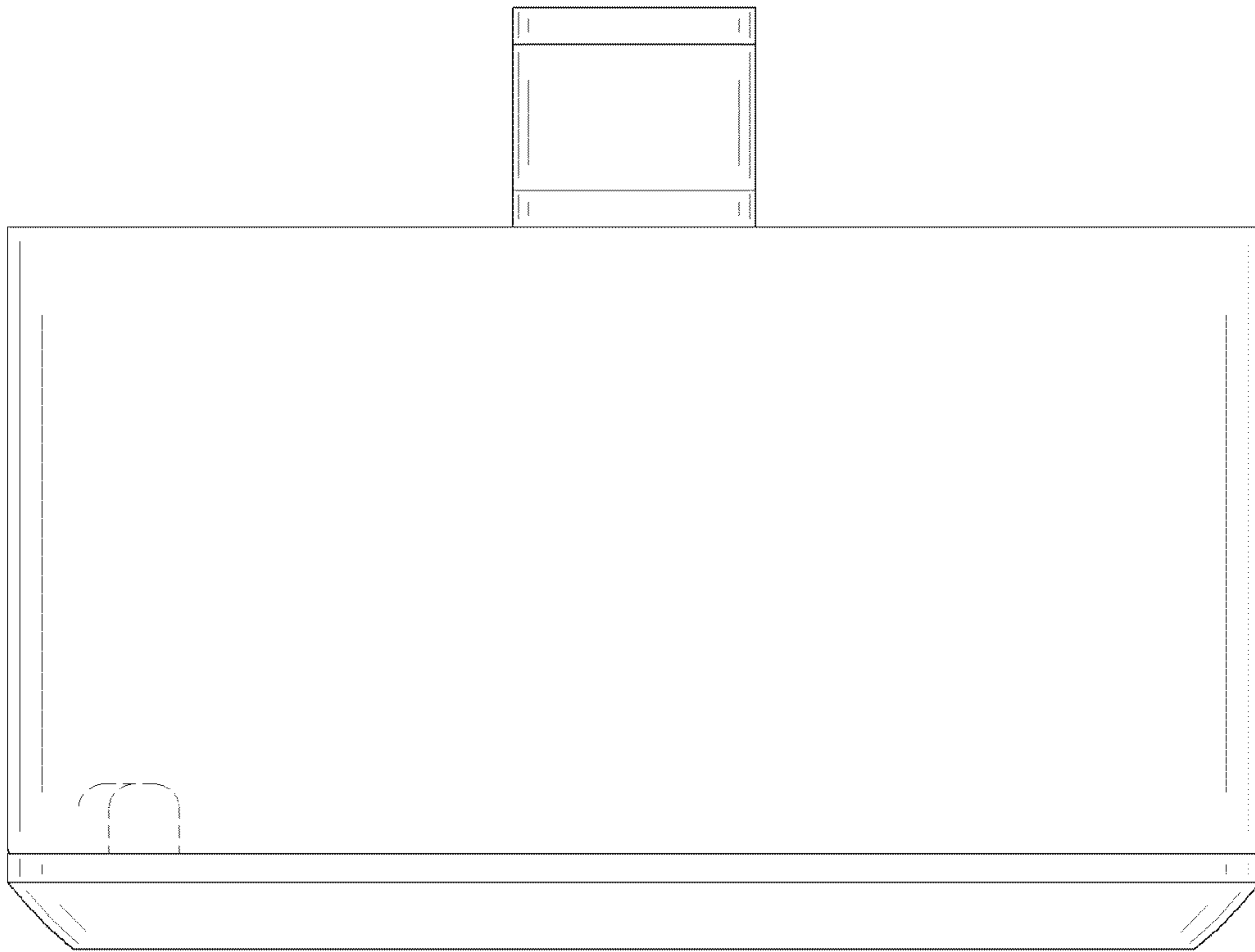

Fig. 4



**Fig. 5**

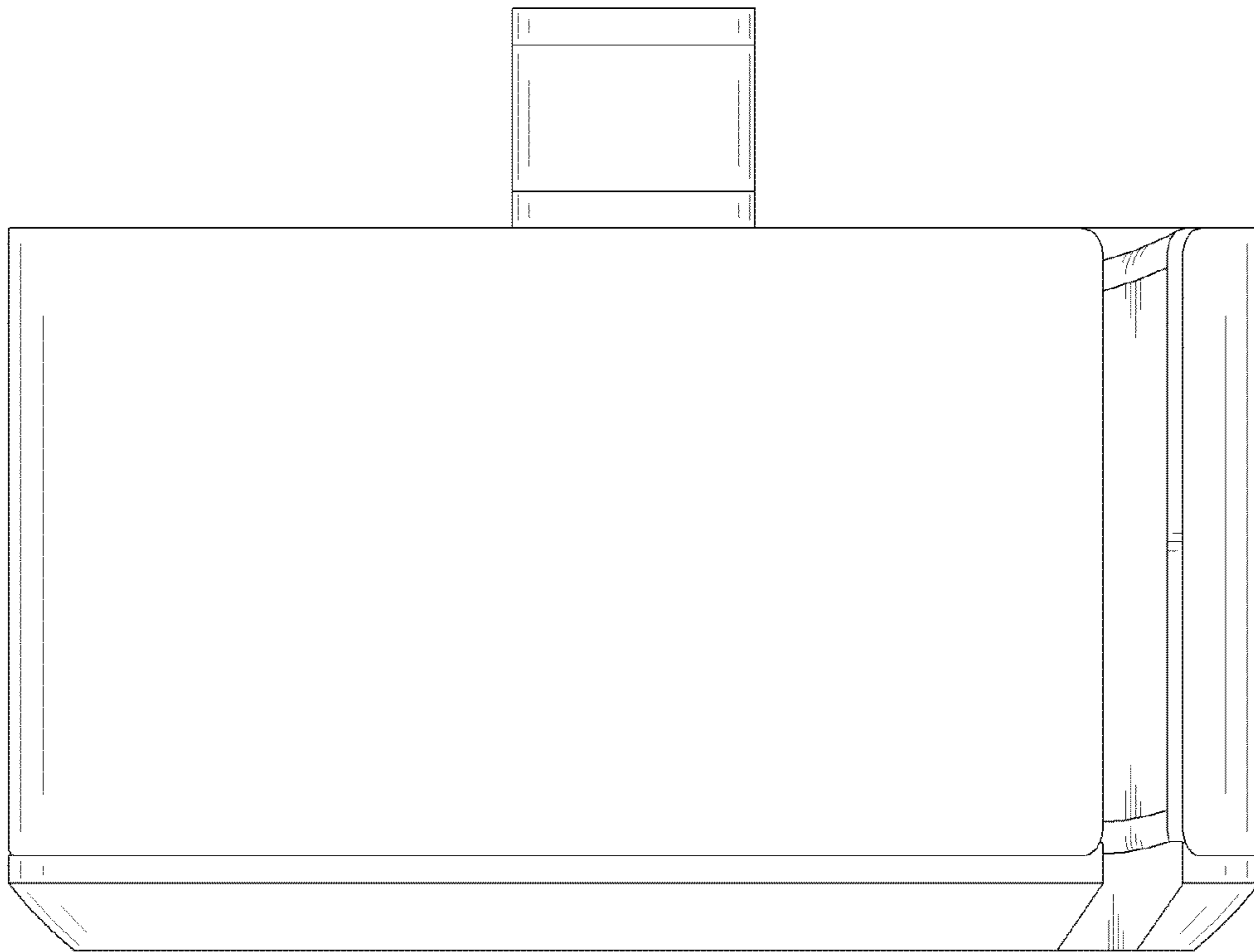

Fig. 6

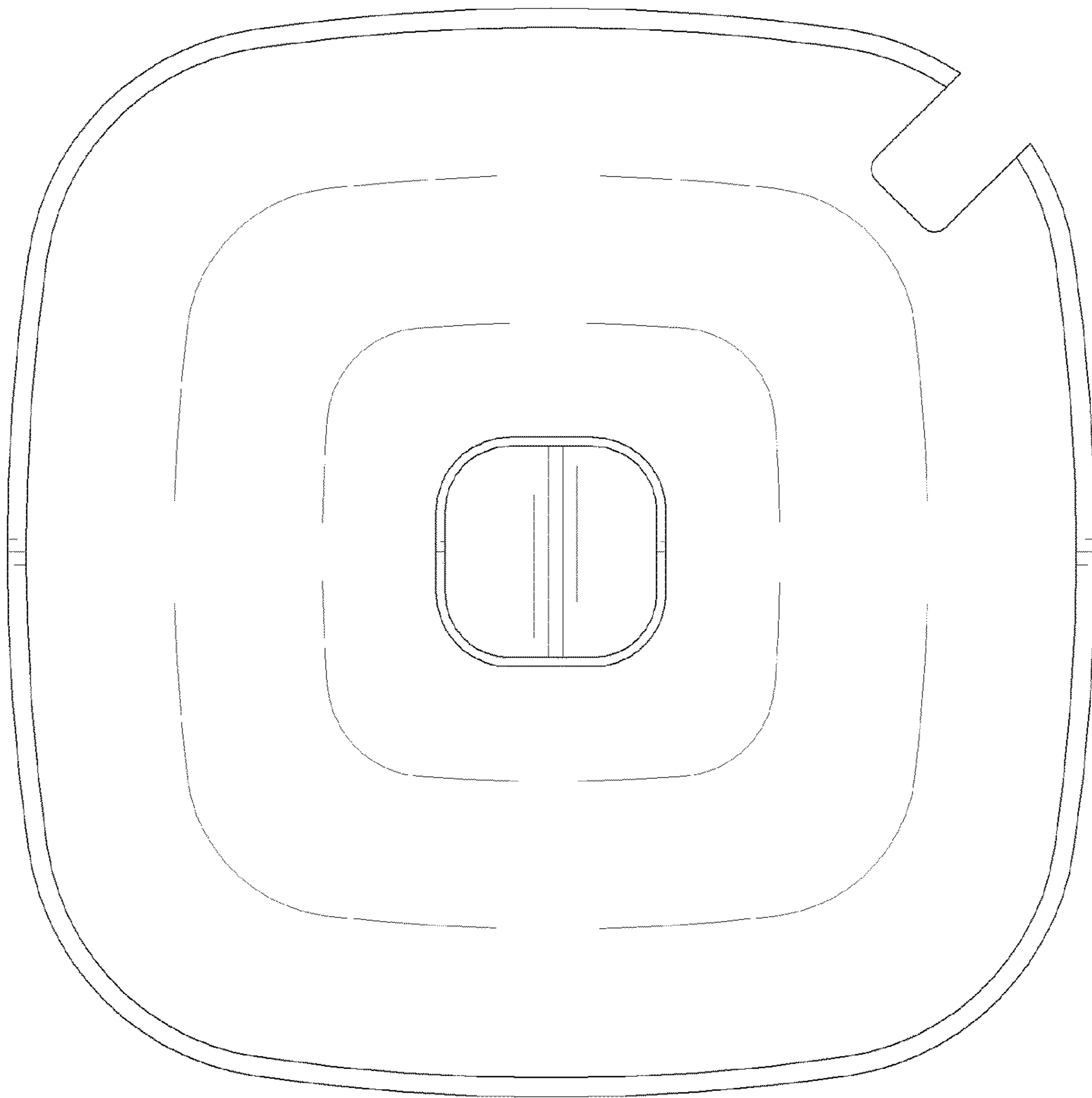

Fig. 7

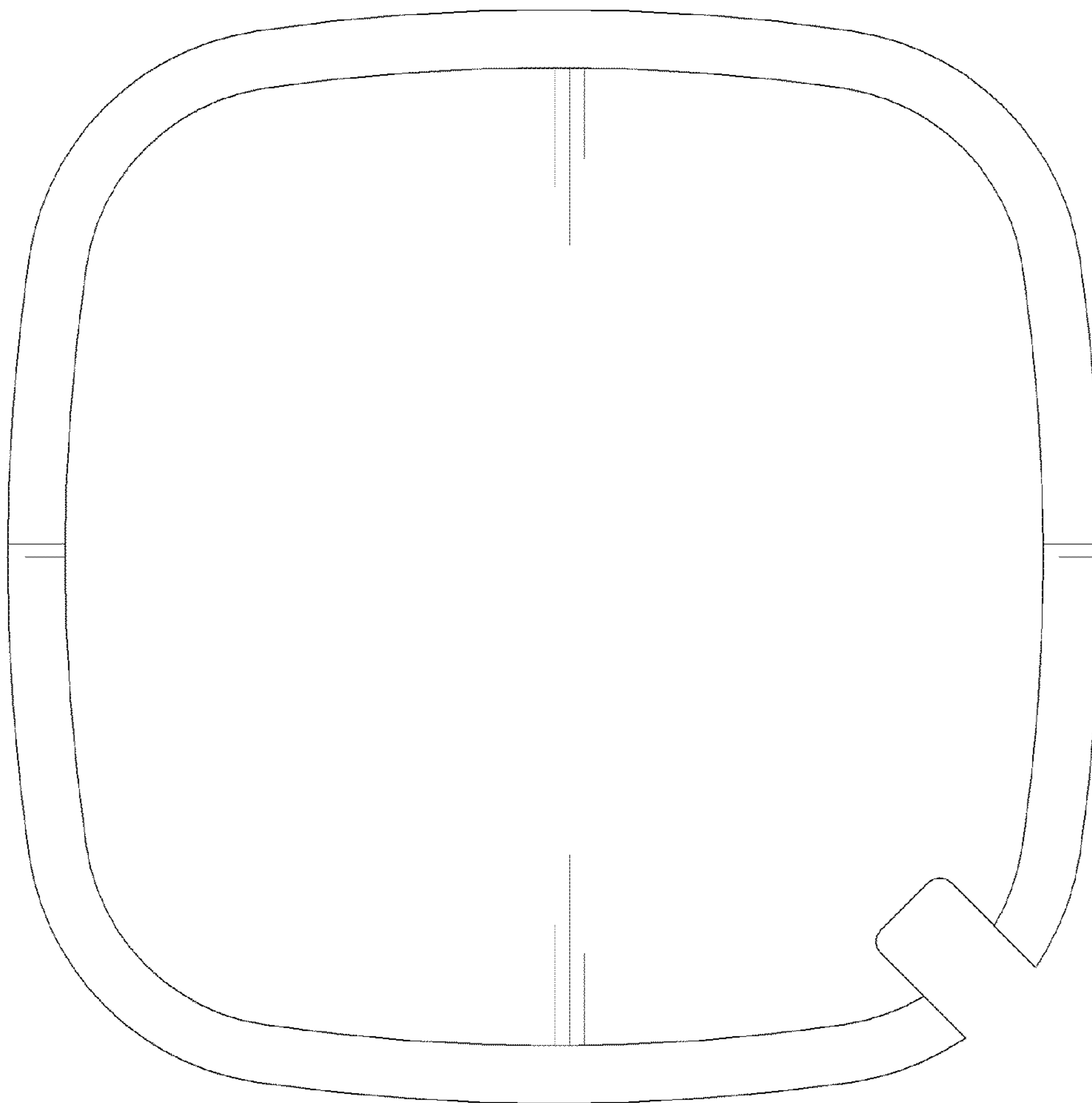



Fig. 8

