



US00D754086S

(12) **United States Design Patent**
Valeur

(10) **Patent No.:** **US D754,086 S**
(45) **Date of Patent:** **** Apr. 19, 2016**

- (54) **TELEVISION WITH SLIDING SPEAKERS**
- (71) Applicant: **BANG & OLUFSEN A/S**, Struer (DK)
- (72) Inventor: **Torsten Valeur**, København V (DK)
- (73) Assignee: **BANG & OLUFSEN A/S**, Struer (DK)
- (**) Term: **14 Years**
- (21) Appl. No.: **29/503,245**
- (22) Filed: **Sep. 24, 2014**

- (30) **Foreign Application Priority Data**
Mar. 24, 2014 (DK) DA 2014 00030
- (51) **LOC (10) Cl.** **14-03**
- (52) **U.S. Cl.**
USPC **D14/126**
- (58) **Field of Classification Search**
USPC D14/125–134, 239, 371, 136, 374–377,
D14/440, 450, 448, 336, 342, 159; 312/7.2;
348/836, 838, 180, 184, 325, 739;
248/917–924, 465; 345/104, 133, 156,
345/168, 87, 173; D21/329, 515, 577, 622,
D21/333, 433, 448, 452, 450, 331, 505;
D10/15, 26; 446/484, 175, 356;
D6/477, 479, 300; D20/10, 19, 39
CPC ... G06F 1/1601; G06F 1/1643; H05K 5/0004;
H05K 5/0017; H05K 5/02; H05K 5/0217;
H04N 13/0459
See application file for complete search history.

- (56) **References Cited**
U.S. PATENT DOCUMENTS
D534,878 S 1/2007 Ellison
D564,994 S * 3/2008 Yamaguchi D14/126
(Continued)

Primary Examiner — Raphael Barkai
(74) *Attorney, Agent, or Firm* — Dykema Gossett PLLC

(57) **CLAIM**
The ornamental design for a television with sliding speakers, as shown and described.

DESCRIPTION

FIG. 1 is a first front, side, and top perspective view of a television with sliding speakers in a first position showing my design;

FIG. 2 is a first rear, side, and top perspective view of FIG. 1;

FIG. 3 is a first front elevation view of FIG. 1;

FIG. 4 is a first rear elevation view of FIG. 1;

FIG. 5 is a first right side elevation view of FIG. 1, wherein a first left side elevation view is a mirror image thereof;

FIG. 6 is a first top plan view of FIG. 1;

FIG. 7 is a first bottom plan view of FIG. 1;

FIG. 8 is a second front, side, and top perspective view;

FIG. 9 is a second rear, side, and top perspective view;

FIG. 10 is a second front elevation view;

FIG. 11 is a second rear elevation view;

FIG. 12 is a second left side elevation view, wherein a second right side elevation view is a mirror image thereof;

FIG. 13 is a second top plan view;

FIG. 14 is a second bottom plan view;

FIG. 15 is a front, side, and top perspective view of FIG. 1 in a second position;

FIG. 16 is a rear, side, and top perspective view of FIG. 15;

FIG. 17 is a front elevation view of FIG. 15;

FIG. 18 is a rear elevation view of FIG. 15;

FIG. 19 is a left side elevation view of FIG. 15, wherein a right side elevation view is a mirror image thereof;

FIG. 20 is a top plan view of FIG. 15; and,

FIG. 21 is a bottom plan view of FIG. 15.

1 Claim, 18 Drawing Sheets

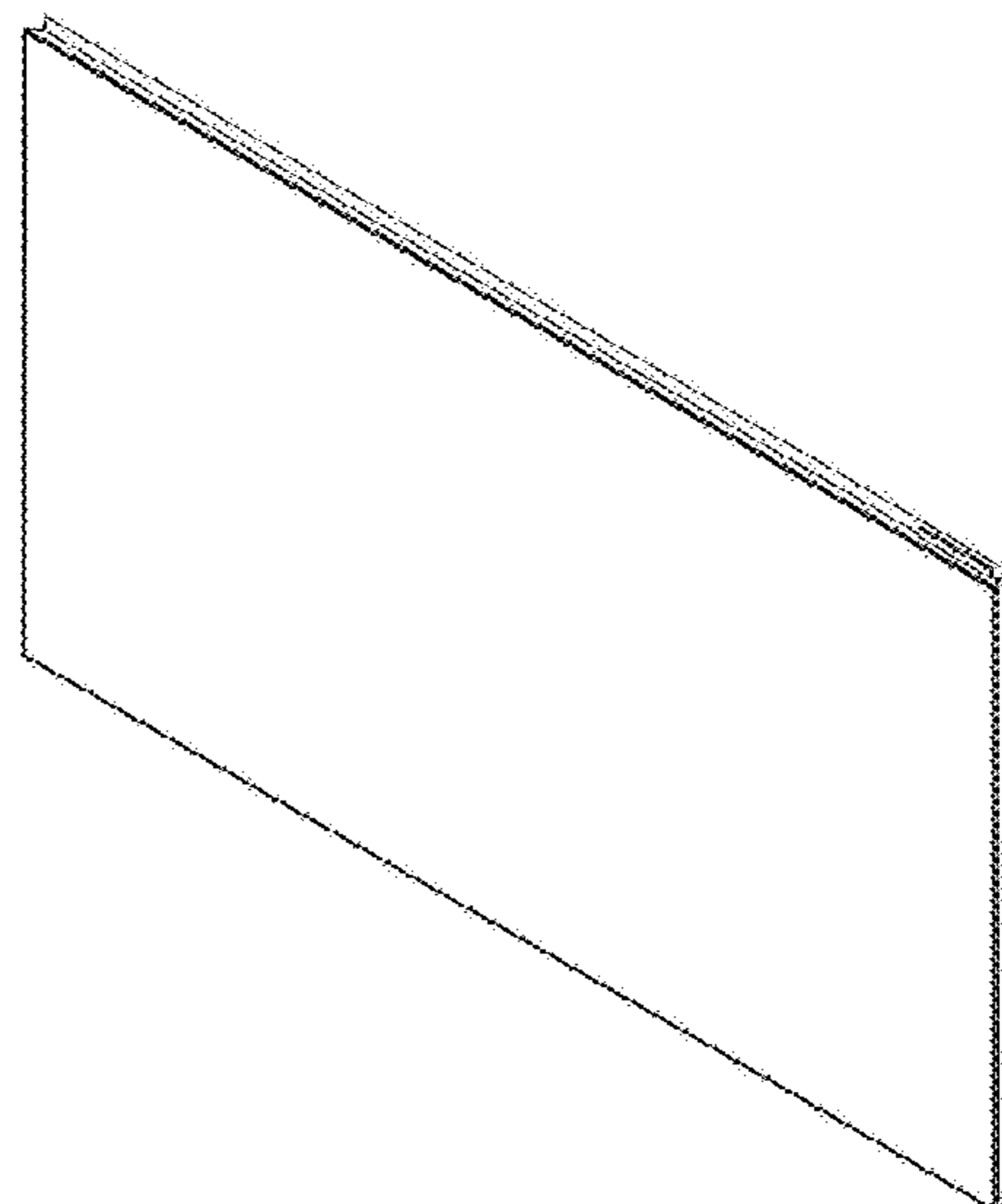
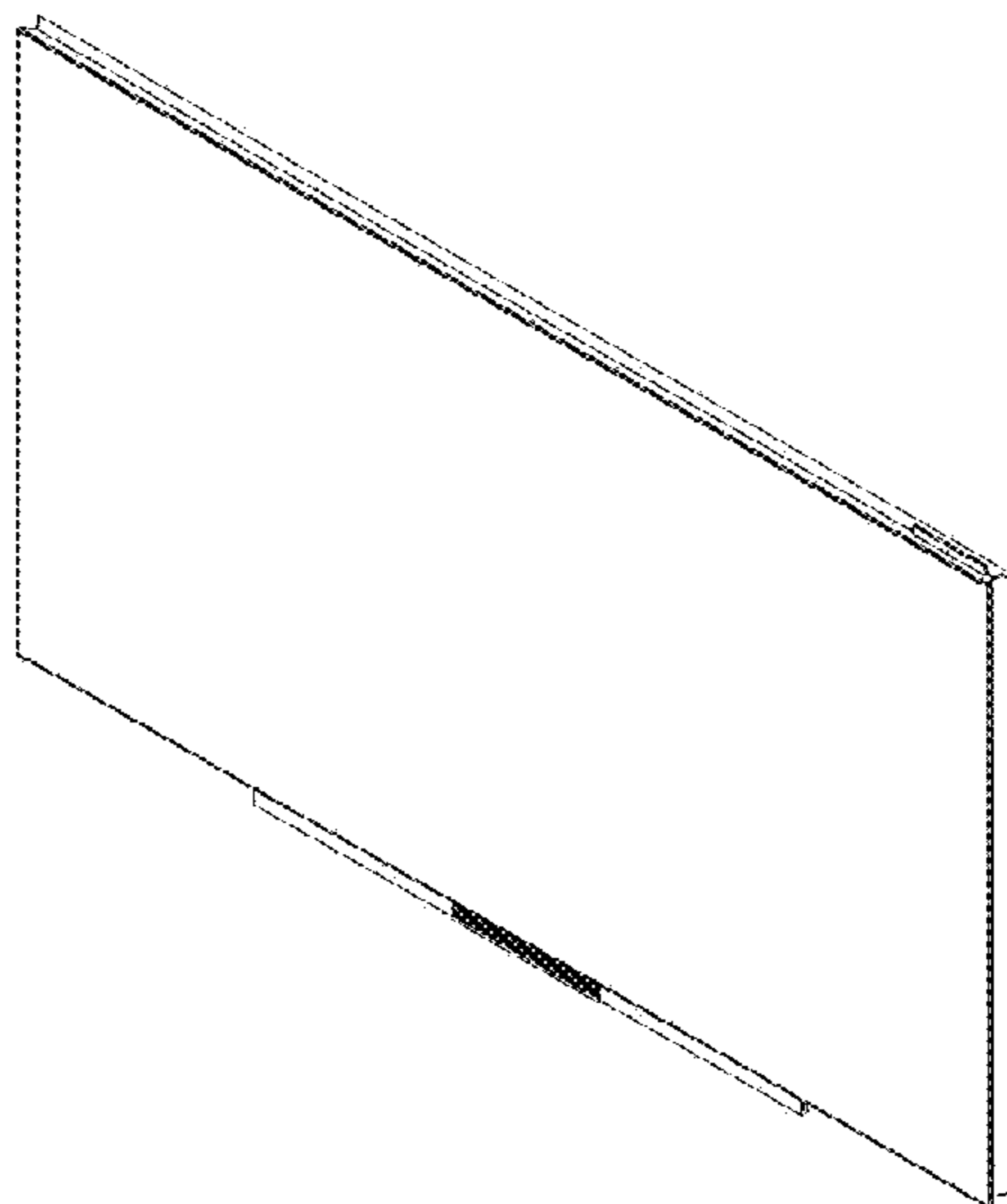

(56)

References Cited

U.S. PATENT DOCUMENTS

D572,678 S * 7/2008 Fujiki D14/126
D573,958 S * 7/2008 Shih D14/126
D585,854 S * 2/2009 Shih et al. D14/126
D588,082 S * 3/2009 Arai D14/126
D600,661 S 9/2009 Ohki et al.

D617,290 S 6/2010 Lewis
D620,905 S * 8/2010 Honda D14/126
D629,372 S * 12/2010 Lim et al. D14/126
D640,998 S * 7/2011 Takami et al. D14/126
D646,242 S * 10/2011 Honda D14/126
D650,765 S * 12/2011 Ho D14/126
D692,403 S 10/2013 Takami et al.
D695,243 S 12/2013 Lewis

* cited by examiner

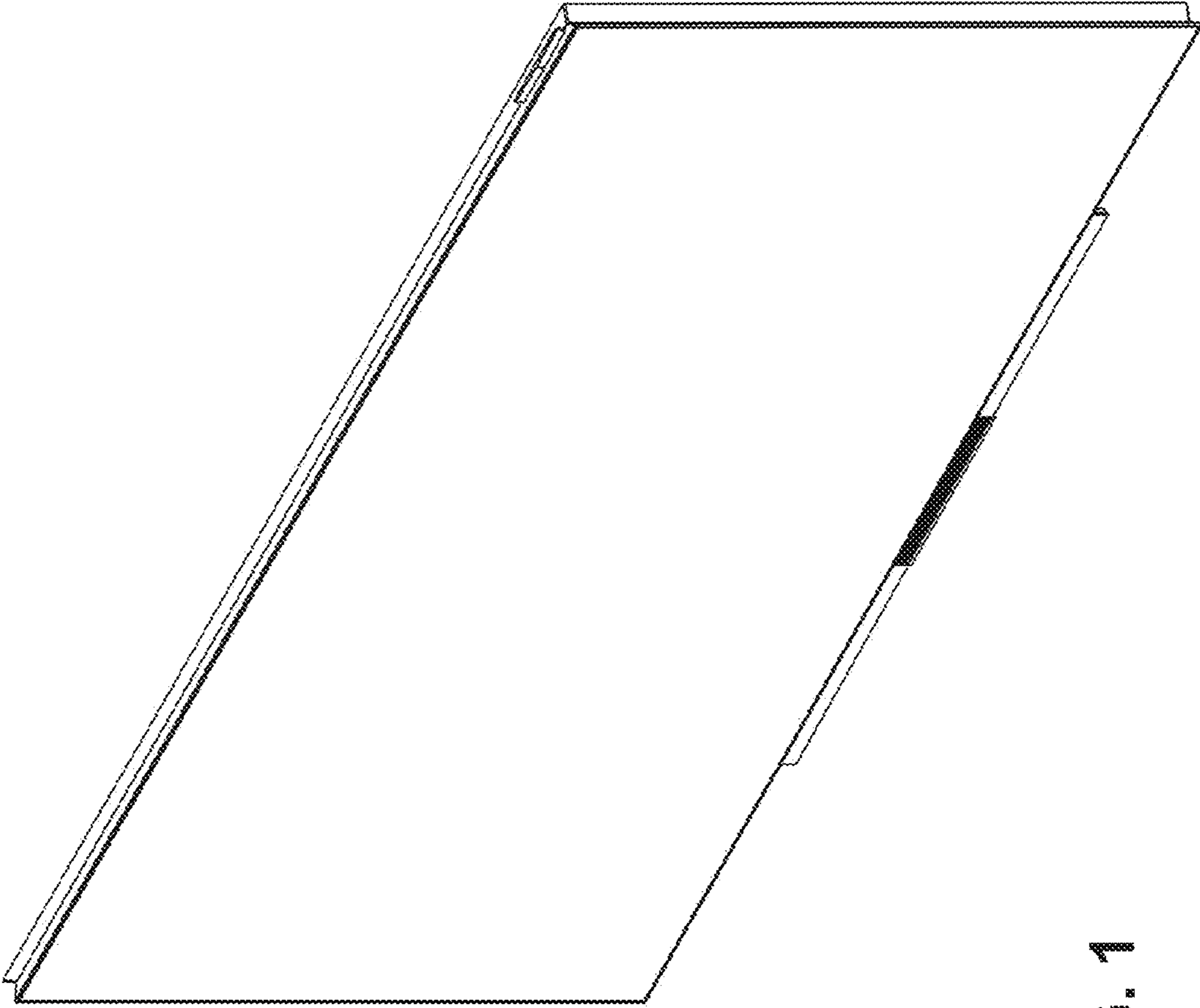

FIG. 1

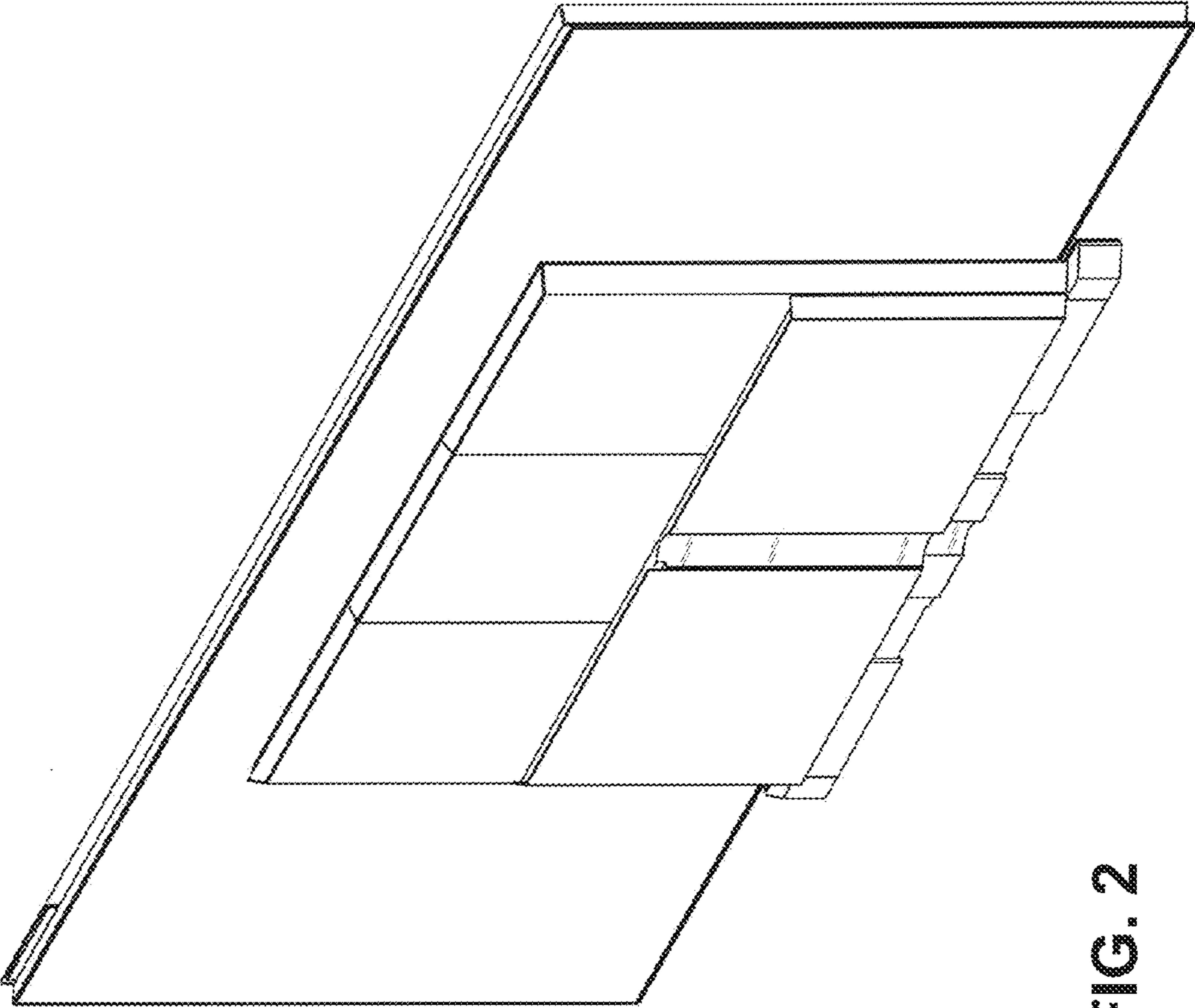

FIG. 2

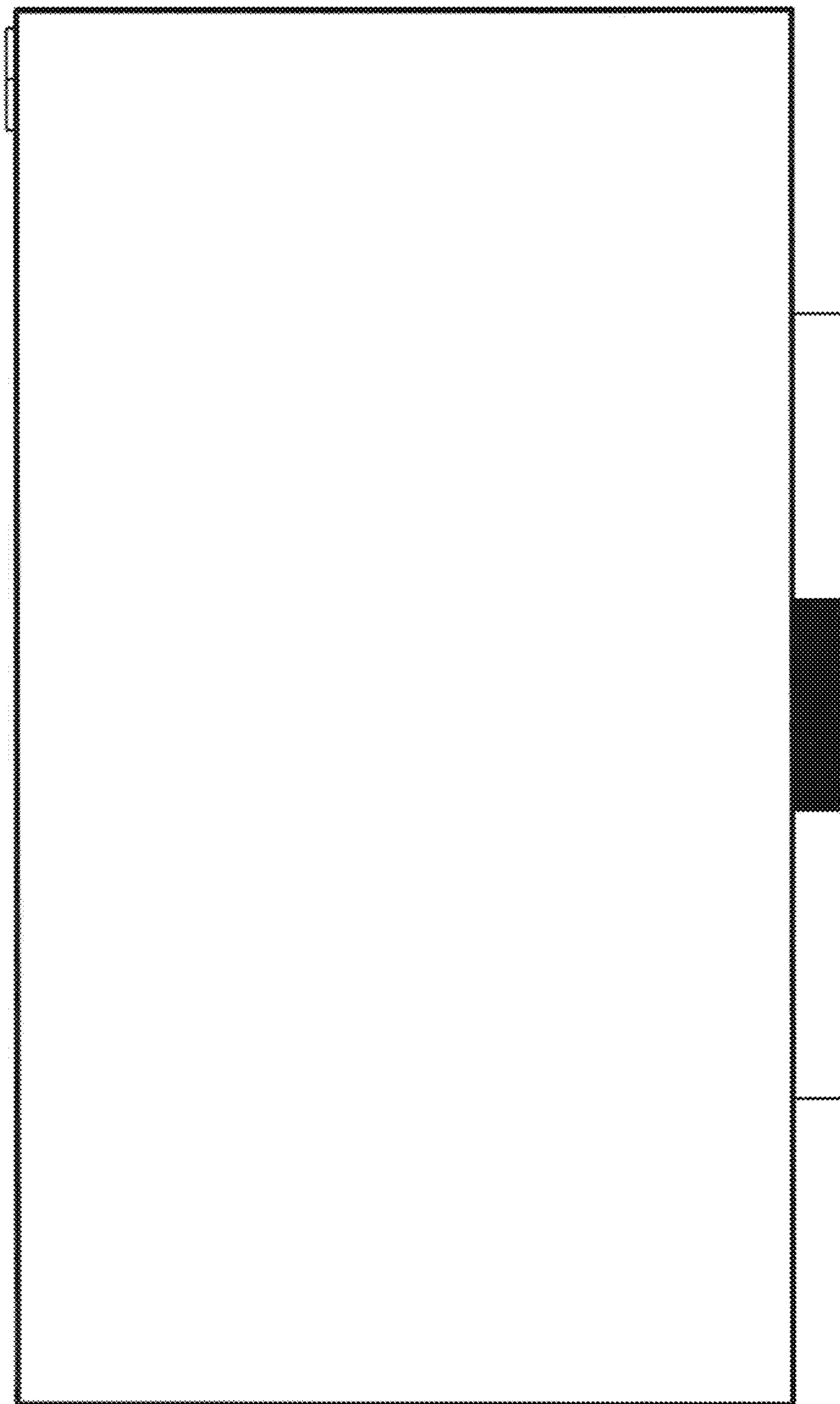

FIG. 3

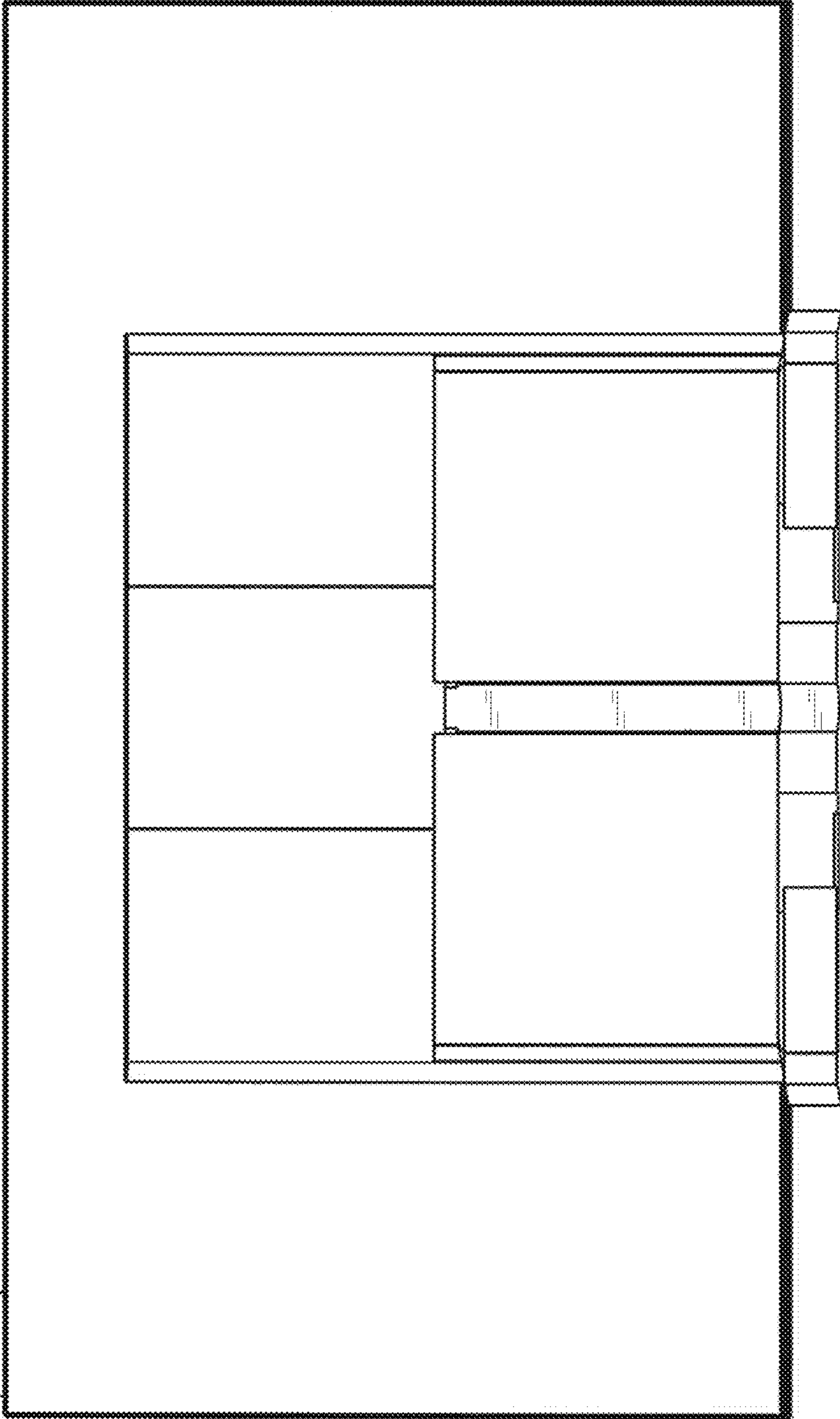

FIG. 4

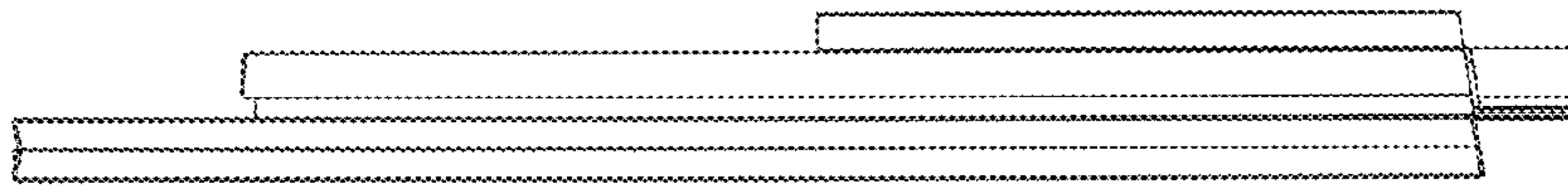

FIG. 5

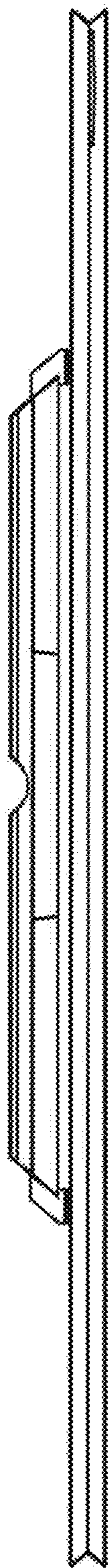

FIG. 6

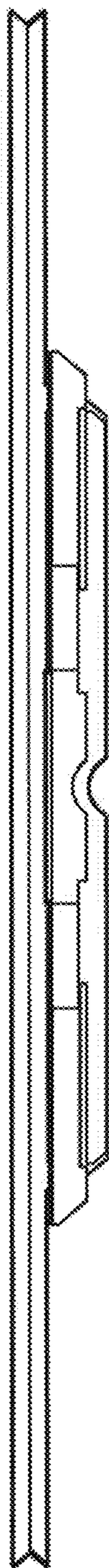

FIG. 7

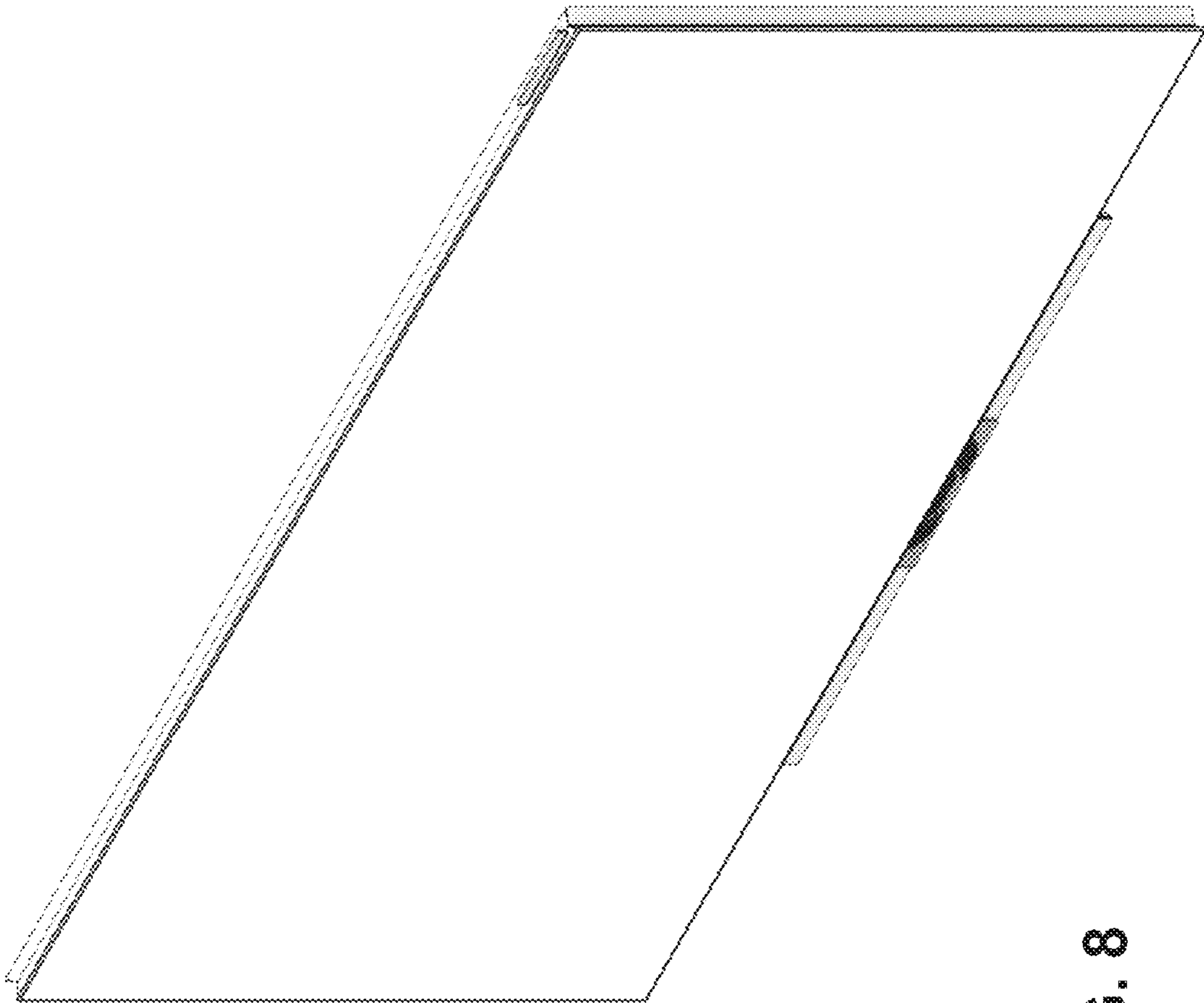

FIG. 8

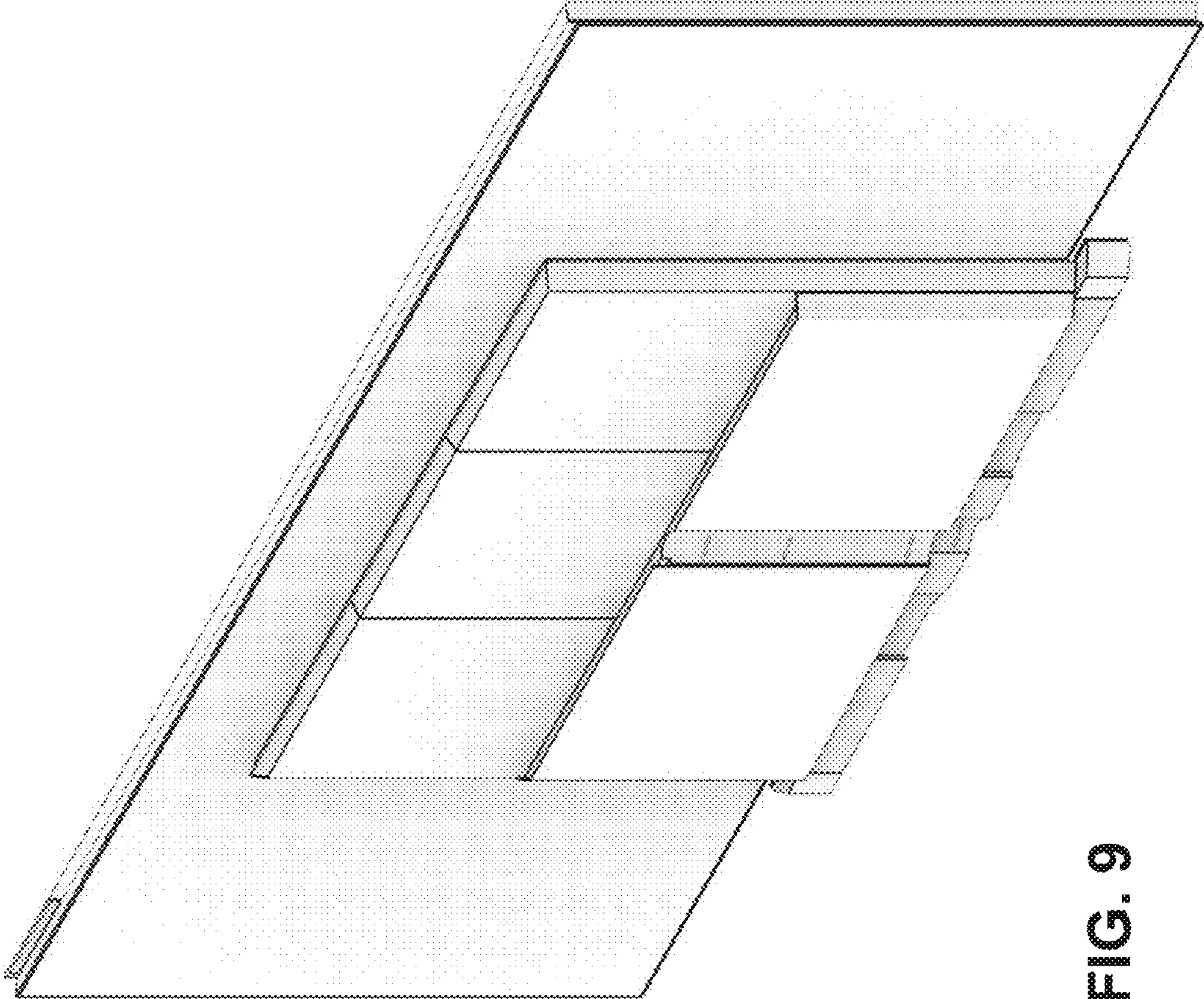

FIG. 9

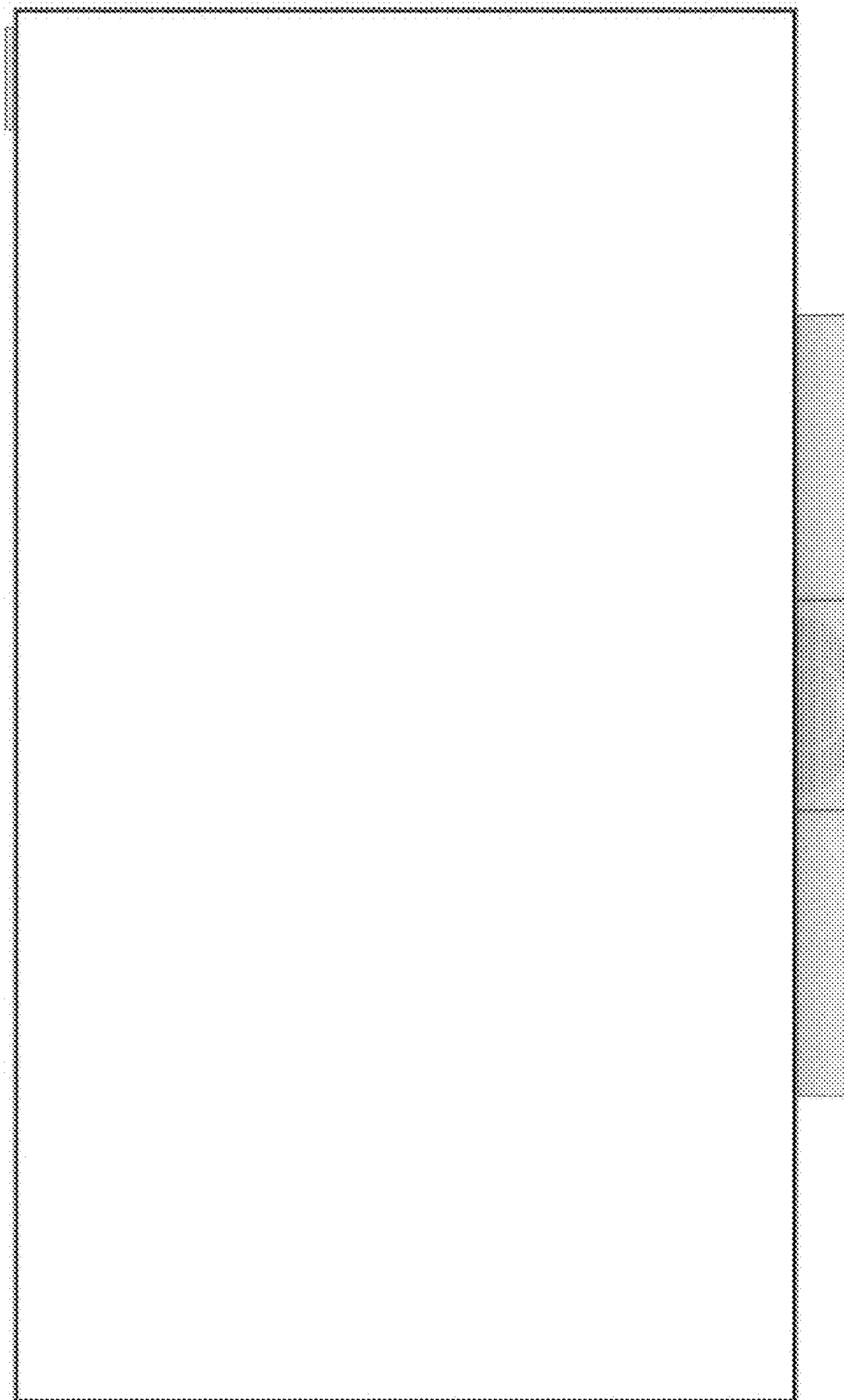

FIG. 10

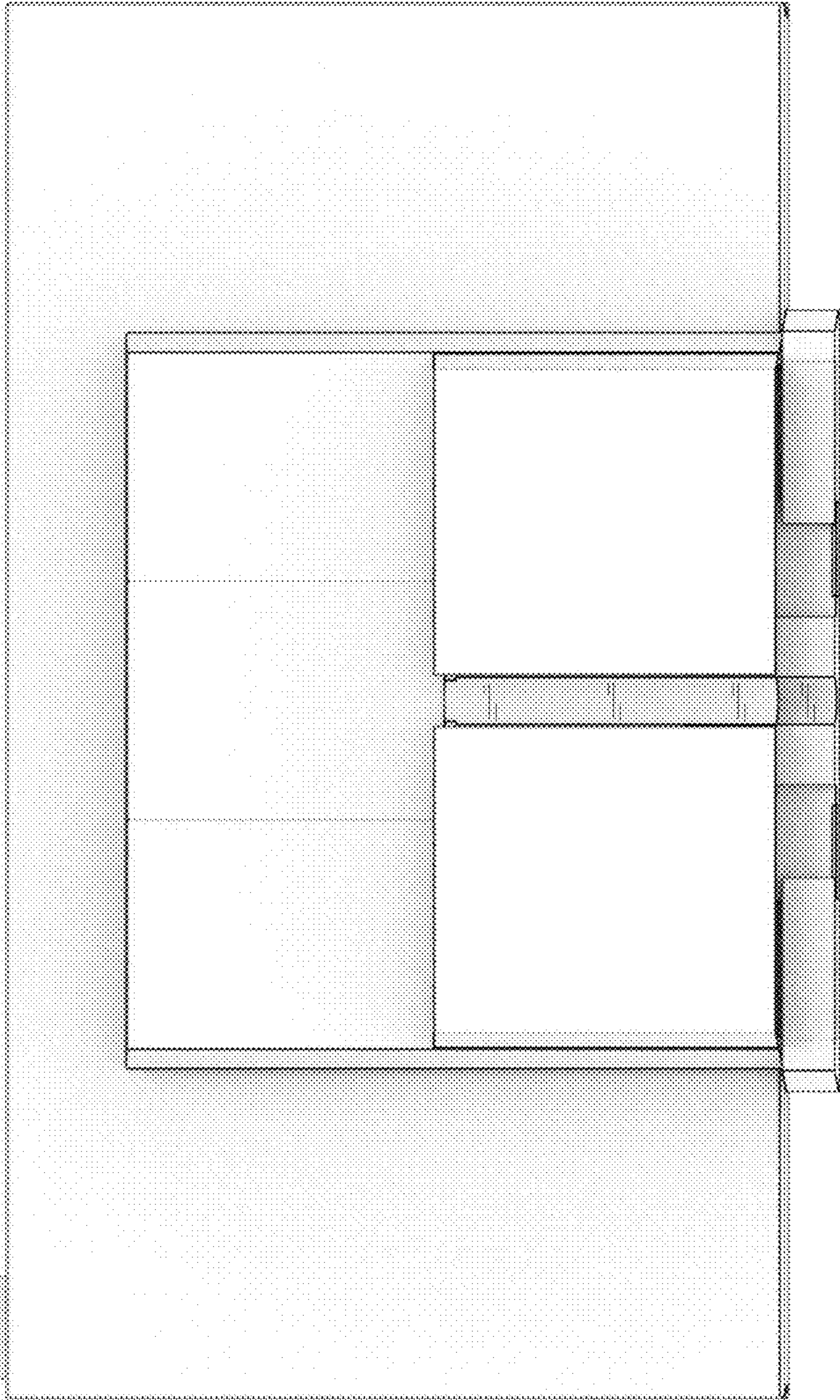

FIG. 11



FIG. 12

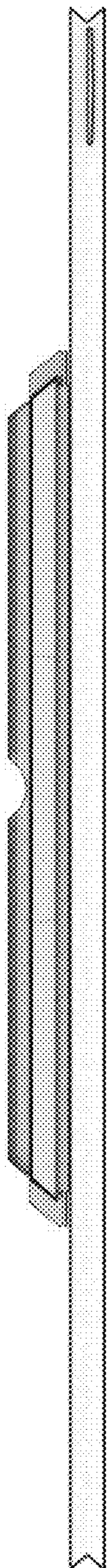

FIG. 13



FIG. 14

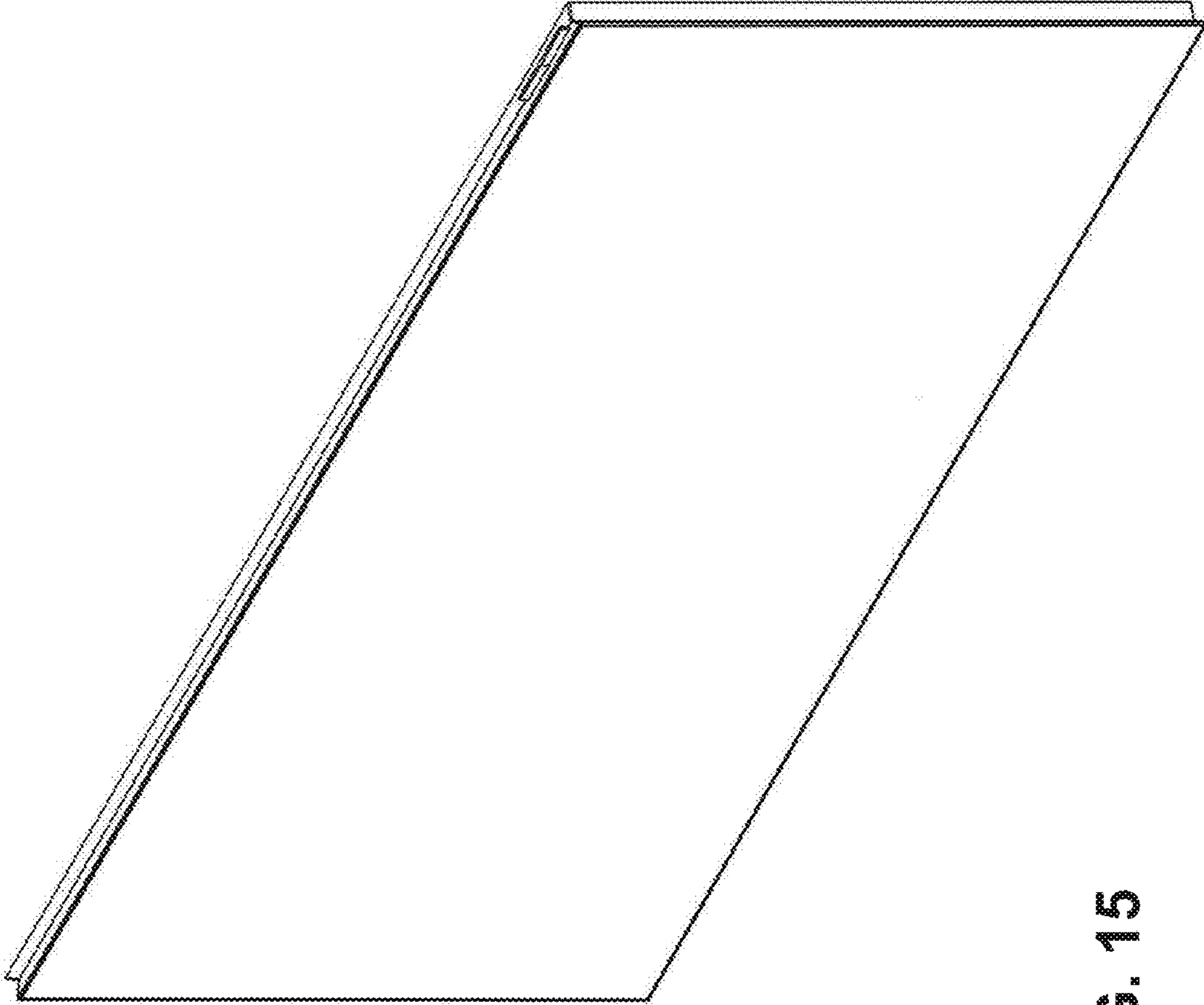

FIG. 15

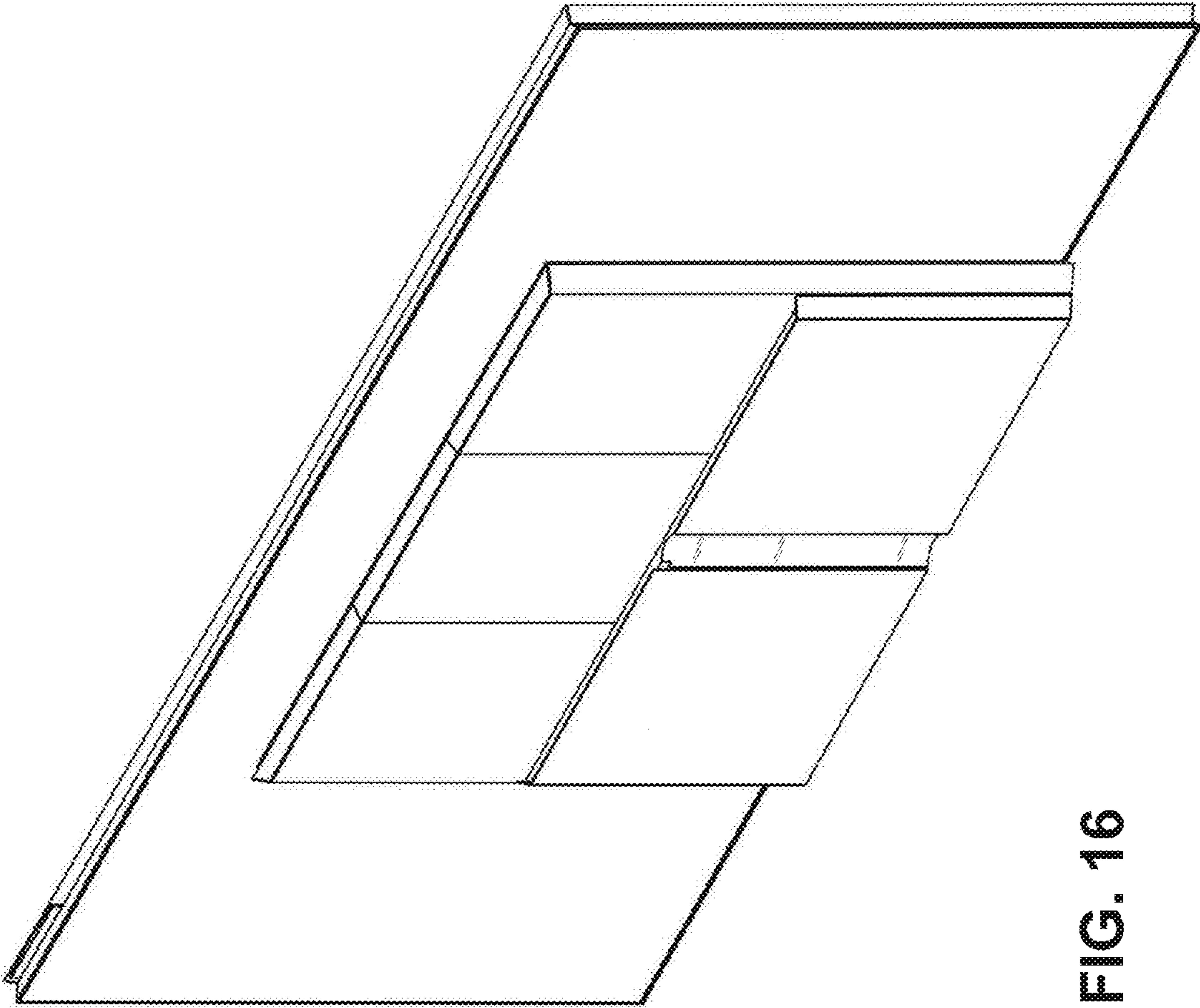

FIG. 16

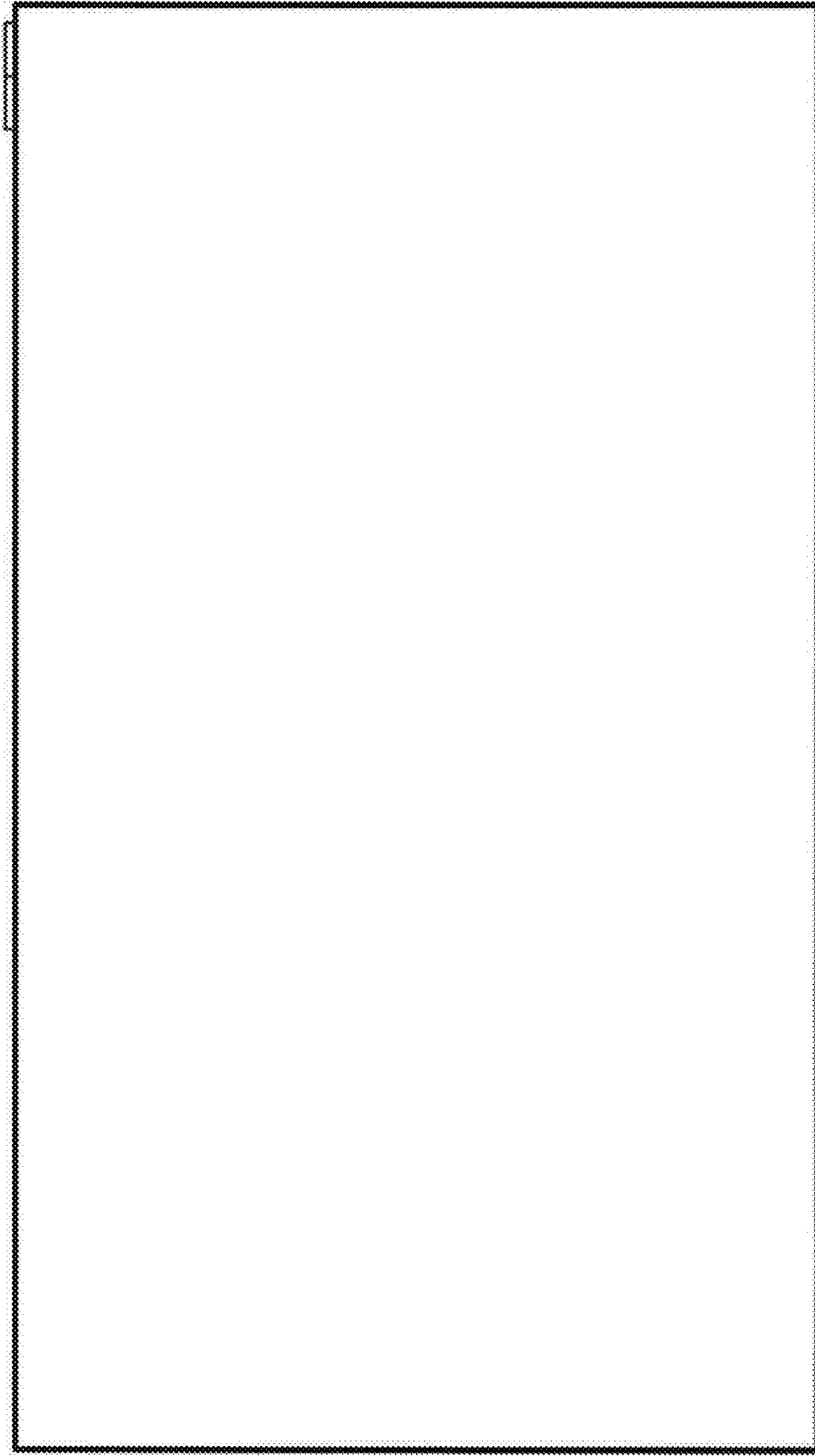

FIG. 17

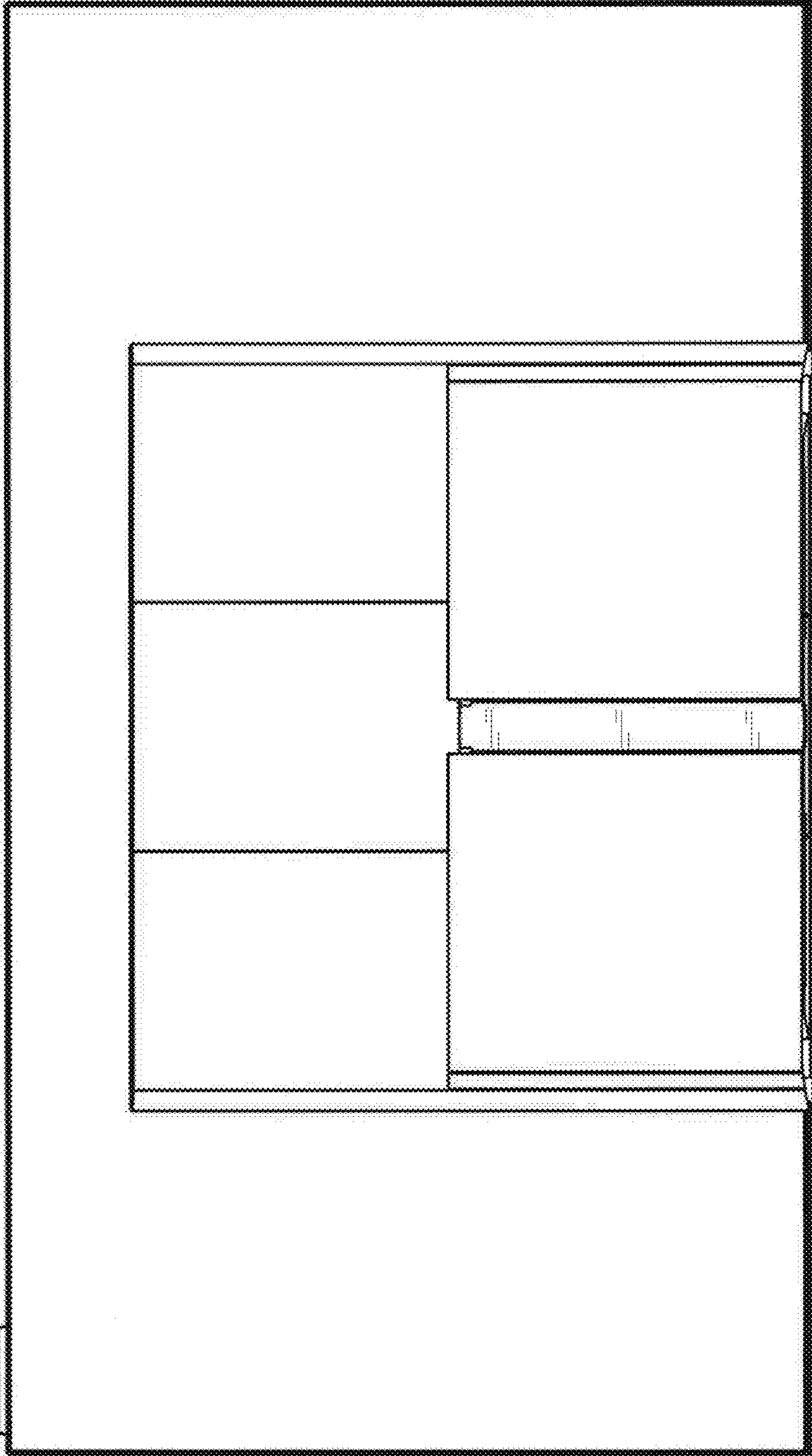

FIG. 18

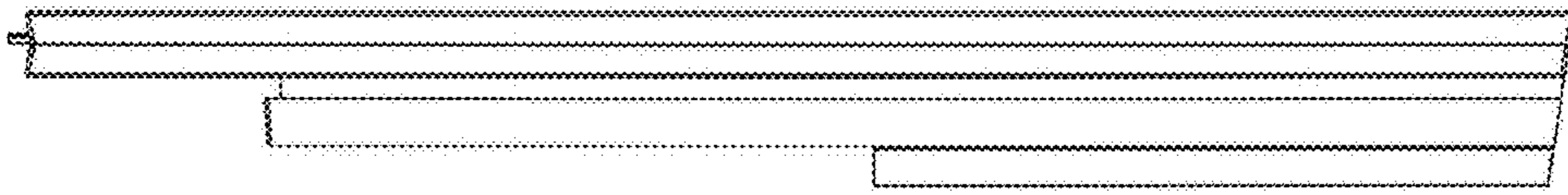

FIG. 19

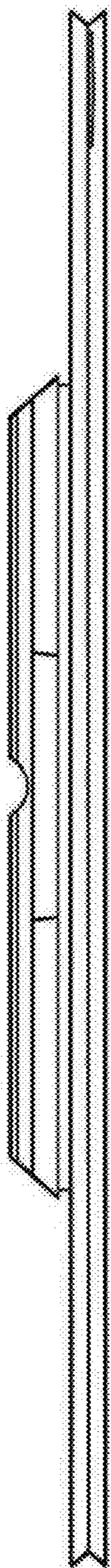

FIG. 20

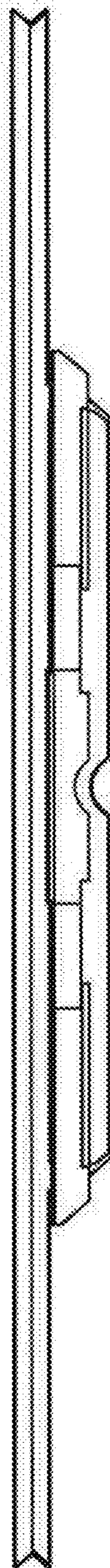

FIG. 21