



US00D754011S

(12) **United States Design Patent**
Bourgeois et al.

(10) **Patent No.:** **US D754,011 S**
(45) **Date of Patent:** **** Apr. 19, 2016**

(54) **WEIGHING SCALE**

(71) Applicant: **PhysioWave, Inc.**, Santa Clara, CA (US)

(72) Inventors: **Solène Bourgeois**, San Francisco, CA (US); **Chris Wilson**, San Francisco, CA (US)

(73) Assignee: **Physiowave, Inc.**, Santa Clara, CA (US)

(**) Term: **14 Years**

(21) Appl. No.: **29/519,627**

(22) Filed: **Mar. 6, 2015**

(51) **LOC (10) Cl.** **10-04**

(52) **U.S. Cl.**
USPC **D10/91**

(58) **Field of Classification Search**
USPC D10/91-92
CPC G01G 3/00-3/18; G01G 7/00-7/06;
G01G 5/00-5/06; G01G 1/00-1/42; G01G
9/00-9/005; G01G 11/00-11/20; G01G
13/00-13/34; G01G 15/00-15/047; G01G
17/00-17/08

See application file for complete search history.

(56) **References Cited**

U.S. PATENT DOCUMENTS

D579,365 S * 10/2008 Kitamura D10/92
D718,162 S 11/2014 Kobayakawa
D740,147 S * 10/2015 Pestl D10/92

* cited by examiner

Primary Examiner — Antoine D Davis

(74) *Attorney, Agent, or Firm* — Crawford Maunu PLLC

(57) **CLAIM**

The ornamental design for weighing scale, as shown and described.

DESCRIPTION

FIG. 1 is a perspective view of a weighing scale, with the top and two sides shown, according to an embodiment of the present design;

FIG. 2 is a perspective view of the above embodiment of the scale, with the bottom and two sides shown;

FIG. 3 is a top view of the scale;

FIG. 4 is a bottom view of the scale;

FIG. 5 is a side view of one side of the scale, which is identical to the other side which is parallel thereto; and,

FIG. 6 is a side view of another (adjacent) side of the scale, which is identical to the other side which is parallel thereto.

Aspects that do not form part of the claimed design include the center (circular) portion of the scale feet as shown FIGS. 2, 4, 5 and 6, and the rectangular panel (e.g., compartment for battery or other powering devices), as shown in FIGS. 2 and 4.

1 Claim, 5 Drawing Sheets

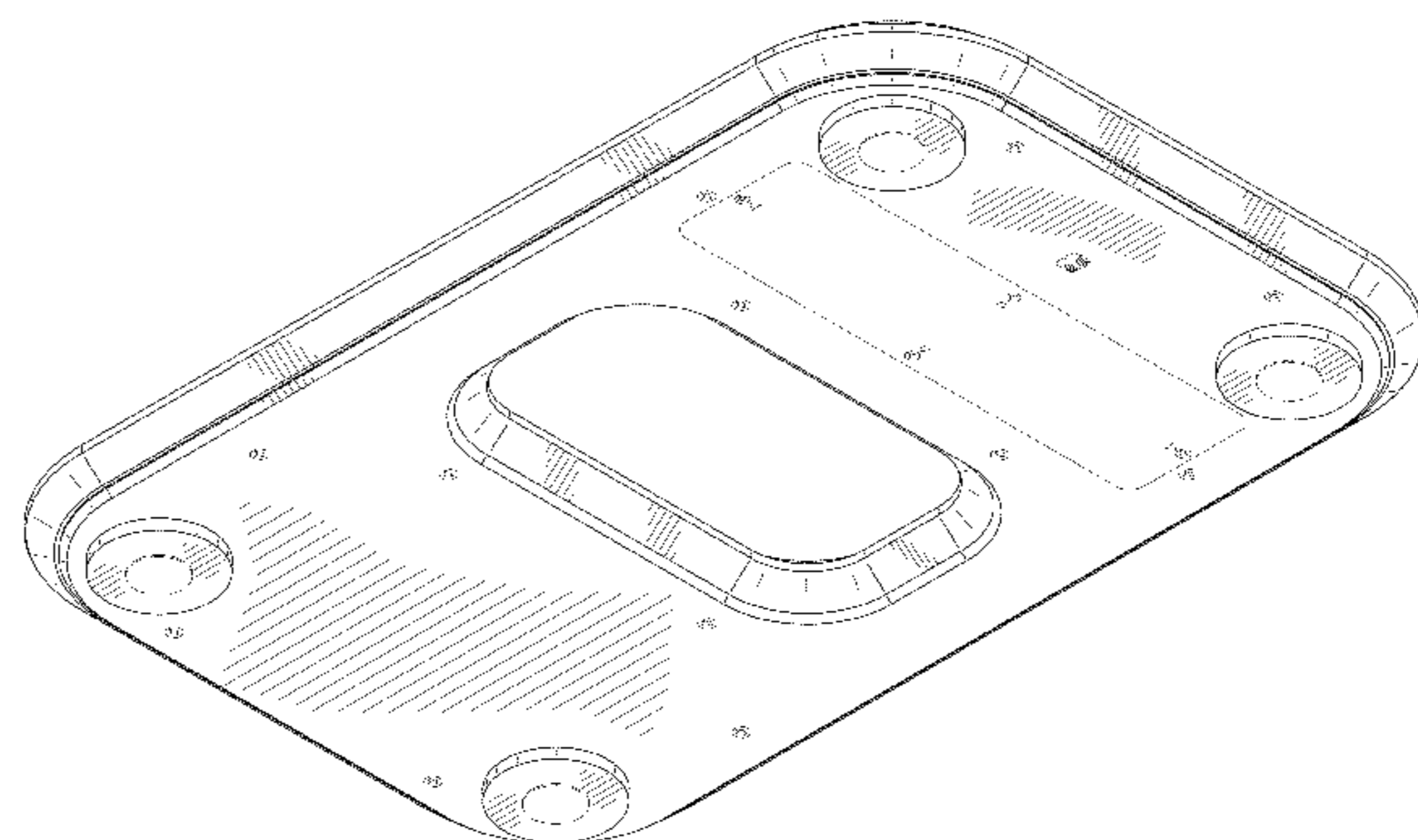
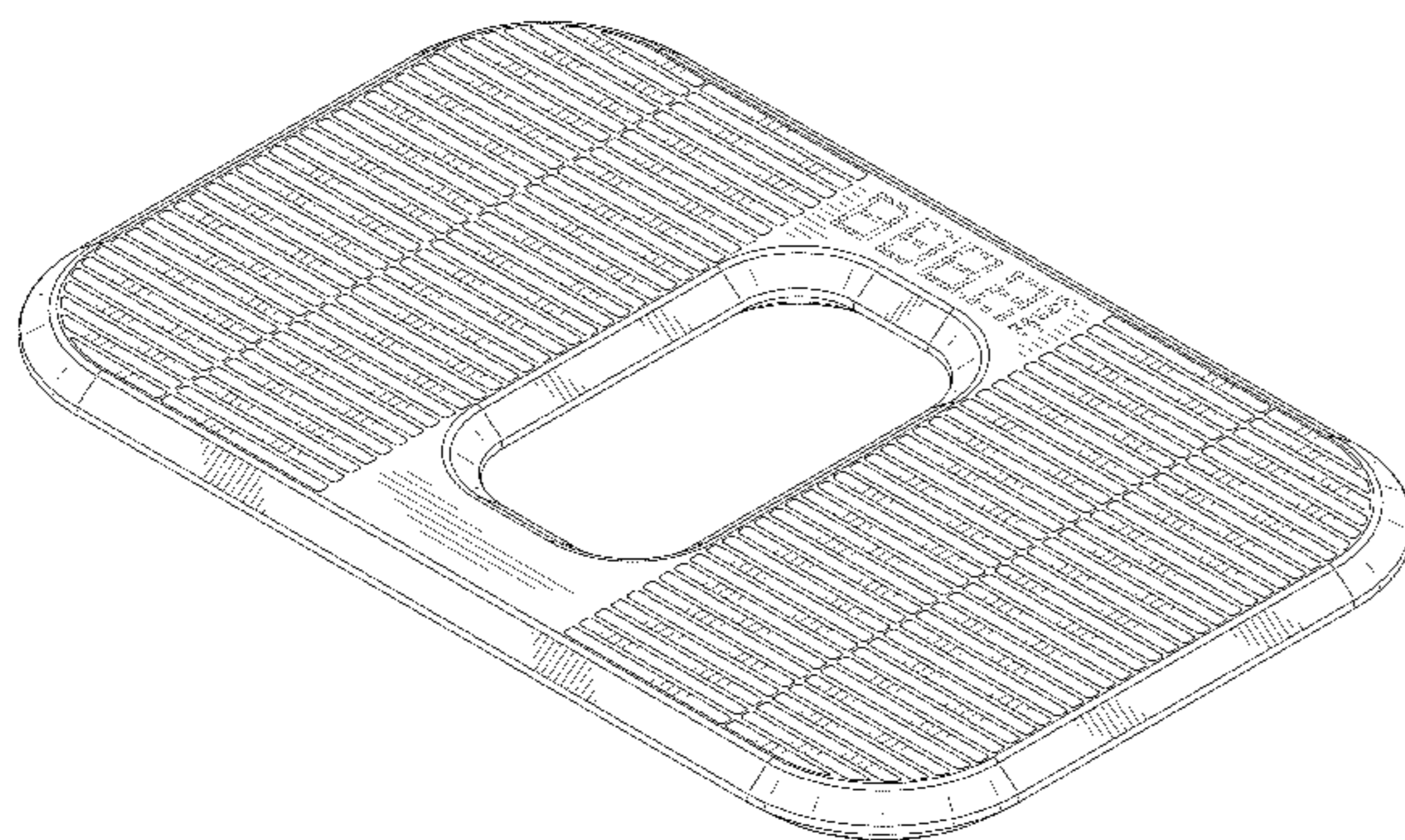

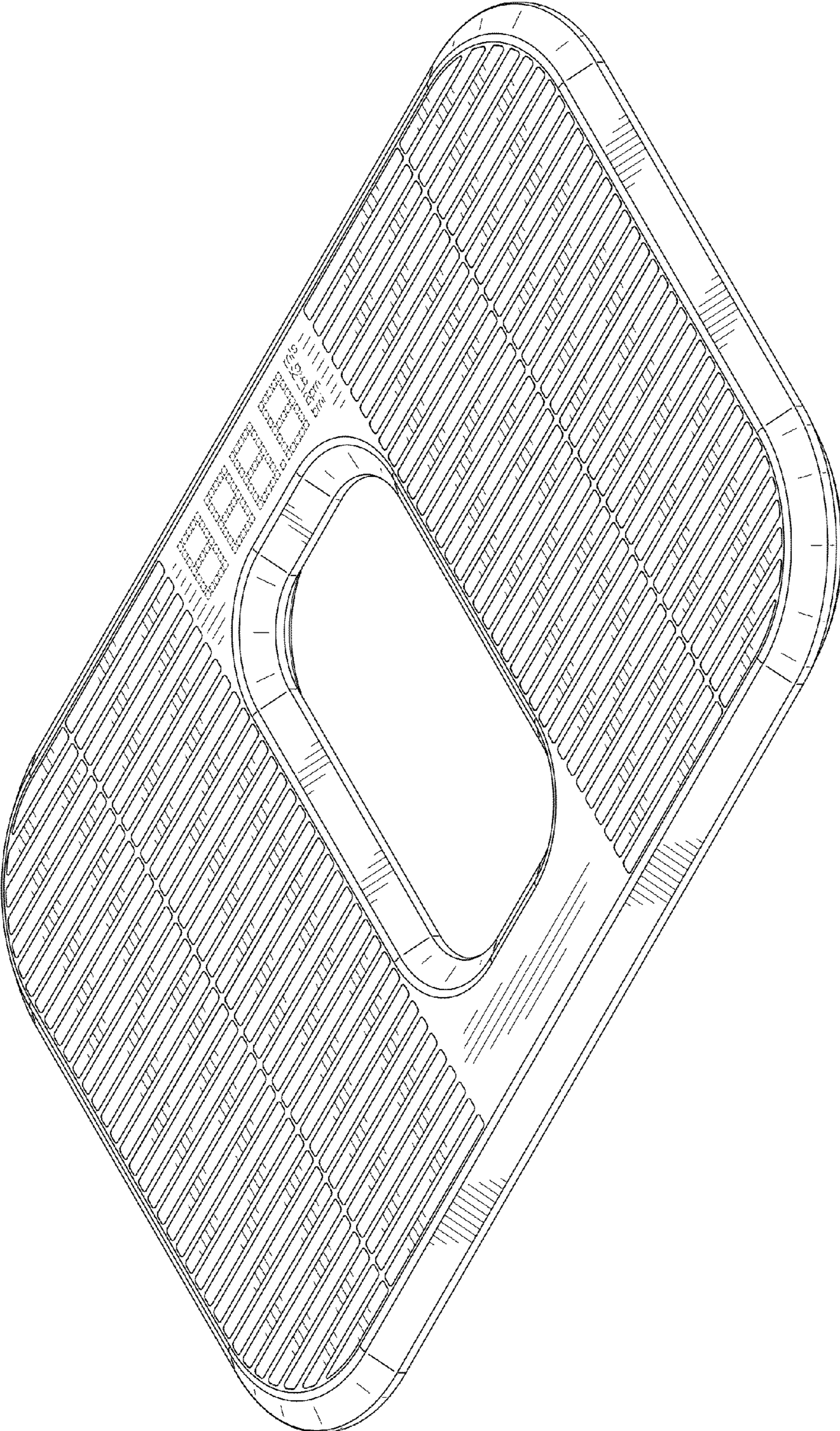

FIG. 1

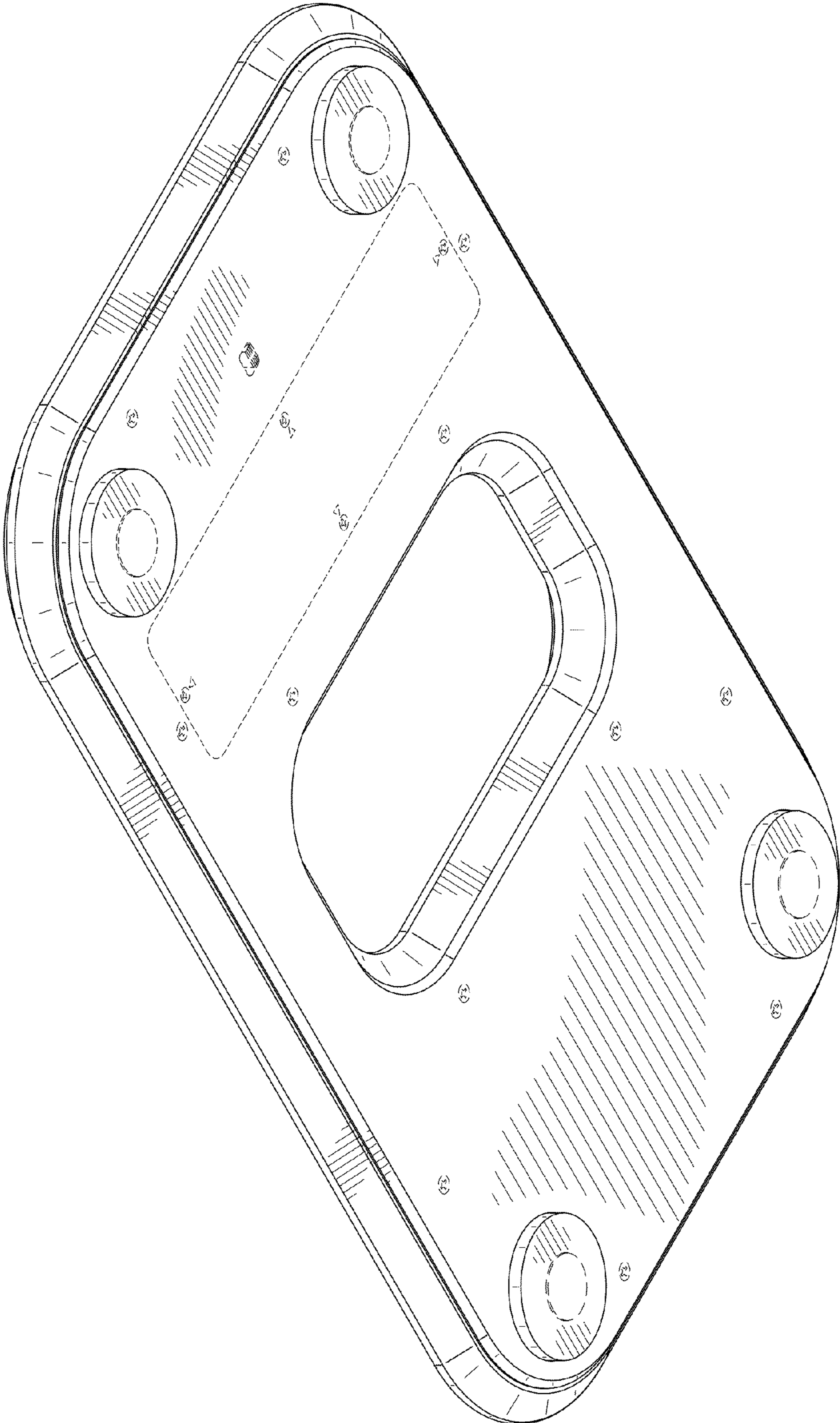

FIG. 2

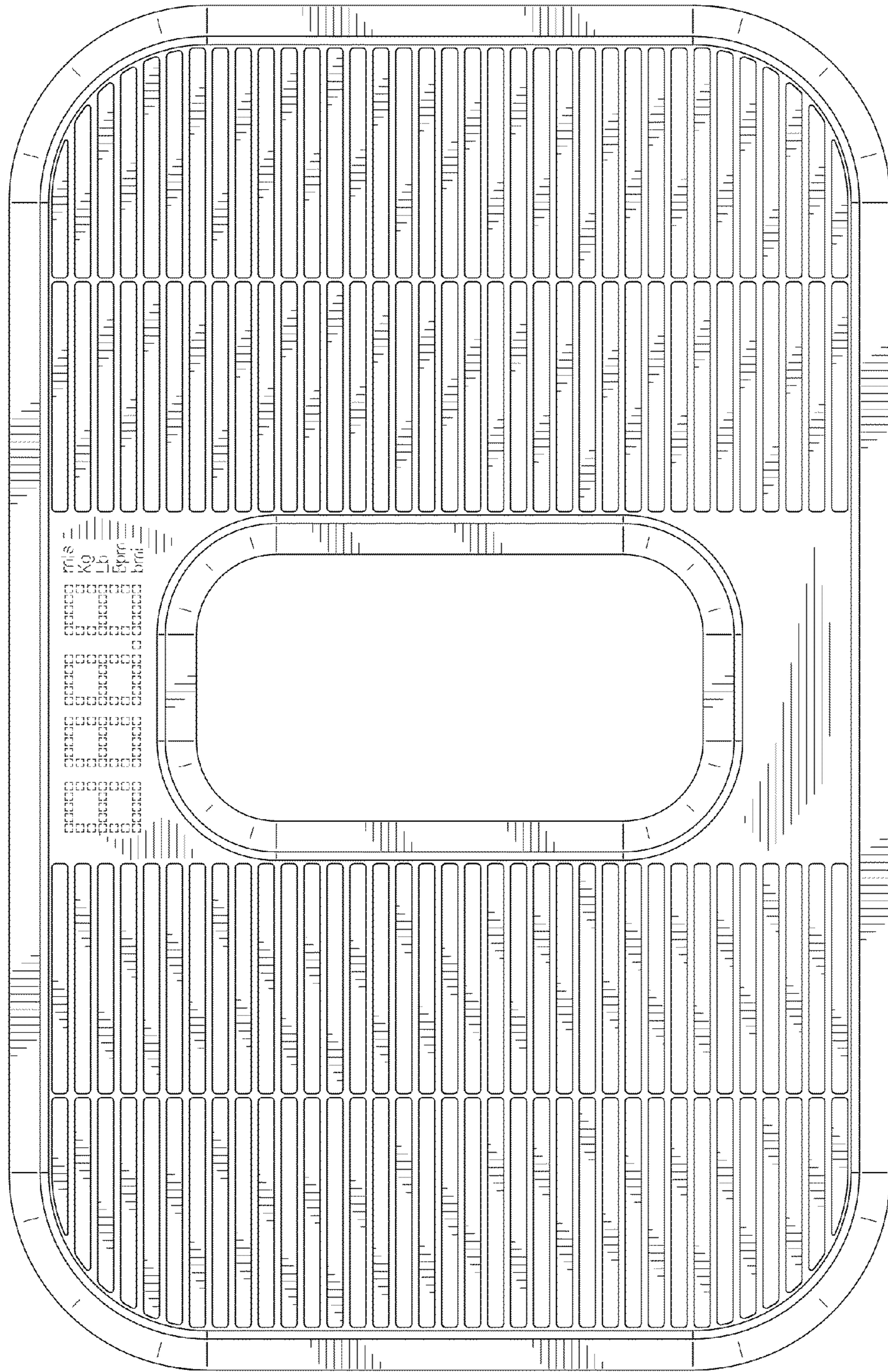

FIG. 3

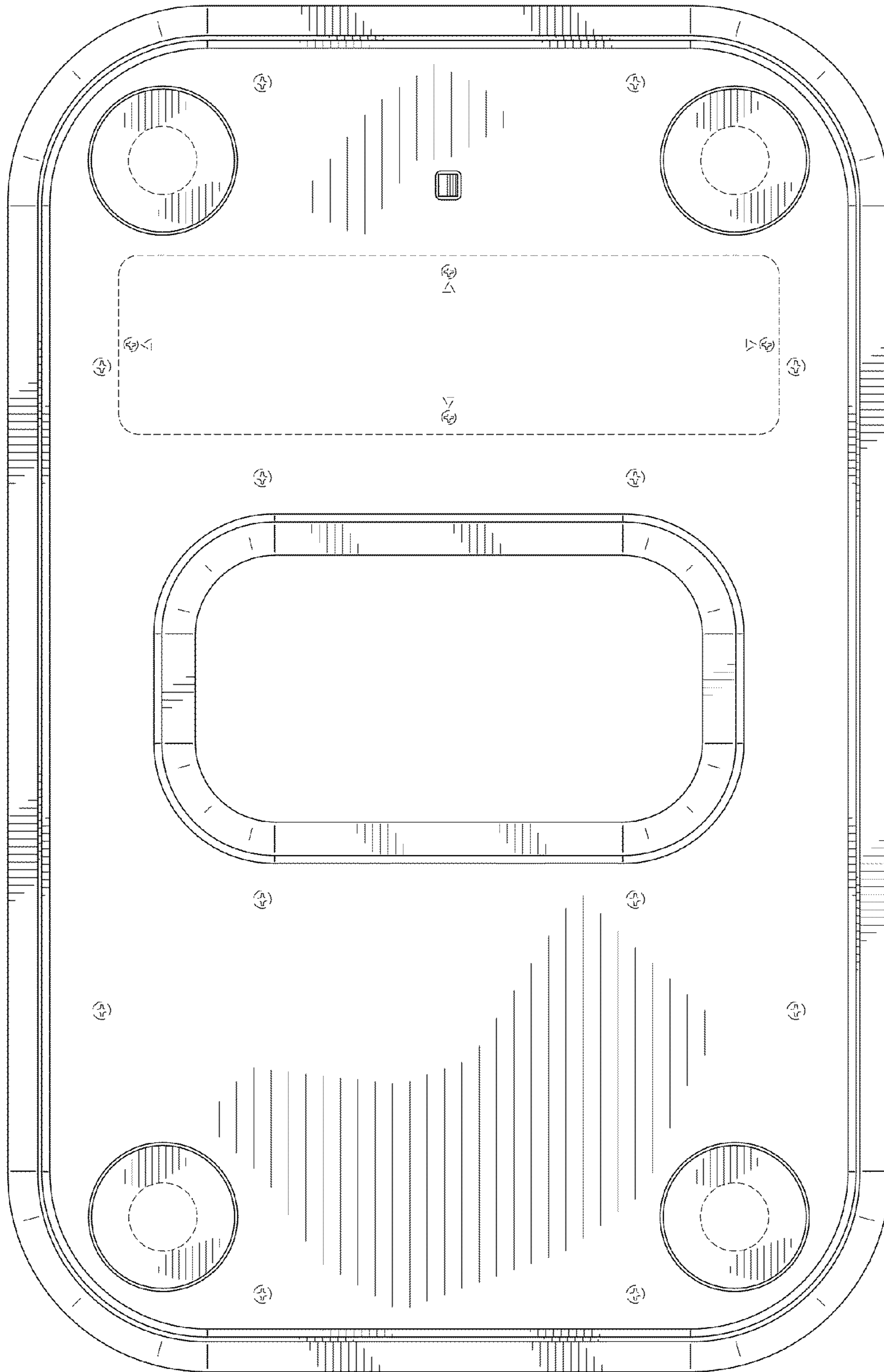

FIG. 4

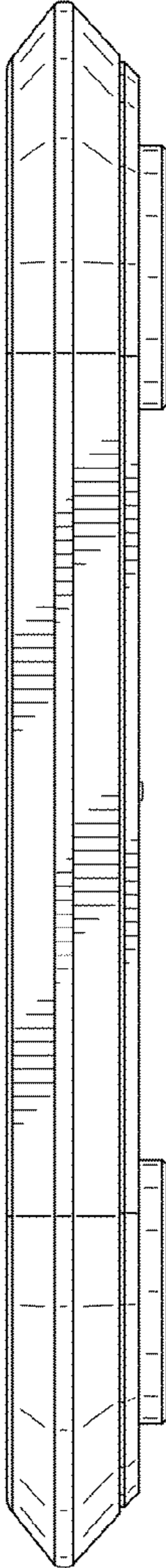

FIG. 5

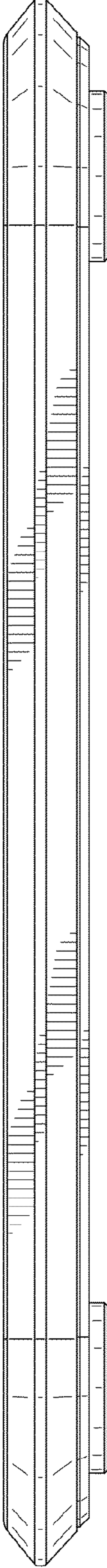

FIG. 6