



US00D753935S

(12) **United States Design Patent**
Driffield

(10) **Patent No.:** **US D753,935 S**
(45) **Date of Patent:** **** Apr. 19, 2016**

- (54) **BED FOUNDATION**
- (71) Applicant: **MARSHALL VENTILATED MATTRESS COMPANY LIMITED**, North York (CA)
- (72) Inventor: **Richard Driffield**, Pickering (CA)
- (73) Assignee: **Marshall Ventilated Mattress Company Limited**, North York, ON (CA)
- (**) Term: **14 Years**
- (21) Appl. No.: **29/458,278**
- (22) Filed: **Jun. 18, 2013**
- (51) **LOC (10) Cl.** **06-02**
- (52) **U.S. Cl.**
USPC **D6/606**
- (58) **Field of Classification Search**
USPC D6/382, 388, 393, 406.1, 406.3, 599, D6/602, 604-607, 642, 646, 647, 650, 653, D6/653.11, 653.16, 653.18, 653.19, 655, D6/655.17, 655.18, 655.2, 655.23, 655.22, D6/656.1, 656.11-656.13, 656.19, 665, D6/665.23, 708; D8/403; D25/113, D25/115-117, 133, 136; 5/400, 504.1, 5/505.1, 506.1, 507.1, 706-708, 710-711
CPC A47C 23/00; A47C 23/02; A47C 23/06; A47C 27/06; A47C 27/08; A47C 27/081; A47C 27/128; A47C 31/12
See application file for complete search history.

- (56) **References Cited**
U.S. PATENT DOCUMENTS
897,541 A * 9/1908 Kilburn et al. 5/409
1,287,590 A * 12/1918 Meusch 5/720
2,360,966 A * 10/1944 Mouw 5/246
3,626,523 A * 12/1971 Robins 5/716
D245,747 S * 9/1977 Ikeda D6/606

4,086,675	A *	5/1978	Talbert et al.	5/655.9
5,231,714	A *	8/1993	Mossbeck	5/400
5,289,600	A *	3/1994	Schermel	5/400
5,561,876	A *	10/1996	Petruzella	5/724
D490,635	S *	6/2004	Boso et al.	D6/604
6,782,575	B1 *	8/2004	Robinson	5/740
6,983,500	B2 *	1/2006	Wootten	5/497
7,941,882	B1 *	5/2011	Strozer	5/693
D665,615	S *	8/2012	Frame et al.	D6/606
8,312,576	B1 *	11/2012	Oh	5/250
8,407,834	B1 *	4/2013	Oh	5/250
8,522,376	B2 *	9/2013	Rohr et al.	5/411
8,555,435	B1 *	10/2013	Schiller et al.	5/263
8,769,740	B2 *	7/2014	Oh	5/250
8,782,830	B2 *	7/2014	Brykalski et al.	5/423
2003/0093864	A1 *	5/2003	Visser et al.	5/720
2004/0040090	A1 *	3/2004	Wootten	5/497
2004/0128761	A1 *	7/2004	Gaboury et al.	5/400

(Continued)

Primary Examiner — Karen S Acker
Assistant Examiner — Clare Ann Gannon

(57) **CLAIM**
I claim the ornamental design for a bed foundation, as shown and described.

DESCRIPTION

FIG. 1 is a perspective view of a bed foundation showing the present design in a position of use;
FIG. 2 is an enlarged detail view of the bed foundation of FIG. 1;
FIG. 3 is a top view thereof;
FIG. 4 is a front elevational view thereof;
FIG. 5 is a left side elevational view thereof;
FIG. 6 is a perspective view of a second embodiment of the bed foundation of the present design; and,
FIG. 7 is a top view thereof.
The broken lines in FIG. 1 depict portions of the bed foundation that are not included in the claim and indicate the outer limits to the claim. The broken lines in FIGS. 2-7 represent the boundaries of the claim and form no part thereof.

1 Claim, 7 Drawing Sheets

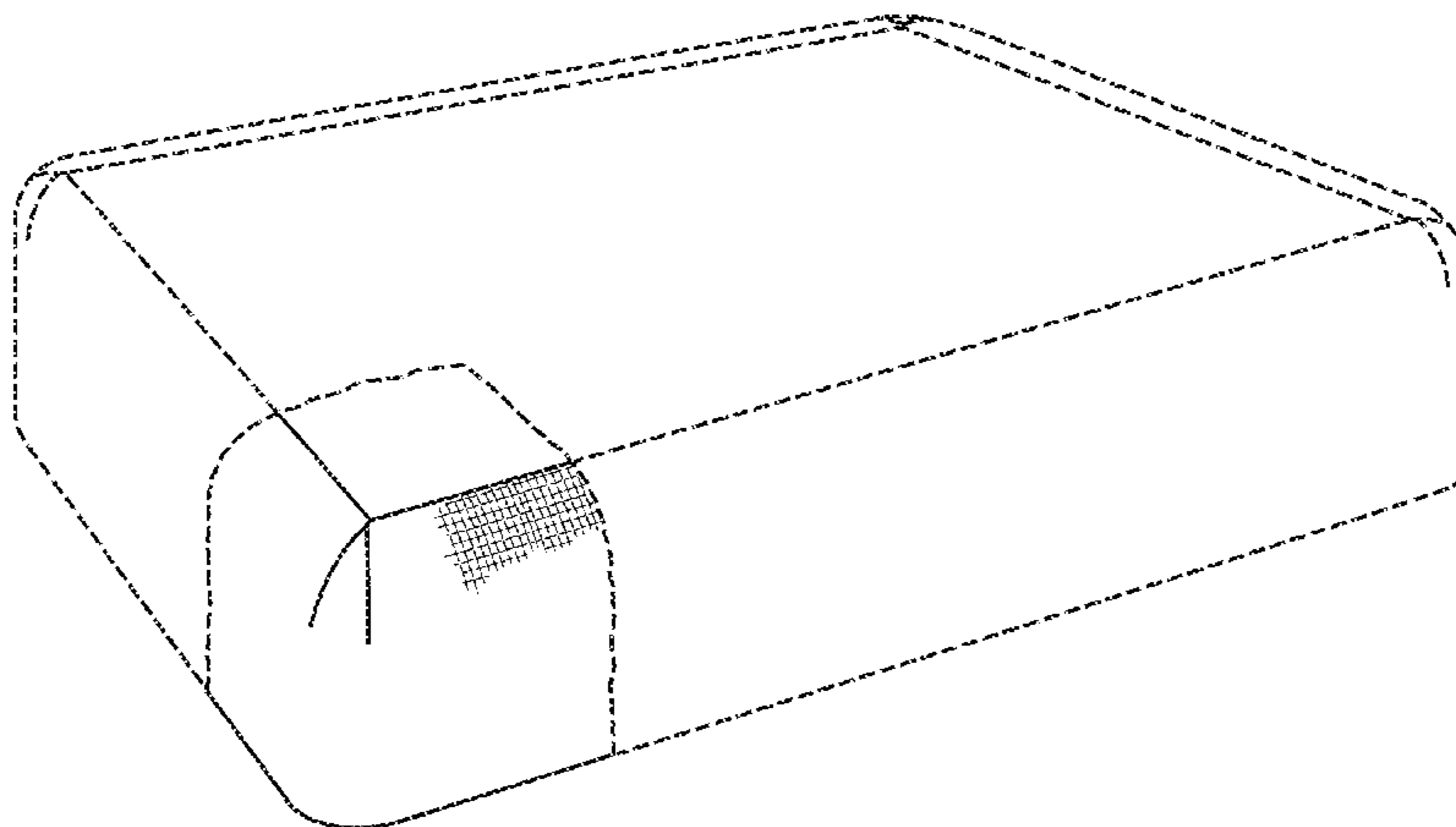

US D753,935 S

Page 2

(56)

References Cited

U.S. PATENT DOCUMENTS

2004/0148706	A1 *	8/2004	Visser et al.	5/720	
2008/0052825	A1 *	3/2008	Wolff	5/201	* cited by examiner
2009/0070941	A1 *	3/2009	Lau	5/706	
2009/0222985	A1 *	9/2009	Richmond et al.	5/247	
2013/0086743	A1 *	4/2013	Saunders et al.	5/400	

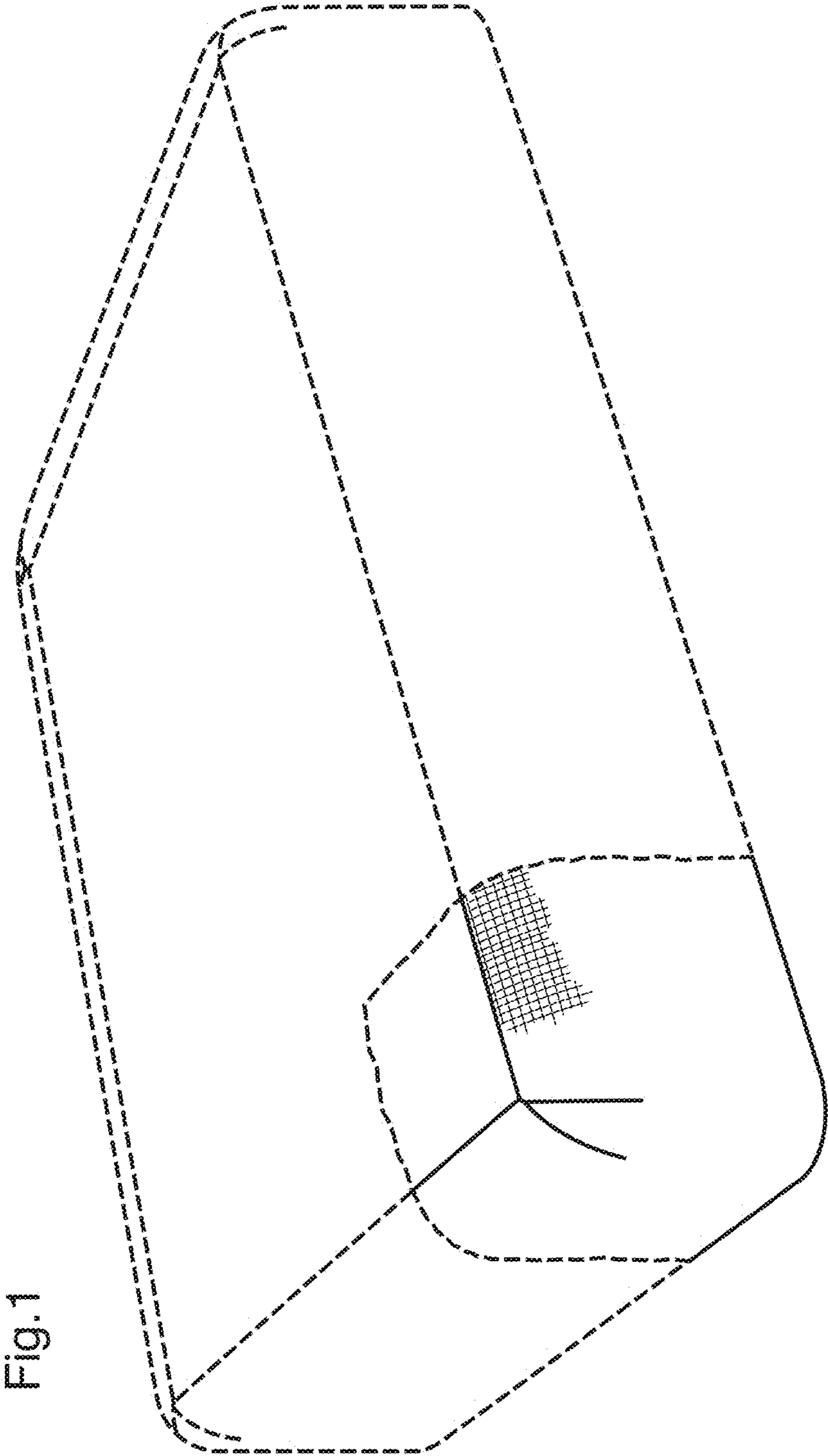

Fig. 1

Fig.2

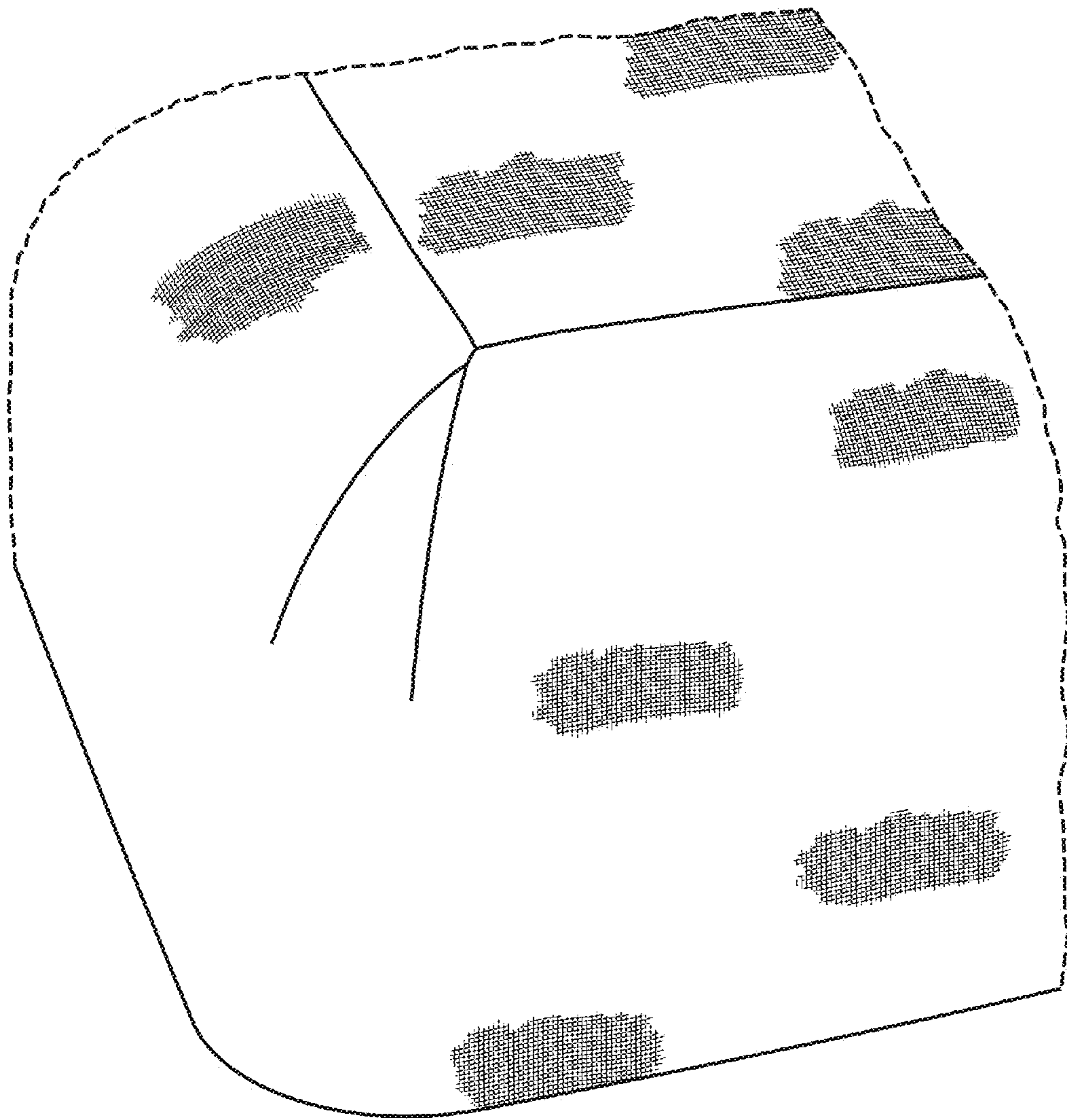

Fig.3

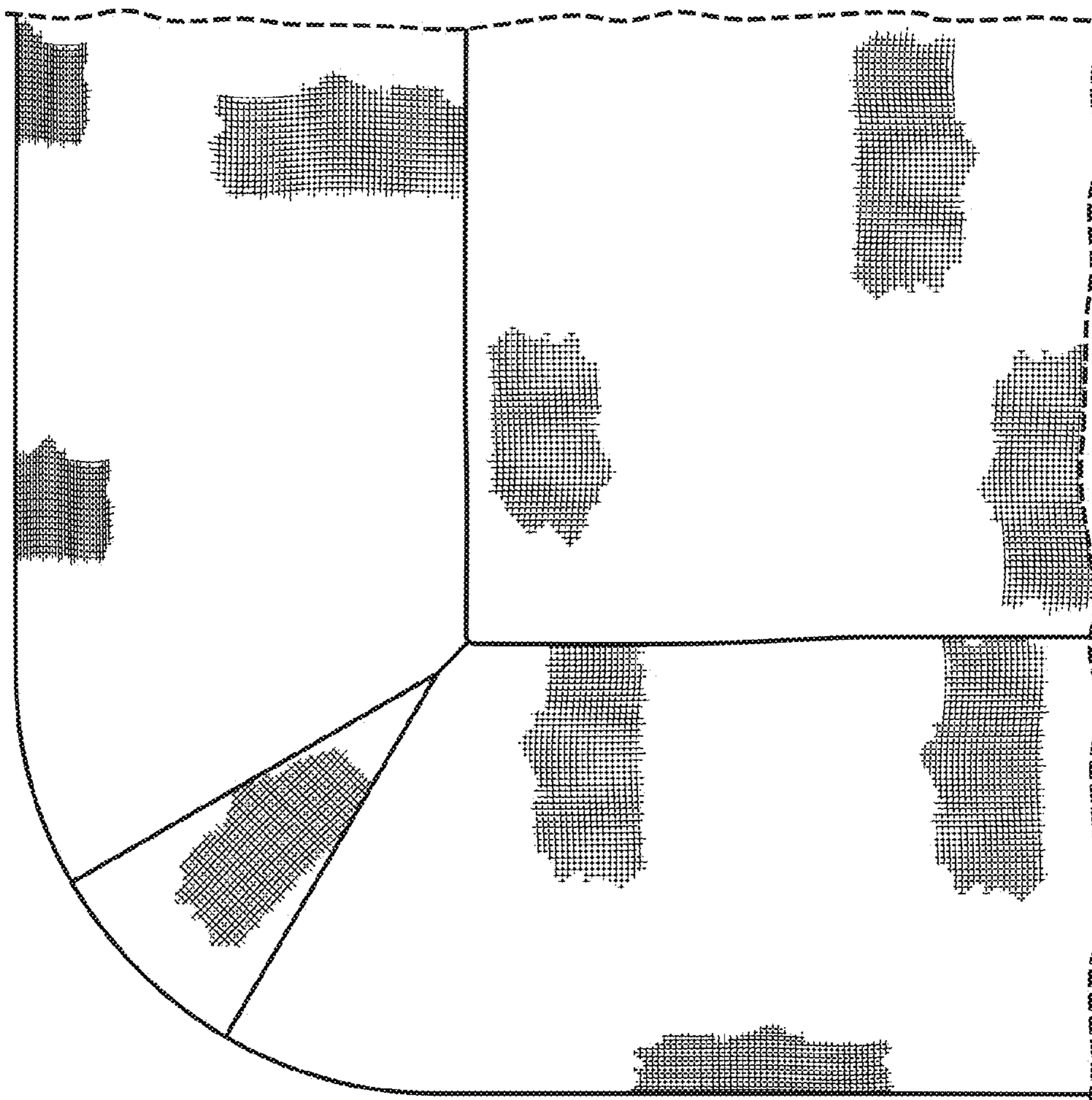

Fig.4

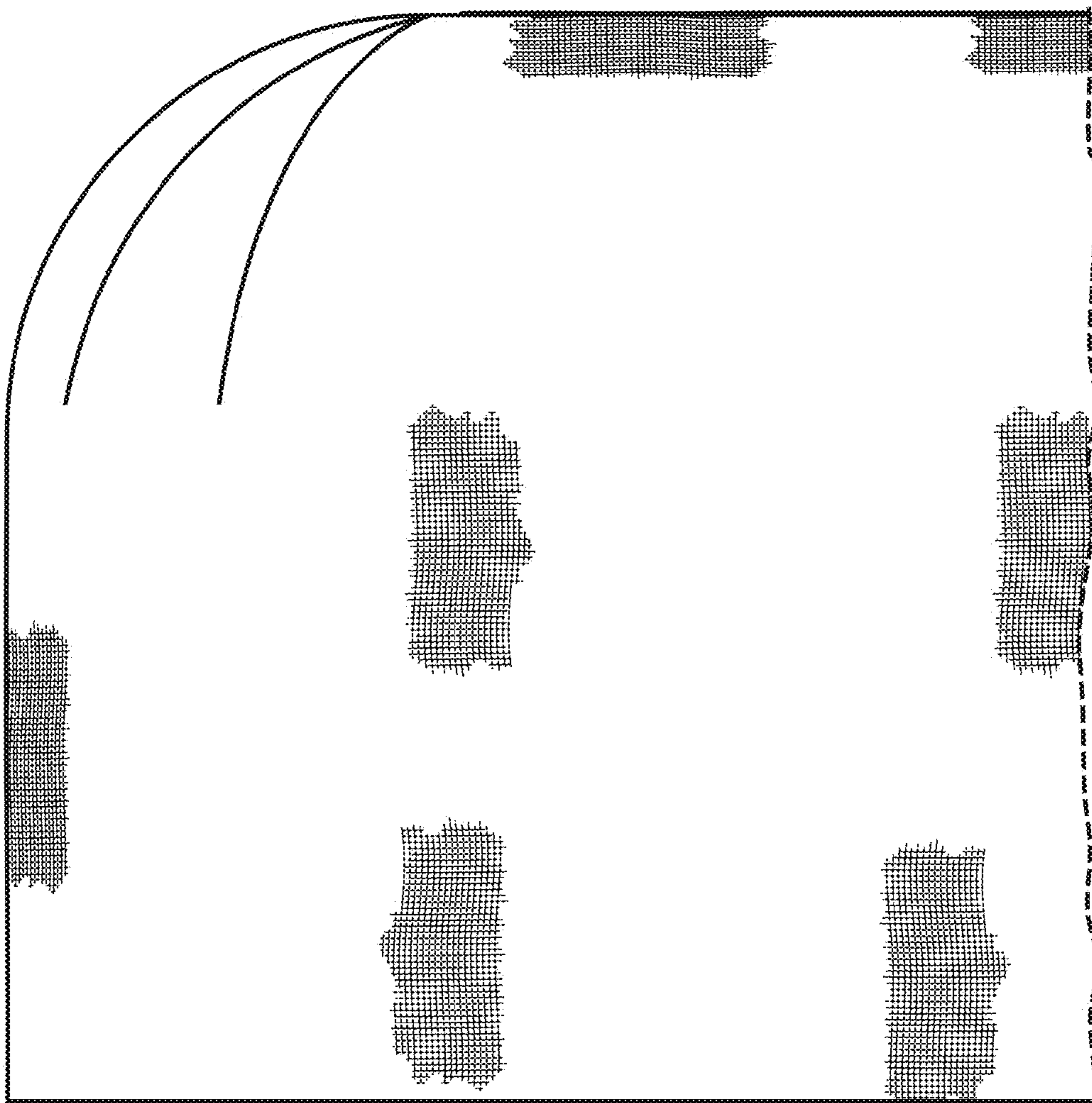

Fig.5

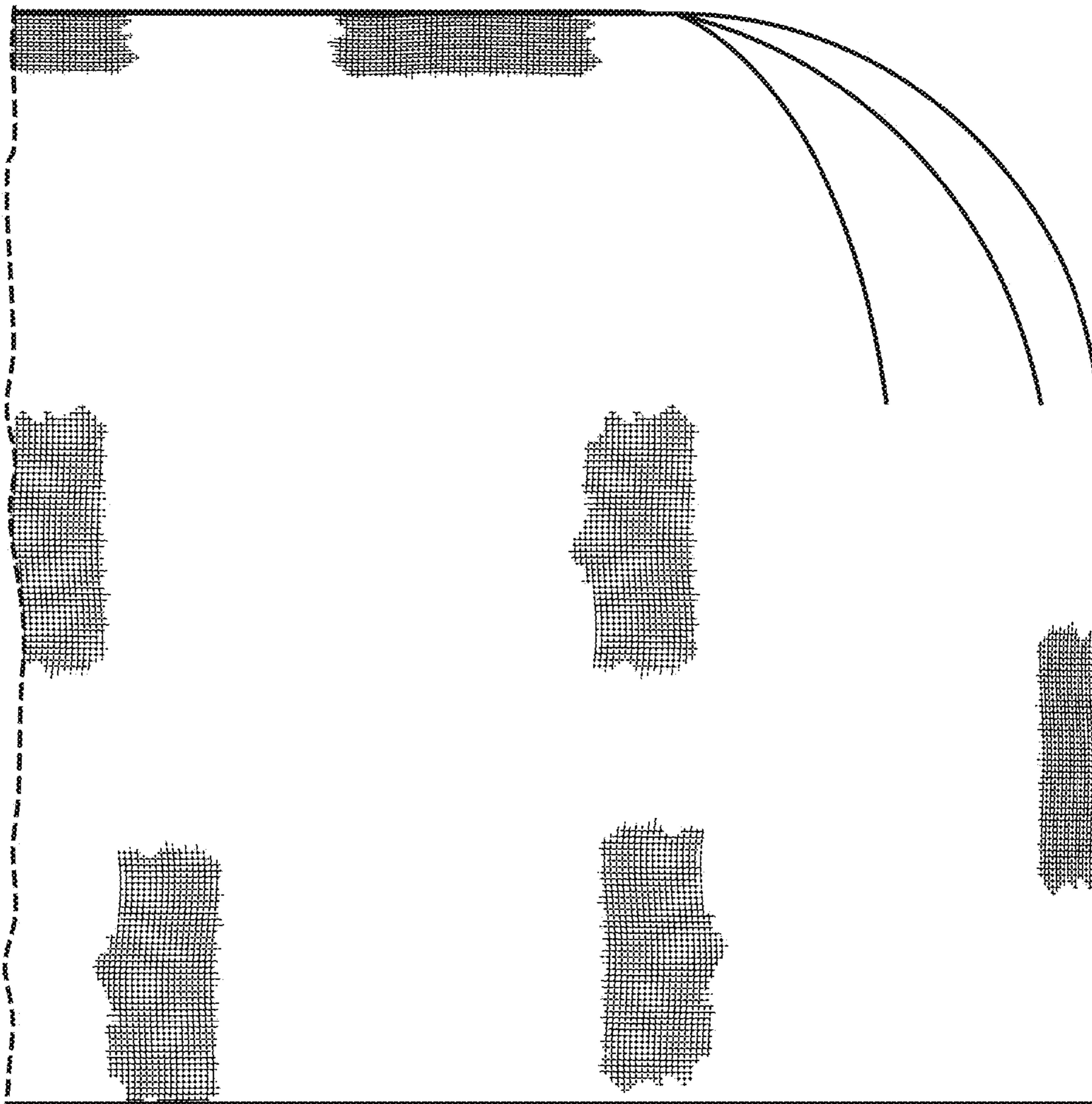

Fig.6

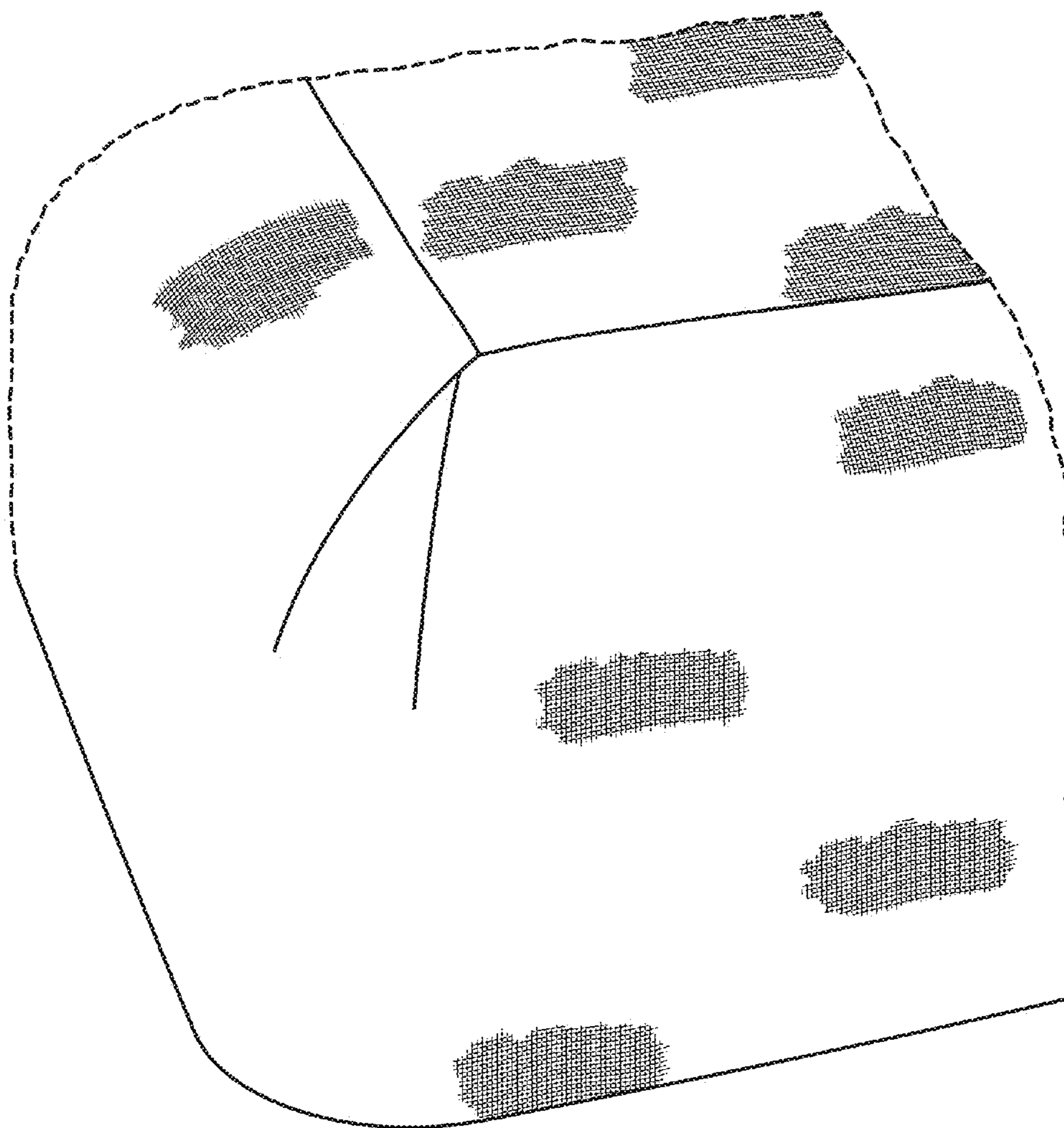

Fig.7

