



US00D753922S

(12) **United States Design Patent**
Jimenez et al.

(10) **Patent No.:** **US D753,922 S**
(45) **Date of Patent:** **** Apr. 19, 2016**

(54) **TOOTHBRUSH**

D285,730 S 9/1986 Bulwick
4,813,928 A 3/1989 Abe et al.
5,066,155 A 11/1991 English et al.

(71) Applicant: **COLGATE-PALMOLIVE COMPANY**, New York, NY (US)

(Continued)

(72) Inventors: **Eduardo Jimenez**, Manalapan, NJ (US);
Robert Moskovich, East Brunswick, NJ (US);
Andreas Wechsler, Zell am See (AT);
Achim Storz, Zell am See (AT)

FOREIGN PATENT DOCUMENTS

AU 722641 5/1997
AU 2007202870 7/2007

(Continued)

(73) Assignee: **COLGATE-PALMOLIVE COMPANY**, New York, NY (US)

OTHER PUBLICATIONS

921 Toothbrush, Chinaboss.com, www.best-b2b.com/usering/764/769-2/adult-toothbrush-021.jpg, downloaded from the Internet Dec. 21, 2011.

(Continued)

(**) Term: **14 Years**

(21) Appl. No.: **29/476,704**

(22) Filed: **Dec. 16, 2013**

Primary Examiner — Robin V. Webster
Assistant Examiner — Lavone D Tabor

(51) **LOC (10) Cl.** **04-02**

(52) **U.S. Cl.**
USPC **D4/104**

(58) **Field of Classification Search**
USPC D4/101, 104–112, 138; 15/110, 167.1,
15/167.2, 207.2; 132/308–311; 601/139,
601/141, 142; 606/161
CPC A46B 3/00; A46B 3/005; A46B 3/02;
A46B 3/04; A46B 3/06; A46B 3/22; A46B
5/02; A46B 5/023; A46B 5/025; A46B 5/026;
A46B 5/028; A46B 9/00; A46B 9/005;
A46B 9/02; A46B 9/04; A46B 9/045; A46B
9/06; A46B 15/0075; A46B 15/0081; A46B
2200/00; A46B 2200/10; A46B 2200/1026;
A46B 2200/1066; A46B 2200/1073; A46B
2200/1086; A61B 17/244

See application file for complete search history.

(56) **References Cited**

U.S. PATENT DOCUMENTS

D200,385 S 2/1965 Tinsley
4,583,563 A 4/1986 Turner

(57) **CLAIM**
The ornamental design for a toothbrush, as shown and described.

DESCRIPTION

FIG. 1 is a front perspective view of a toothbrush according to the new design;
FIG. 2 is a rear perspective view thereof;
FIG. 3 is a front view thereof;
FIG. 4 is a rear view thereof;
FIG. 5 is a left side view thereof;
FIG. 6 is a right side view thereof;
FIG. 7 is a greatly enlarged top view thereof;
FIG. 8 is a greatly enlarged bottom view thereof;
FIG. 9 is an enlarged detail view of area 9 of FIG. 1; and,
FIG. 10 is an enlarged detail view of area 10 of FIG. 3.
The claim consists of the features shown on the front of the head of the toothbrush. The broken lines showing the rest of the head and the handle illustrate portions of the toothbrush that form no part of the claimed design.

1 Claim, 5 Drawing Sheets

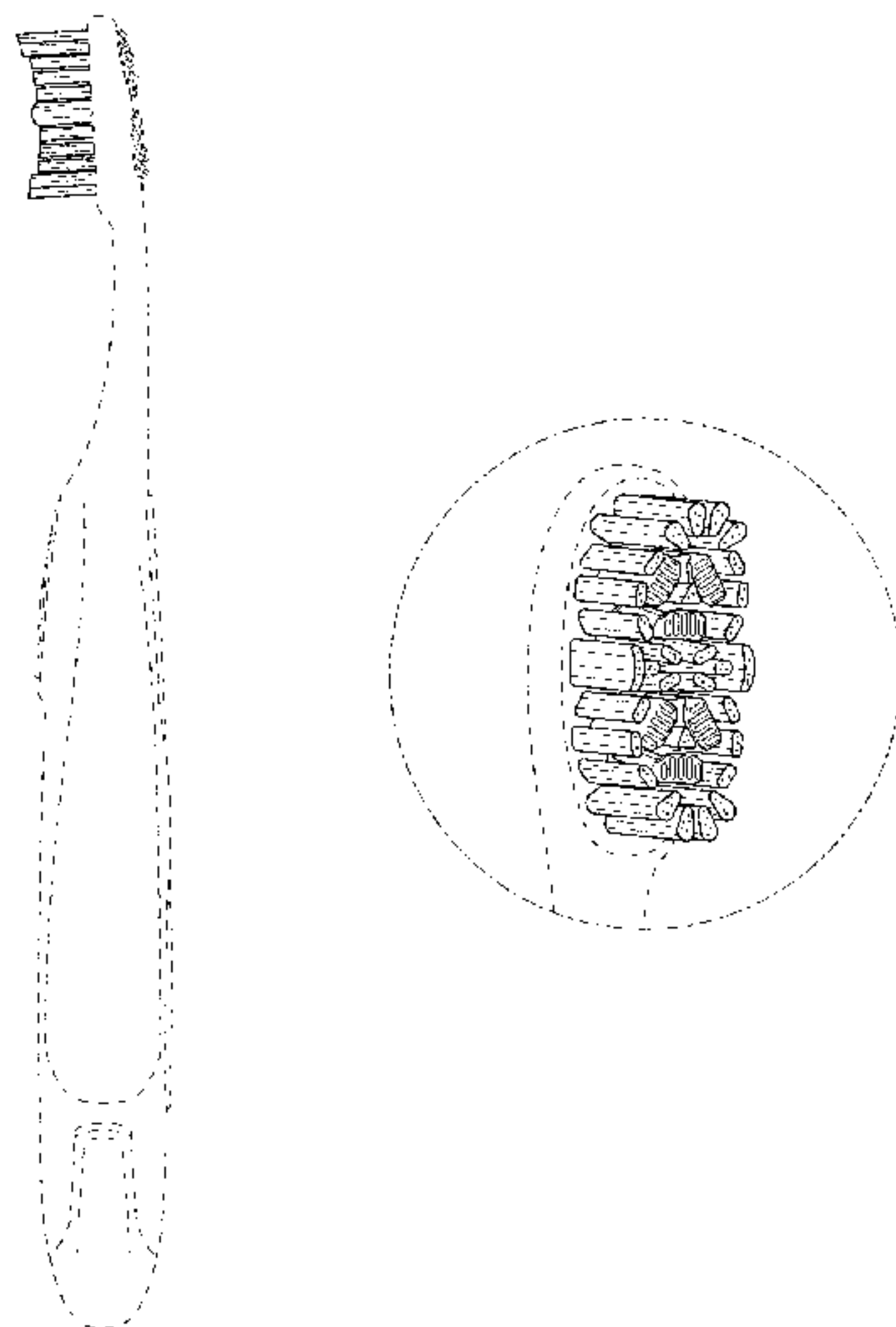

(56)

References Cited

U.S. PATENT DOCUMENTS

D347,944 S 6/1994 Honora
 D378,957 S 4/1997 Turner et al.
 5,799,353 A 9/1998 Oishi et al.
 5,842,487 A 12/1998 Ledet
 5,896,614 A 4/1999 Flewitt
 5,980,542 A 11/1999 Saldivar
 5,985,192 A 11/1999 Weihrauch
 5,987,688 A 11/1999 Roberts et al.
 6,004,334 A 12/1999 Mythen
 D419,775 S 2/2000 Sidhu
 D422,143 S * 4/2000 Beals et al. D4/104
 D437,118 S 2/2001 Cheng
 D440,048 S 4/2001 Beals
 6,213,662 B1 4/2001 Aljanedi
 6,280,113 B1 8/2001 Gueret
 6,299,369 B1 10/2001 Baines et al.
 6,308,367 B1 10/2001 Beals et al.
 6,311,358 B1 11/2001 Soetewey et al.
 D459,585 S 7/2002 Moreno et al.
 6,463,618 B1 10/2002 Zimmer
 6,517,350 B2 2/2003 Diasti et al.
 6,553,604 B1 4/2003 Braun et al.
 D482,200 S 11/2003 Daniels et al.
 6,648,538 B2 11/2003 Gueret
 6,729,789 B2 5/2004 Gordon
 D537,165 S 2/2007 Leite et al.
 7,237,974 B2 7/2007 Pfenniger et al.
 D549,462 S * 8/2007 Blanchard et al. D4/106
 D569,627 S 5/2008 Goldenthal et al.
 D574,617 S 8/2008 Gamez et al.
 D584,512 S 1/2009 Trace
 7,480,955 B2 * 1/2009 Hohlbein et al. 15/111
 7,546,658 B2 6/2009 Koeth et al.
 7,854,036 B2 12/2010 Georgi
 7,878,728 B2 2/2011 Nasu et al.
 7,958,589 B2 6/2011 Braun et al.
 D653,805 S 2/2012 Tani
 D654,695 S 2/2012 Jimenez et al.
 D660,003 S 5/2012 Blanchard et al.
 8,256,979 B2 9/2012 Hilscher et al.
 D669,982 S 10/2012 Ruiz, Sr. et al.
 8,276,233 B2 10/2012 Gavney, Jr. et al.
 8,277,237 B1 10/2012 Cherish
 8,282,303 B2 10/2012 Umeno et al.
 8,328,449 B2 12/2012 Wightman et al.
 8,333,525 B2 12/2012 Wightman et al.
 D675,024 S 1/2013 Blanchard et al.
 8,387,628 B2 3/2013 Bowie
 8,464,914 B2 6/2013 Lulla et al.
 8,496,393 B2 7/2013 Martin et al.
 8,500,352 B1 8/2013 Messersmith et al.
 8,511,323 B2 8/2013 Jimenez et al.
 8,523,475 B2 9/2013 Jimenez et al.
 8,528,145 B2 9/2013 Boyd et al.
 8,528,736 B2 9/2013 Teys et al.
 8,544,684 B2 10/2013 Perez
 8,636,433 B2 1/2014 Lerner et al.
 2004/0255416 A1 12/2004 Hohlbein
 2006/0107478 A1 * 5/2006 Boucherie 15/167.1
 2006/0222683 A1 10/2006 Mythen
 2007/0283518 A1 12/2007 Blanchard et al.
 2008/0205970 A1 8/2008 LaFlamme et al.
 2009/0025162 A1 1/2009 Chan et al.
 2009/0119859 A1 5/2009 Podolsky
 2009/0183324 A1 7/2009 Fischer et al.
 2009/0183331 A1 7/2009 Gross et al.
 2009/0229063 A1 9/2009 Merl et al.
 2009/0297253 A1 12/2009 Yuu
 2010/0296859 A1 11/2010 Lerner et al.
 2011/0047736 A1 3/2011 Jimenez et al.
 2011/0308029 A1 12/2011 Edelstein et al.
 2011/0308030 A1 12/2011 Jimenez et al.
 2011/0314623 A1 12/2011 Jimenez et al.
 2011/0315719 A1 12/2011 Tani
 2012/0034016 A1 2/2012 Jimenez et al.

2012/0039661 A1 2/2012 Fukumoto et al.
 2012/0077145 A1 3/2012 Tsurukawa et al.
 2012/0103355 A1 5/2012 Bowie
 2012/0114410 A1 5/2012 Jimenez et al.
 2012/0128402 A1 5/2012 Wightman et al.
 2012/0144612 A1 6/2012 Chen
 2012/0163902 A1 6/2012 Jimenez et al.
 2012/0205393 A1 8/2012 Perez
 2012/0244491 A1 9/2012 Piergallini et al.
 2012/0248152 A1 10/2012 Weill et al.
 2012/0251981 A1 10/2012 Piergallini et al.
 2012/0257920 A1 10/2012 Jimenez et al.
 2012/0266400 A1 10/2012 Jimenez et al.
 2012/0272996 A1 11/2012 Jimenez et al.
 2012/0275841 A1 11/2012 Jimenez et al.
 2012/0275843 A1 11/2012 Jimenez et al.
 2012/0284945 A1 11/2012 Lotscher et al.
 2012/0291910 A1 11/2012 Wightman et al.
 2012/0301209 A1 11/2012 Fattori
 2013/0092709 A1 4/2013 Salem et al.
 2013/0175300 A1 7/2013 Gyakushi et al.
 2013/0205524 A1 8/2013 Dhami
 2013/0245597 A1 9/2013 Johnson et al.
 2013/0255021 A1 10/2013 Xi et al.
 2013/0316300 A1 11/2013 Jimenez et al.

FOREIGN PATENT DOCUMENTS

AU 2008200508 2/2008
 AU 2010202358 7/2010
 AU 2011218764 9/2011
 CA 2394842 6/2001
 CN 1415258 5/2003
 CN 201108158 9/2008
 CN 300882113 2/2009
 CN 201263448 7/2009
 CN 201324009 10/2009
 CN 201814078 5/2011
 CN 301548742 5/2011
 CN 202085945 12/2011
 CN 202146041 2/2012
 CN 301961506 6/2012
 CN 202341227 7/2012
 CN 202341228 7/2012
 CN 202407679 9/2012
 CN 202536513 11/2012
 CN 202536517 11/2012
 CN 202552703 11/2012
 CN 202552709 11/2012
 CN 202588734 12/2012
 CN 202636032 1/2013
 CN 202664665 1/2013
 CN 202820091 3/2013
 CN 202820120 3/2013
 CN 302387323 4/2013
 CN 302448423 6/2013
 CN 302471528 6/2013
 DE 202005009026 11/2005
 DE 202012004274 U1 * 8/2012 A46B 9/04
 EM 000158332-0002 7/2004
 EM 000158332-0003 7/2004
 EM 000466164-0001 3/2006
 EM 000552989-0001 8/2006
 EM 000552989-0002 8/2006
 EM 001227524-0001 9/2010
 EM 001823311-0001 3/2011
 EM 002270710-0001 7/2013
 EP 1 661 487 5/2006
 EP 2 060 201 5/2009
 EP 2 404 524 1/2012
 EP 2 008 545 8/2013
 GB 2 451 230 1/2009
 IN D214333 1/2008
 IN D219495 10/2008
 IN D219496 10/2008
 IN D231307 9/2010
 JP 3046561 5/2000
 JP 3311991 8/2002
 JP 2002-360342 12/2002

(56)

References Cited

FOREIGN PATENT DOCUMENTS

| | | |
|----|----------------|---------|
| JP | 3794108 | 7/2006 |
| JP | 2008-029397 | 2/2008 |
| JP | 2008-055233 | 3/2008 |
| JP | 4076403 | 4/2008 |
| JP | 4076404 | 4/2008 |
| JP | 4076405 | 4/2008 |
| JP | 4076412 | 4/2008 |
| JP | 2008-142371 | 6/2008 |
| JP | 4187483 | 11/2008 |
| JP | 4187489 | 11/2008 |
| JP | 4301380 | 7/2009 |
| JP | 4316487 | 8/2009 |
| JP | 2009-273760 | 11/2009 |
| JP | 2010-158591 | 7/2010 |
| JP | 4515714 | 8/2010 |
| JP | 4541874 | 9/2010 |
| JP | 4570293 | 10/2010 |
| KR | 30-0362655 S * | 9/2004 |
| KR | 30-0682280 S * | 2/2013 |
| RU | 2143388 | 12/1999 |
| RU | D55985 | 1/2005 |
| RU | 2250185 | 4/2005 |
| RU | 82113 | 4/2009 |
| RU | 87330 | 10/2009 |
| RU | 2400119 | 9/2010 |

| | | |
|----|--------------------|-------------------------|
| RU | 100370 | 12/2010 |
| RU | D78891 | 7/2011 |
| RU | D84563 | 3/2013 |
| RU | D85378 | 6/2013 |
| WO | WO 99/58019 | 11/1999 |
| WO | WO 00/64307 | 11/2000 |
| WO | WO 03/055351 | 7/2003 |
| WO | WO 2004/071237 | 8/2004 |
| WO | WO 2004/082428 | 9/2004 |
| WO | WO 2006/058969 | 8/2006 |
| WO | WO 2007/063775 | 6/2007 |
| WO | WO 2008/104507 | 9/2008 |
| WO | WO 2010/144938 | 12/2010 |
| WO | WO 2011/079029 | 6/2011 |
| WO | WO 2012/099230 | 7/2012 |
| WO | WO 2013/005034 | 1/2013 |
| WO | WO 2013095452 A1 * | 6/2013 A46B 9/005 |

OTHER PUBLICATIONS

Fresh Breath 400 TC Toothbrush, <https://secure.jnjcanada.com/reach/en/products.asp>, downloaded from the Internet Dec. 2, 2011.

S803 Toothbrush, Chinaboss.com, www.supplierlist.com/photo_images/65486/Adult_Toothbrush_S803with_tongue_cleaner.jpg, downloaded from the Internet Dec. 2, 2011.

Tongue Cleaner 2011. S535, www.chinaboss.com, downloaded from the Internet Dec. 2, 2011.

* cited by examiner

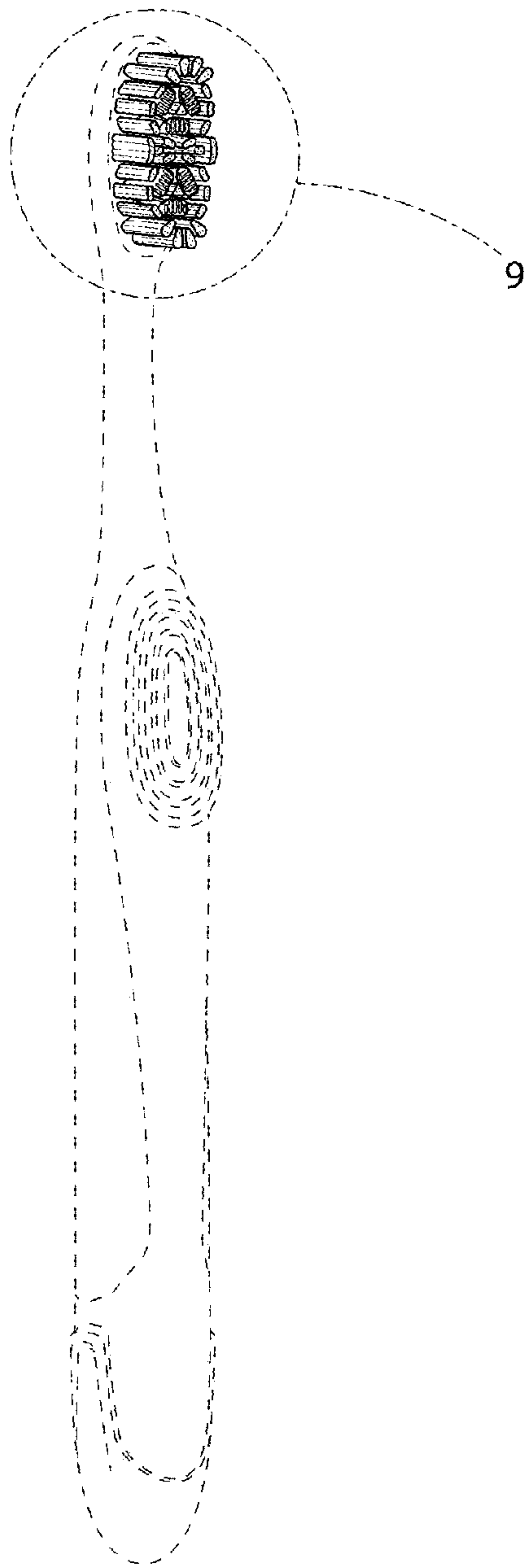

FIG. 1

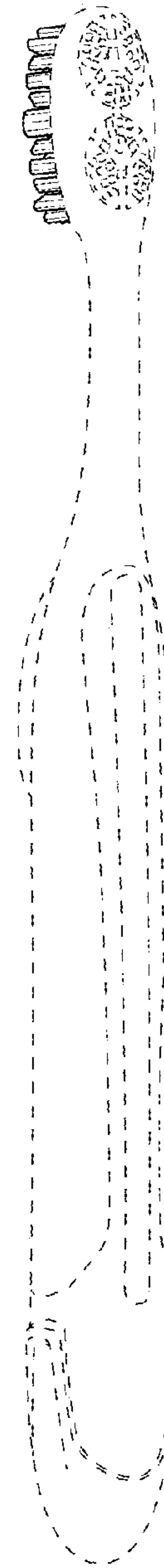

FIG. 2

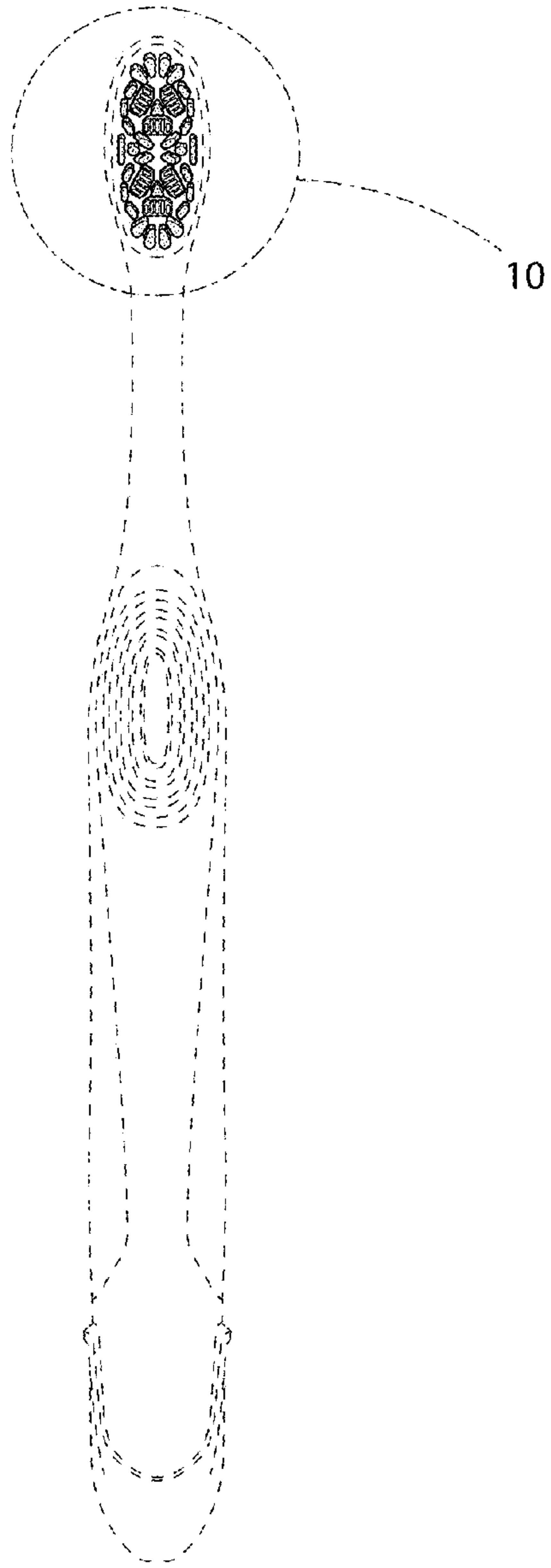

FIG. 3

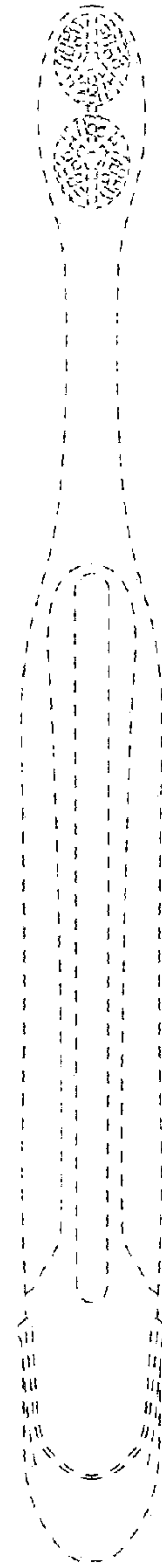

FIG. 4

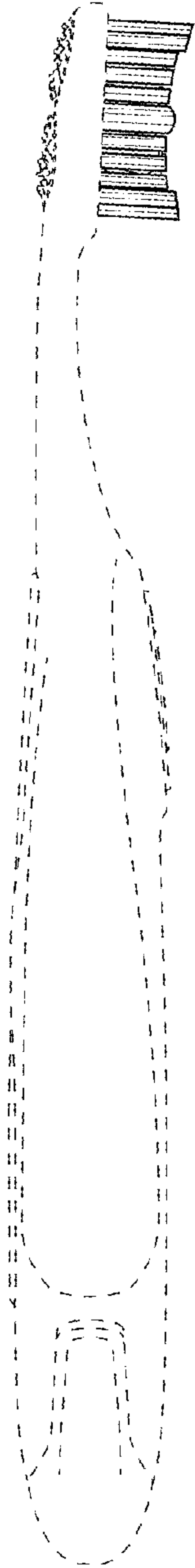

FIG. 5

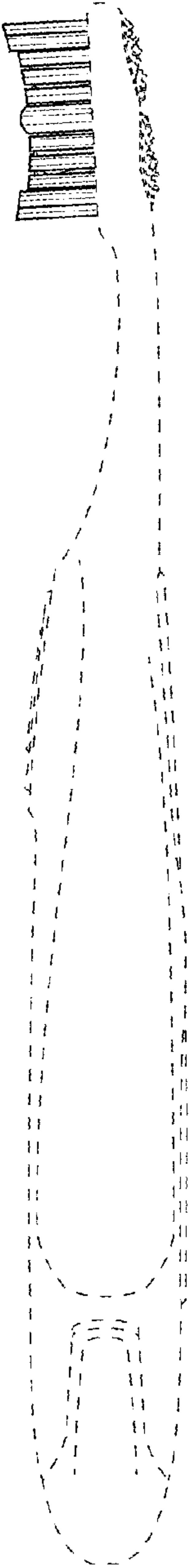

FIG. 6

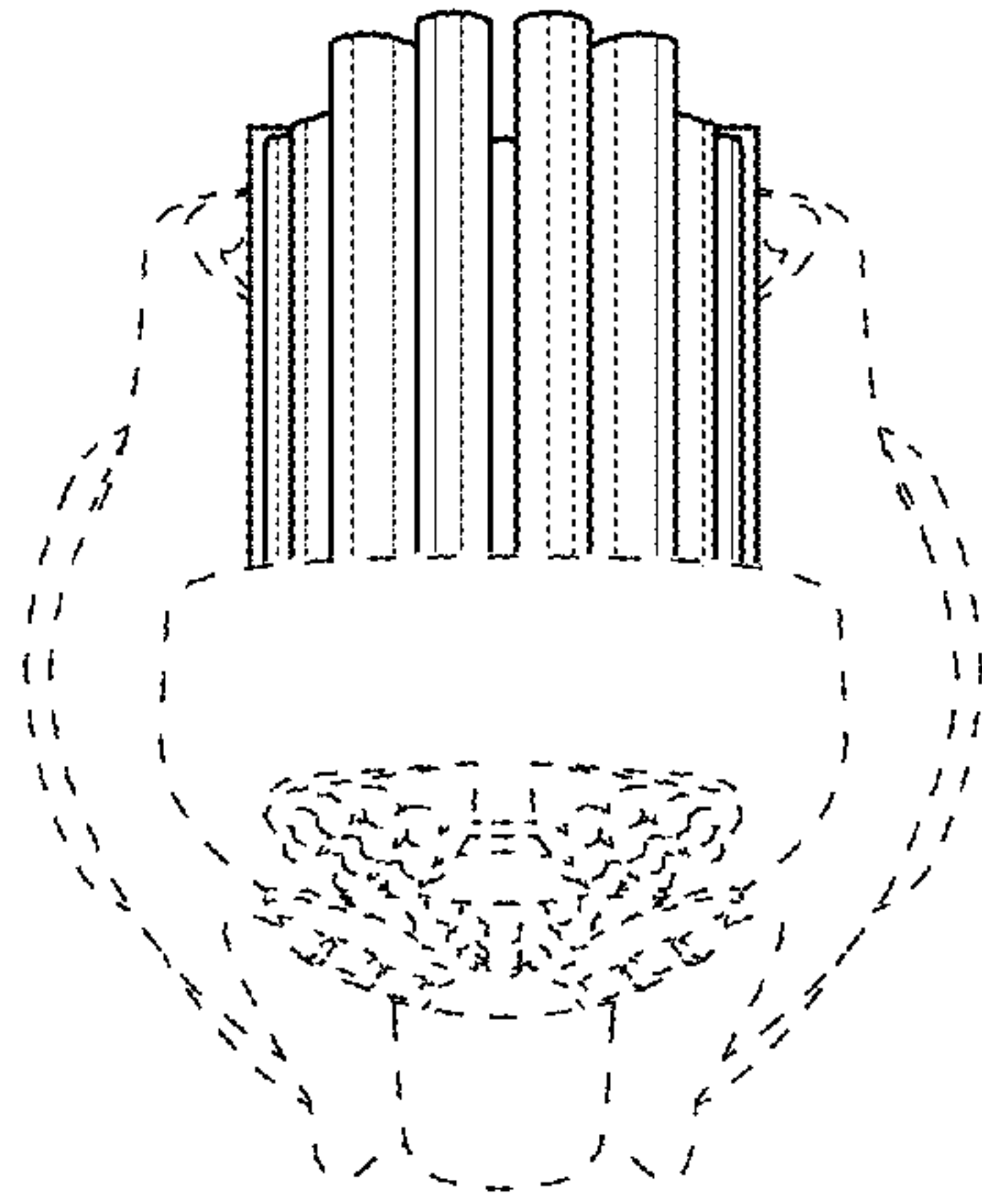

FIG. 7

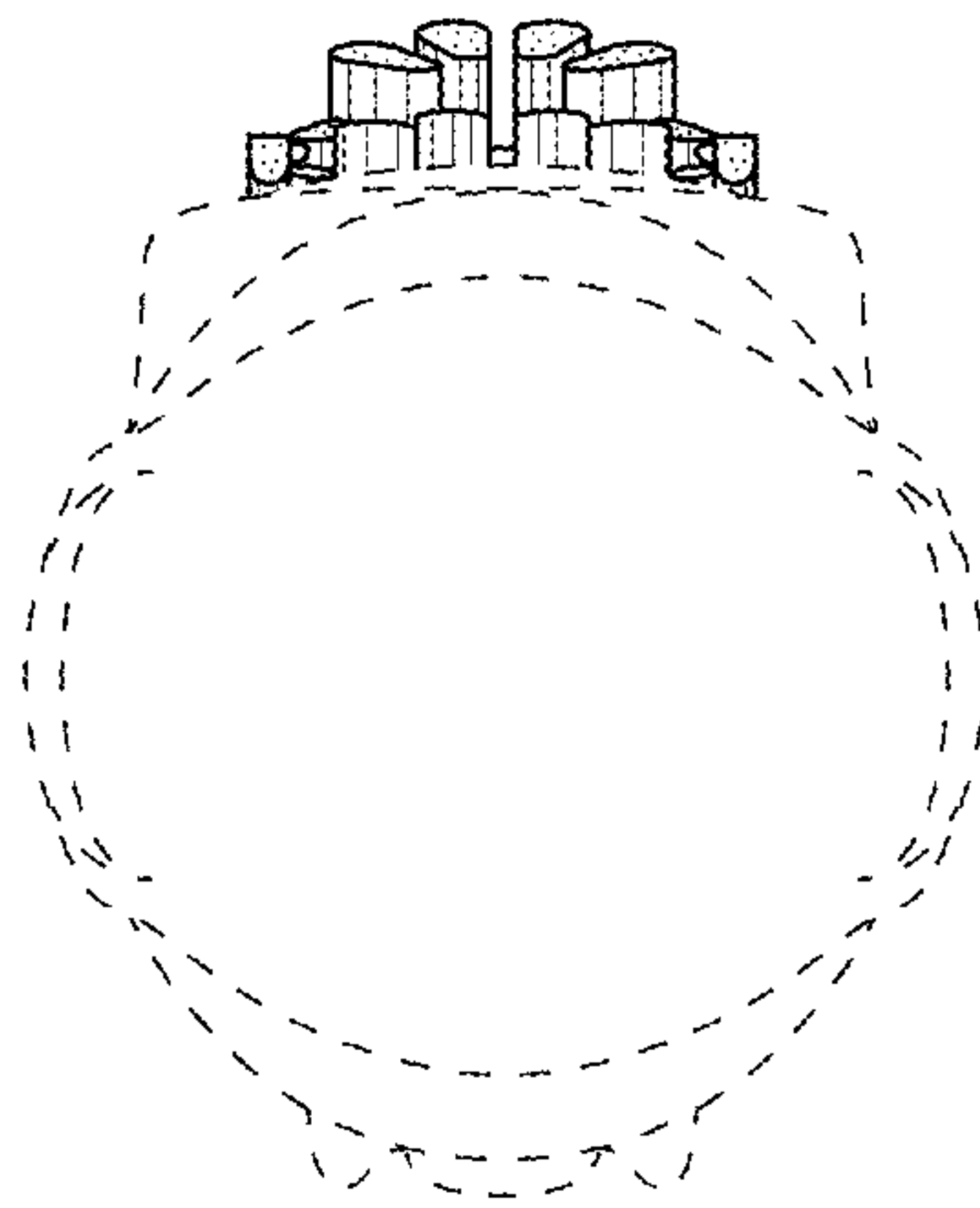

FIG. 8

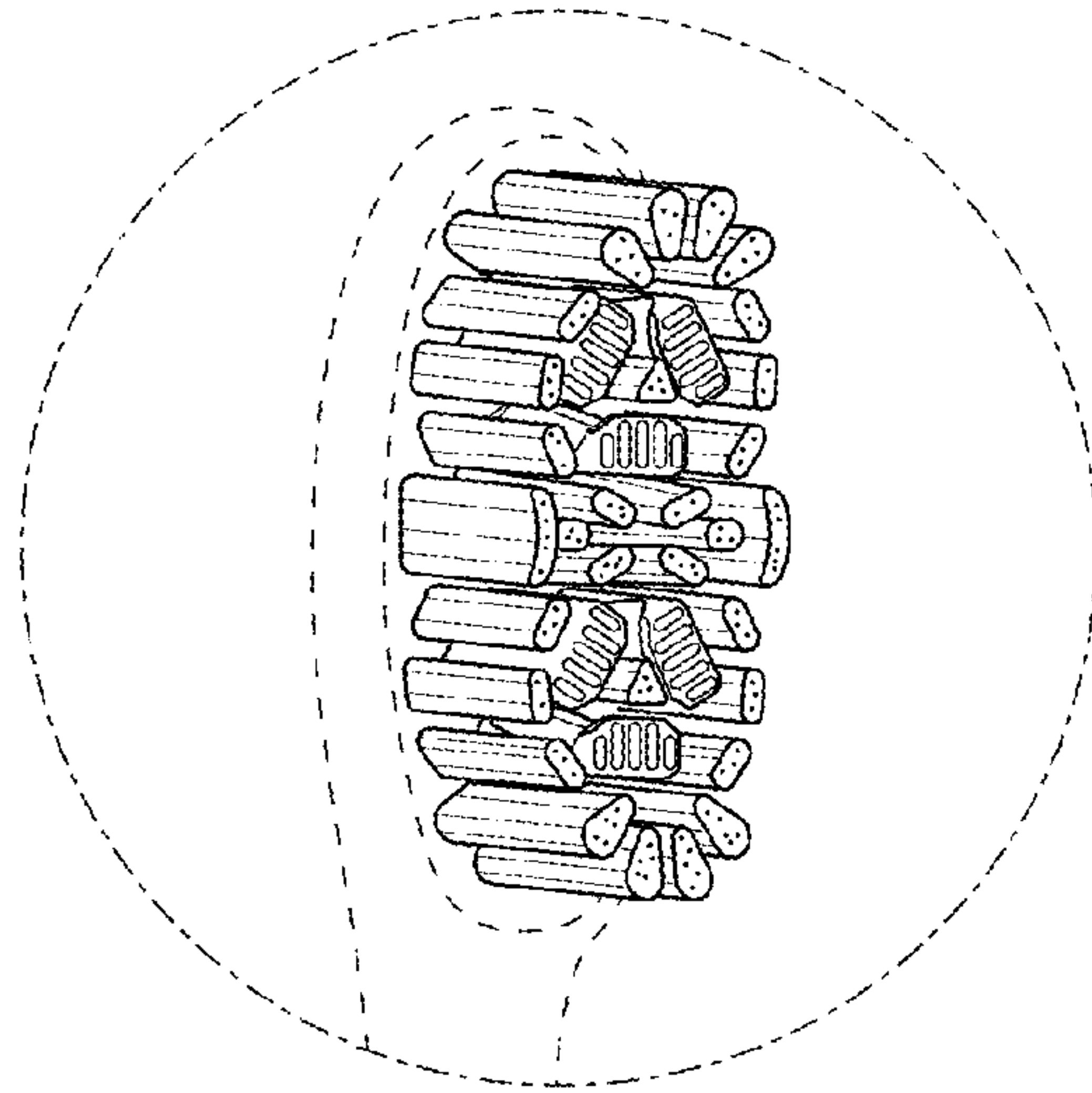

FIG. 9

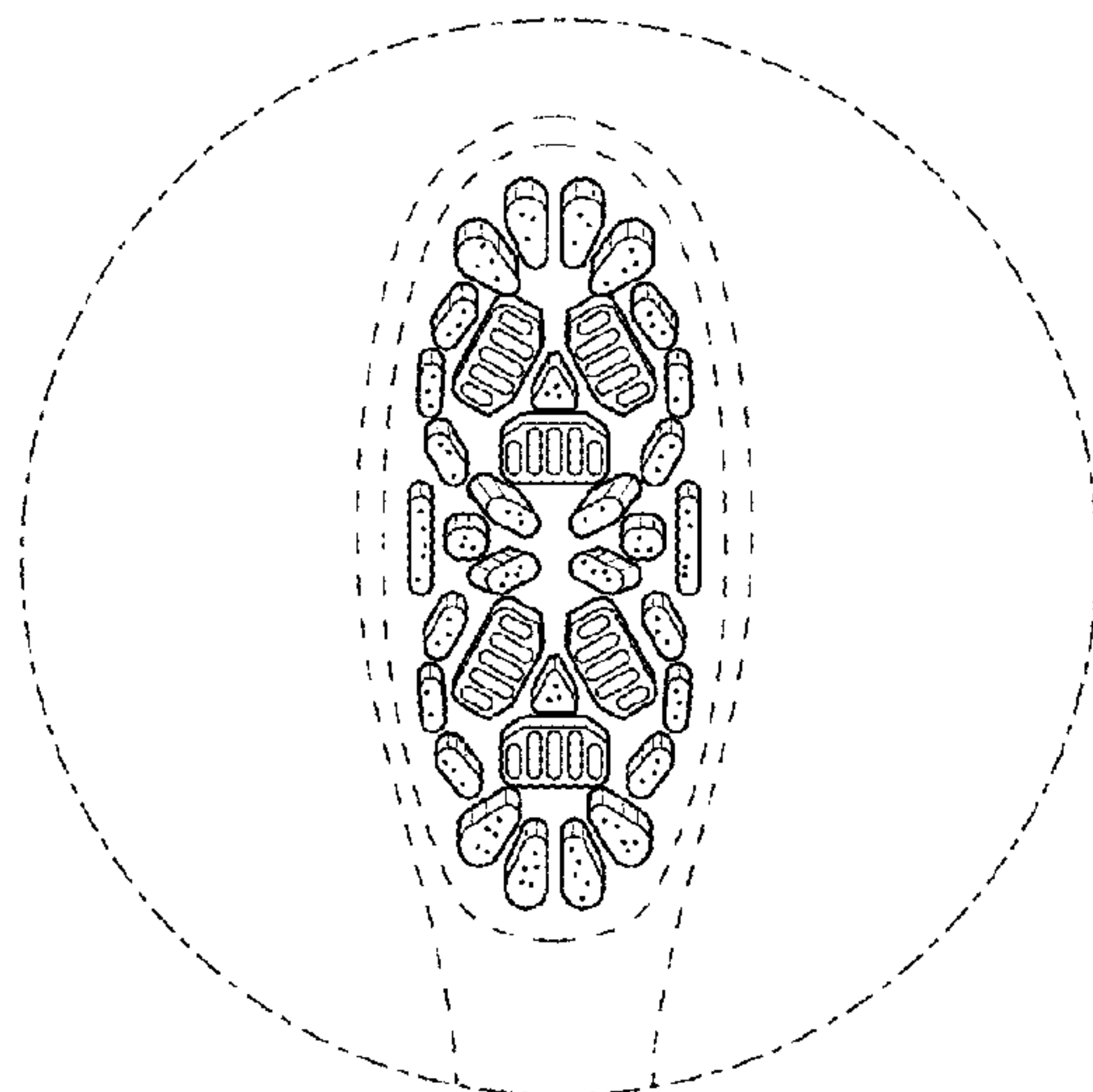

FIG. 10