



US00D753797S

(12) **United States Design Patent**
Suematsu et al.

(10) **Patent No.:** **US D753,797 S**
(45) **Date of Patent:** **** Apr. 12, 2016**

(54) **ELECTROMAGNETIC VALVE**

(71) Applicant: **CKD Corporation**, Aichi (JP)

(72) Inventors: **Osamu Suematsu**, Komaki (JP); **Akira Kishi**, Komaki (JP)

(73) Assignee: **CKD Corporation**, Aichi (JP)

(**) Term: **14 Years**

(21) Appl. No.: **29/518,557**

(22) Filed: **Feb. 25, 2015**

(30) **Foreign Application Priority Data**

Aug. 28, 2014 (JP) 2014-018868

(51) **LOC (10) Cl.** **23-01**

(52) **U.S. Cl.**
USPC **D23/233**

(58) **Field of Classification Search**
USPC D23/233-250; 137/625.64, 554, 487.5,
137/599, 557, 560, 882, 884, 343, 269,
137/129.01, 129.15; 251/129.15, 129.01
CPC ... F16K 31/0675; F16K 27/029; F16K 31/02;
F16K 31/082; F16K 27/048; F16K 11/24
See application file for complete search history.

(56) **References Cited**

U.S. PATENT DOCUMENTS

D416,309 S * 11/1999 Hayashi D23/233
D419,216 S * 1/2000 Sato D23/233
D460,148 S * 7/2002 Hayashi D23/233

D533,254 S * 12/2006 Miyazoe D23/233
7,316,244 B2 * 1/2008 Miyazoe F15B 13/0817
137/271
D638,101 S * 5/2011 Kato D23/233
D720,043 S * 12/2014 Nishiyama D23/233
D720,046 S * 12/2014 Morodomi D23/233
D736,889 S * 8/2015 Nishiyama D23/233
D736,894 S * 8/2015 Morodomi D23/233

* cited by examiner

Primary Examiner — Cynthia Ramirez

Assistant Examiner — Gino Colan

(74) *Attorney, Agent, or Firm* — Kilpatrick Townsend & Stockton LLP

(57) **CLAIM**

The ornamental design for an electromagnetic valve, as shown and described.

DESCRIPTION

FIG. 1 is a front, top, and right side perspective view of an electromagnetic valve showing our new design; FIG. 2 is a rear, bottom, and left side perspective view thereof; FIG. 3 is a front view thereof; FIG. 4 is a rear view thereof; FIG. 5 is a top plan view thereof; FIG. 6 is a bottom plan view thereof; FIG. 7 is a right side view thereof; and, FIG. 8 is a left side view thereof. The features shown in broken lines in the drawings depict environmental subject matter only and form no part of the claimed design.

1 Claim, 8 Drawing Sheets

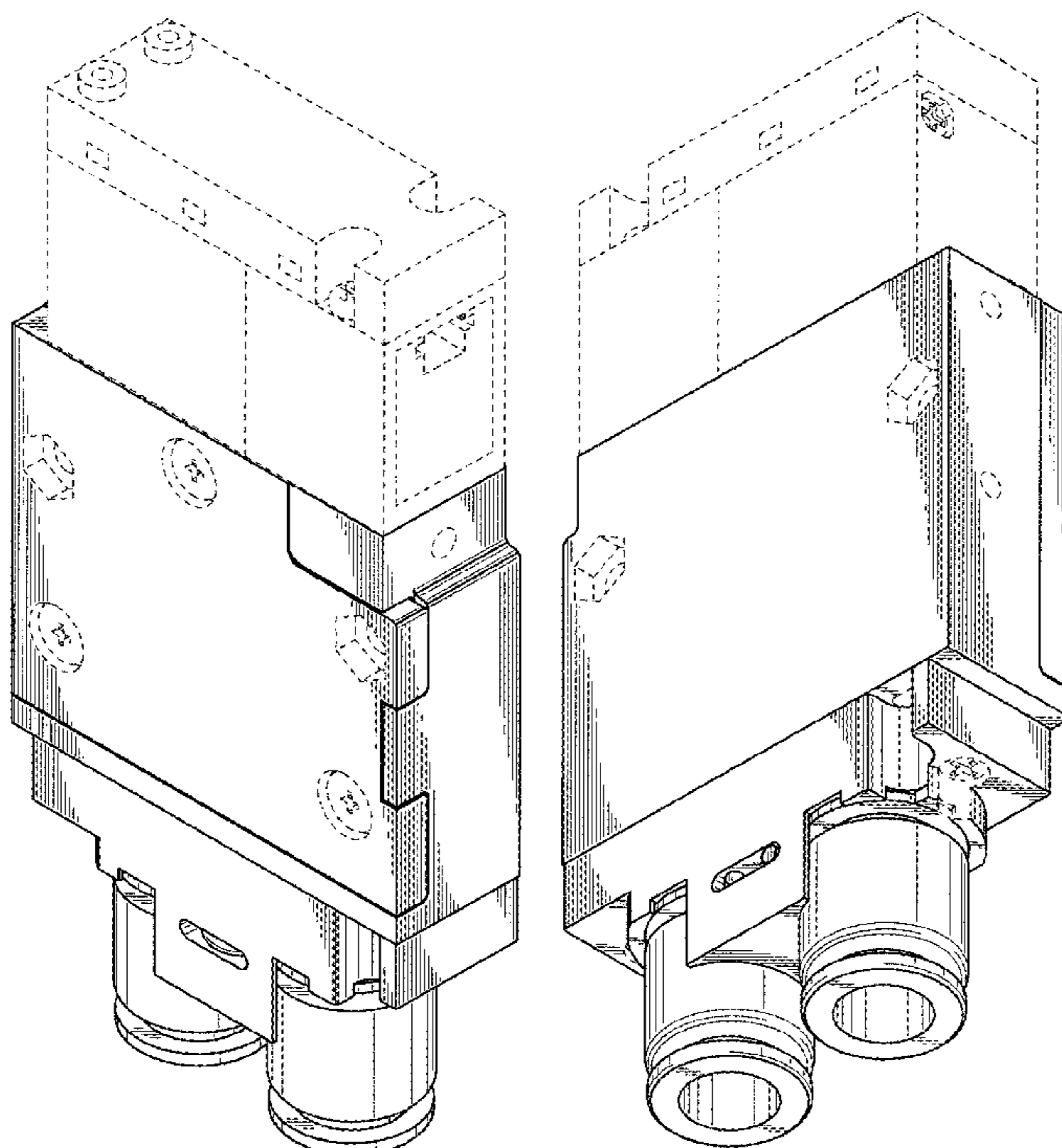

FIG. 1

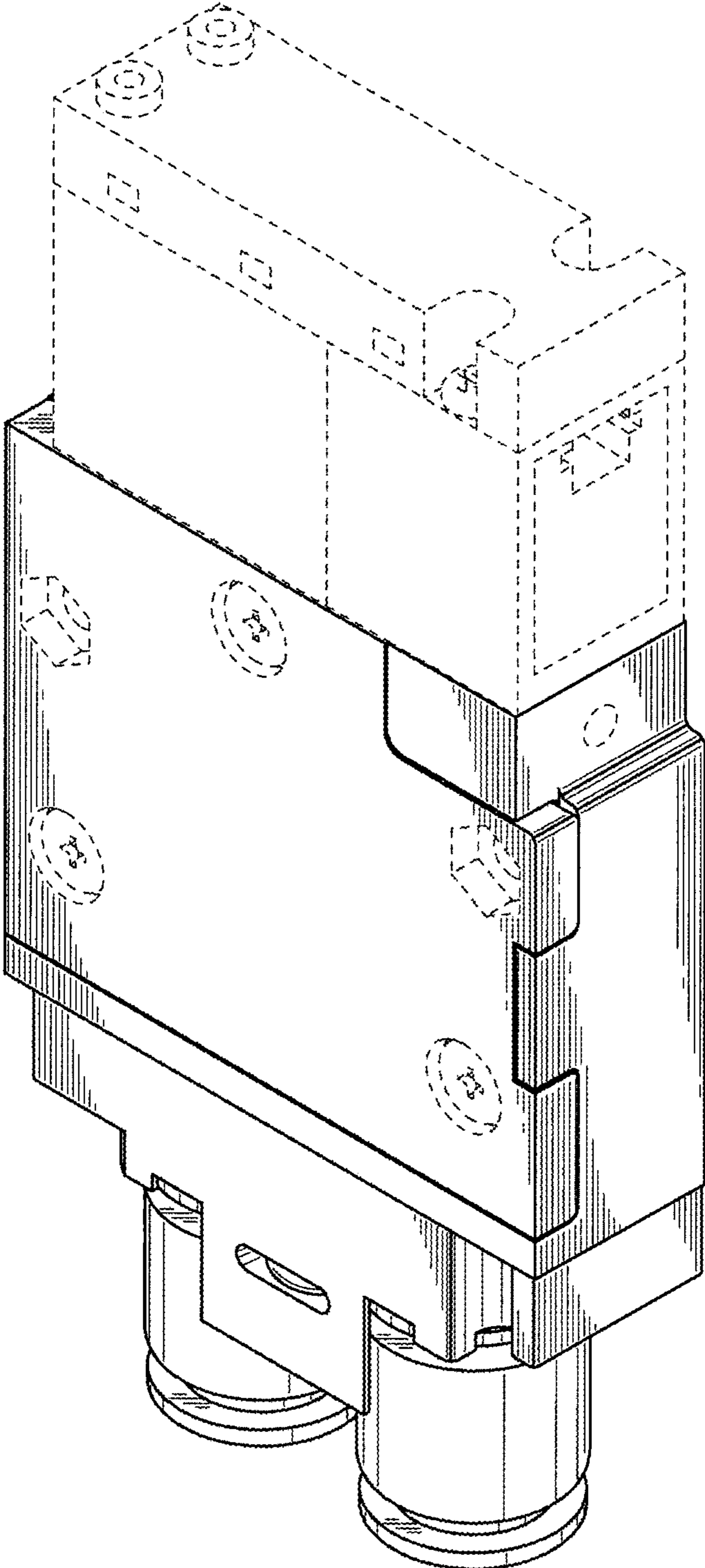

FIG. 2

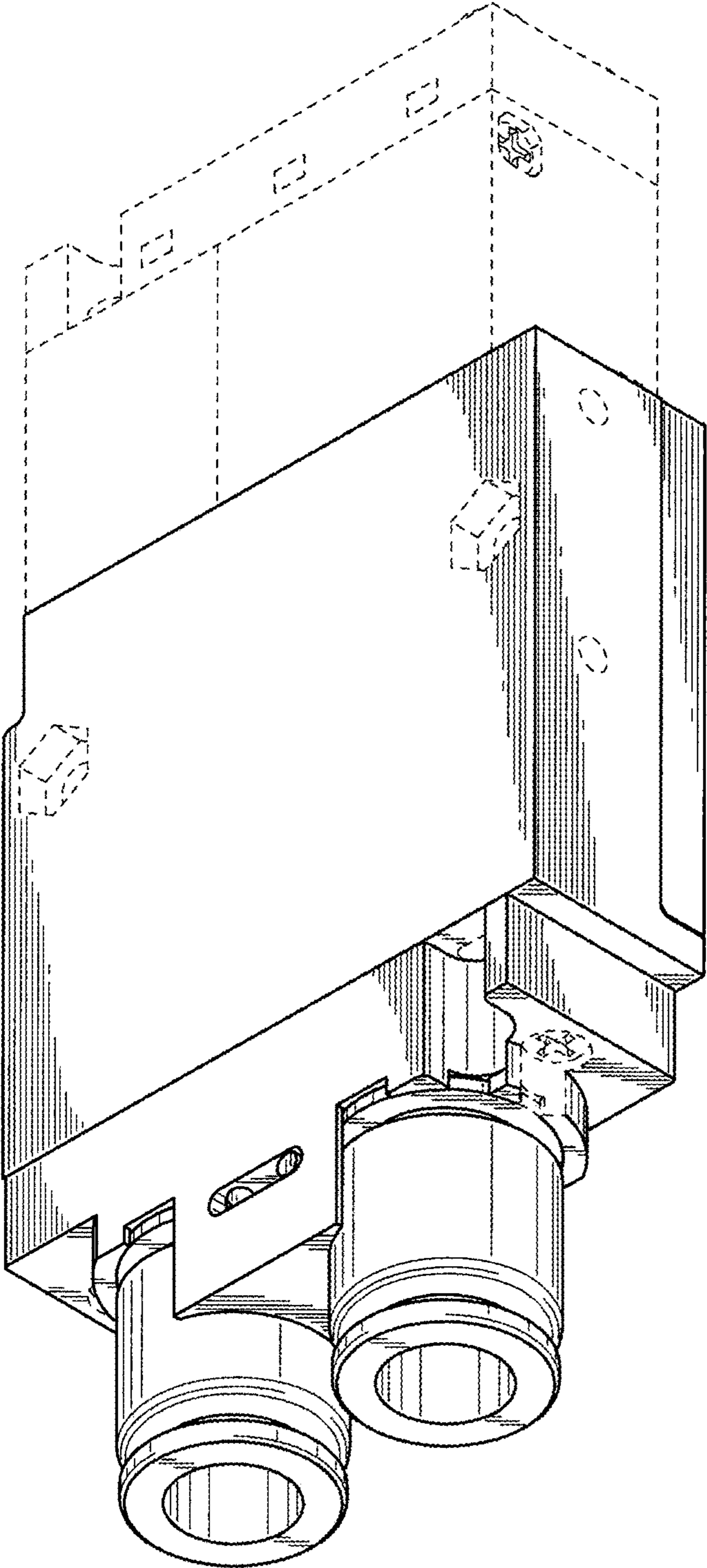

FIG. 3

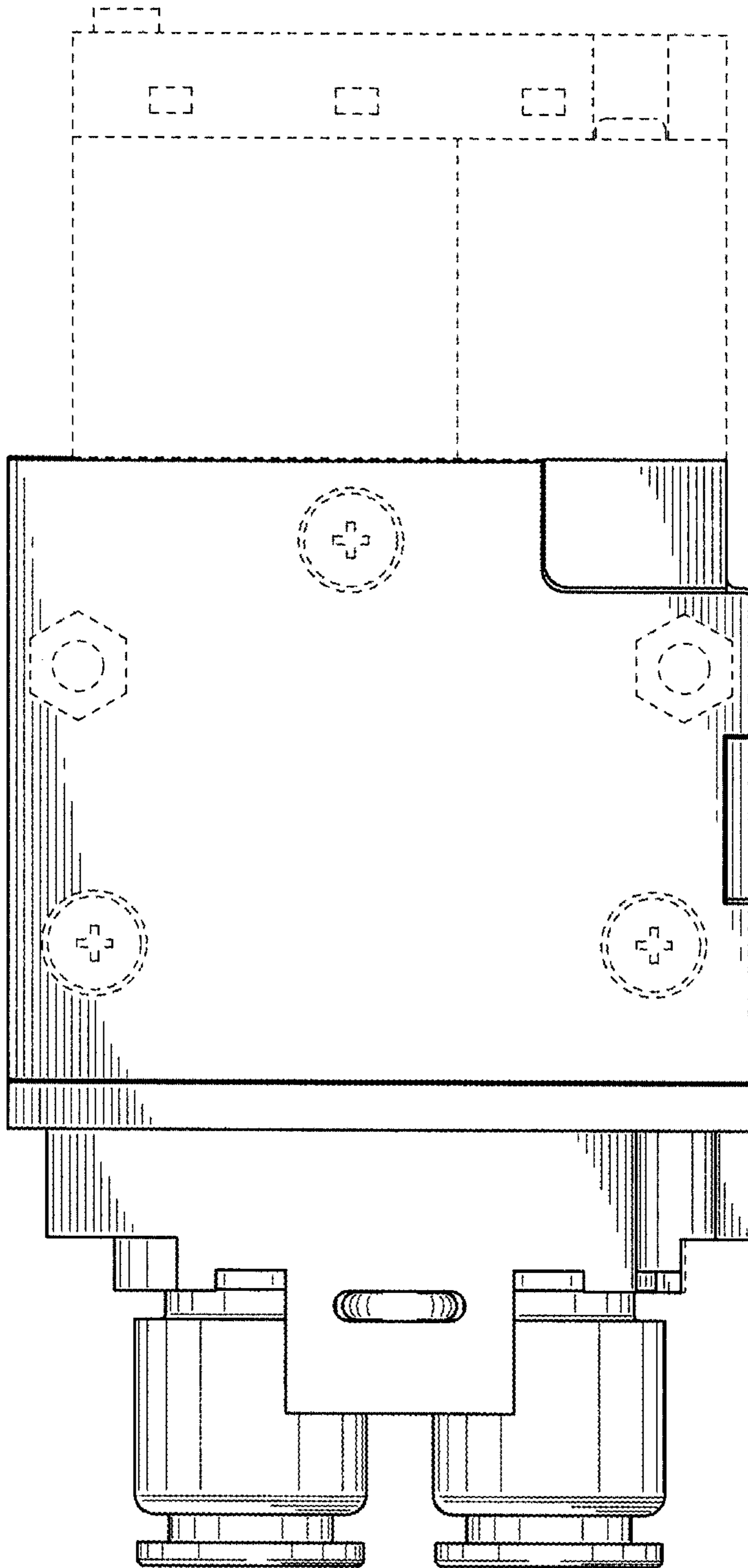

FIG. 4

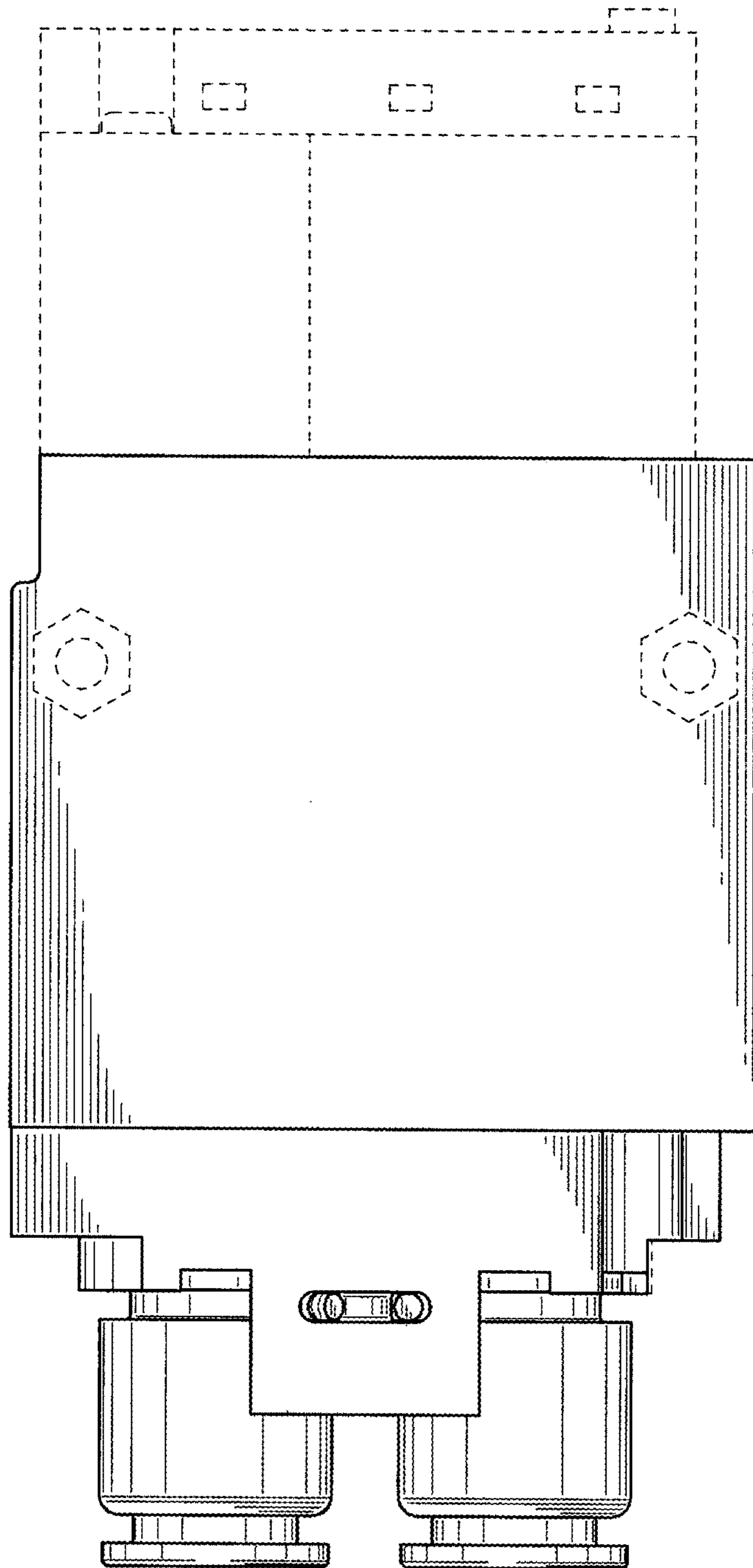

FIG. 5

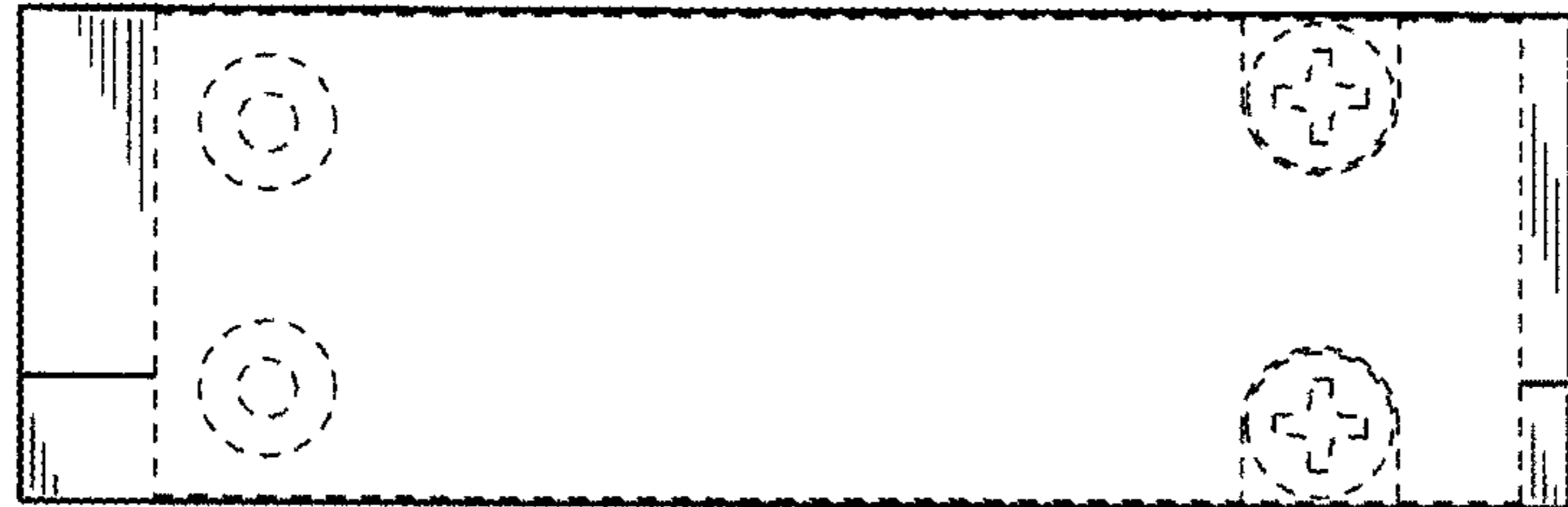

FIG. 6

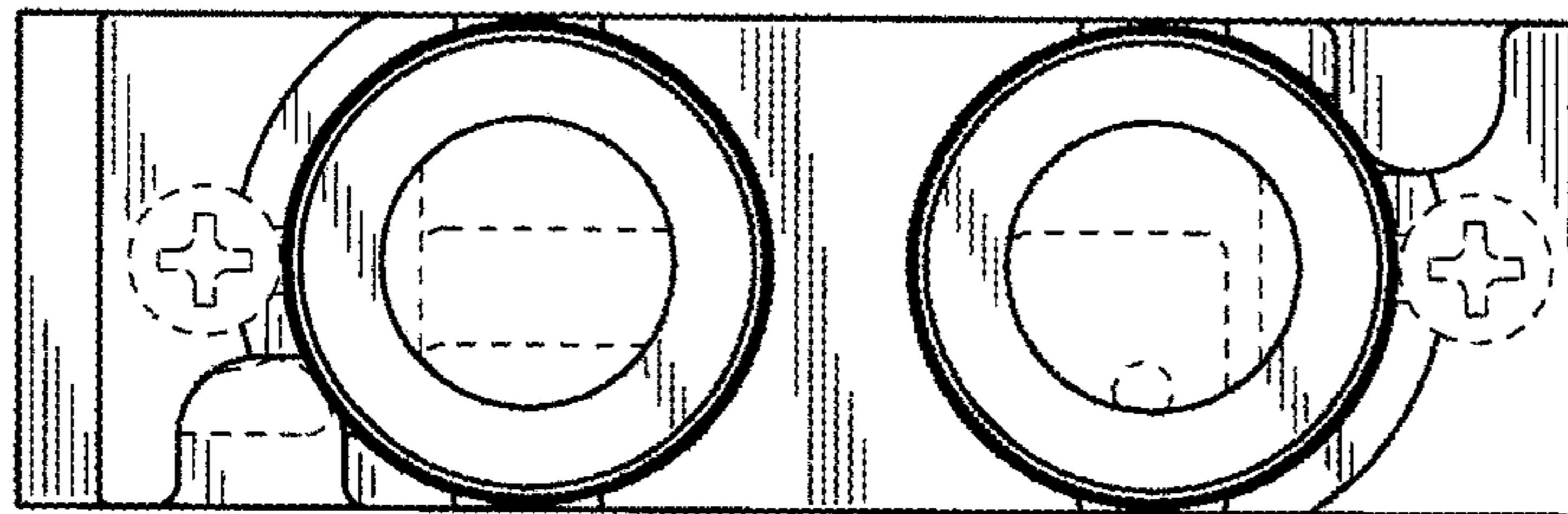

FIG. 7

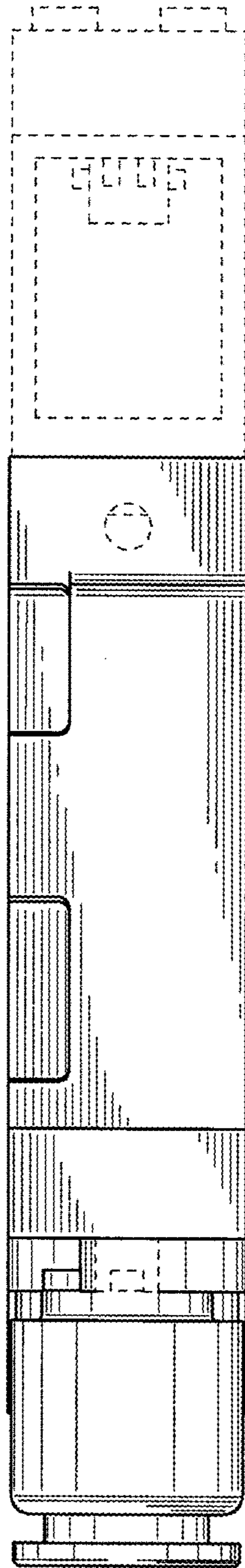

FIG. 8

