



US00D753782S

(12) **United States Design Patent**
Vazquez et al.

(10) **Patent No.:** **US D753,782 S**
(45) **Date of Patent:** **** Apr. 12, 2016**

- (54) **FIREARM BUTTSTOCK**
- (71) Applicant: **TROY INDUSTRIES, INC.**, West
Springfield, MA (US)
- (72) Inventors: **Angela Vazquez**, Westfield, MA (US);
Stephen P. Troy, West Springfield, MA
(US)
- (73) Assignee: **Troy Industries, Inc.**, West Springfield,
MA (US)
- (**) Term: **14 Years**
- (21) Appl. No.: **29/503,716**
- (22) Filed: **Sep. 29, 2014**
- (51) **LOC (10) Cl.** **22-01**
- (52) **U.S. Cl.**
USPC **D22/108**
- (58) **Field of Classification Search**
USPC D22/103, 108; D21/572-573
CPC F41C 23/04; F41C 23/14; F41C 23/06;
F41C 23/22; F41C 33/007
See application file for complete search history.

D728,724 S *	5/2015	Bosco	D22/108
D731,023 S *	6/2015	Hirt	D22/108
2011/0192067 A1 *	8/2011	Troy	F41C 23/20 42/73
2013/0263489 A1 *	10/2013	Troy	F41C 23/22 42/71.01
2014/0260946 A1 *	9/2014	Gomez	F41A 5/18 89/191.01
2015/0176944 A1 *	6/2015	Kupanoff	F41C 23/12 42/73

* cited by examiner

Primary Examiner — Michael A Pratt

(74) *Attorney, Agent, or Firm* — Grossman, Tucker,
Perreault & Pfleger, PLLC

(57) **CLAIM**

The ornamental design for a firearm buttstock, as shown.

DESCRIPTION

FIG. 1 is a front isometric view of the firearm buttstock;
FIG. 2 is a rear isometric view of the firearm buttstock of FIG. 1;
FIG. 3 is a front view of the firearm buttstock of FIG. 1;
FIG. 4 is a rear view of the firearm buttstock of FIG. 1;
FIG. 5 is a left side view of the firearm buttstock of FIG. 1;
FIG. 6 is a right side view of the firearm buttstock of FIG. 1;
FIG. 7 is a top view of the firearm buttstock of FIG. 1;
FIG. 8 is a bottom view of the firearm buttstock of FIG. 1; and,
FIG. 9 is a right side view of the firearm buttstock of FIG. 1
attached to a firearm in the form of a rifle.
Portions of the firearm buttstock shown in broken lines in
FIGS. 1-8, as well as the firearm shown in broken lines in FIG.
9, form no part of the claimed design.

1 Claim, 9 Drawing Sheets

(56) **References Cited**

U.S. PATENT DOCUMENTS

8,756,849 B2 *	6/2014	Troy	F41C 23/06 42/71.01
8,800,190 B1 *	8/2014	Wilde	F41G 1/06 42/71.01
D724,168 S *	3/2015	Alis	D22/103
D725,219 S *	3/2015	Hirt	D22/108

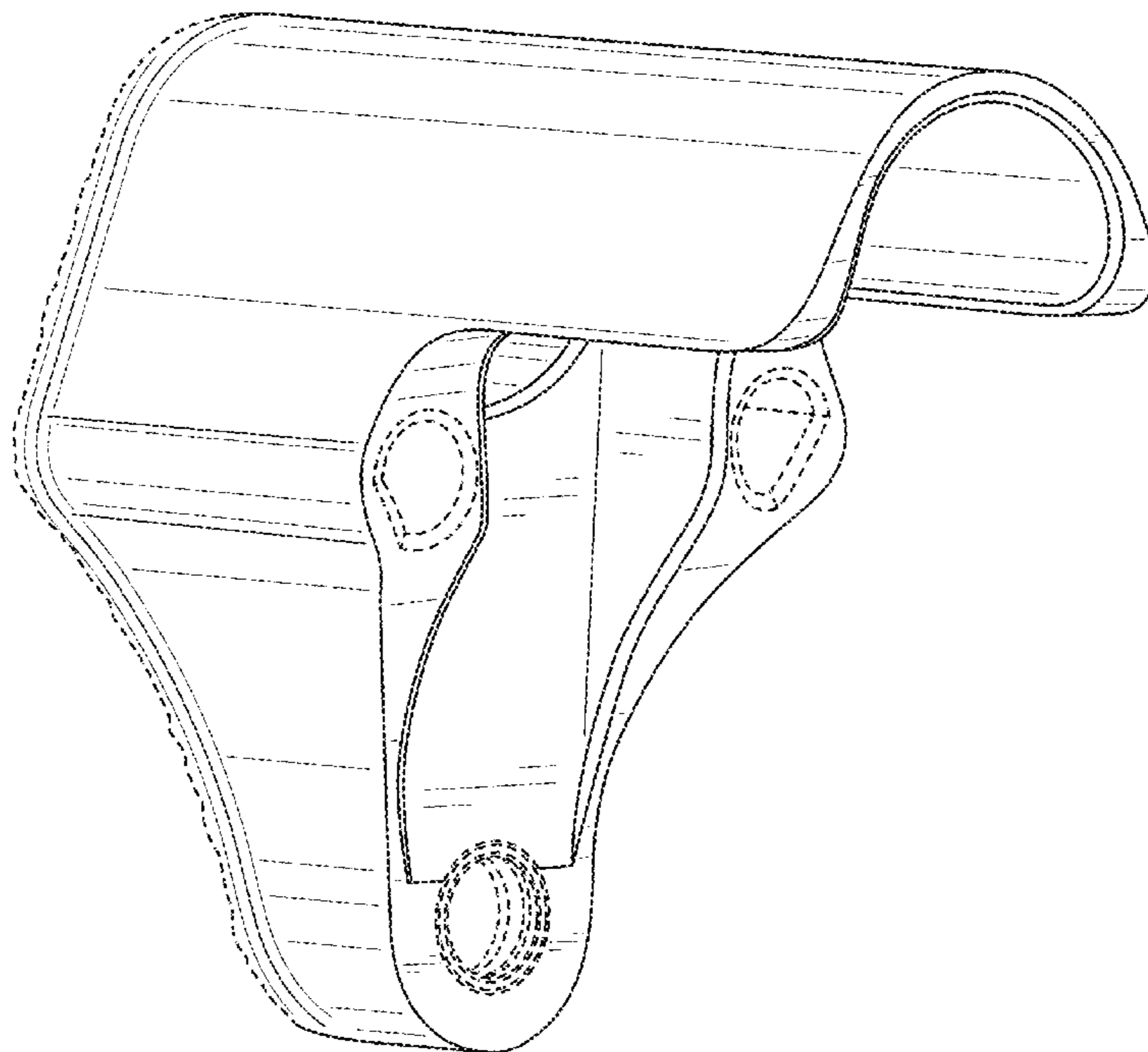

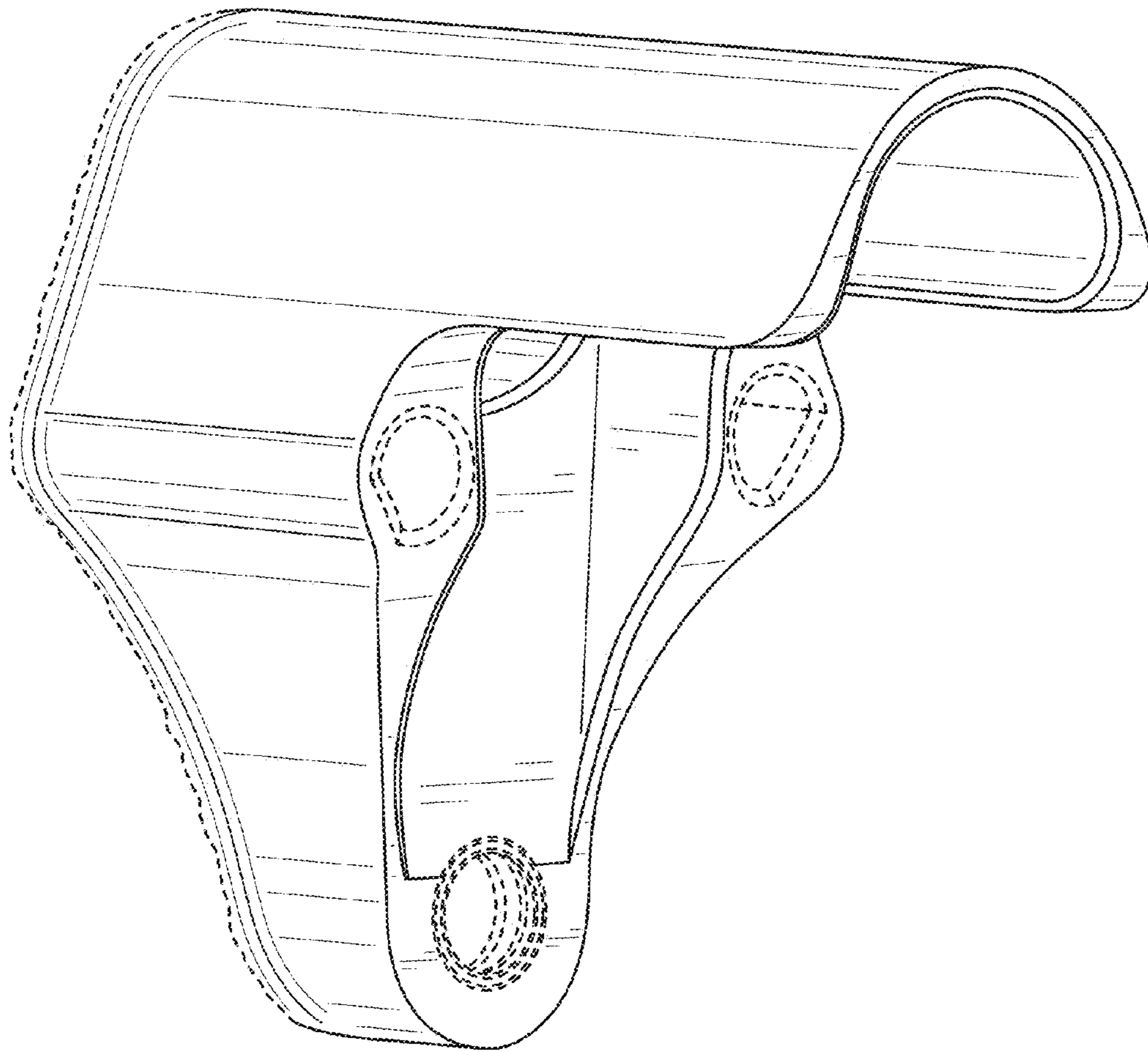

FIG. 1

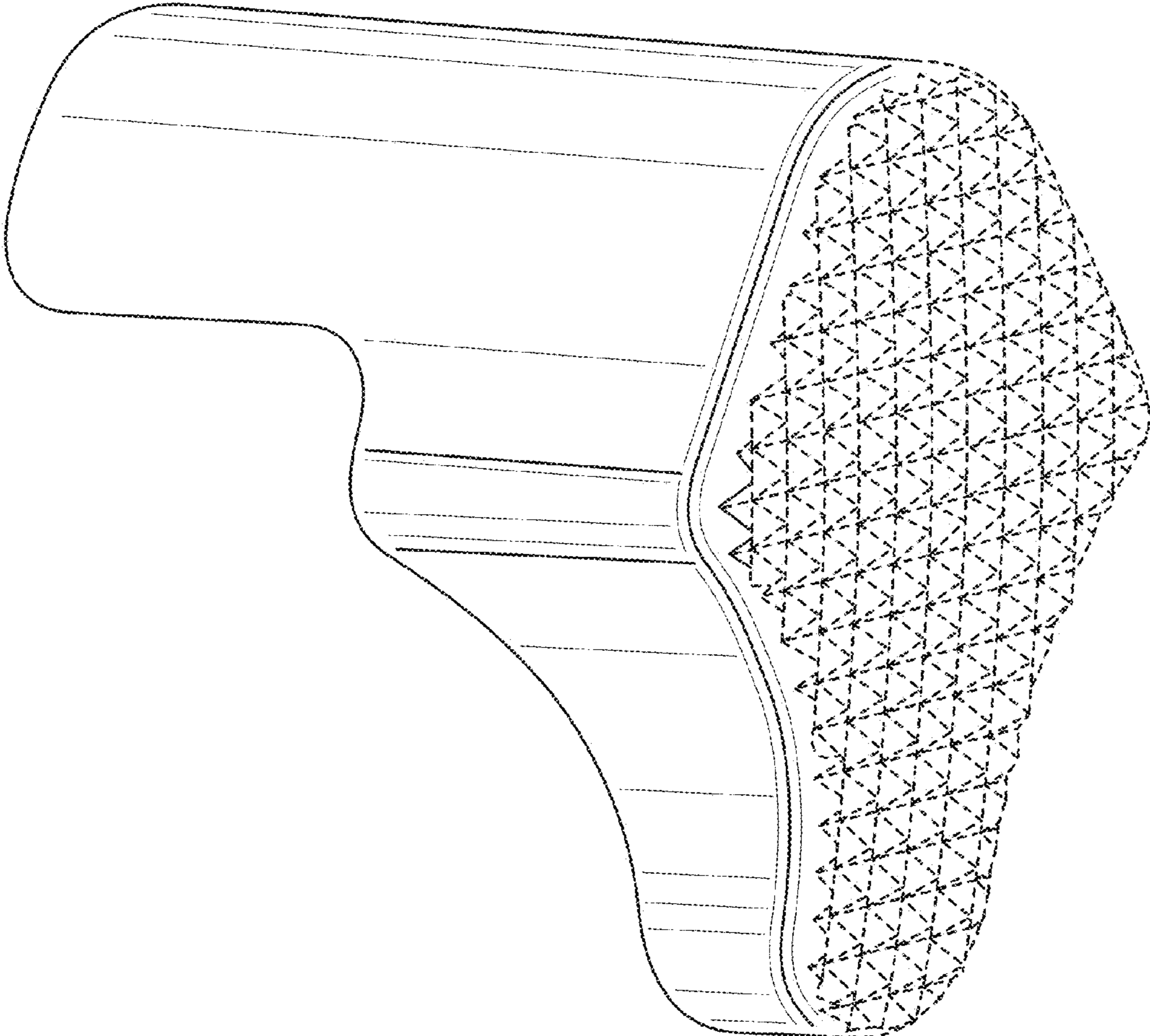

FIG. 2

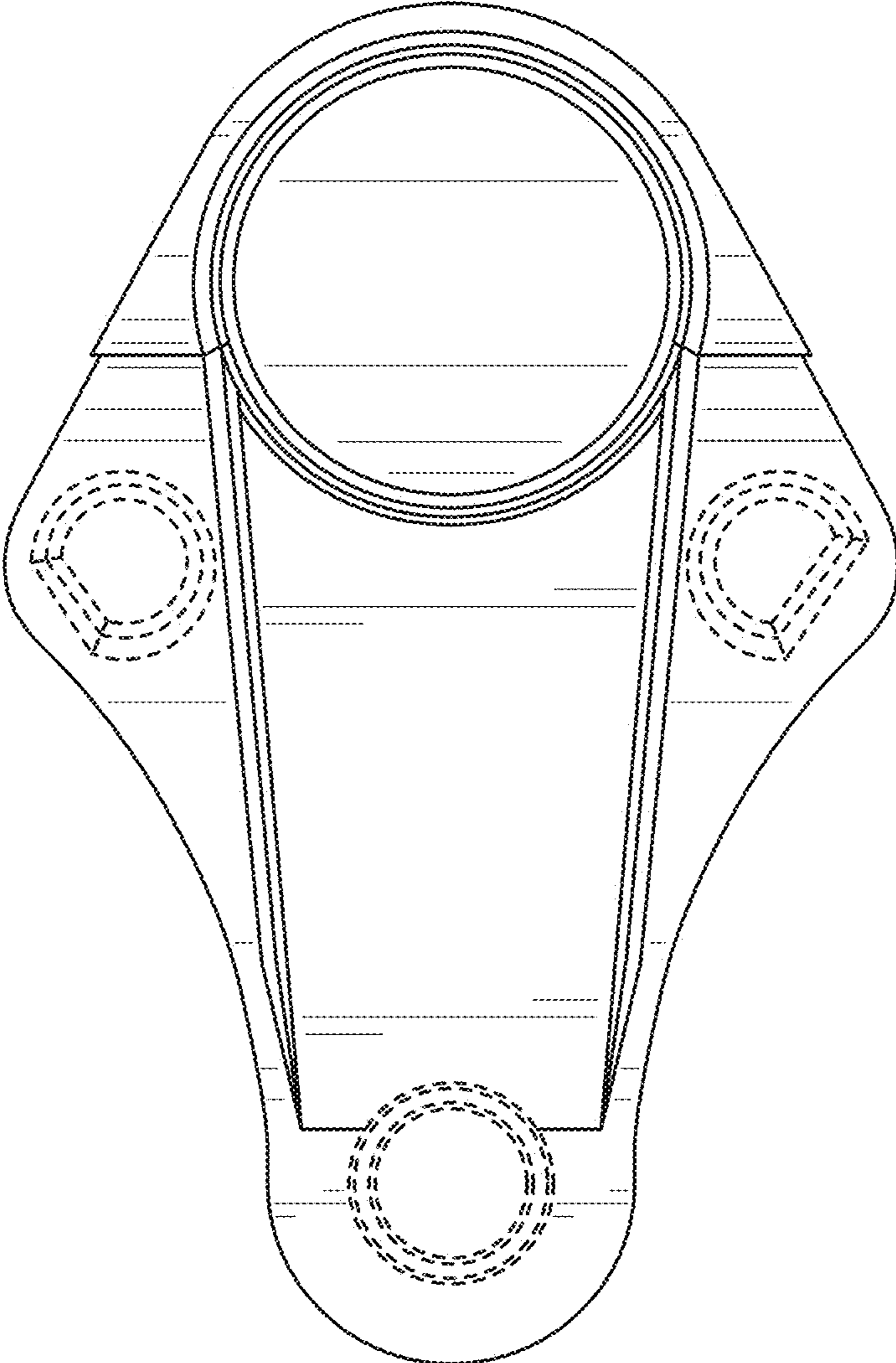

FIG. 3

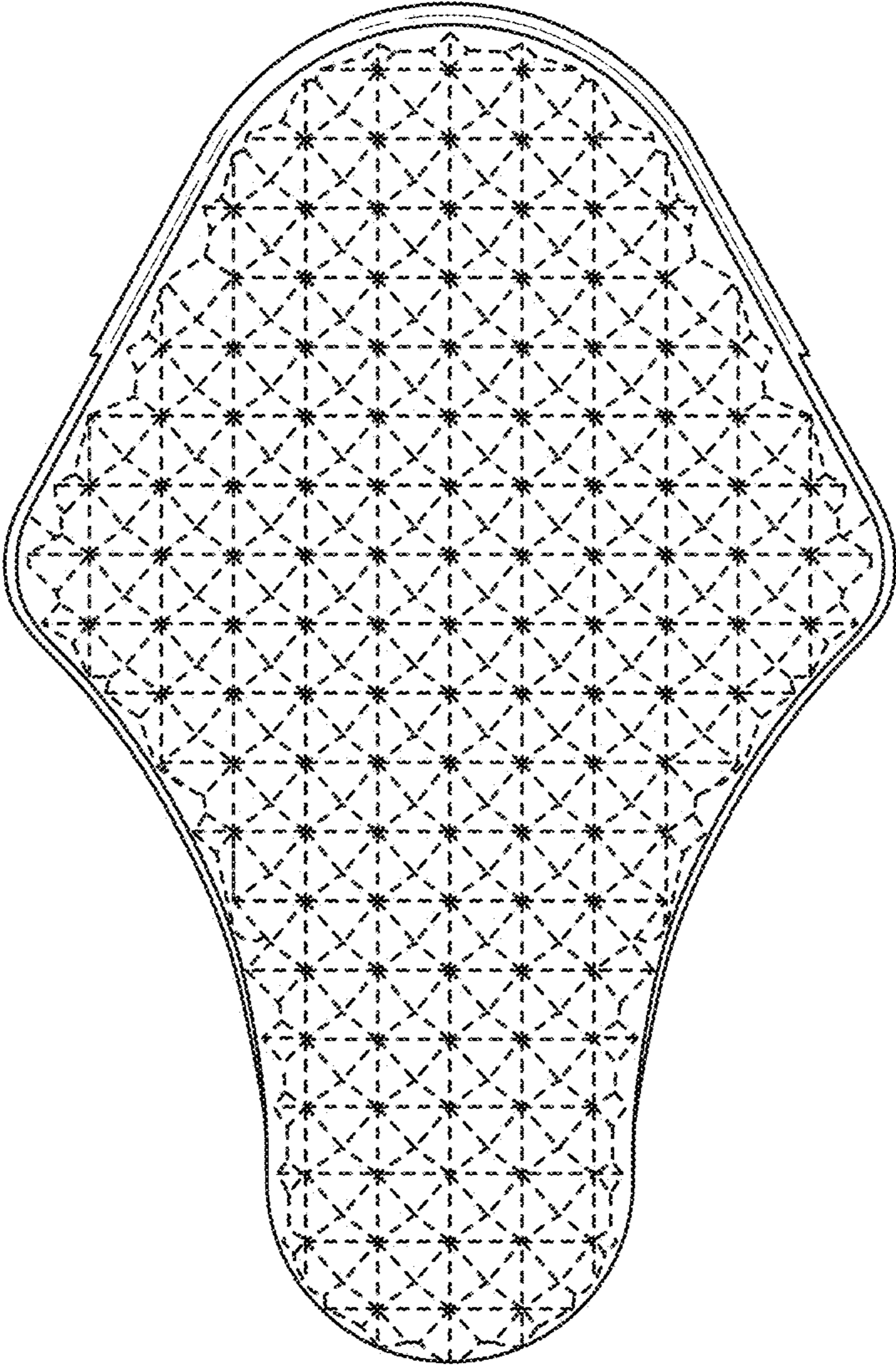

FIG. 4

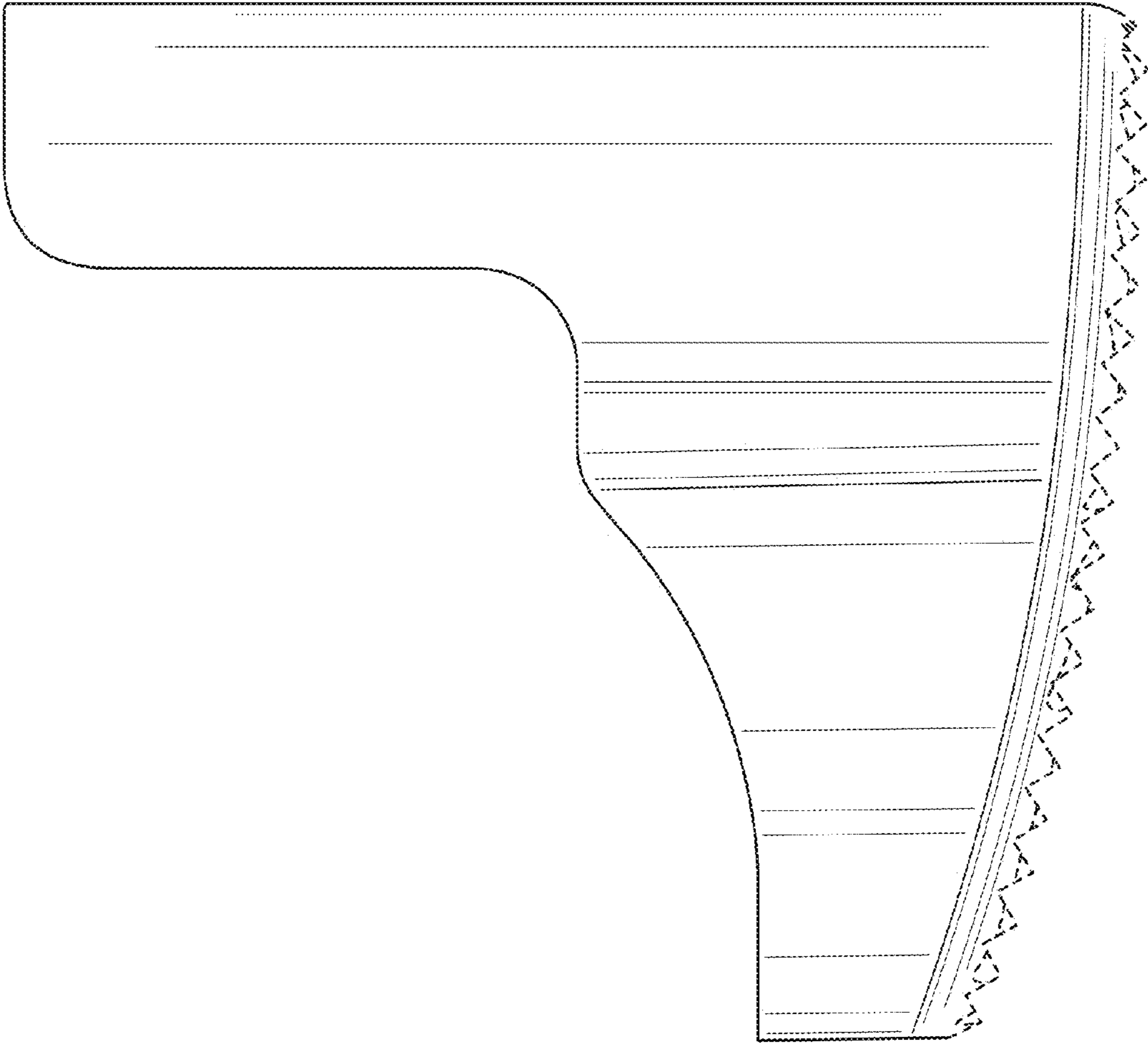

FIG. 5

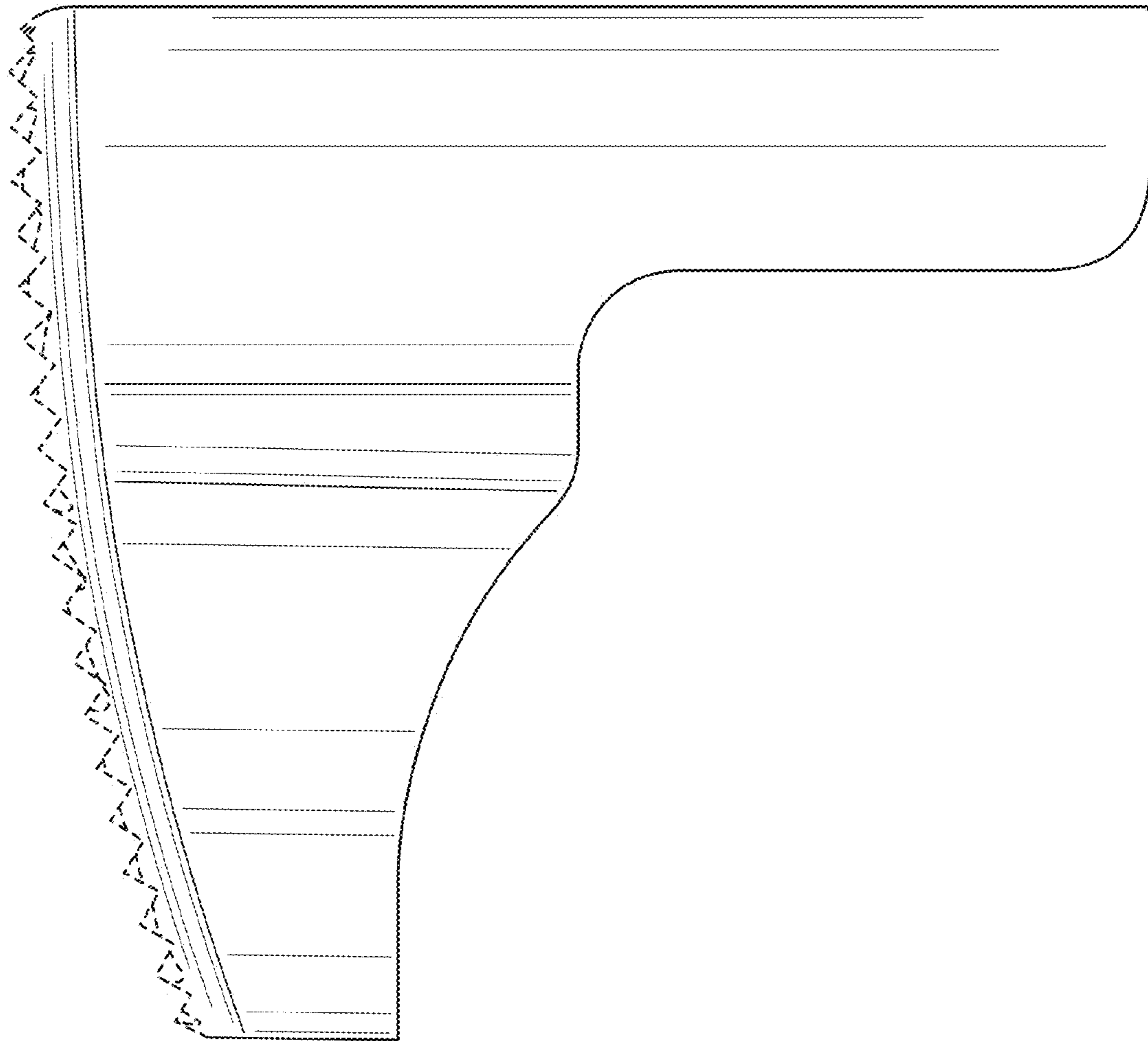

FIG. 6

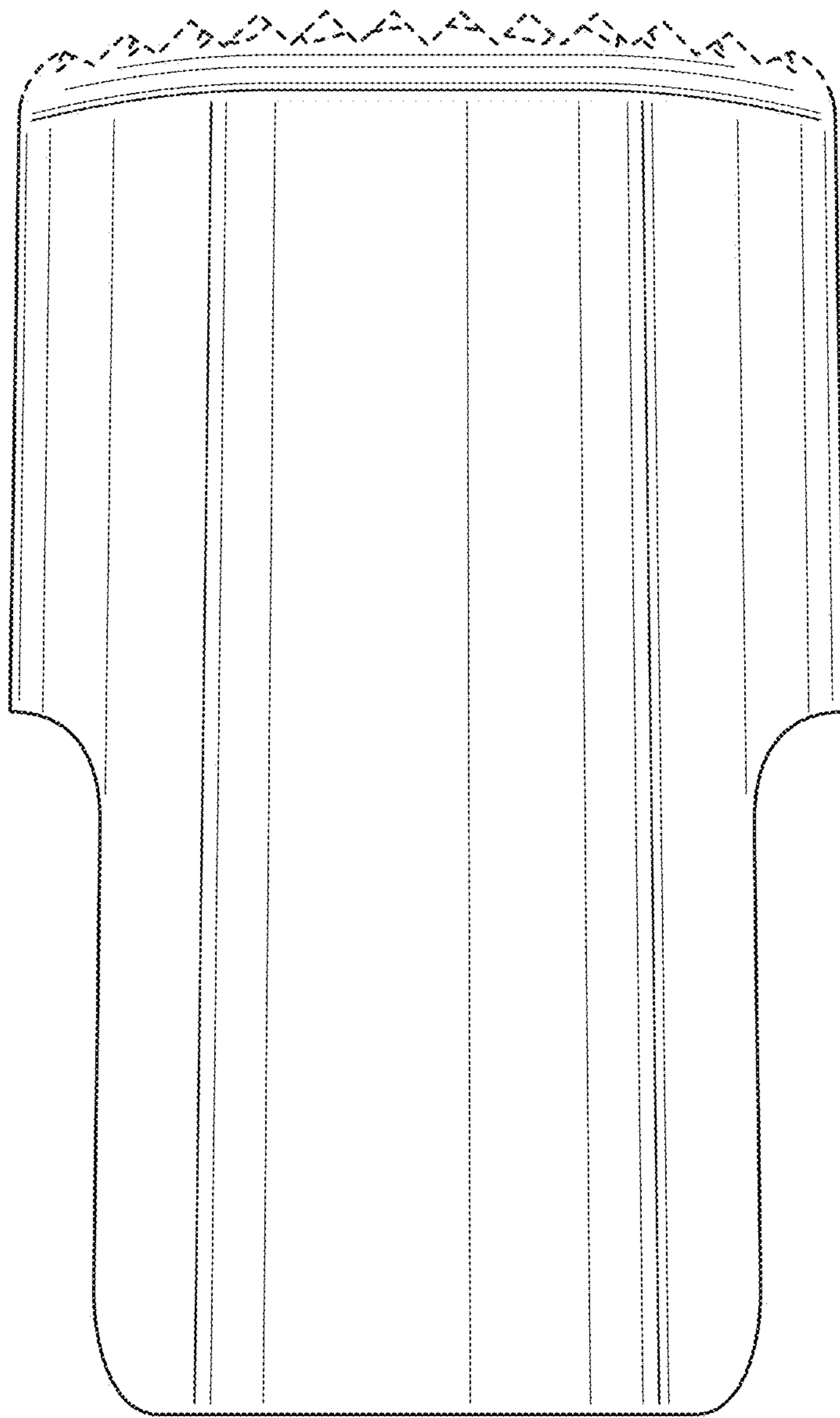

FIG. 7

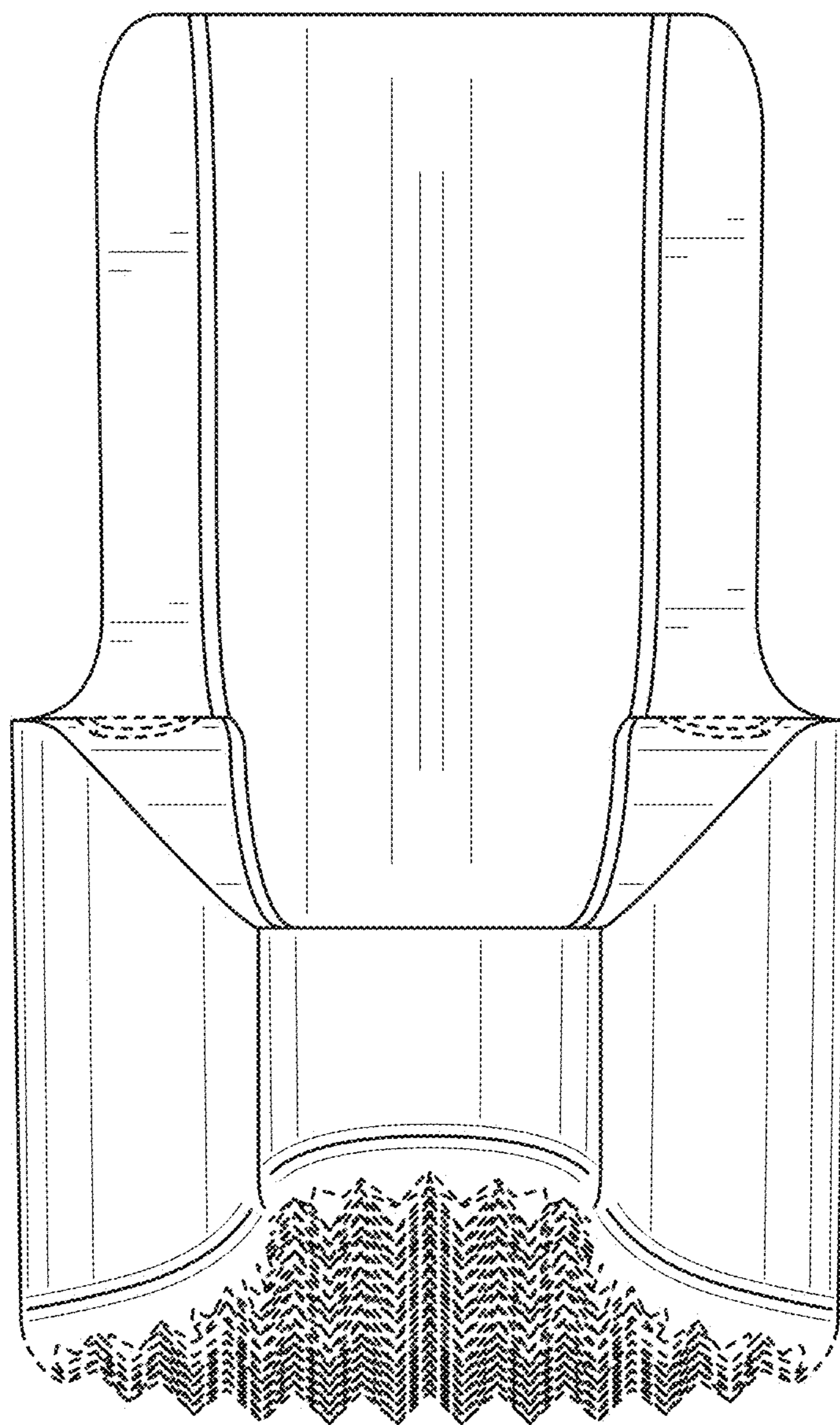

FIG. 8

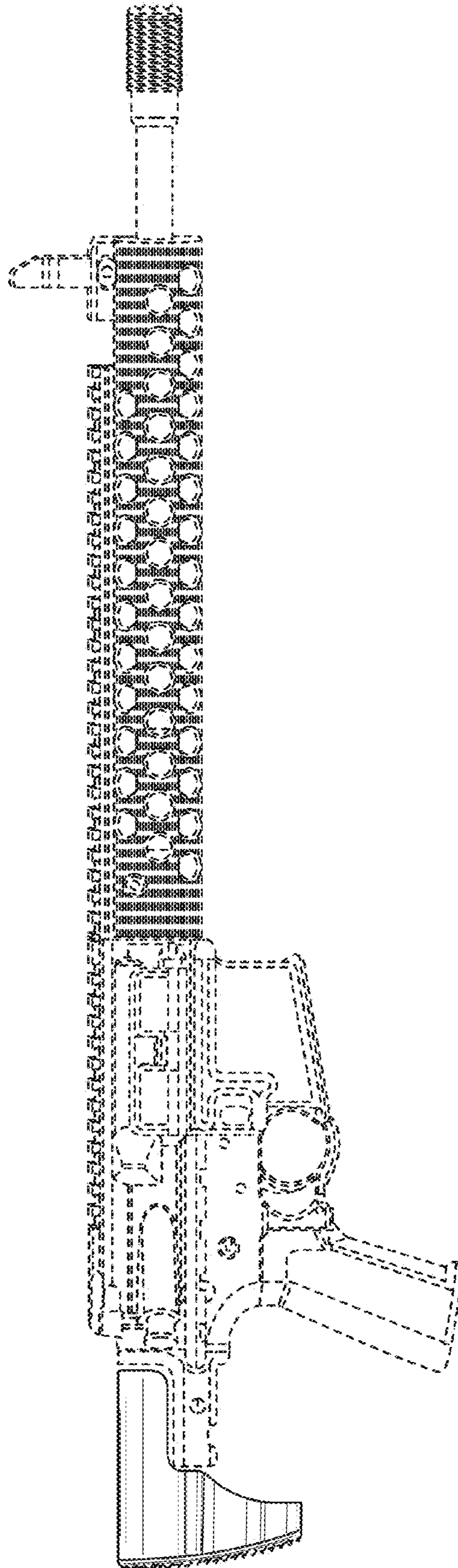

FIG. 9