



US00D753653S

(12) **United States Design Patent**  
**Aumiller et al.**

(10) **Patent No.:** **US D753,653 S**  
(45) **Date of Patent:** **\*\* Apr. 12, 2016**

- (54) **ELECTRONIC DEVICE**
- (71) Applicant: **SAMSUNG ELECTRONICS CO., LTD.**, Suwon-si (KR)
- (72) Inventors: **Curtis Aumiller**, San Jose, CA (US);  
**Pranav Mistry**, Cupertino, CA (US);  
**Chengyuan Wei**, Dalian (CN)
- (73) Assignee: **SAMSUNG ELECTRONICS CO., LTD.**, Suwon-Si (KR)
- (\*\*) Term: **14 Years**
- (21) Appl. No.: **29/453,895**
- (22) Filed: **May 3, 2013**

**Related U.S. Application Data**

- (63) Continuation of application No. 29/449,656, filed on Mar. 15, 2013, now Pat. No. Des. 711,872.
- (51) **LOC (10) Cl.** ..... **14-02**
- (52) **U.S. Cl.**  
USPC ..... **D14/344**
- (58) **Field of Classification Search**  
USPC ..... D14/315-318, 341-347, 420, 426, 129,  
D14/130, 496, 137, 138 R, 138 AA, 138 C,  
D14/138 G, 147, 203.1, 203.3, 204.4, 203.7,  
D14/218, 248, 388, 389; D10/50, 65, 104.1;  
D21/329, 330; D6/308, 310  
CPC ... G06F 3/0485; G06F 3/0488; G06F 1/1613;  
G06F 1/1624; G06F 1/1626; G06F 1/165;  
H04M 1/0202; H04M 1/0264; H04M 1/0214;  
H04M 1/0279; H04M 1/0281; H04M 1/0283;  
H04M 1/72544  
See application file for complete search history.

(56) **References Cited**

**U.S. PATENT DOCUMENTS**

- D47,196 S \* 4/1915 Pagin ..... D26/36
- D181,996 S \* 1/1958 Ornas ..... D12/190
- 3,235,720 A \* 2/1966 Bridge ..... B60Q 1/2653  
362/309

- 3,712,271 A \* 1/1973 Greathouse ..... A61N 5/06  
119/770
- 3,748,458 A \* 7/1973 Morrison ..... B60Q 1/2615  
362/267
- 4,700,981 A \* 10/1987 Seyler ..... B21D 39/20  
156/295
- D298,242 S \* 10/1988 Watanabe ..... D14/138 G
- D300,831 S \* 4/1989 Jenkins ..... D14/218
- 5,155,659 A \* 10/1992 Kunert ..... G06F 3/0238  
220/375

(Continued)

**OTHER PUBLICATIONS**

Oval LED Trailer Utility Light, Flange Mount, 10 Super Diode, announced Jan. 23, 2012 [online], [site visited Nov. 5, 2015]. Available from Internet, URL:<<https://www.etrailer.com/Trailer%ADLights/Optronics/BUL78CB.html>>.\*

(Continued)

*Primary Examiner* — Barbara Fox

*Assistant Examiner* — Dana K Weiland

(74) *Attorney, Agent, or Firm* — Sughrue Mion, PLLC

(57) **CLAIM**

The ornamental design for an electronic device, as shown and described.

**DESCRIPTION**

FIG. 1 is a top front perspective view of a first embodiment of an electronic device showing our new design; FIG. 2 is a front elevational view thereof; FIG. 3 is a rear elevational view thereof; FIG. 4 is a left side elevational view thereof; FIG. 5 is a right side elevational view thereof; FIG. 6 is a top plan view thereof; FIG. 7 is a bottom plan view thereof; and, FIG. 8 is a top rear perspective view thereof with the electronic device shown with a portion of the band partially truncated.

The broken lines shown in the drawings represent portions of the electronic device that form no part of the claimed design.

**1 Claim, 5 Drawing Sheets**

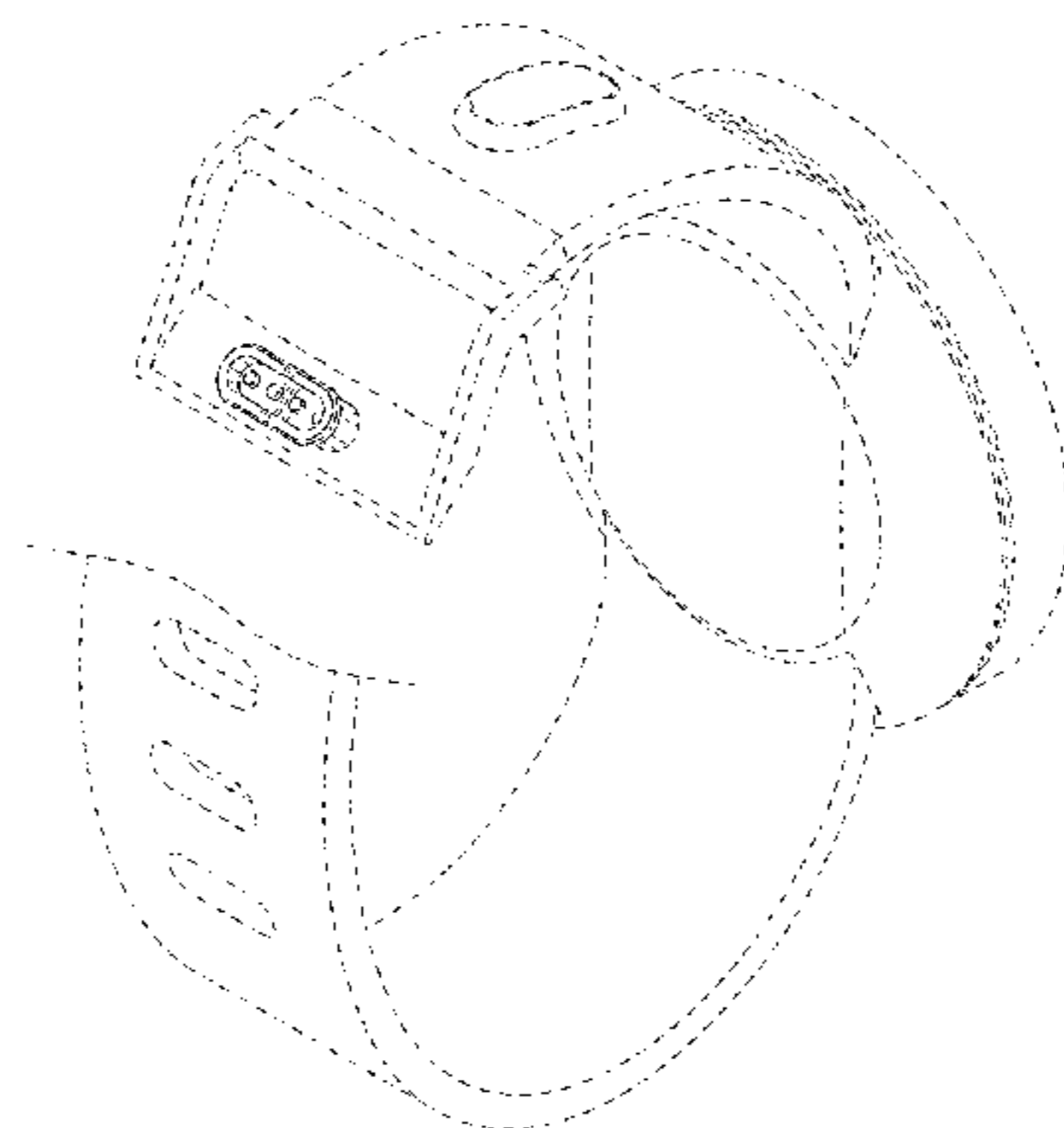

(56)

References Cited

U.S. PATENT DOCUMENTS

5,361,169 A \* 11/1994 Deal ..... B63C 11/02  
359/517  
D416,253 S \* 11/1999 Hibino ..... D14/138 G  
6,538,413 B1 \* 3/2003 Beard ..... G06F 12/1408  
307/116  
D502,173 S \* 2/2005 Jung ..... D13/158  
6,856,792 B2 \* 2/2005 Harmon ..... H04M 1/0227  
379/428.01  
7,042,712 B2 \* 5/2006 Ghosh ..... G06F 1/1605  
206/320  
D527,366 S \* 8/2006 Lee ..... D14/138 AD  
D529,017 S \* 9/2006 Kim ..... D14/138 G  
D554,098 S \* 10/2007 Lee ..... D14/138 AD  
D558,761 S \* 1/2008 Viduya ..... D14/356  
D561,782 S \* 2/2008 Kim ..... D14/496  
D565,569 S \* 4/2008 Viduya ..... D14/356  
D574,019 S \* 7/2008 Amit ..... D15/9  
D579,810 S \* 11/2008 Campman ..... D10/104.1  
D580,395 S \* 11/2008 Oh ..... D14/138 AD  
D583,299 S \* 12/2008 Manson ..... D12/421  
D585,384 S \* 1/2009 Andre ..... D13/146  
7,612,997 B1 \* 11/2009 Diebel ..... G06F 1/1632  
361/679.41  
7,731,191 B2 \* 6/2010 Sternberg ..... A63F 13/06  
273/148 B  
D624,045 S \* 9/2010 Lee ..... D14/138 G  
D634,039 S \* 3/2011 Lee ..... D26/24  
D635,540 S \* 4/2011 Kim ..... D14/138 G  
D635,541 S \* 4/2011 Park ..... D14/138 G  
D646,257 S \* 10/2011 Geum ..... D14/138 G  
D653,573 S \* 2/2012 Kurumagawa ..... D10/104.1  
D653,645 S \* 2/2012 Park ..... D14/138 G  
D654,463 S \* 2/2012 Han ..... D14/138 G  
D654,899 S \* 2/2012 Jung ..... D14/138 G  
D671,108 S \* 11/2012 Rothbaum ..... D14/250  
D682,333 S \* 5/2013 Kim ..... D16/202  
D684,571 S \* 6/2013 Akana ..... D14/341  
D697,646 S \* 1/2014 He ..... D26/24  
D711,872 S \* 8/2014 Aumiller ..... D14/344  
D717,801 S \* 11/2014 Rantala ..... D14/439  
D718,712 S \* 12/2014 Aumiller ..... D13/108

D721,063 S \* 1/2015 Chung ..... D14/248  
D721,355 S \* 1/2015 Chung ..... D14/248  
D724,078 S \* 3/2015 Andre ..... D14/341  
D730,361 S \* 5/2015 Akana ..... D14/439  
D733,146 S \* 6/2015 Akana ..... D14/439  
9,161,467 B2 \* 10/2015 Murakata ..... H05K 5/0086  
2005/0064917 A1 \* 3/2005 Peng ..... H04M 1/021  
455/575.1  
2006/0281501 A1 \* 12/2006 Zuo ..... H04M 1/0262  
455/575.1  
2007/0073236 A1 \* 3/2007 Mernoe ..... A61M 5/14244  
604/151  
2007/0099700 A1 \* 5/2007 Solomon ..... G07F 17/3211  
463/34  
2008/0074329 A1 \* 3/2008 Caballero ..... H01Q 1/088  
343/702  
2008/0291641 A1 \* 11/2008 Sheng ..... G06F 1/1658  
361/726  
2009/0067989 A1 \* 3/2009 Estes ..... A61M 5/14244  
415/118  
2009/0219676 A1 \* 9/2009 Murakata ..... H05K 5/0086  
361/679.01  
2014/0139637 A1 \* 5/2014 Mistry ..... H04N 5/2252  
348/46

OTHER PUBLICATIONS

Tizen News, announced Nov. 2, 2015 [online], [site visited Nov. 5, 2015]. Available from Internet, URL: <<http://blog.tizenappdev.com/>>.\*  
Bluhm Enterprises LED Trailer Lughts Rubber Gasket, announced 2015 [online], [site visited Nov. 5, 2015]. Available from Internet, URL: <[http://www.amazon.com/Enterprises-Trailer-Lights-Rubber-Gasket/dp/B003CKNUA2/ref=sr\\_1\\_2?ie=UTF8&qid=1447177013&sr=8-2&keywords=bluhm+enterprises+LED+trailer+Lights](http://www.amazon.com/Enterprises-Trailer-Lights-Rubber-Gasket/dp/B003CKNUA2/ref=sr_1_2?ie=UTF8&qid=1447177013&sr=8-2&keywords=bluhm+enterprises+LED+trailer+Lights)>.\*  
6 In. Submersilbe Oval LED Stop/Turn Trailer Tail Light, announced Dec. 6, 2011 [online], [site visited Nov. 5, 2015]. Available from Internet, URL: <[http://www.amazon.com/Enterprises-Trailer-Lights-Rubber-Gasket/dp/B003CKNUA2/ref=sr\\_1\\_2?ie=UTF8&qid=1447177013&sr=8-2&keywords=bluhm+enterprises+LED+trailer+Lights](http://www.amazon.com/Enterprises-Trailer-Lights-Rubber-Gasket/dp/B003CKNUA2/ref=sr_1_2?ie=UTF8&qid=1447177013&sr=8-2&keywords=bluhm+enterprises+LED+trailer+Lights)>.\*

\* cited by examiner

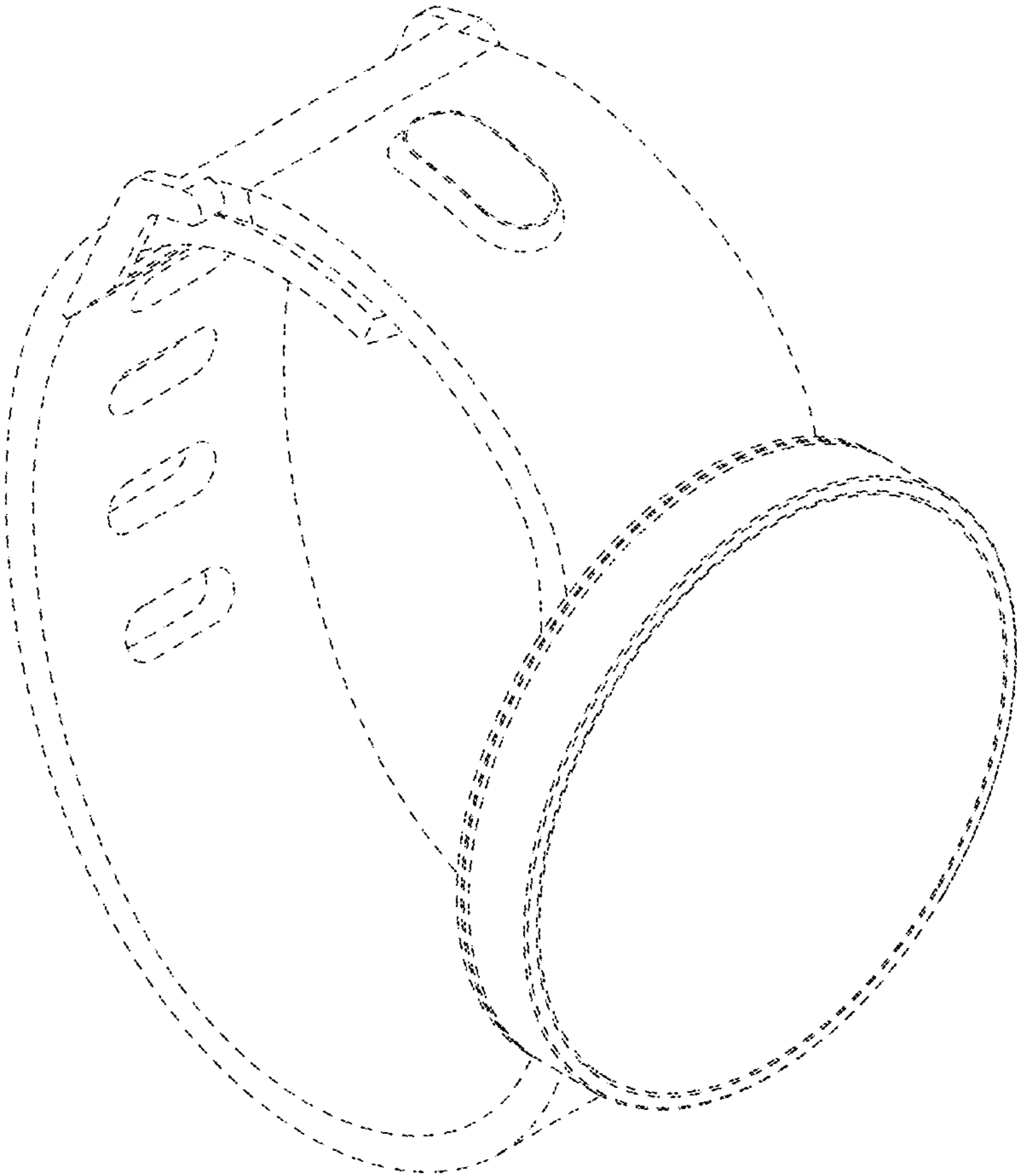

FIG. 1

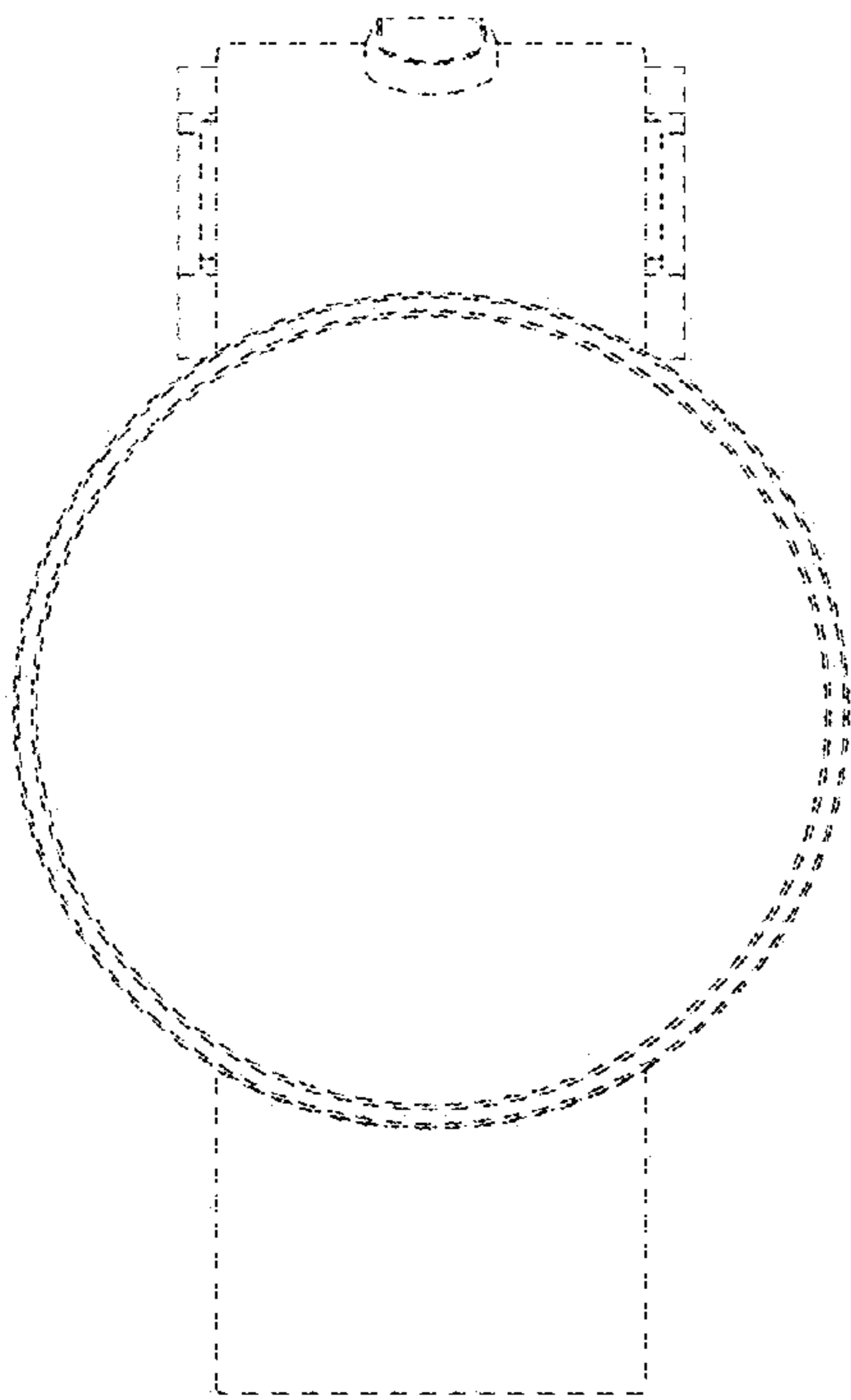

FIG. 2

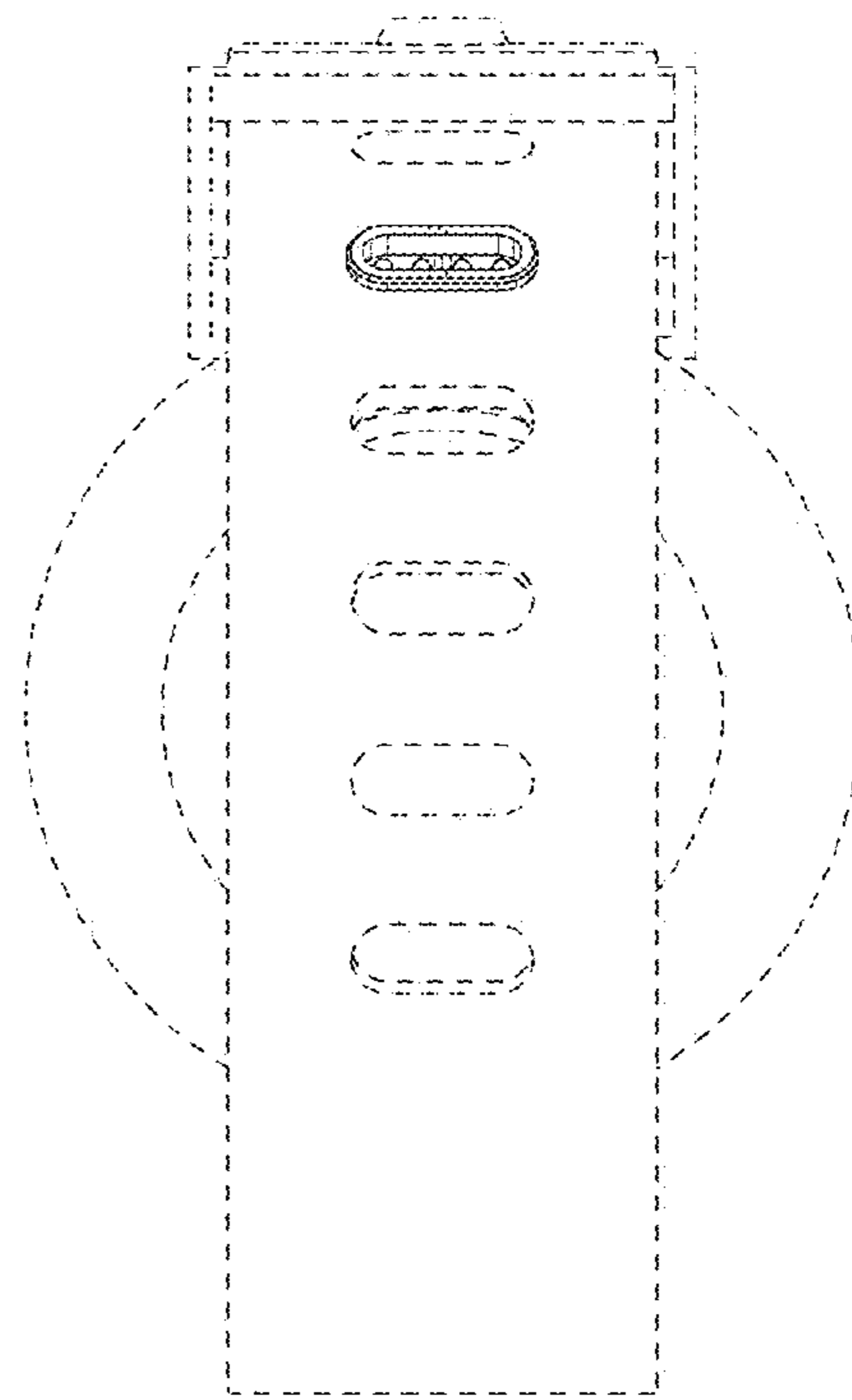

FIG. 3

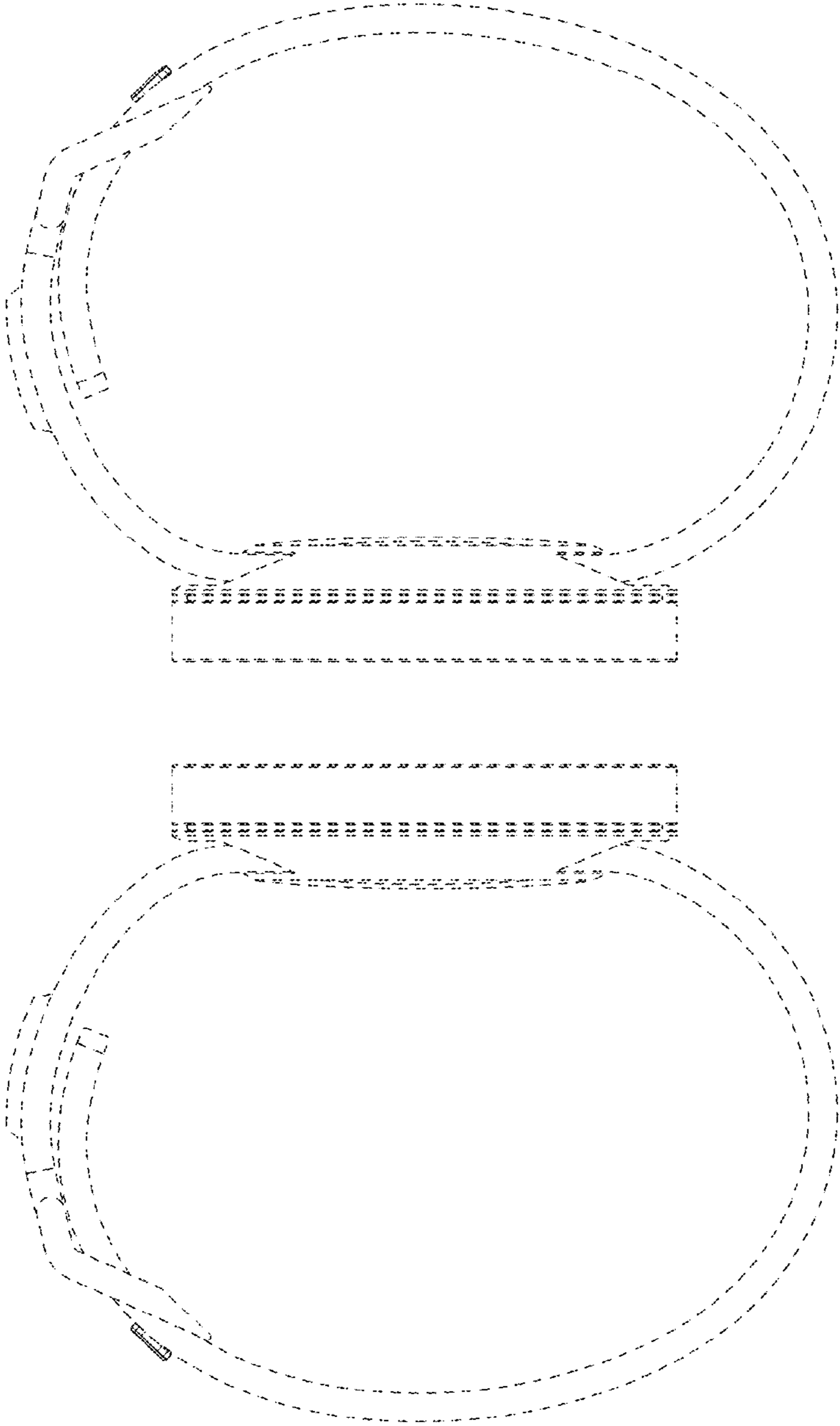

FIG. 5

FIG. 4

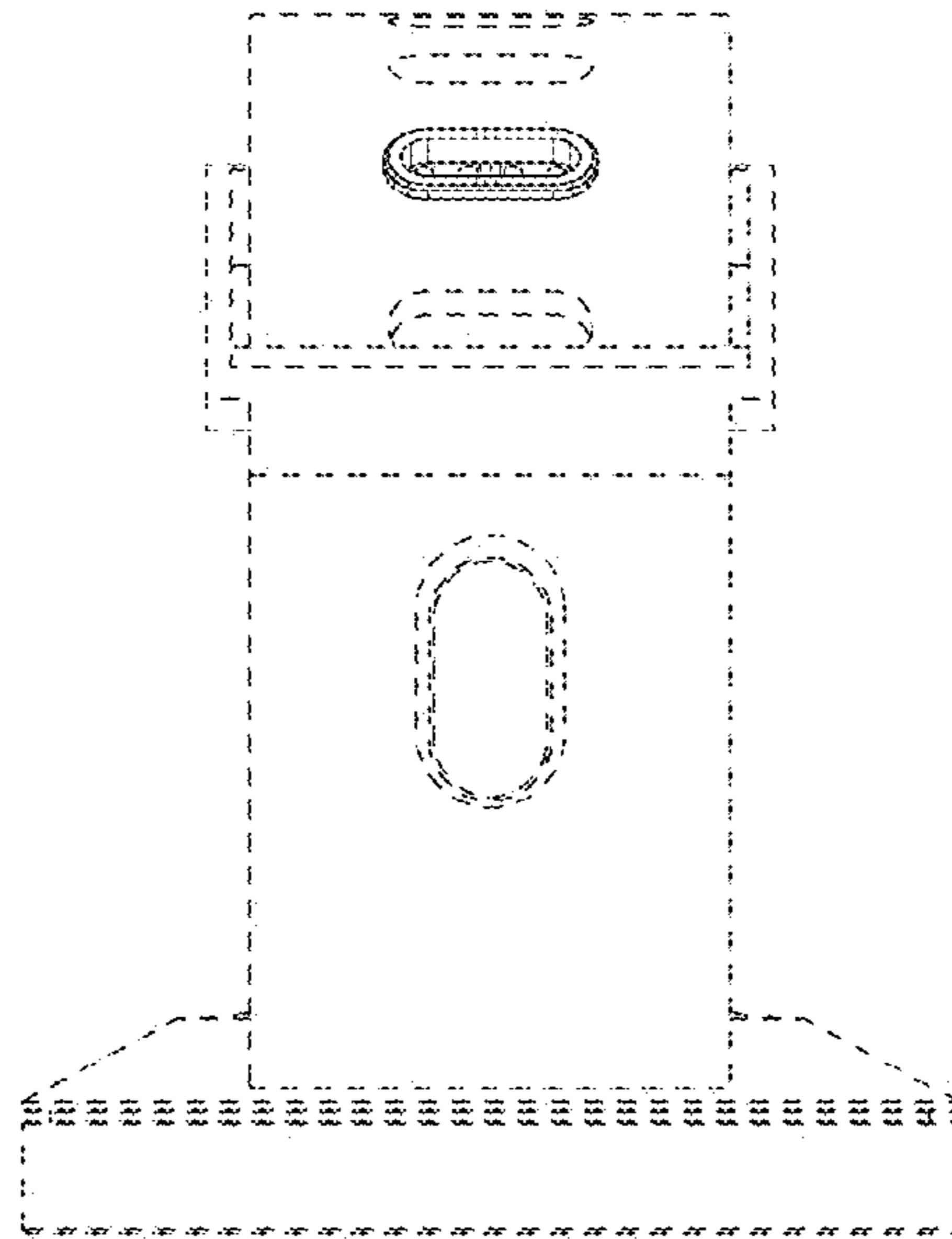

FIG. 6

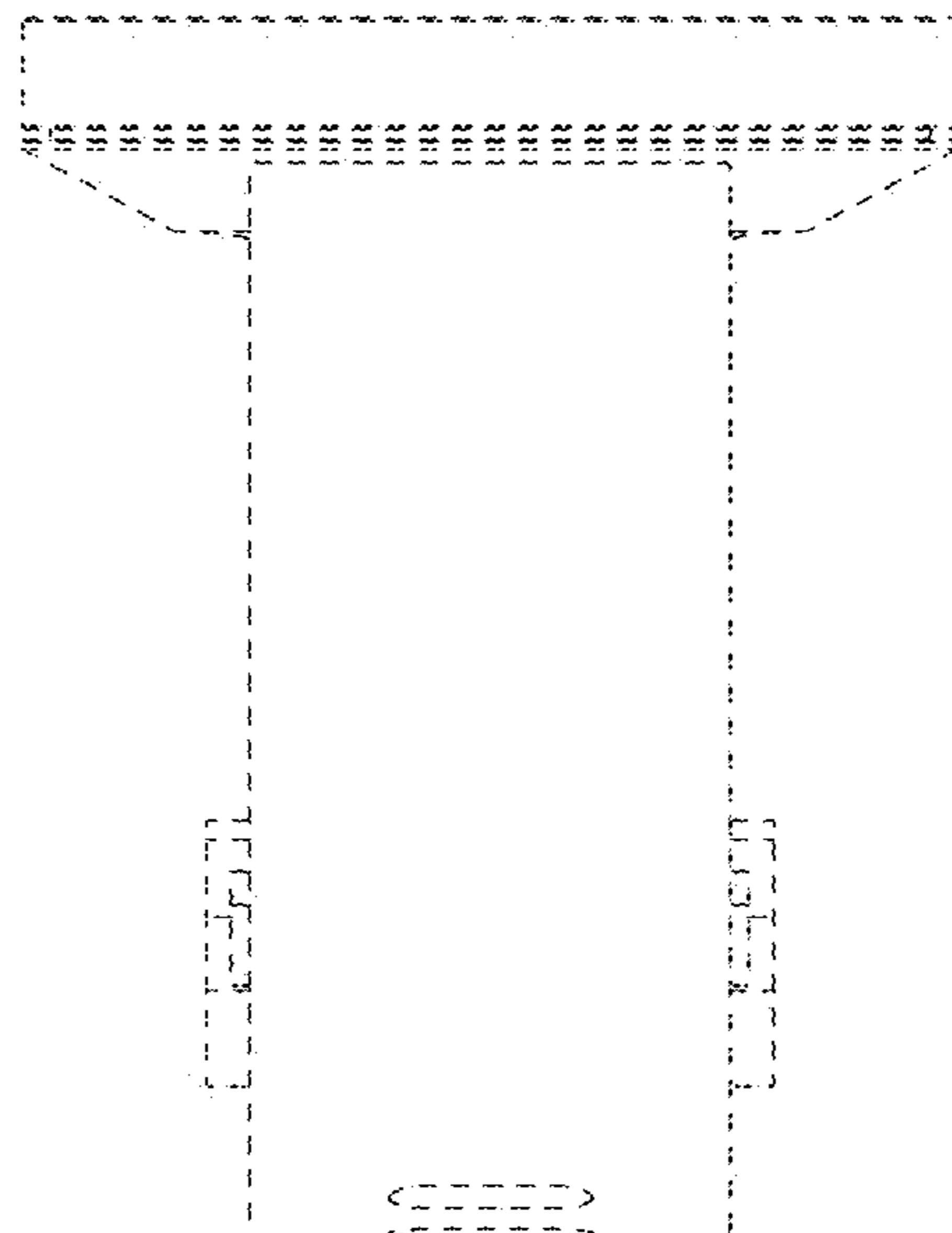

FIG. 7

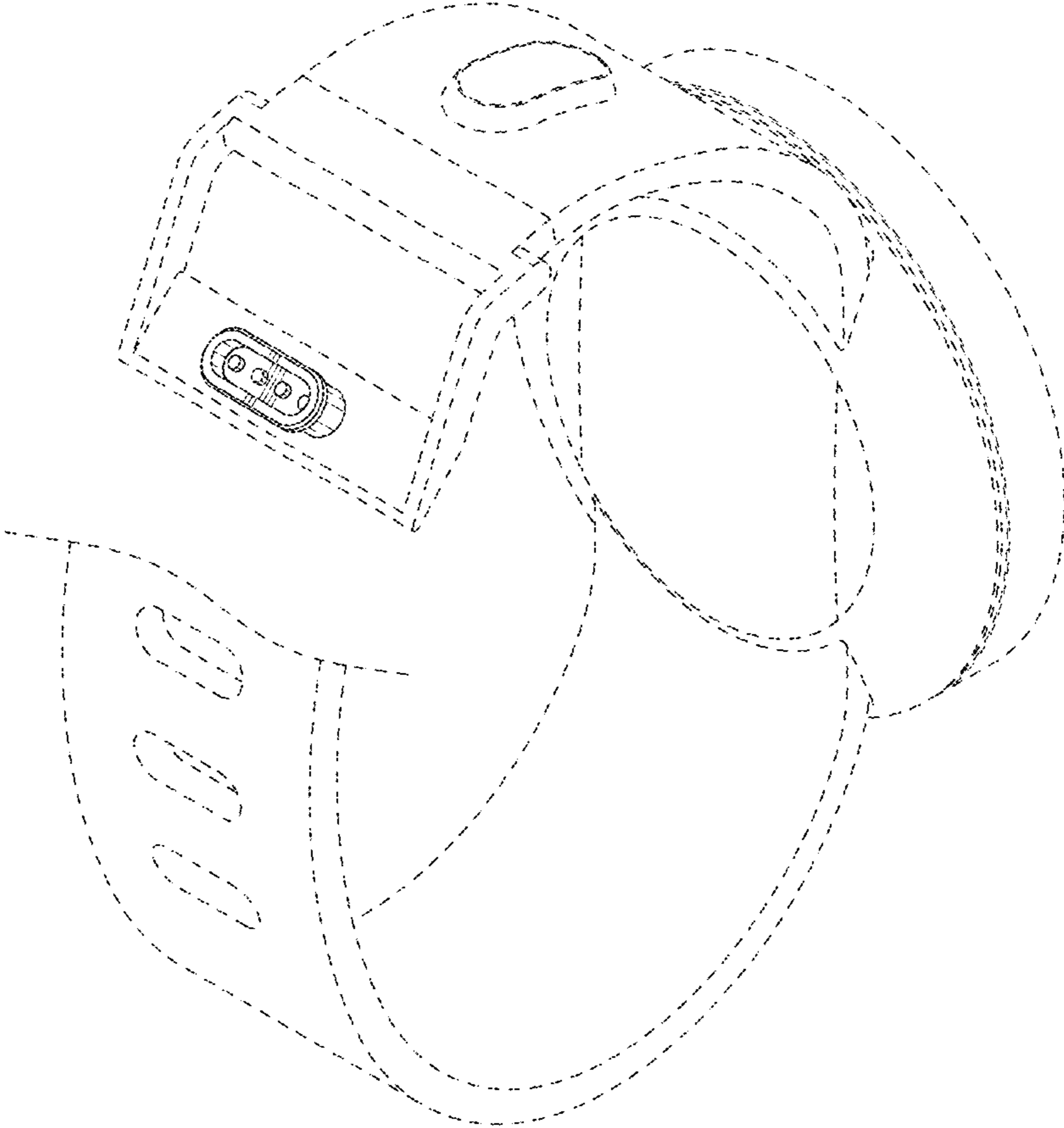

FIG. 8