



US00D753578S

(12) **United States Design Patent**  
**Barnes**

(10) **Patent No.:** **US D753,578 S**  
(45) **Date of Patent:** **\*\* Apr. 12, 2016**

(54) **VEHICLE COMPONENT**

(71) Applicant: **Jaguar Land Rover Limited**, Coventry (GB)

(72) Inventor: **Ian Barnes**, Coventry (GB)

(73) Assignee: **Jaguar Land Rover Limited** (GB)

(\*\*) Term: **14 Years**

(21) Appl. No.: **29/489,186**

(22) Filed: **Apr. 28, 2014**

(30) **Foreign Application Priority Data**

Oct. 28, 2013 (EM) ..... 002334201

(51) **LOC (10) Cl.** ..... **12-16**

(52) **U.S. Cl.**  
USPC ..... **D12/426.1**

(58) **Field of Classification Search**  
USPC ..... D12/426.1, 426, 400, 406, 415-420,  
D12/424

CPC ..... A47B 31/06

See application file for complete search history.

(56) **References Cited**

**U.S. PATENT DOCUMENTS**

3,952,988	A *	4/1976	Easterly	.....	B60N 3/005 108/44
D335,226	S *	5/1993	Horne	.....	D12/426.1
D338,358	S *	8/1993	Schroeder	.....	D12/426.1
D356,902	S *	4/1995	Crowell	.....	D12/426.1
D514,057	S *	1/2006	Borunda	.....	D12/426.1
D737,750	S *	9/2015	Garrett	.....	D12/426.1
2015/0282608	A1 *	10/2015	Sakanoue	.....	B60N 3/002 108/42
2015/0291073	A1 *	10/2015	Pajic	.....	A47B 23/00 320/108
2015/0296977	A1 *	10/2015	Calderone	.....	A47B 23/025 5/2.1
2015/0305491	A1 *	10/2015	Orsini	.....	A47B 5/04 108/116

\* cited by examiner

*Primary Examiner* — Katrina A Betton

(74) *Attorney, Agent, or Firm* — Fishman Stewart PLLC

(57) **CLAIM**

The ornamental design for a vehicle component, as shown and described.

**DESCRIPTION**

FIG. 1 is a rear perspective view of the vehicle component in the extended and open position.

FIG. 2 is a rear view of the vehicle component in the extended and open position.

FIG. 3 is a front view of the vehicle component in the extended and open position.

FIG. 4 is a left side view of the vehicle component in the extended and open position.

FIG. 5 is a right side view of the vehicle component in the extended and open position.

FIG. 6 is a top view of the vehicle component in the extended and open position.

FIG. 7 is a bottom view of the vehicle component in the extended and open position.

FIG. 8 is a rear perspective view of the vehicle component in the extended and open position, with holder portions rotated.

FIG. 9 is a rear view of the vehicle component in the extended and open position, with holder portions rotated.

FIG. 10 is a front view of the vehicle component in the extended and open position, with holder portions rotated.

FIG. 11 is a left side view of the vehicle component in the extended and open position, with holder portions rotated.

FIG. 12 is a right side view of the vehicle component in the extended and open position, with holder portions rotated.

FIG. 13 is a top view of the vehicle component in the extended and open position, with holder portions rotated.

FIG. 14 is a bottom view of the vehicle component in the extended and open position, with holder portions rotated.

FIG. 15 is a rear perspective view of the vehicle component in the extended and closed position.

FIG. 16 is a rear view of the vehicle component in the extended and closed position.

FIG. 17 is a front view of the vehicle component in the extended and closed position.

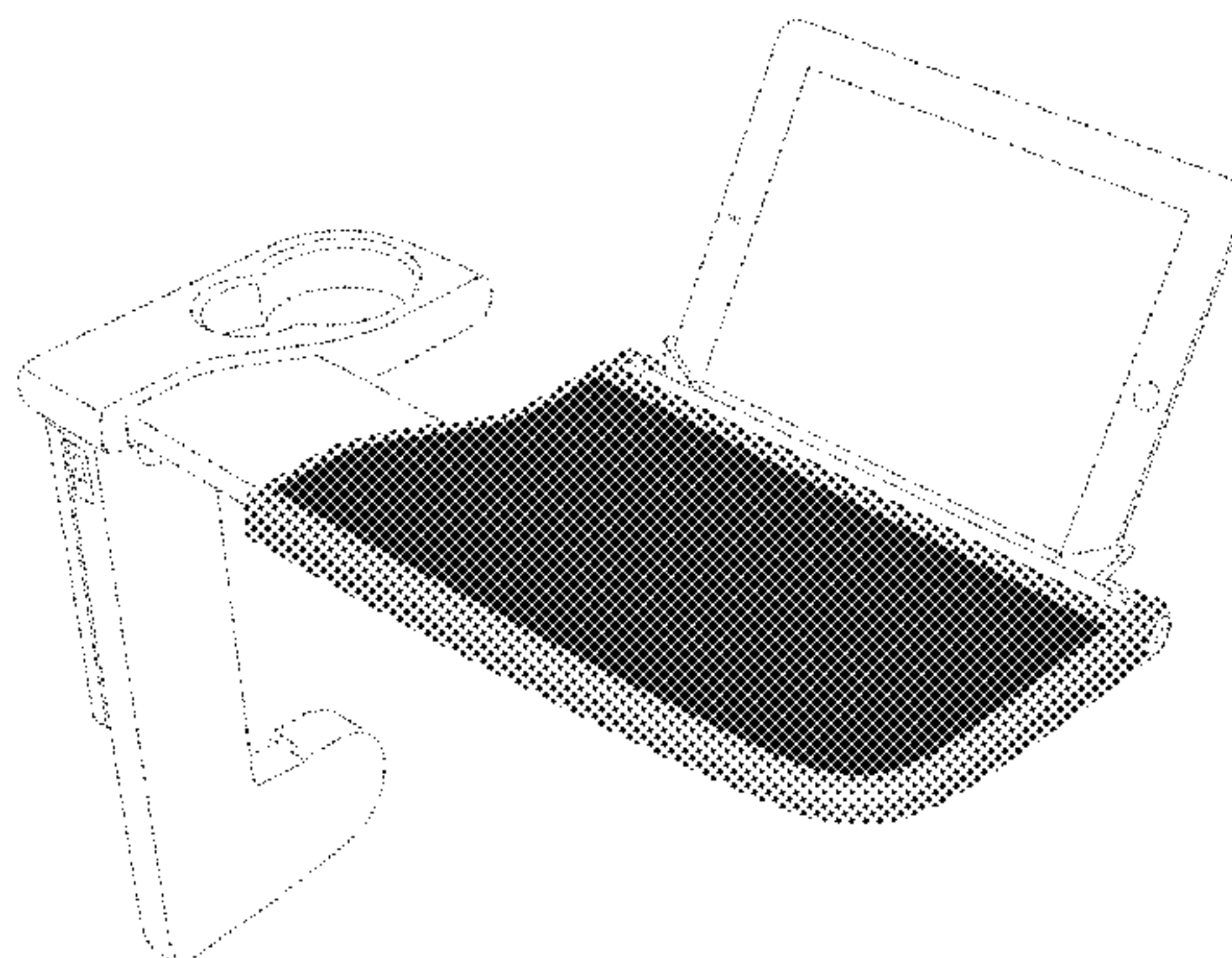

FIG. **18** is a left side view of the vehicle component in the extended and closed position.

FIG. **19** is a right side view of the vehicle component in the extended and closed position.

FIG. **20** is a top view of the vehicle component in the extended and closed position.

FIG. **21** is a bottom view of the vehicle component in the extended and closed position.

FIG. **22** is a rear perspective view of the vehicle component in the non-extended and closed position.

FIG. **23** is a rear view of the vehicle component in the non-extended and closed position.

FIG. **24** is a front view of the vehicle component in the non-extended and closed position.

FIG. **25** is a left side view of the vehicle component in the non-extended and closed position.

FIG. **26** is a right side view of the vehicle component in the non-extended and closed position.

FIG. **27** is a top view of the vehicle component in the non-extended and closed position.

FIG. **28** is a bottom view of the vehicle component in the non-extended and closed position.

FIG. **29** is a supplemental front perspective view of the vehicle component in the extended and open position with holder portions rotated and with notebook computer in place; and,

FIG. **30** is a supplemental rear perspective view of the vehicle component in the extended and open position with holder portions rotated and with notebook computer in place.

The whited out portions and portions shown in dashed lines of FIGS. **1-30** form no part of the claimed design.

**1 Claim, 13 Drawing Sheets**

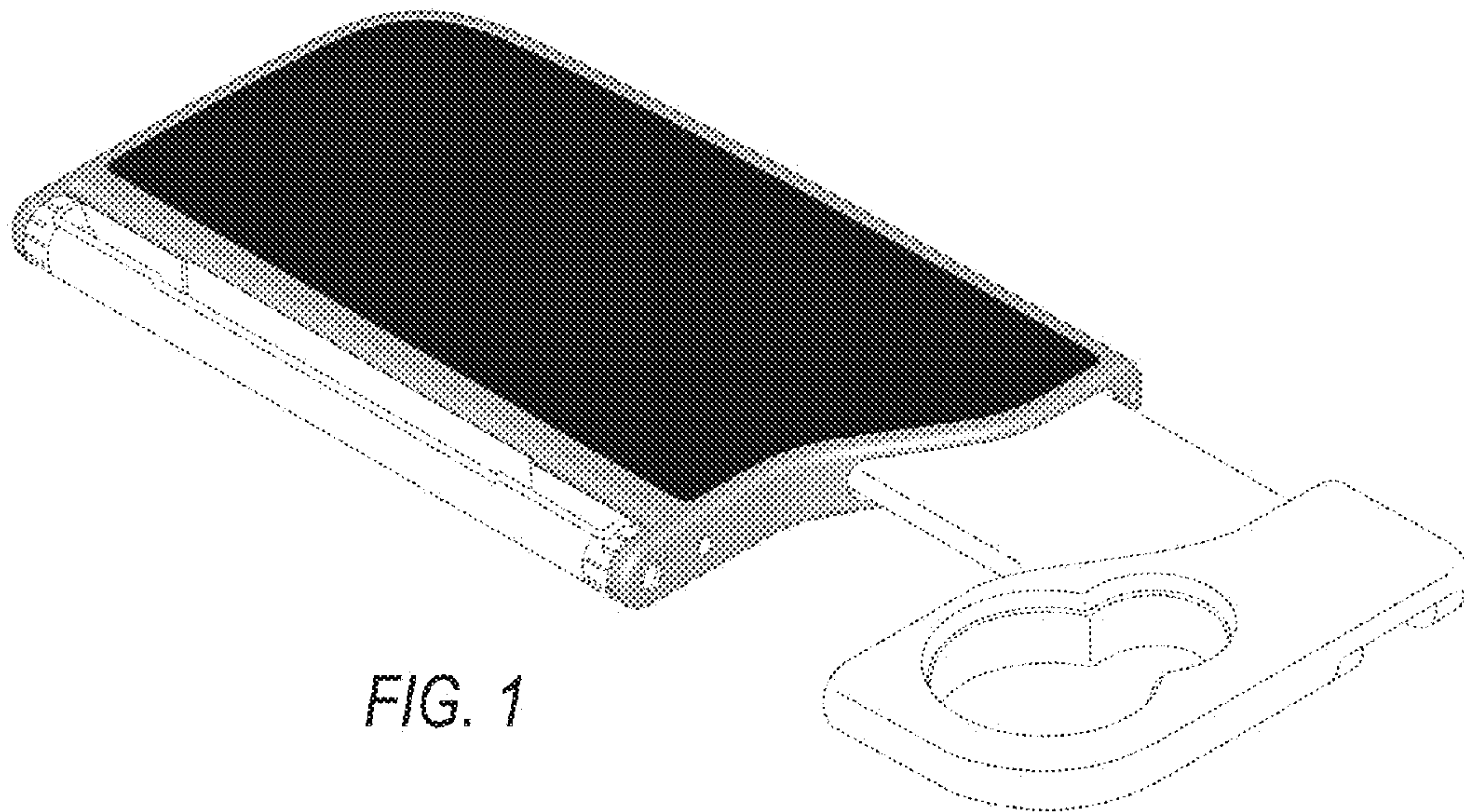

FIG. 1

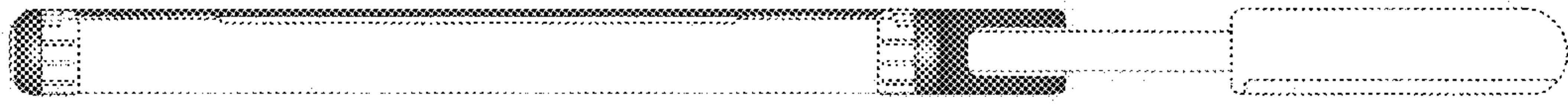

FIG. 2

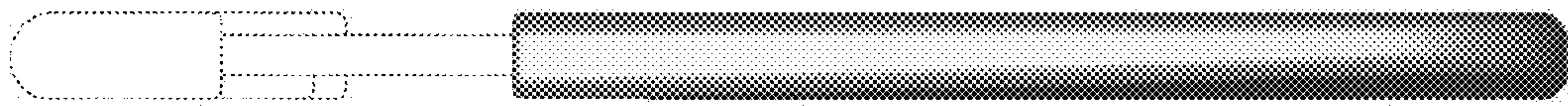

FIG. 3

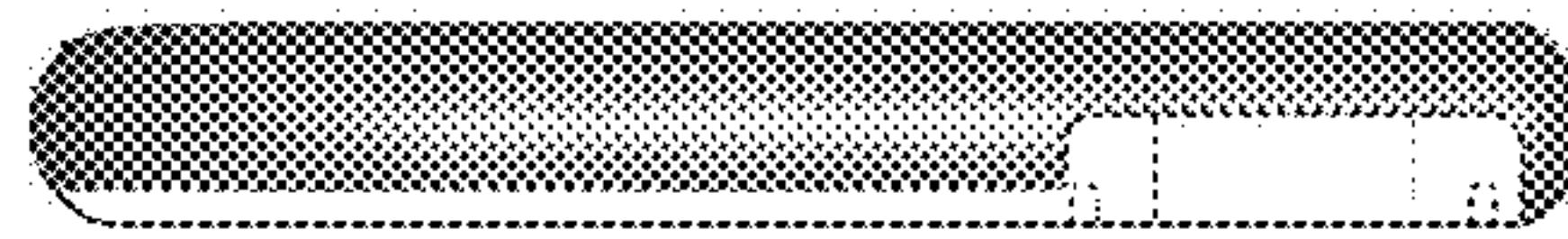

FIG. 4

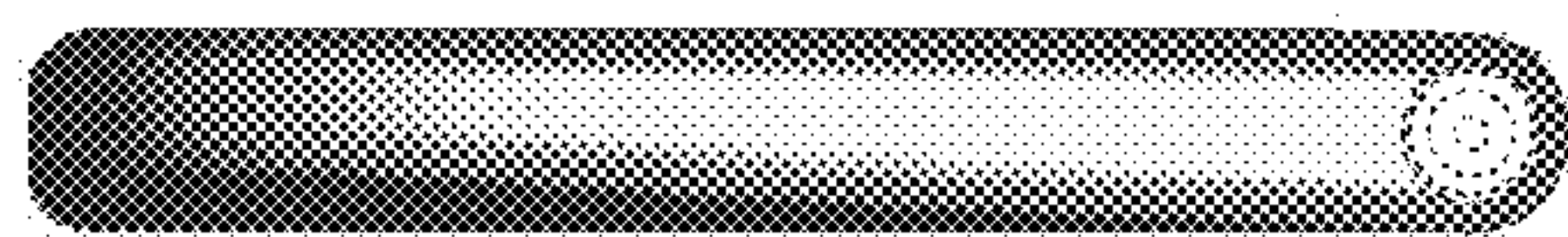

FIG. 5



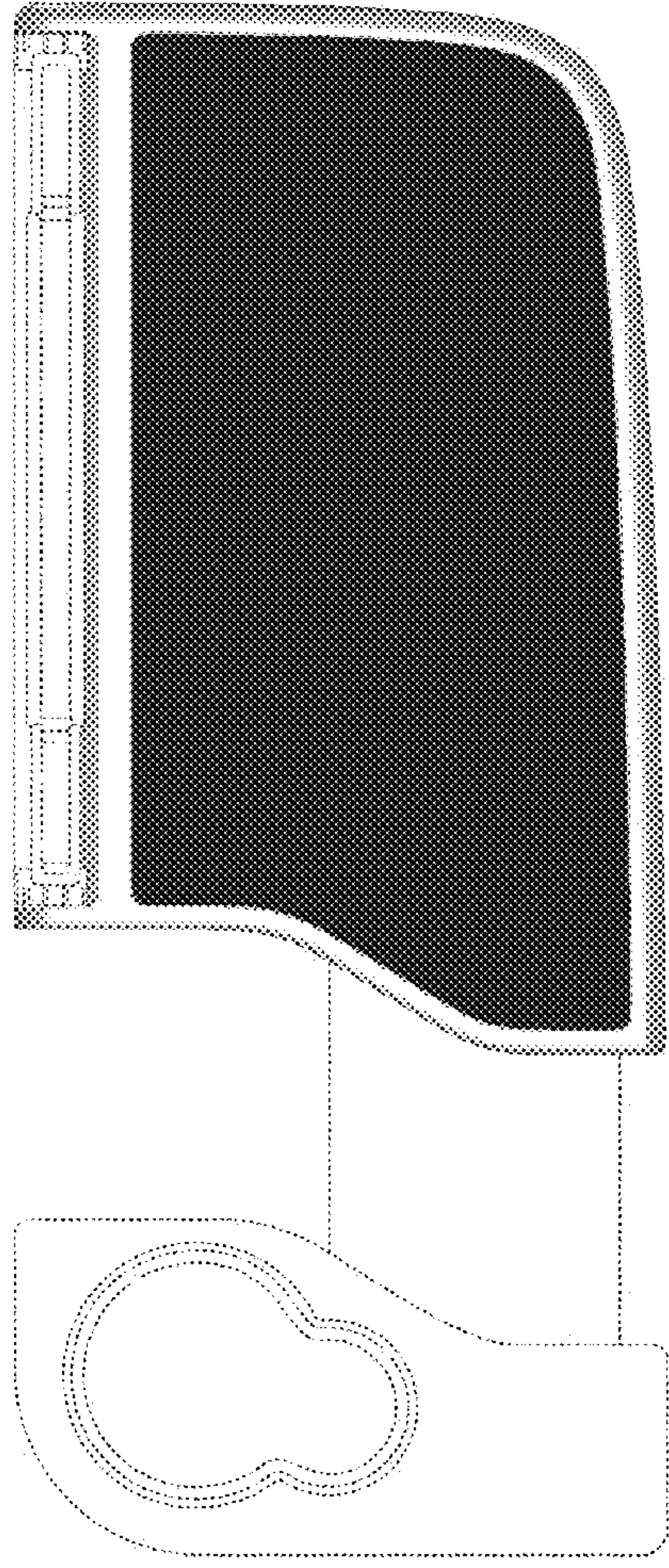

FIG. 6

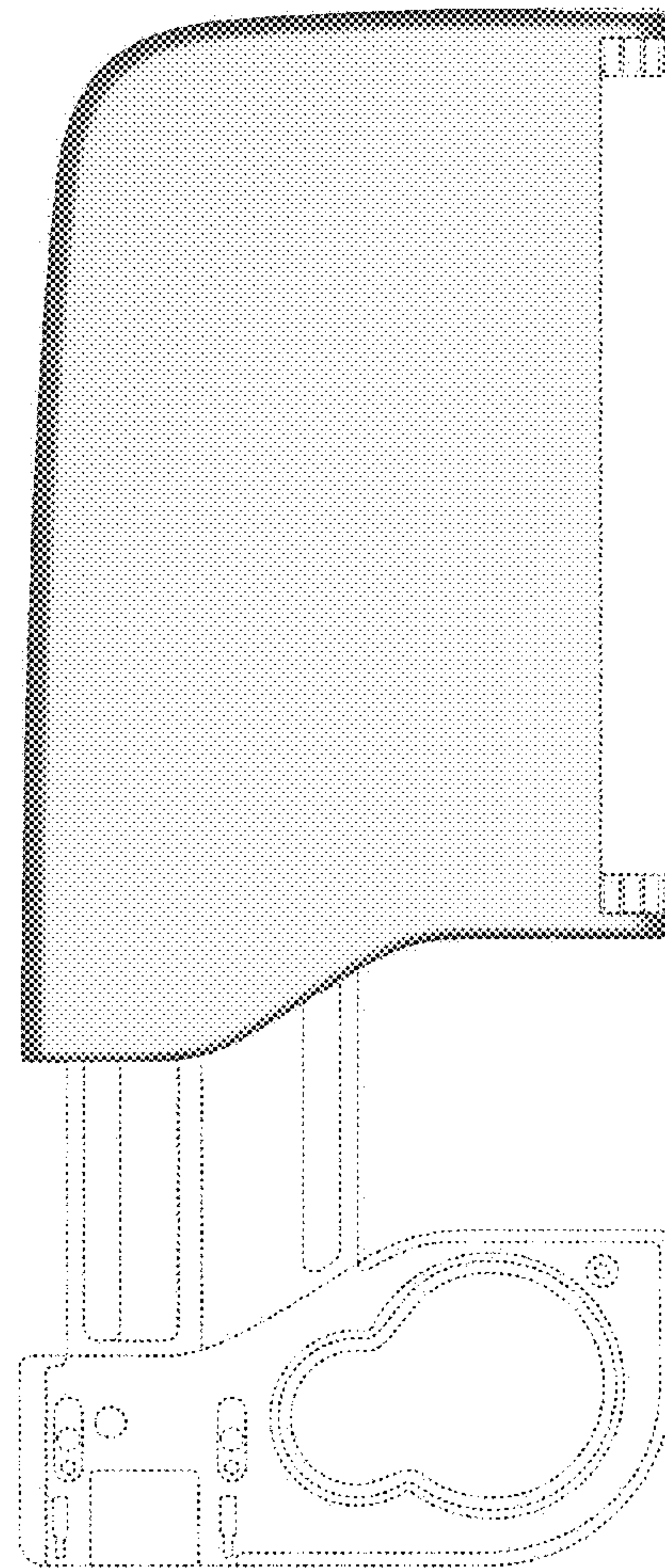

FIG. 7

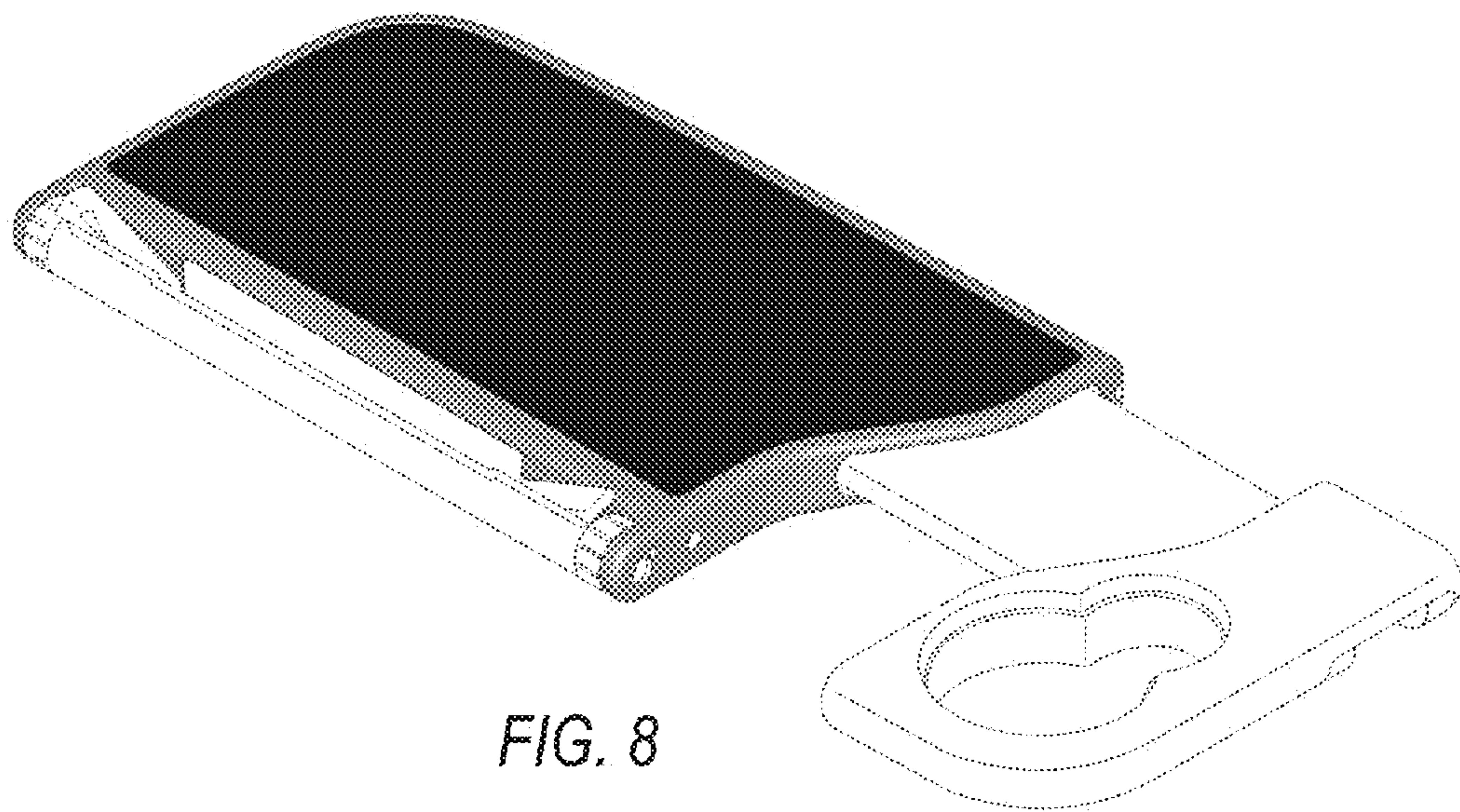

FIG. 8

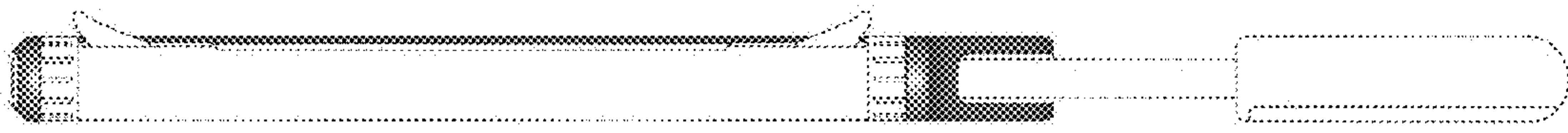

FIG. 9

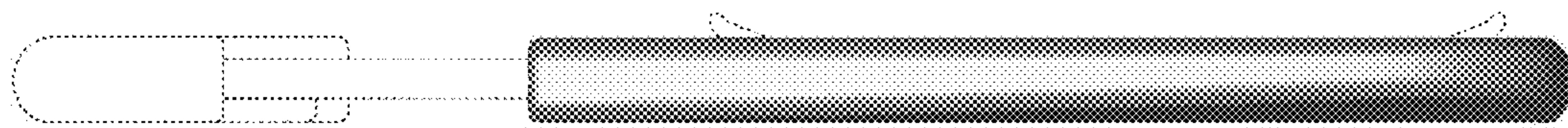

FIG. 10

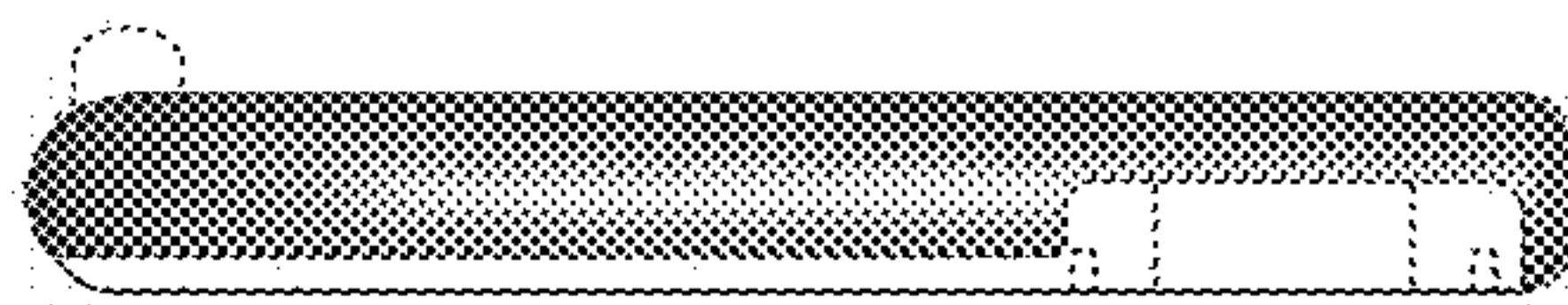

FIG. 11

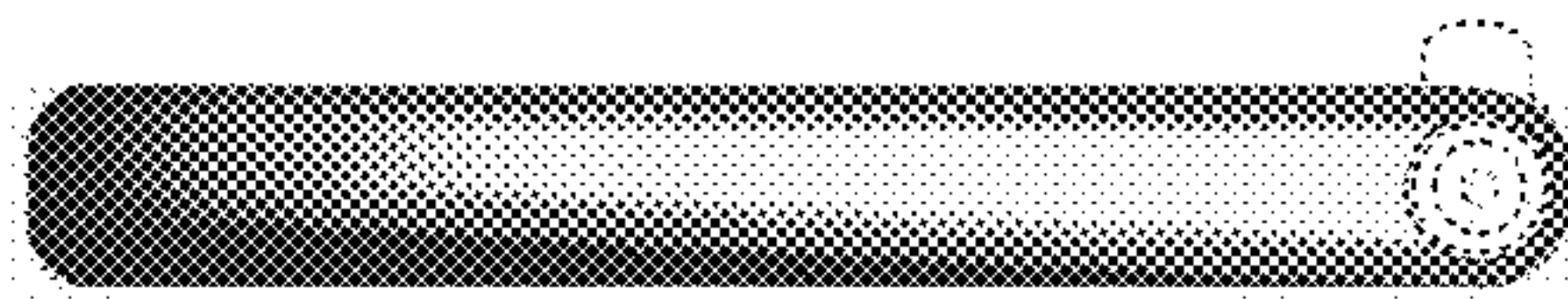

FIG. 12



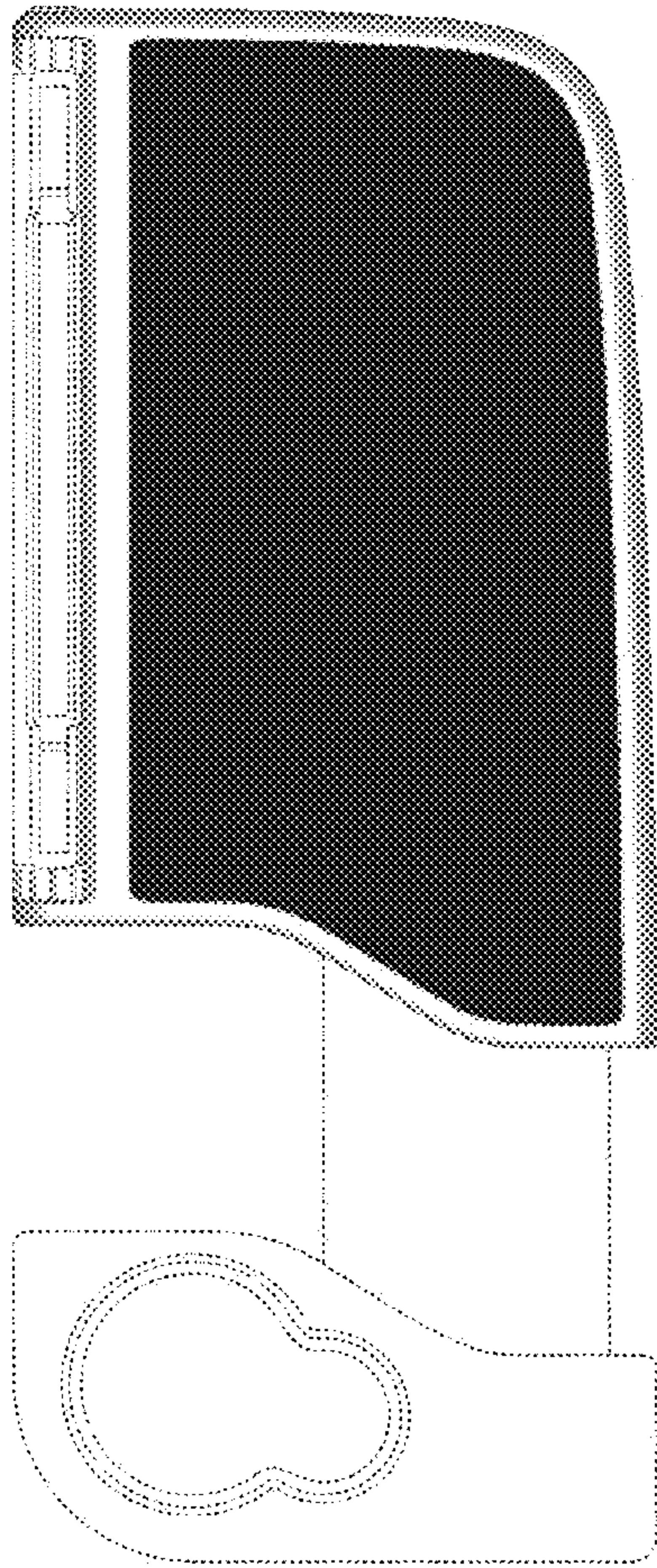

FIG. 13

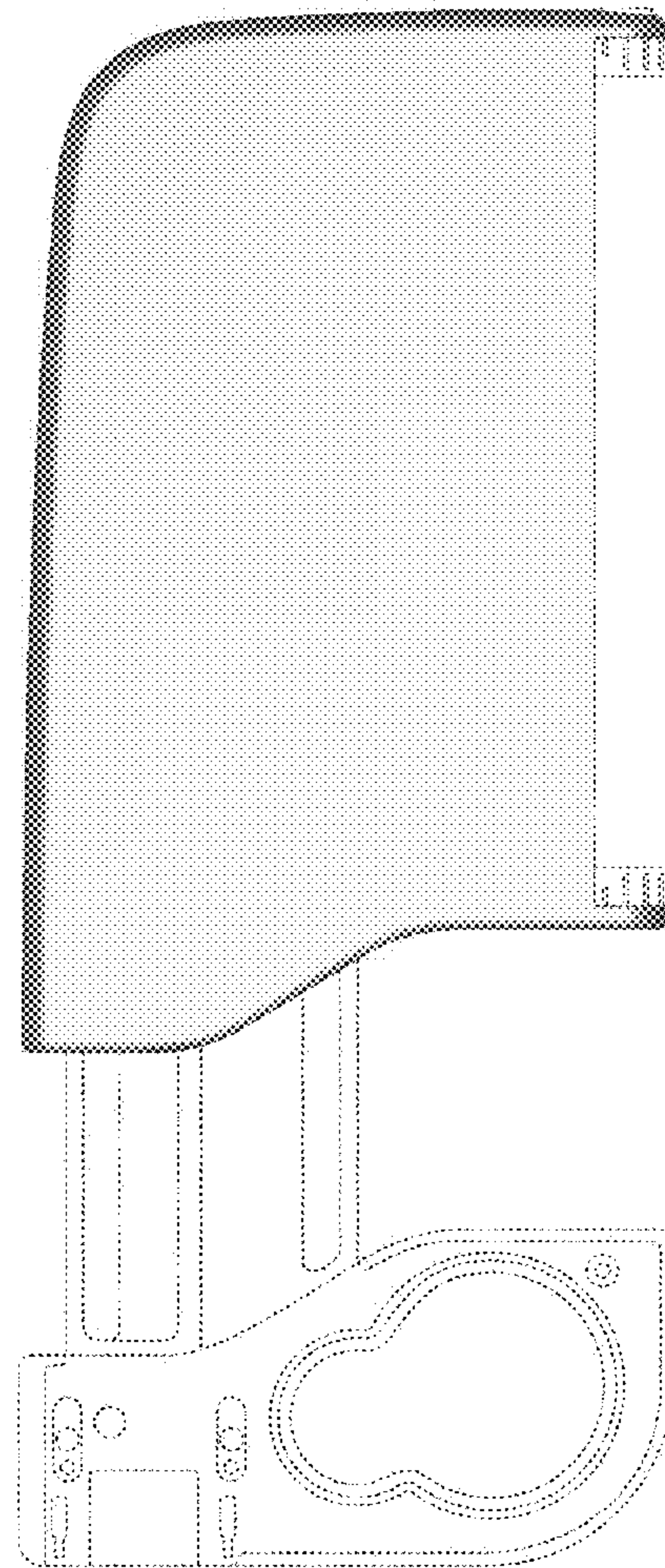

FIG. 14



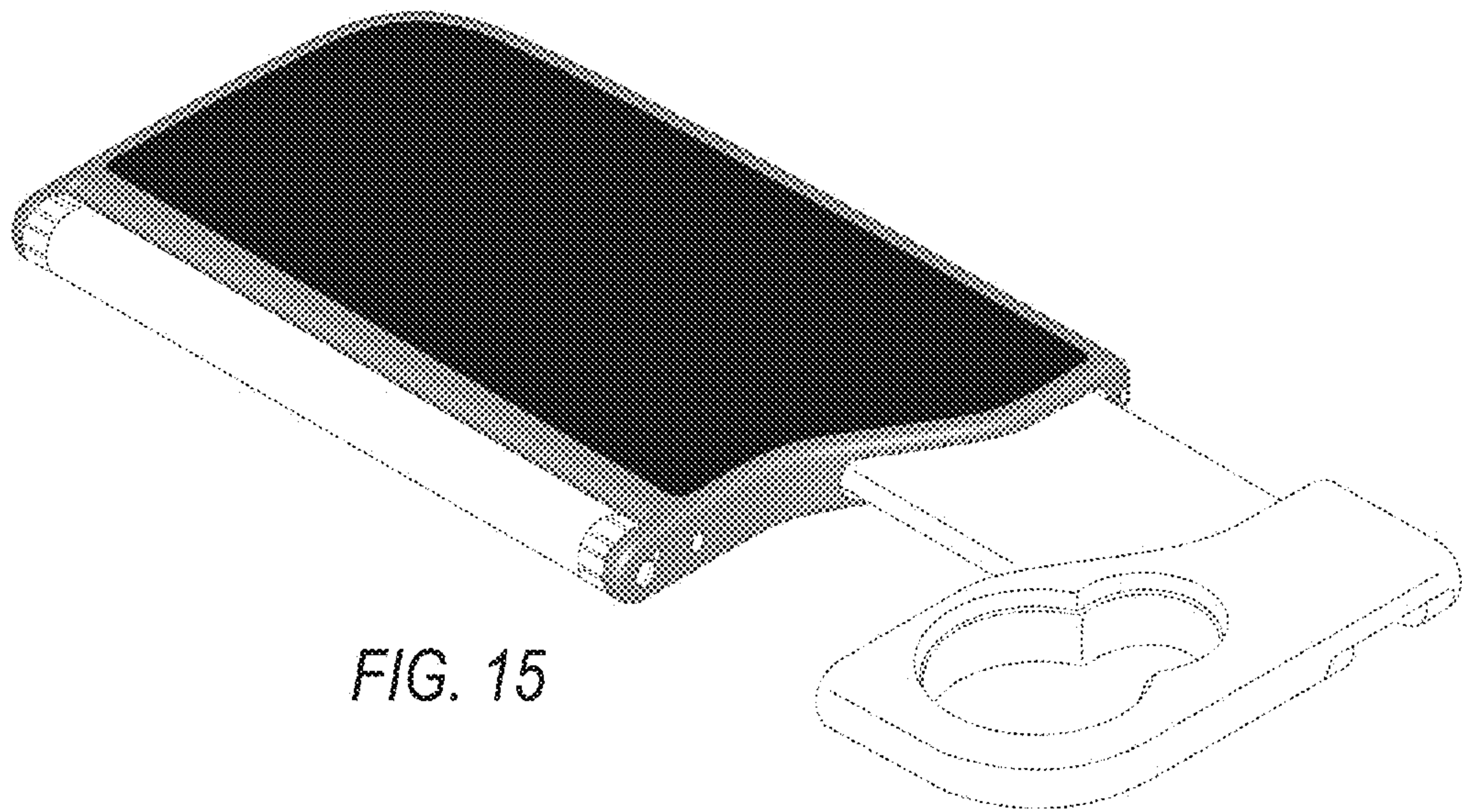

FIG. 15



FIG. 16

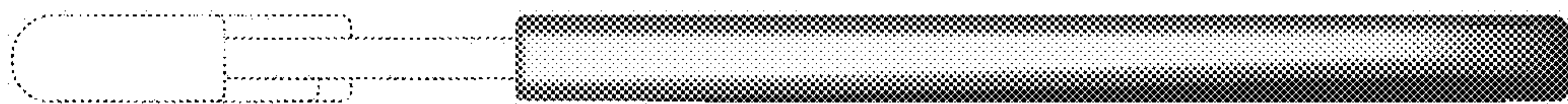

FIG. 17

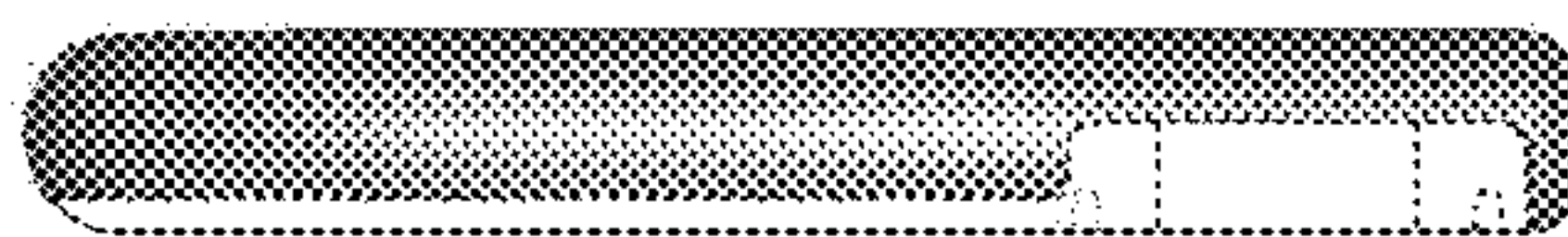

FIG. 18

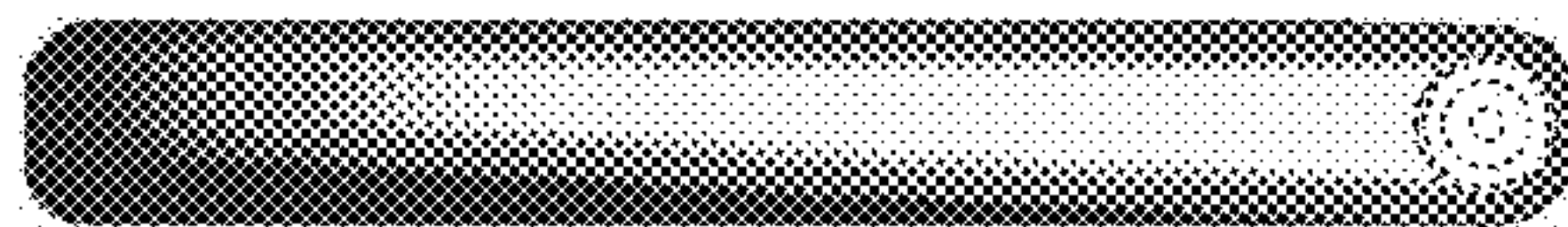

FIG. 19

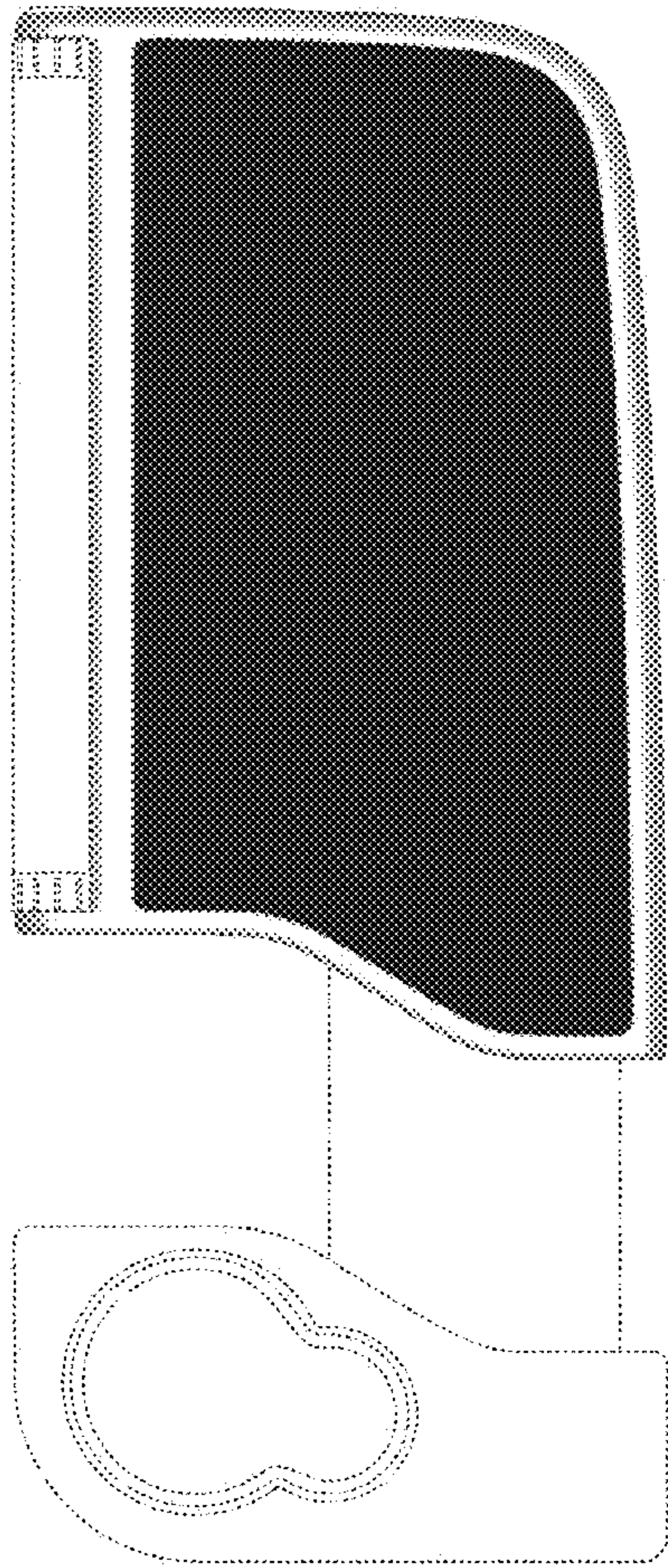

FIG. 20

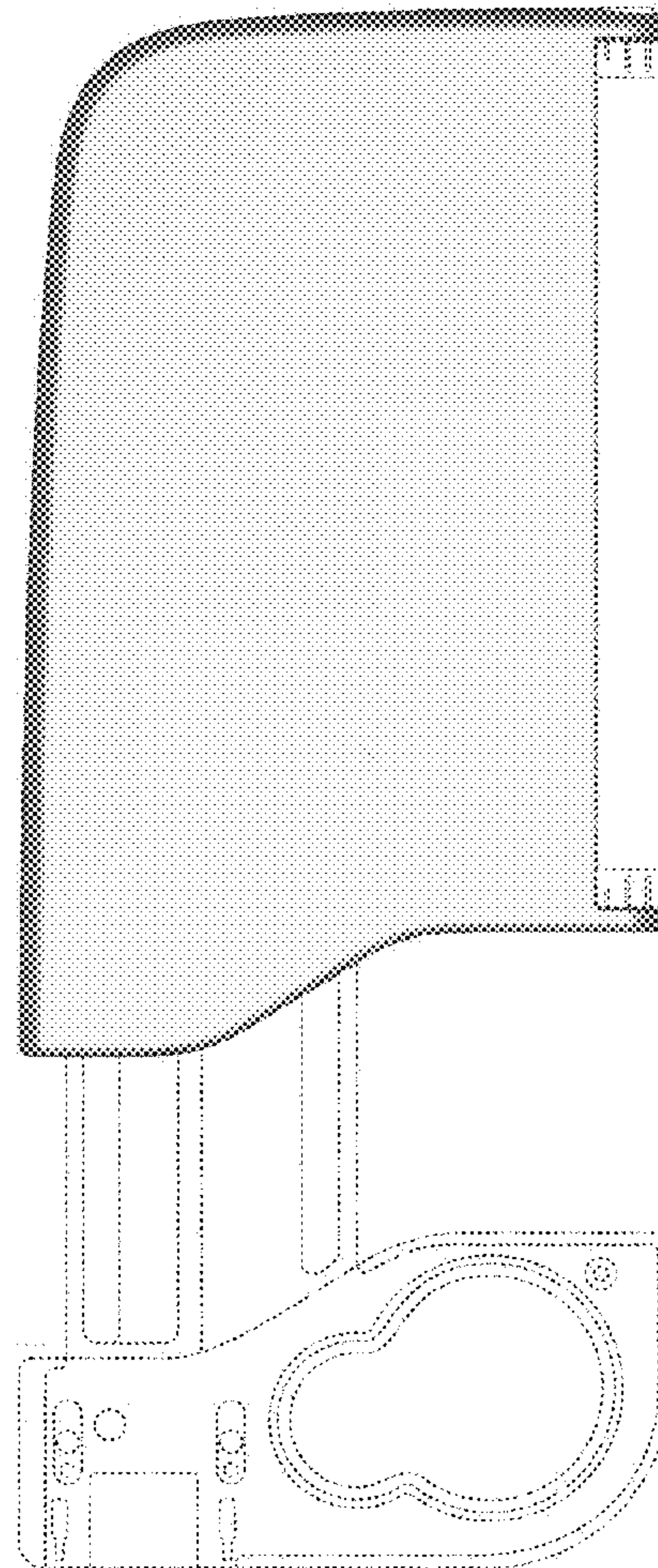

FIG. 21

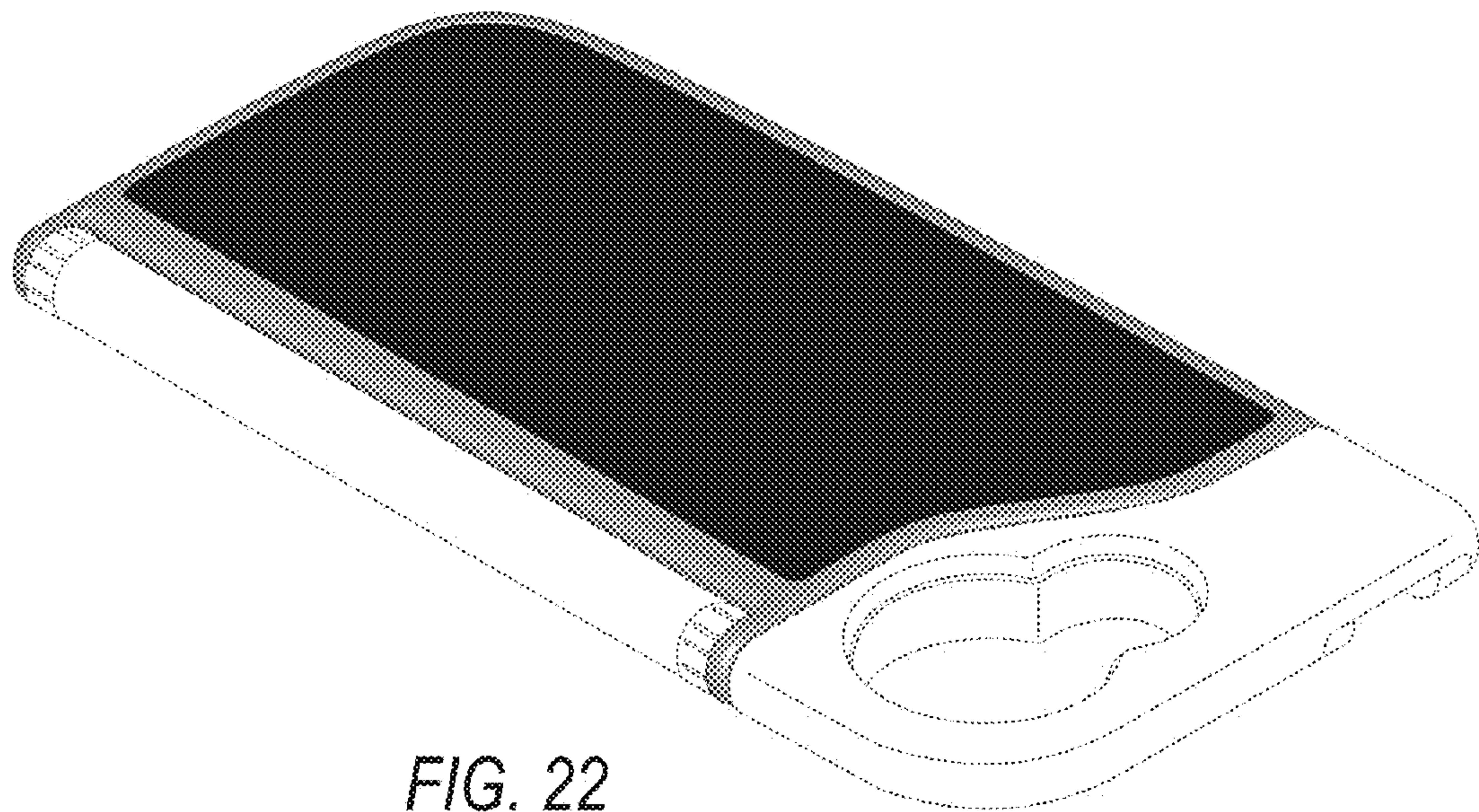

FIG. 22





FIG. 23

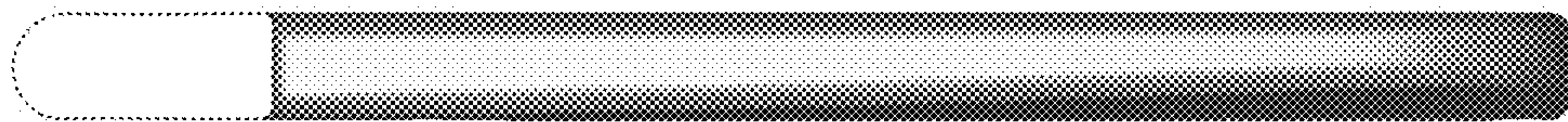

FIG. 24

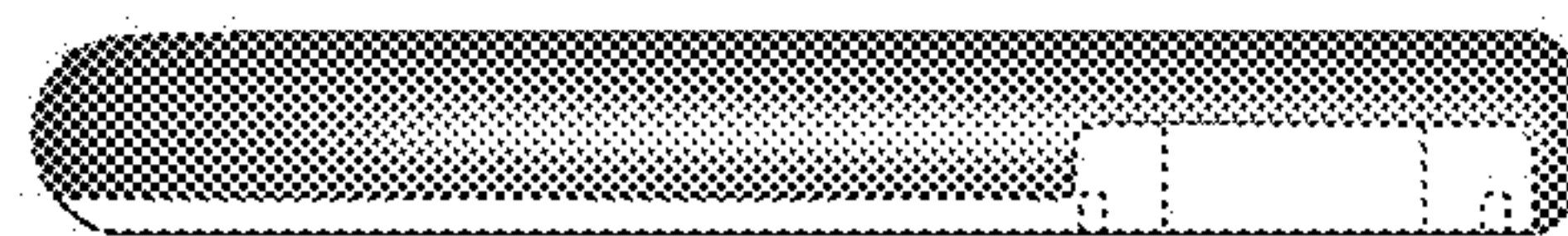

FIG. 25

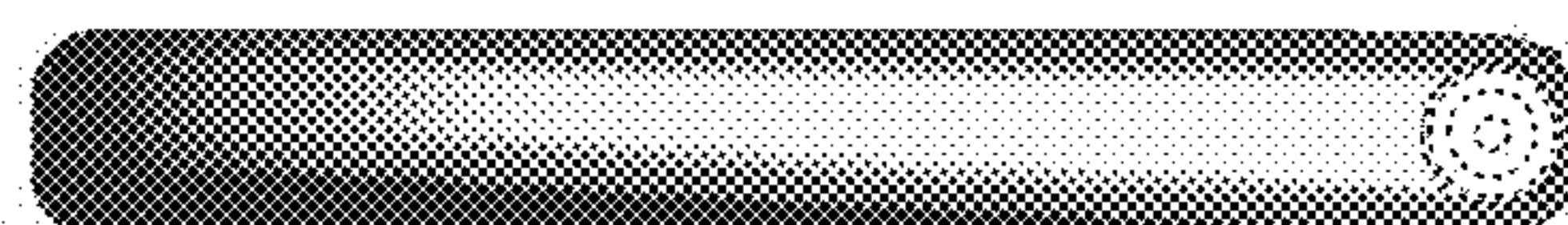

FIG. 26

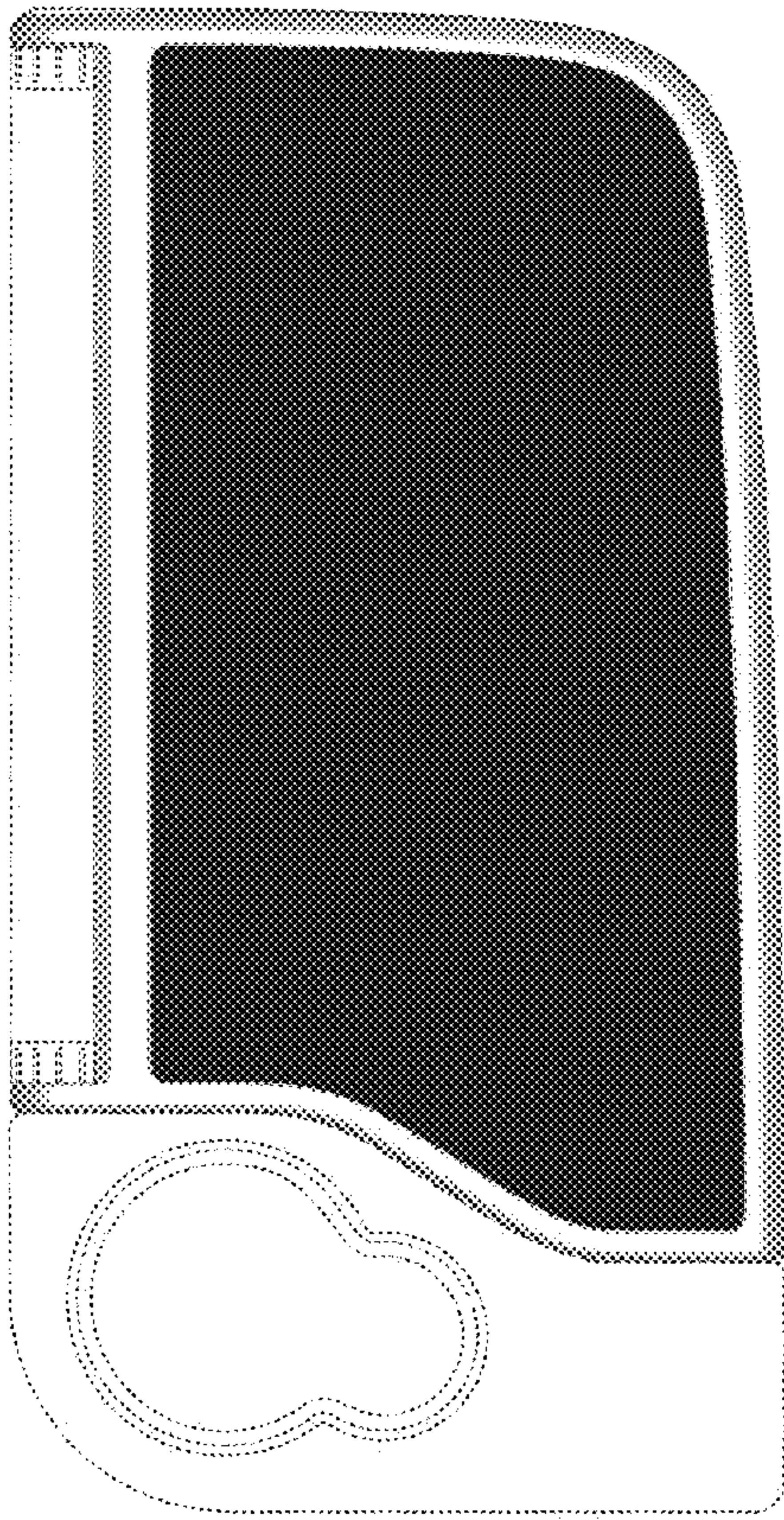

FIG. 27

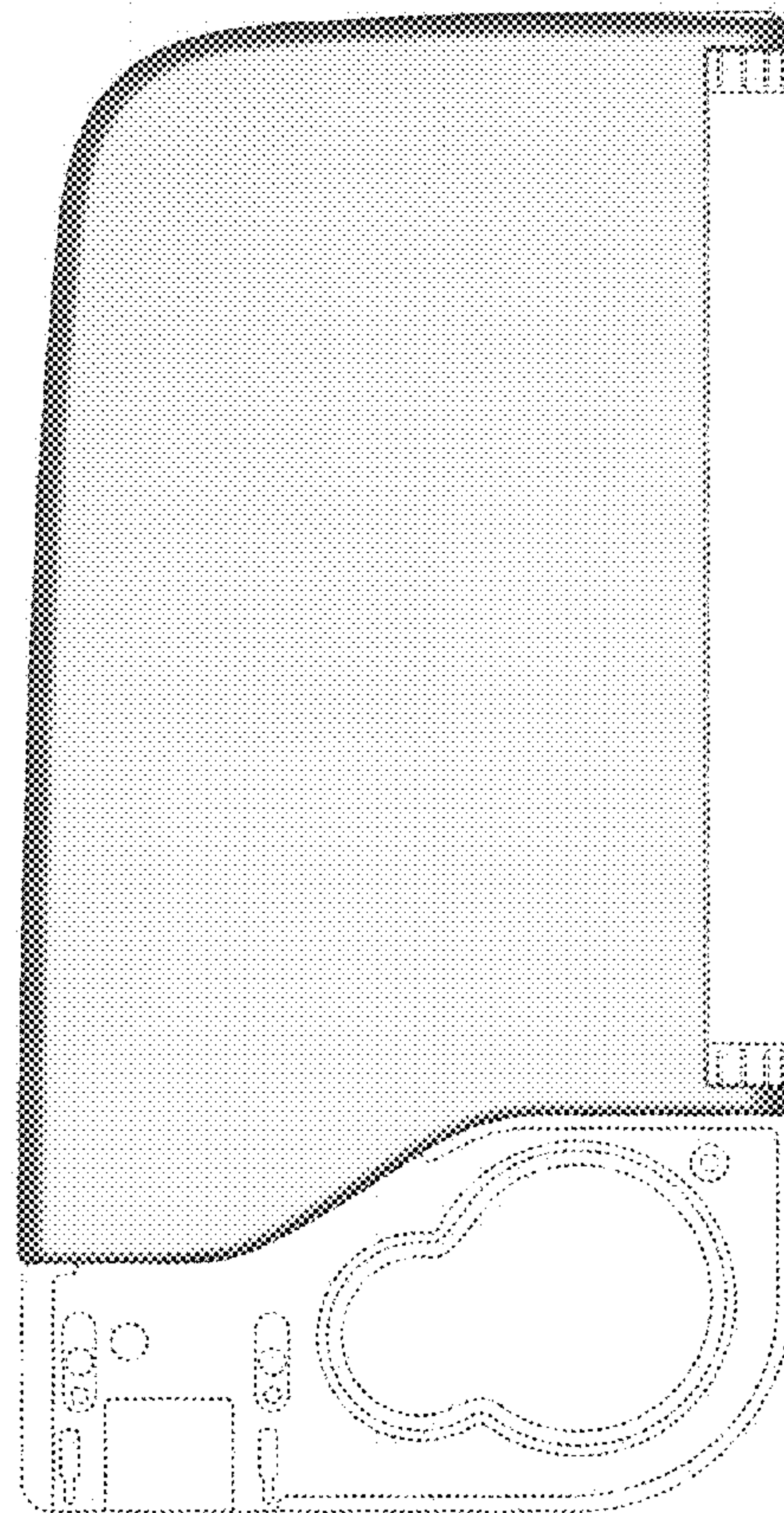

FIG. 28

