



US00D753447S

(12) **United States Design Patent**
Busboom

(10) **Patent No.:** **US D753,447 S**
(45) **Date of Patent:** **** Apr. 12, 2016**

(54) **INTERLOCKING UTENSIL**

(71) Applicant: **Jeffrey K. Busboom**, Sparks, NV (US)

(72) Inventor: **Jeffrey K. Busboom**, Sparks, NV (US)

(**) Term: **14 Years**

(21) Appl. No.: **29/511,942**

(22) Filed: **Dec. 15, 2014**

(51) **LOC (10) Cl.** **07-03**

(52) **U.S. Cl.**

USPC **D7/644**; D7/642; D7/643; D7/653

(58) **Field of Classification Search**

USPC D7/368, 401.2, 642–645, 653–664, 669,
D7/675–677, 683, 688–689, 691; D8/107,
D8/300–301; D22/117–118

CPC A01D 9/02; A01D 9/04; A01D 9/06;
A47G 21/00; A47G 21/004; A47G 21/005;
A47G 21/02; A47G 21/023; A47G 21/04;
A47G 21/06; A47G 21/08; A47J 43/28;
A47J 43/281; A47J 43/282; A61F 13/10;
A61J 7/0023; B25G 1/00; B25G 1/01; B25G
1/02; B25G 3/00; B65D 75/56; B65D 75/563;
B65D 75/566; B67B 7/00; B67B 7/38; B67B
7/724; B67B 7/73

See application file for complete search history.

(56) **References Cited**

U.S. PATENT DOCUMENTS

398,264	A *	2/1889	Kisner	A47G 21/02 30/150
671,740	A *	4/1901	Wattne	B67B 7/38 30/148
854,745	A *	5/1907	King	A47G 21/02 30/150
972,777	A *	10/1910	Richardson	A47G 21/06 30/147
1,229,696	A *	6/1917	Woods	B26B 11/00 30/143
1,372,325	A *	3/1921	Willemin	A47G 21/06 30/143

(Continued)

Primary Examiner — Ricky Pham

(74) *Attorney, Agent, or Firm* — R. Tracy Crump

(57) **CLAIM**

I claim the ornamental design of an interlocking utensil, as shown and described.

DESCRIPTION

FIG. 1 is a perspective view of an interlocking utensil (a spoon component and fork component connected together in a stowed position) showing my design;

FIG. 2 is a top view thereof;

FIG. 3 is a bottom view thereof;

FIG. 4 is a right side view thereof;

FIG. 5 is a left side thereof;

FIG. 6 is an enlarged rear view thereof;

FIG. 7 is an enlarged front view thereof;

FIG. 8 is a perspective view of an interlocking utensil (a spoon component and fork component connected together in a “spork” position) showing my design;

FIG. 9 is a top view thereof;

FIG. 10 is a bottom view thereof;

FIG. 11 is a right side view thereof;

FIG. 12 is a left side thereof;

FIG. 13 is an enlarged front view thereof;

FIG. 14 is an enlarged rear view thereof;

FIG. 15 is a perspective view of the fork component of the interlocking utensil showing my design;

FIG. 16 is a top view thereof;

FIG. 17 is a bottom view thereof;

FIG. 18 is a right side view thereof;

FIG. 19 is a left side thereof;

FIG. 20 is an enlarged front view thereof;

FIG. 21 is an enlarged rear view thereof;

FIG. 22 is a perspective view of the spoon component of the interlocking utensil showing my design;

FIG. 23 is a top view thereof;

FIG. 24 is a bottom view thereof;

FIG. 25 is a right side view thereof;

FIG. 26 is a left side thereof;

FIG. 27 is an enlarged rear view thereof; and,

FIG. 28 is an enlarged front view thereof.

1 Claim, 20 Drawing Sheets

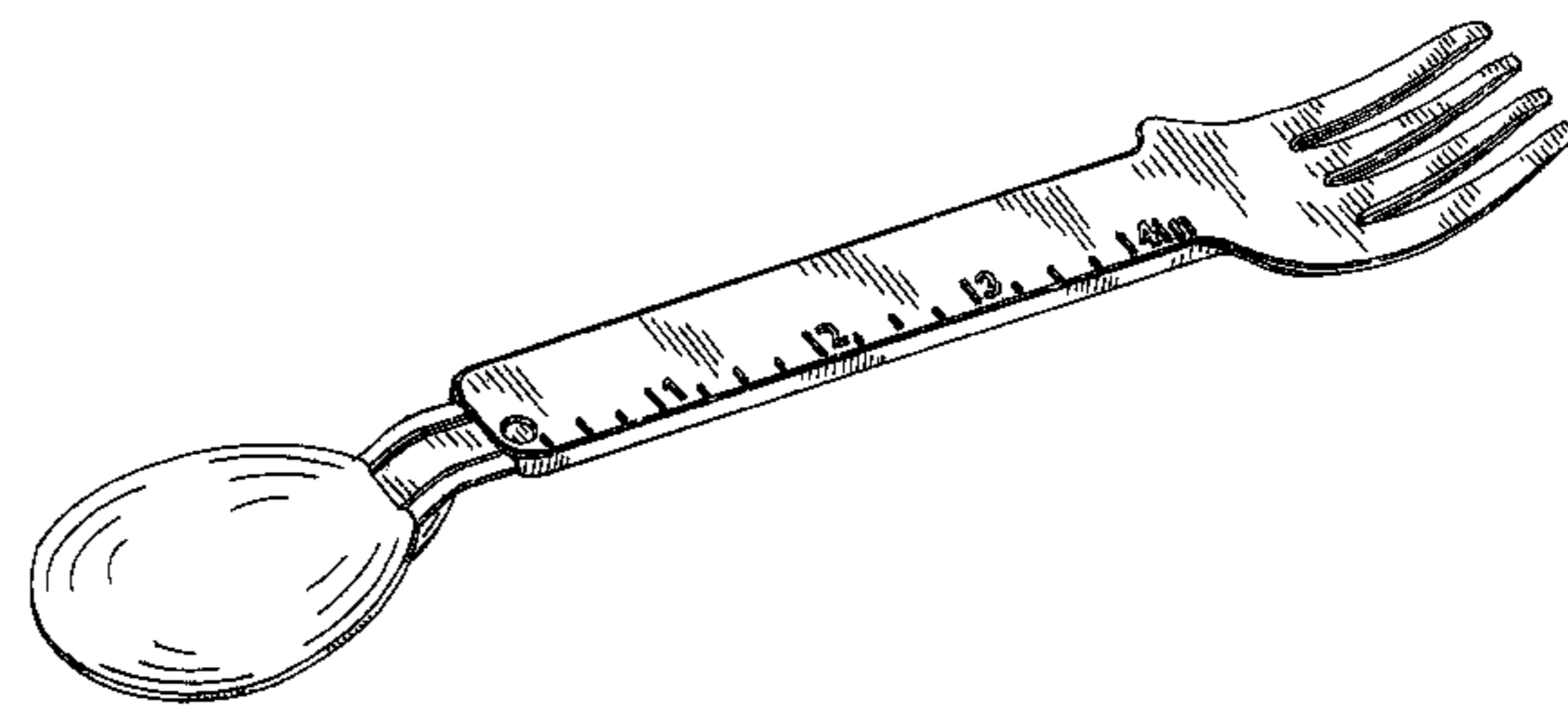
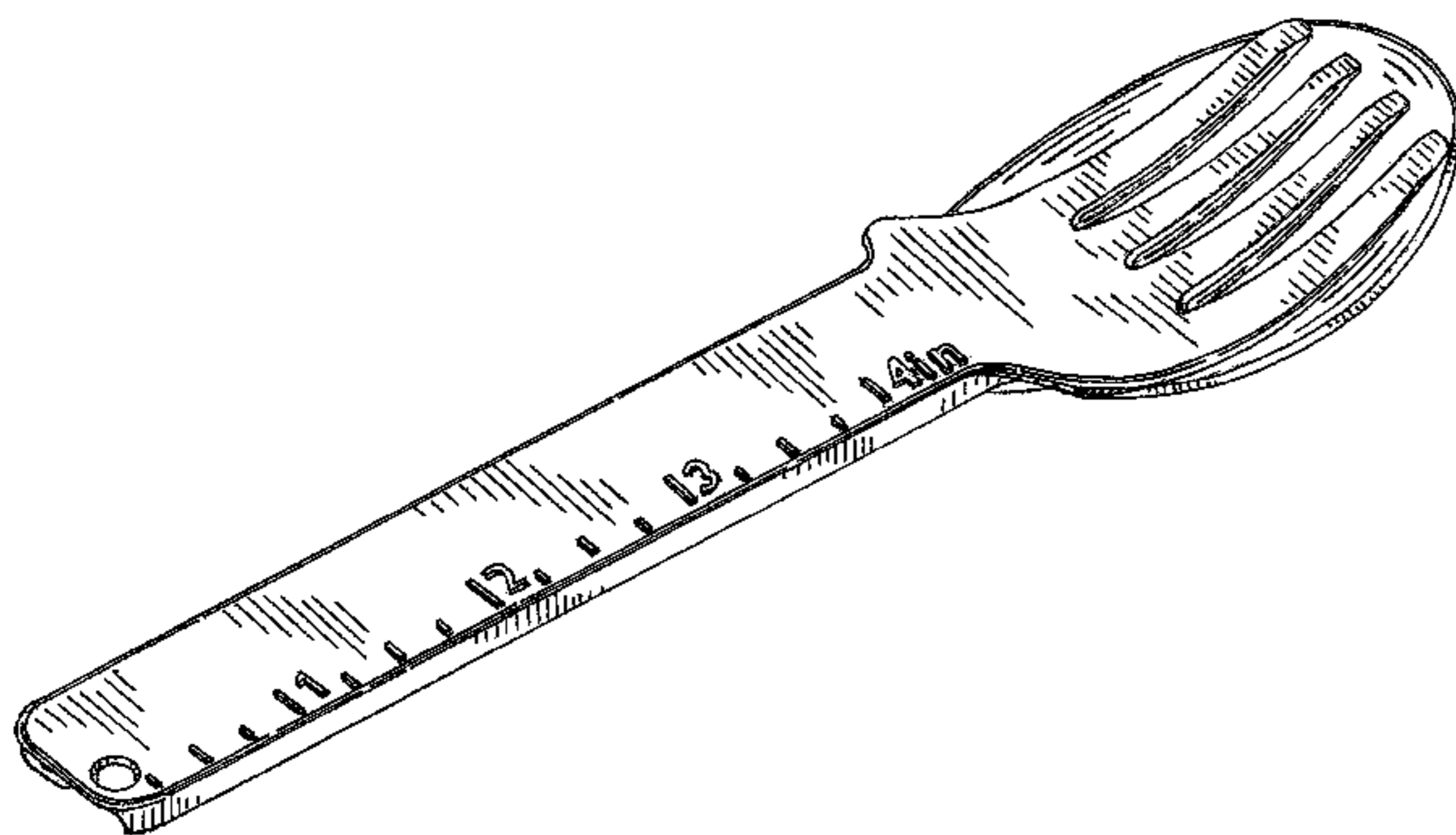

(56)

References Cited

U.S. PATENT DOCUMENTS

1,452,337 A * 4/1923 Brexel A47G 21/06
206/349
D414,988 S * 10/1999 Santini 30/150
D575,593 S * 8/2008 Svartstrom D7/644

D608,602 S * 1/2010 Davies D7/642
D656,799 S * 4/2012 Lebeau D7/644
D718,093 S * 11/2014 Miksovsky D7/643
D722,837 S * 2/2015 Miksovsky D7/643

* cited by examiner

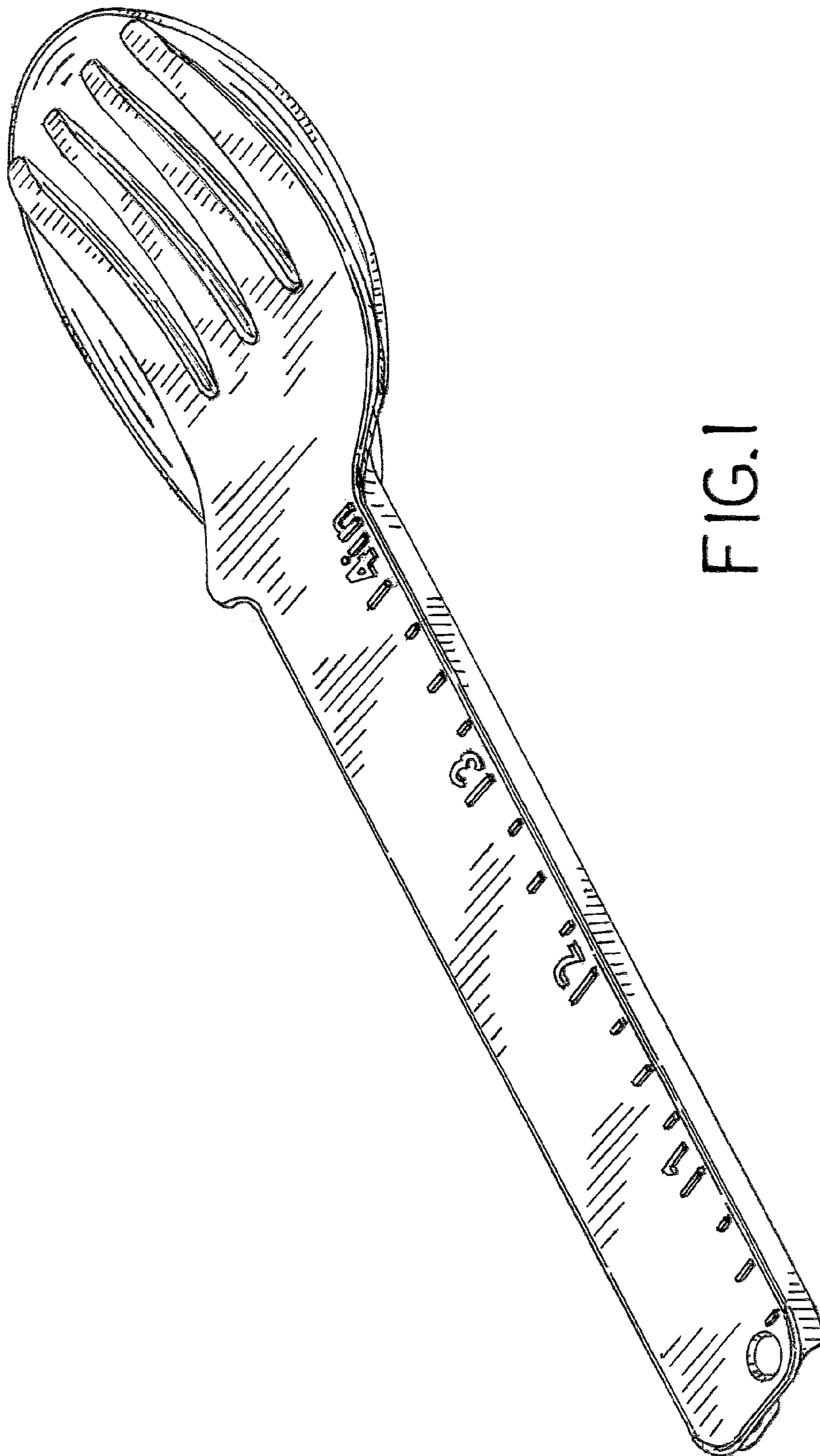

FIG. 1

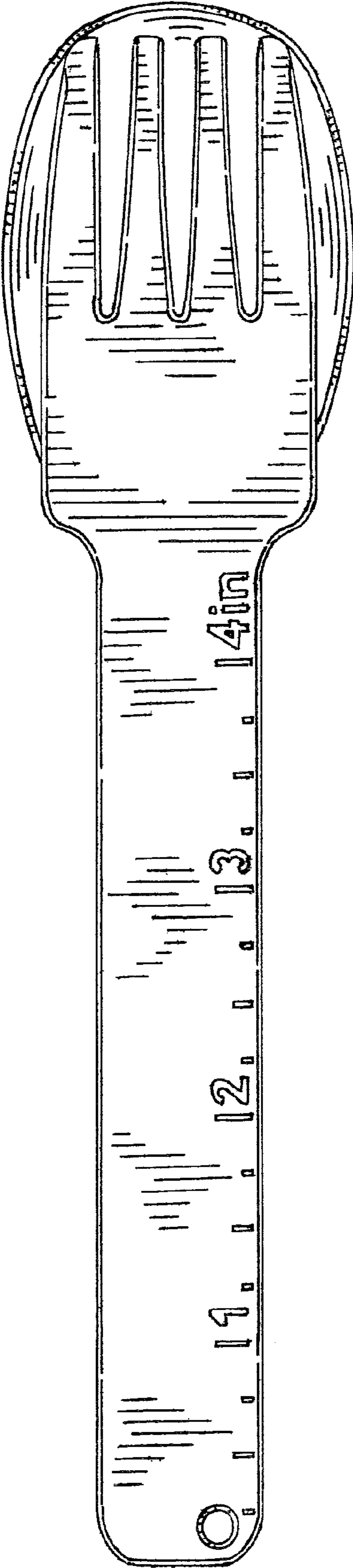

FIG. 2

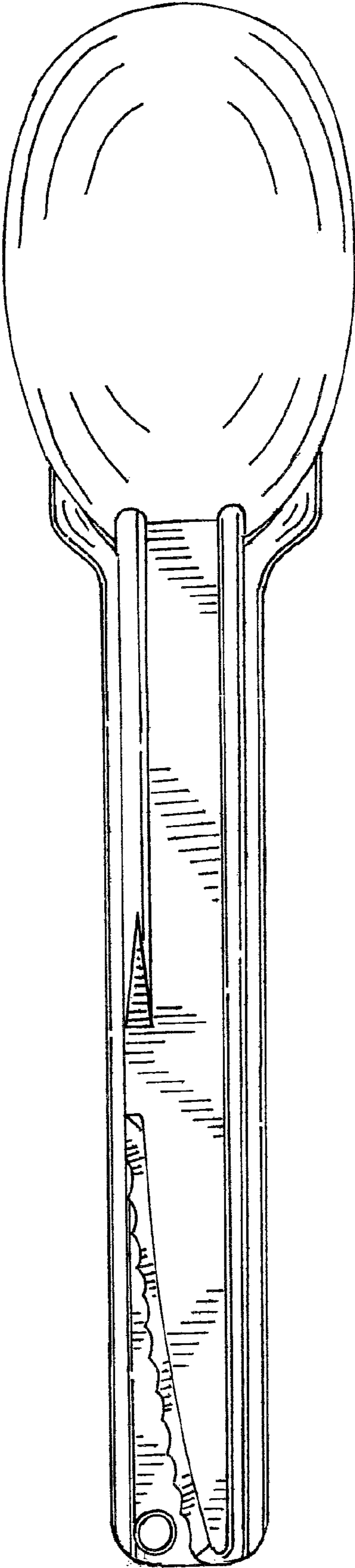

FIG. 3



FIG. 4

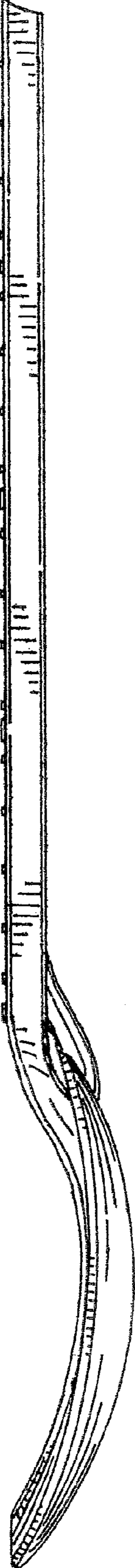

FIG. 5

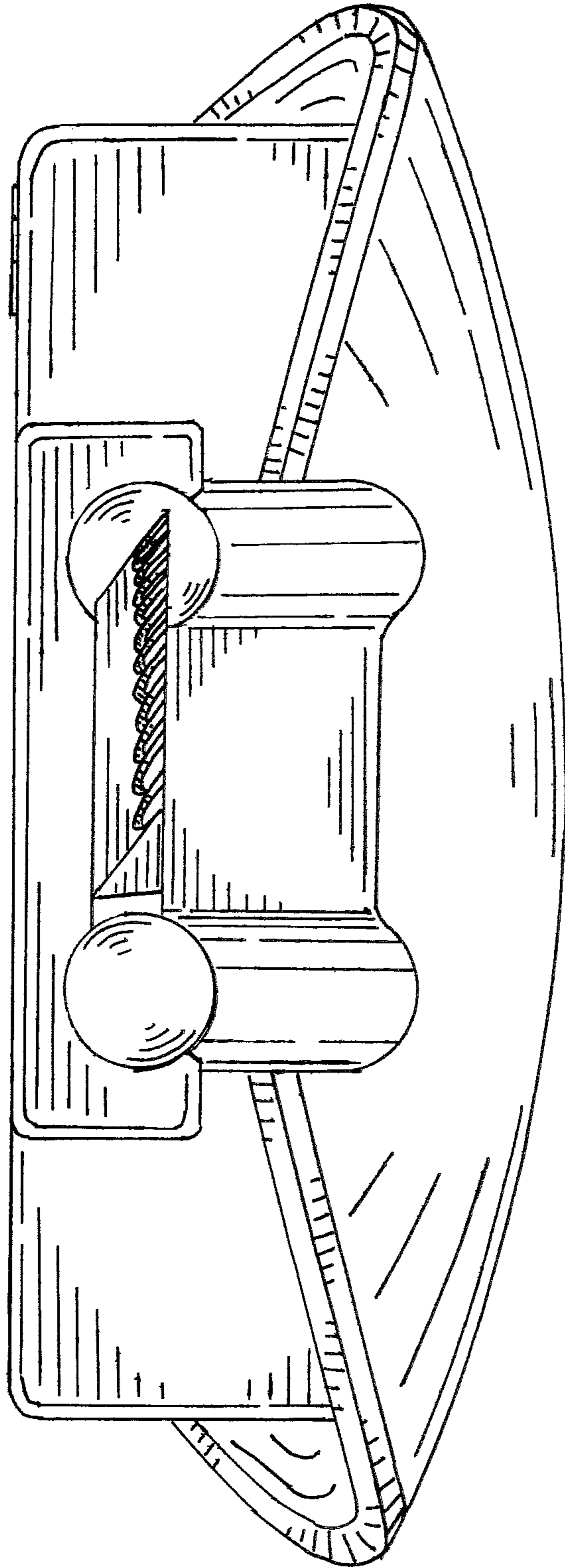

FIG. 6

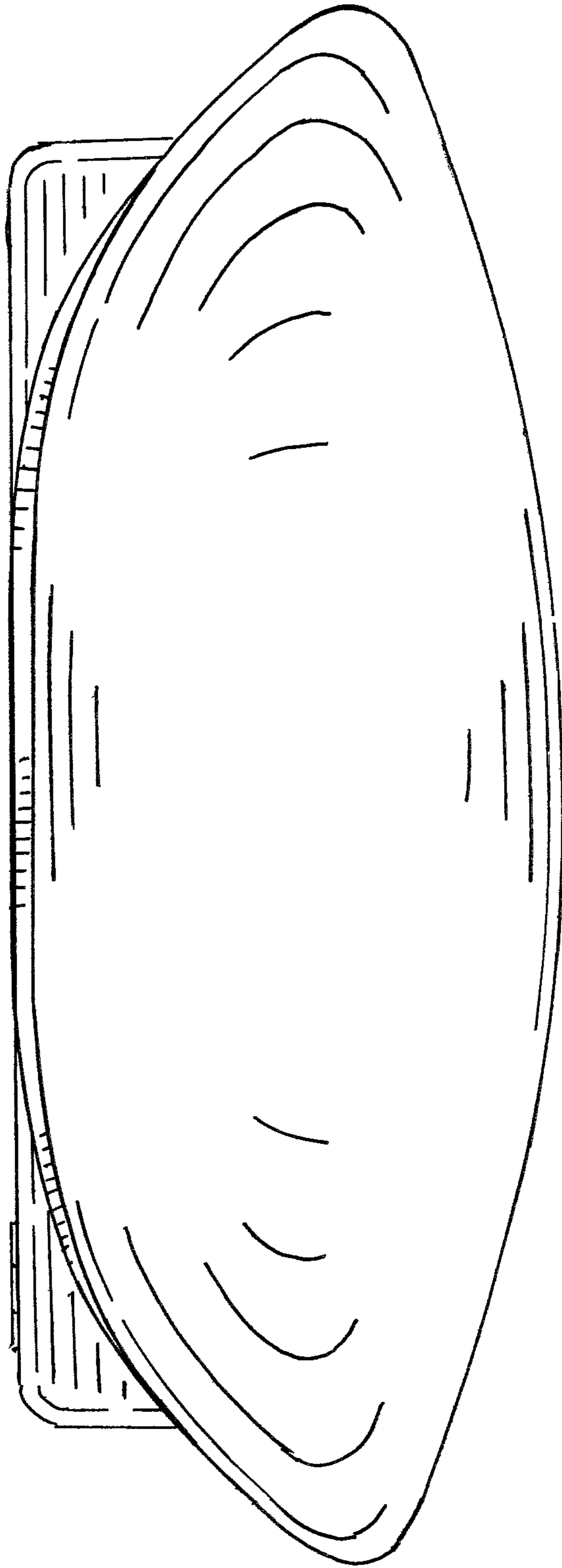

FIG. 7

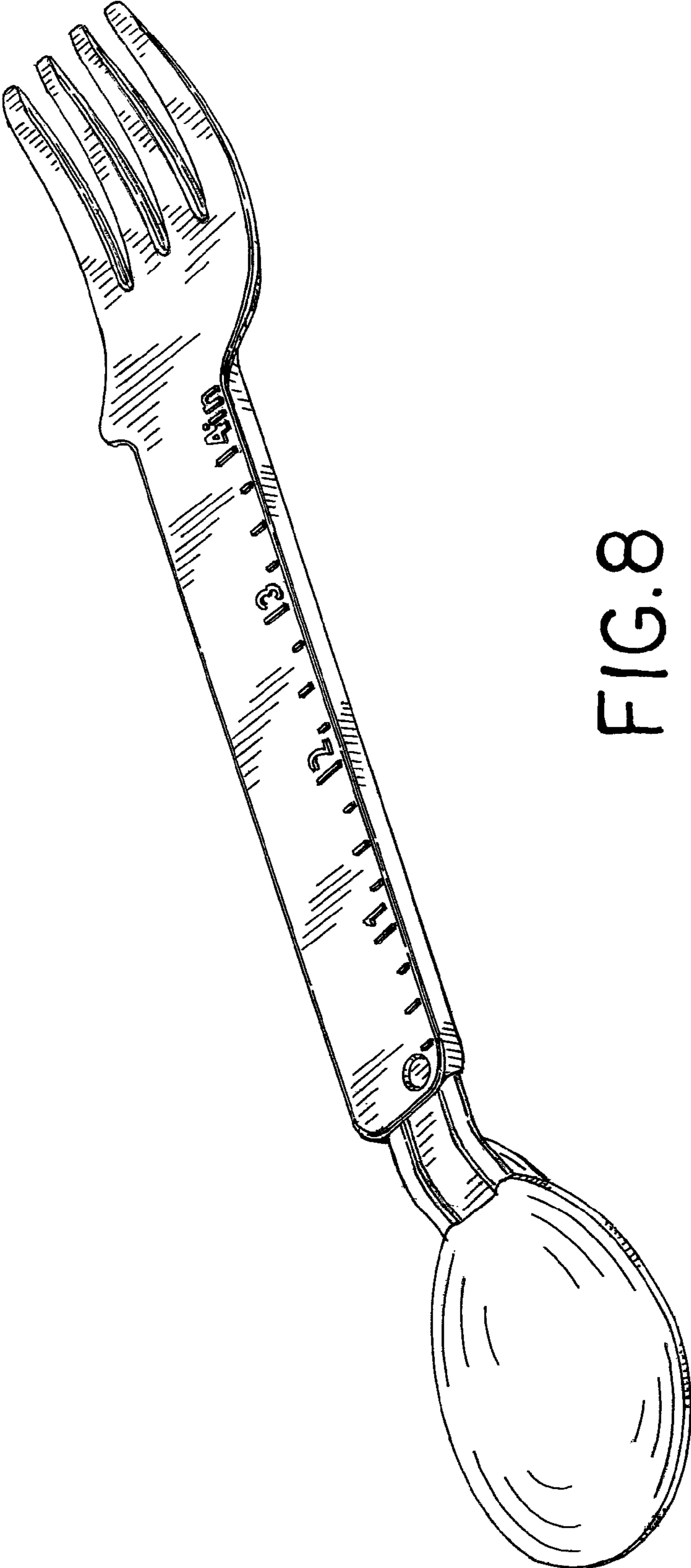

FIG. 8

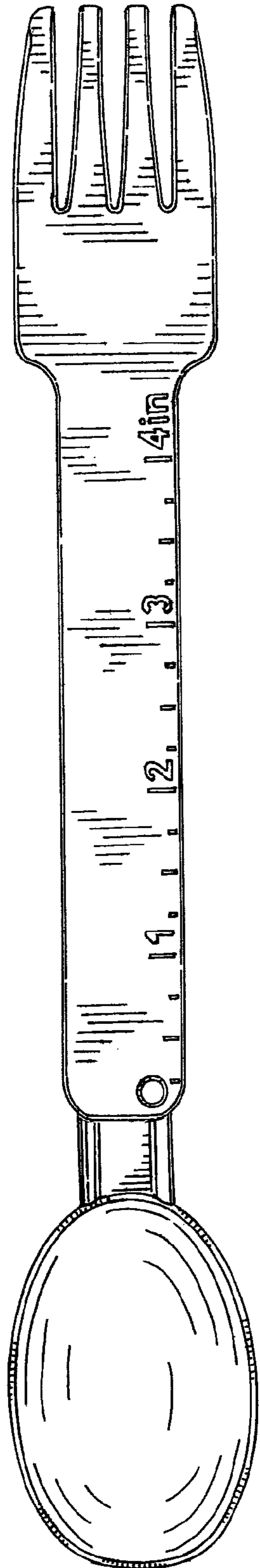

FIG. 9

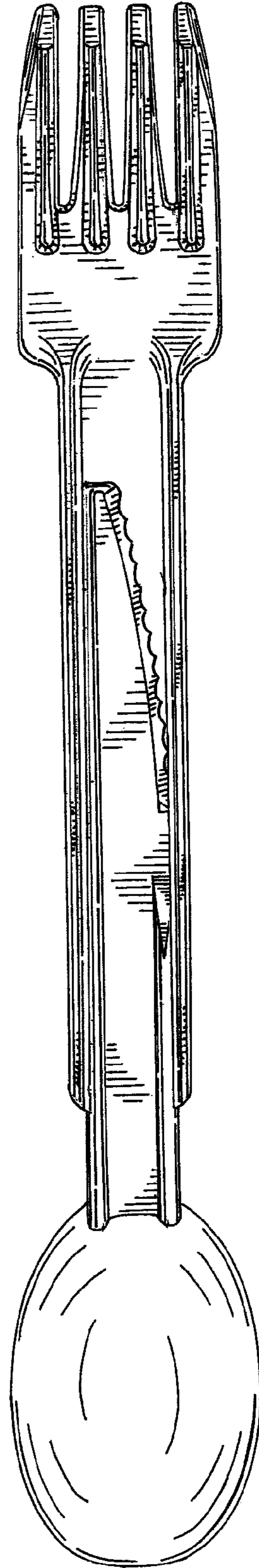

FIG. 10

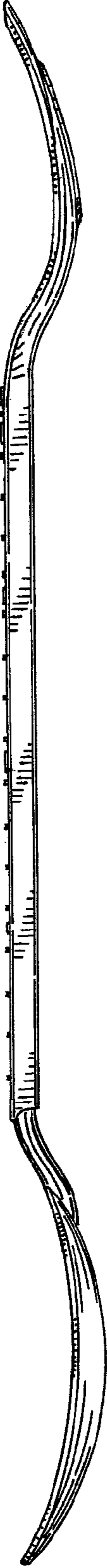

FIG. 11



FIG. 12

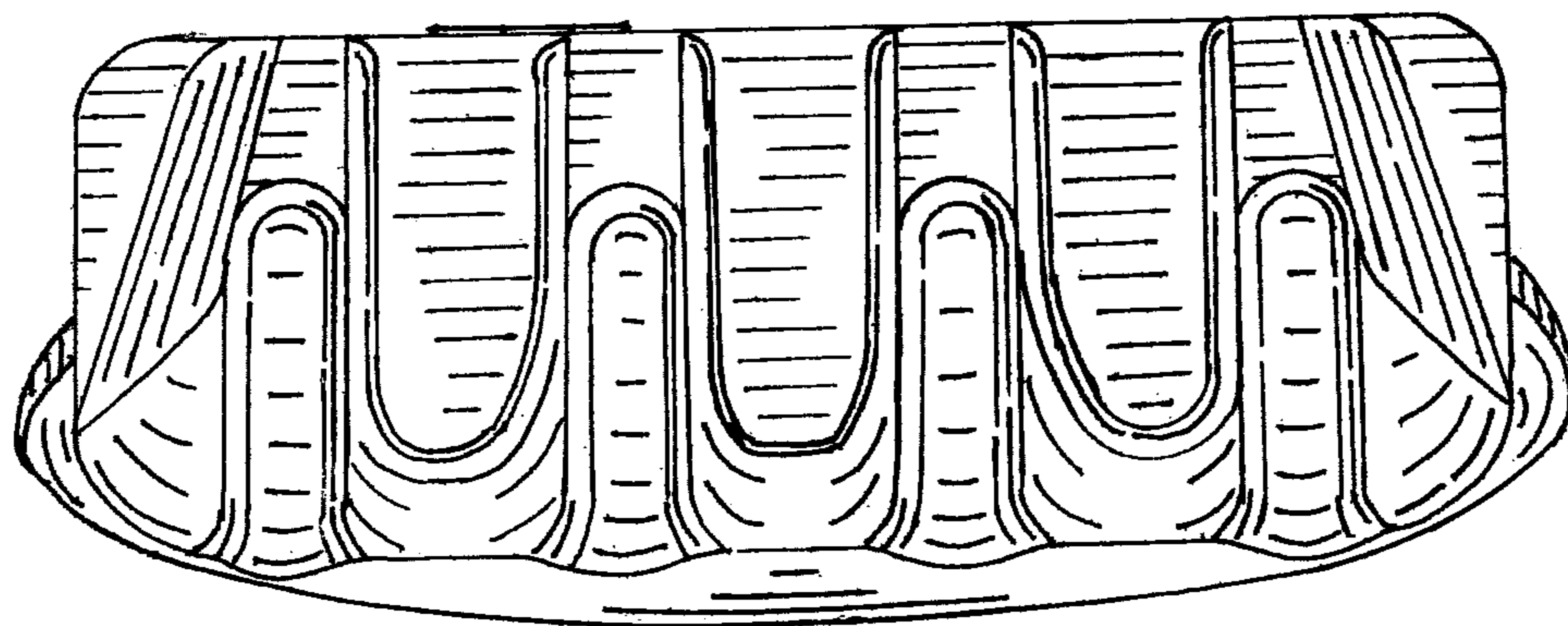

FIG. 13

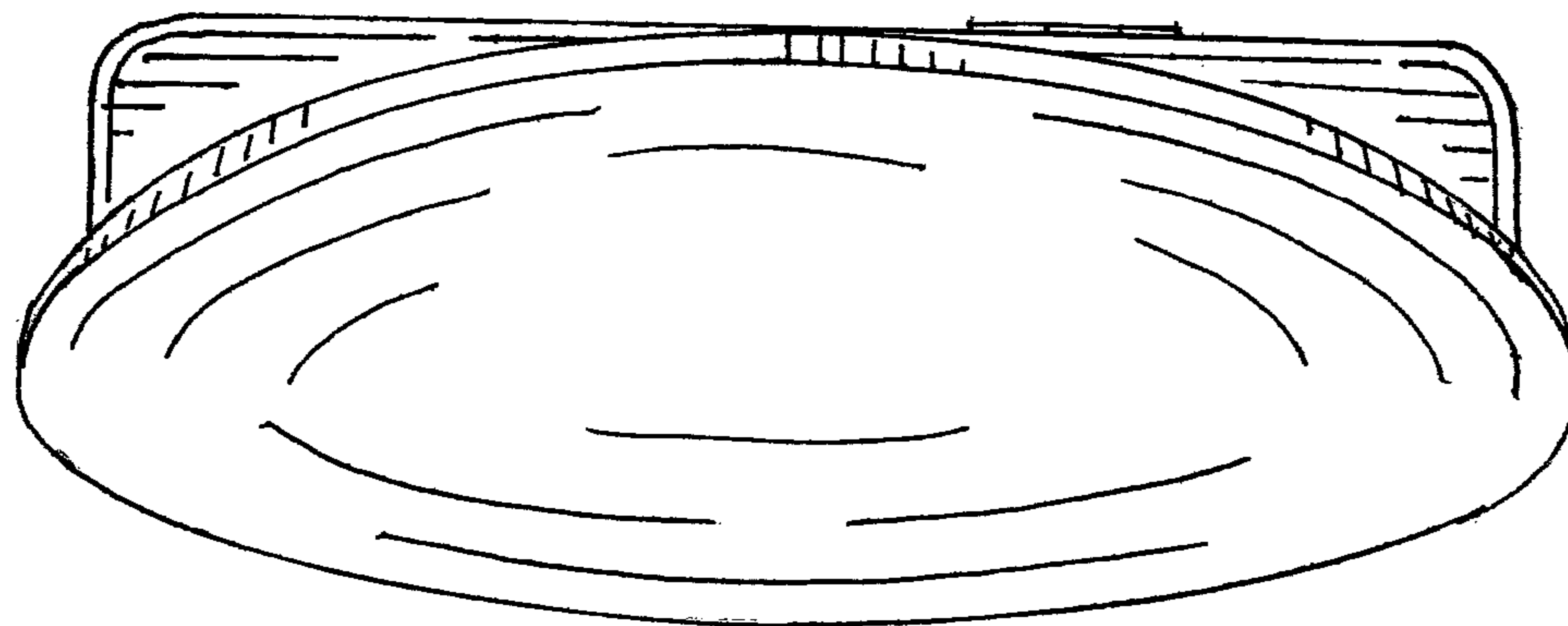

FIG. 14

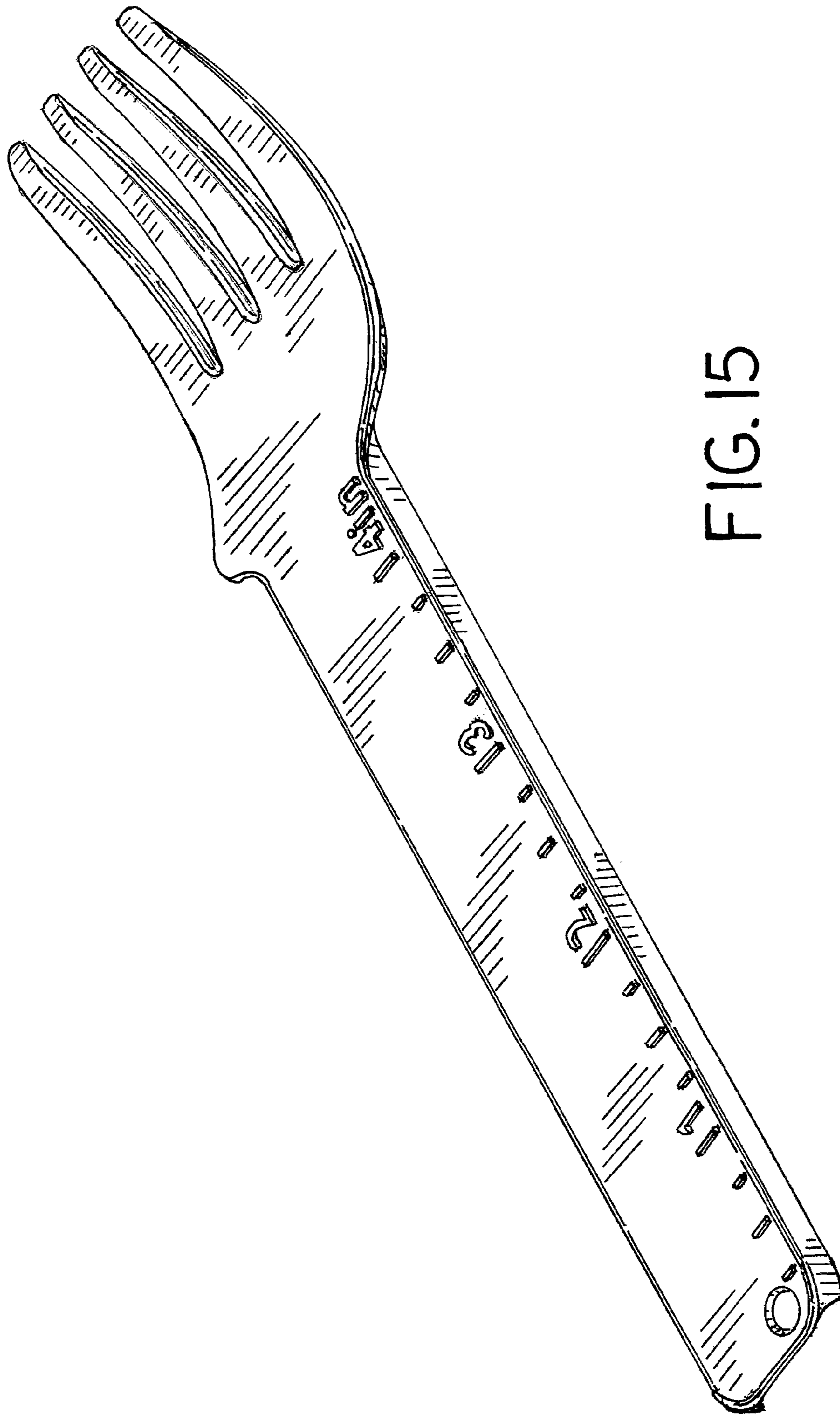

FIG. 15

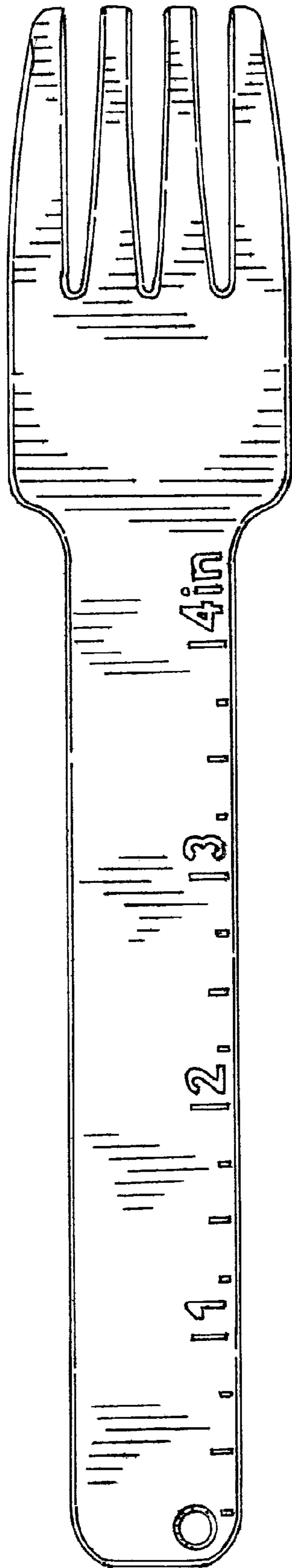

FIG. 16

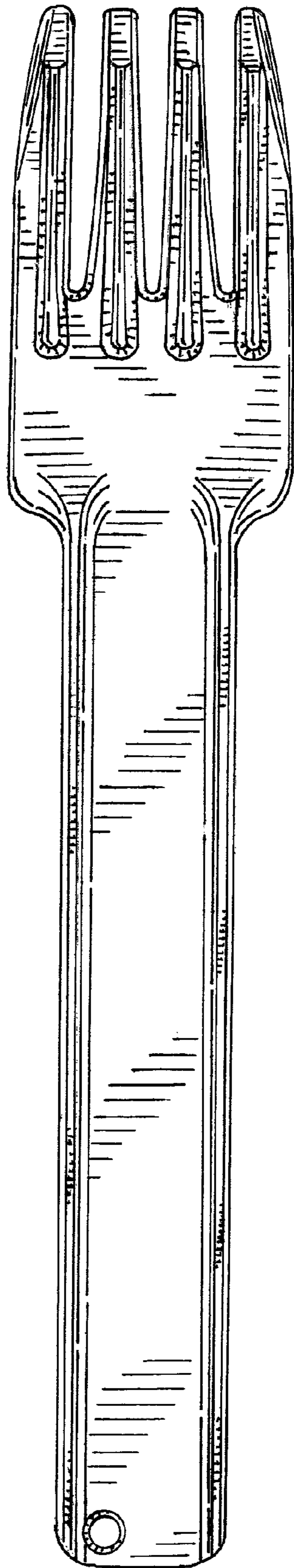

FIG.17

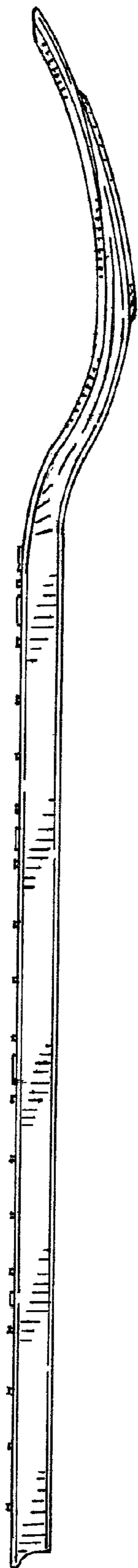

FIG. 18

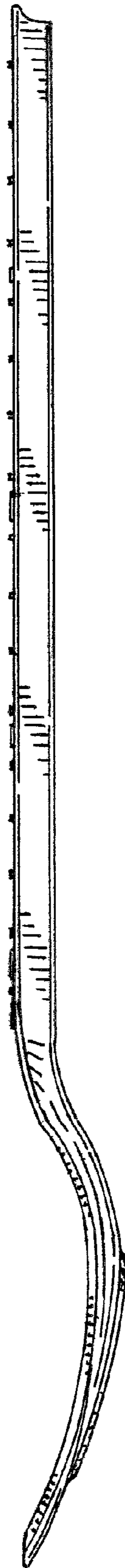

FIG. 19

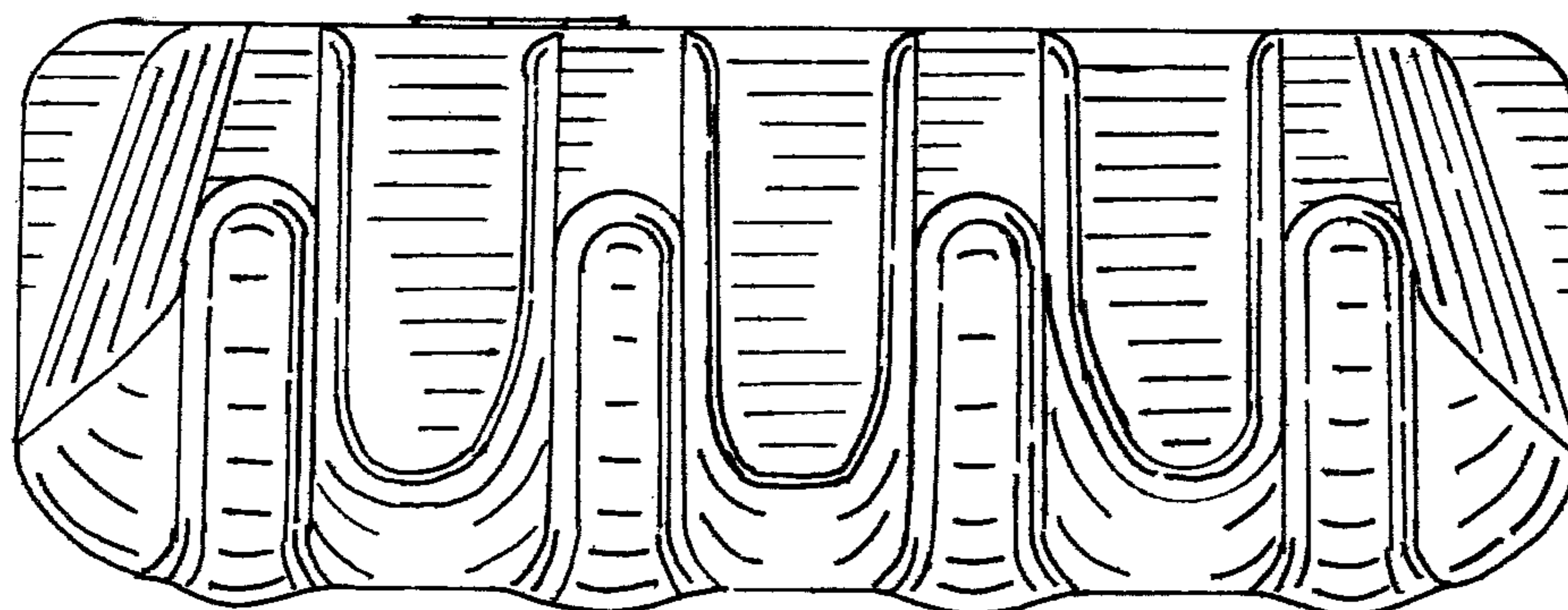

FIG. 20

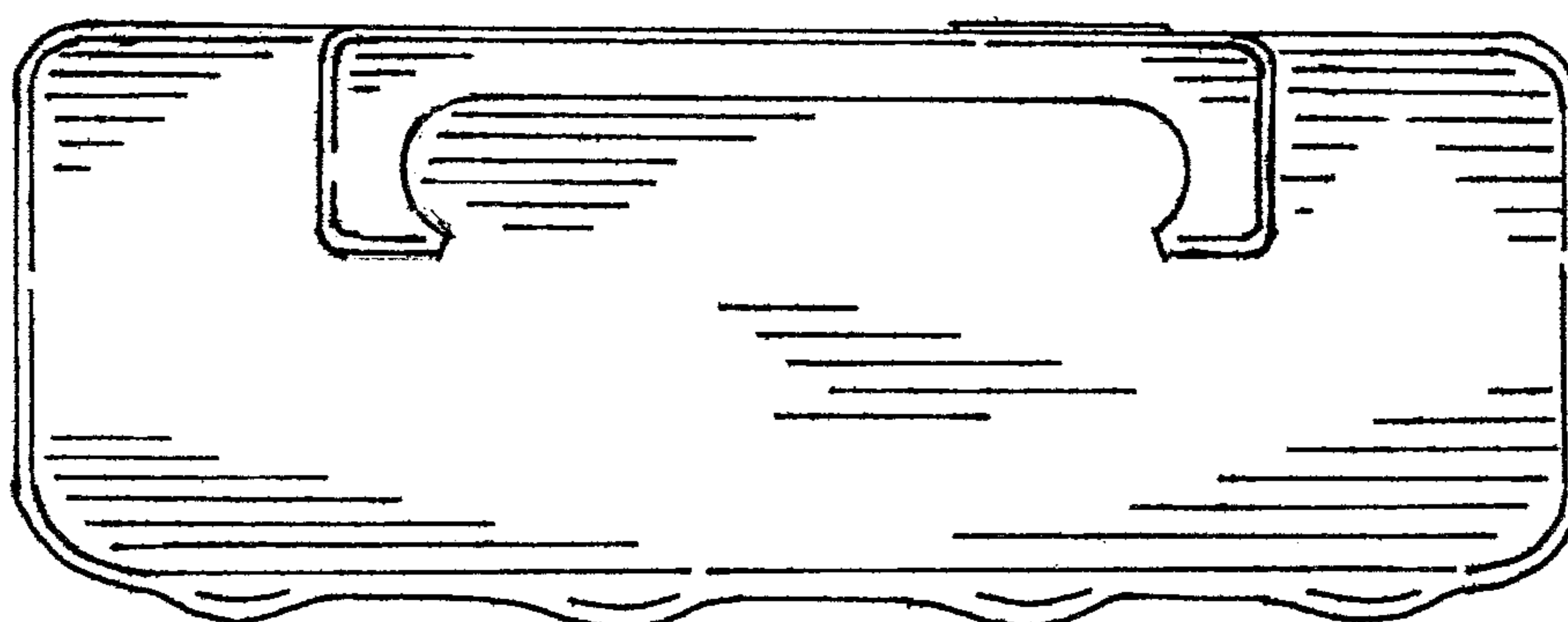

FIG. 21

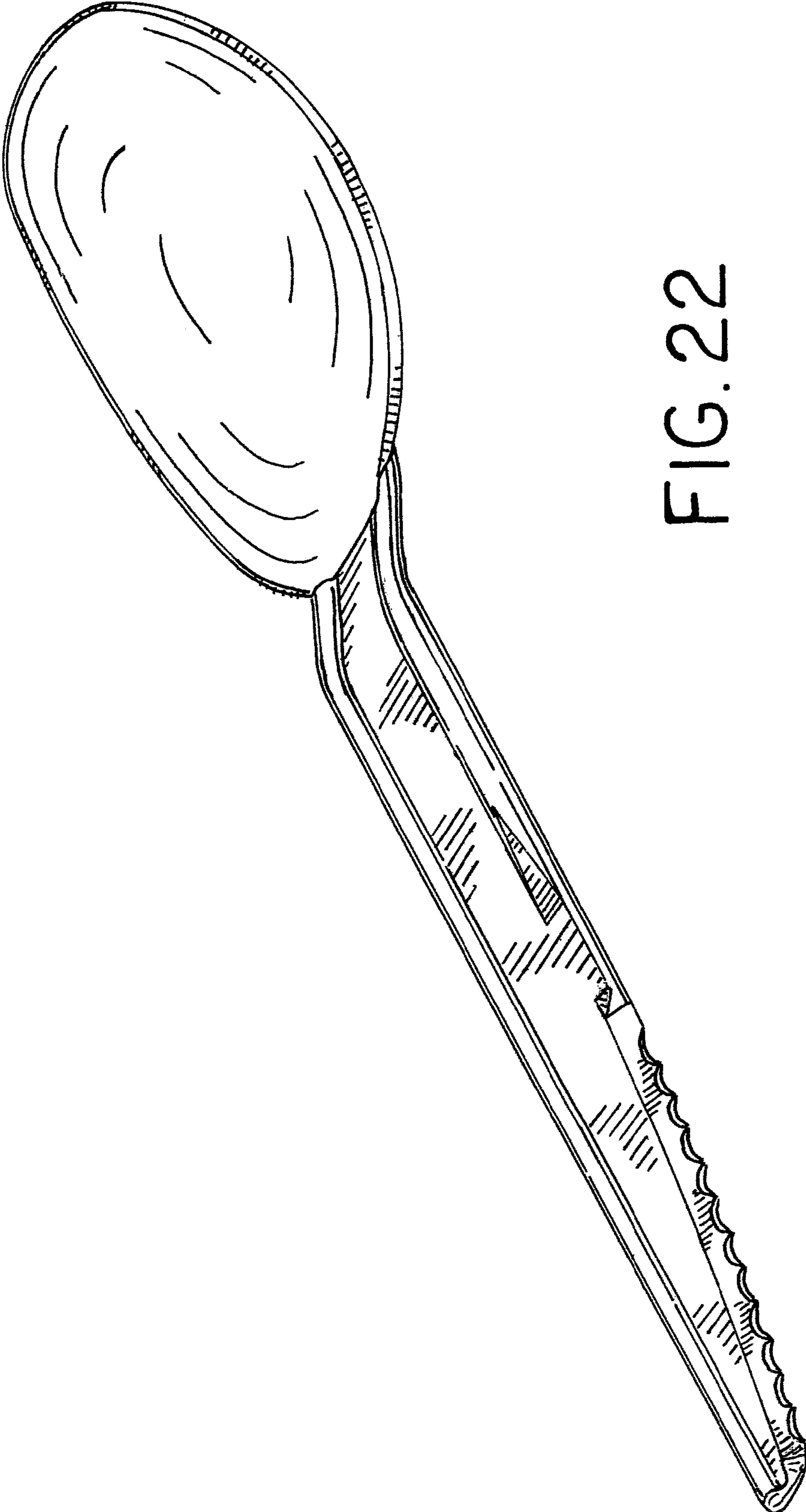

FIG. 22

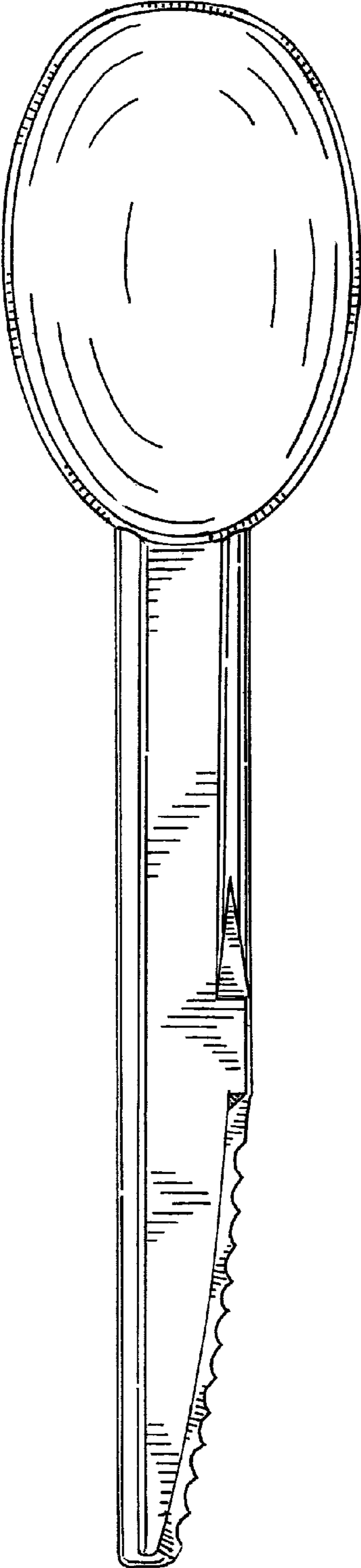

FIG. 23

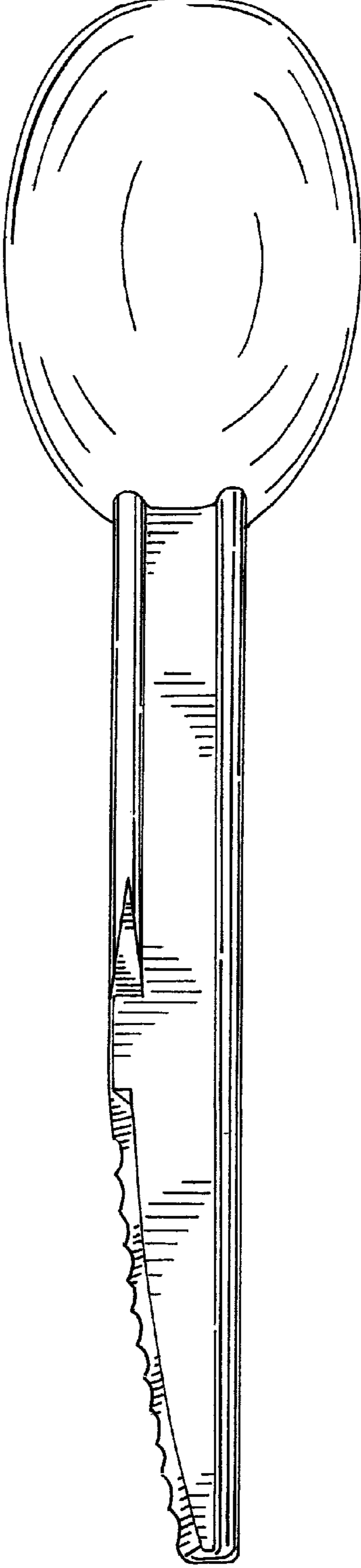

FIG. 24

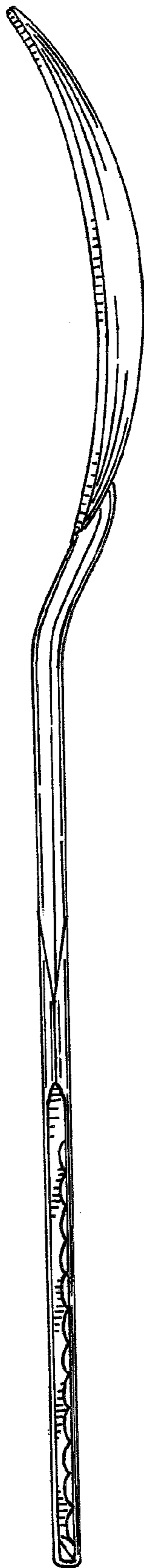

FIG. 25

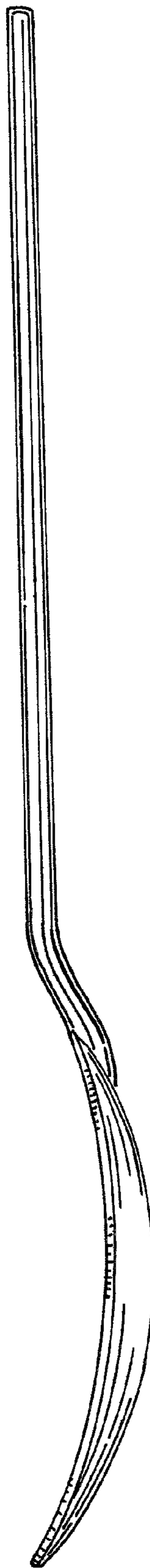

FIG. 26

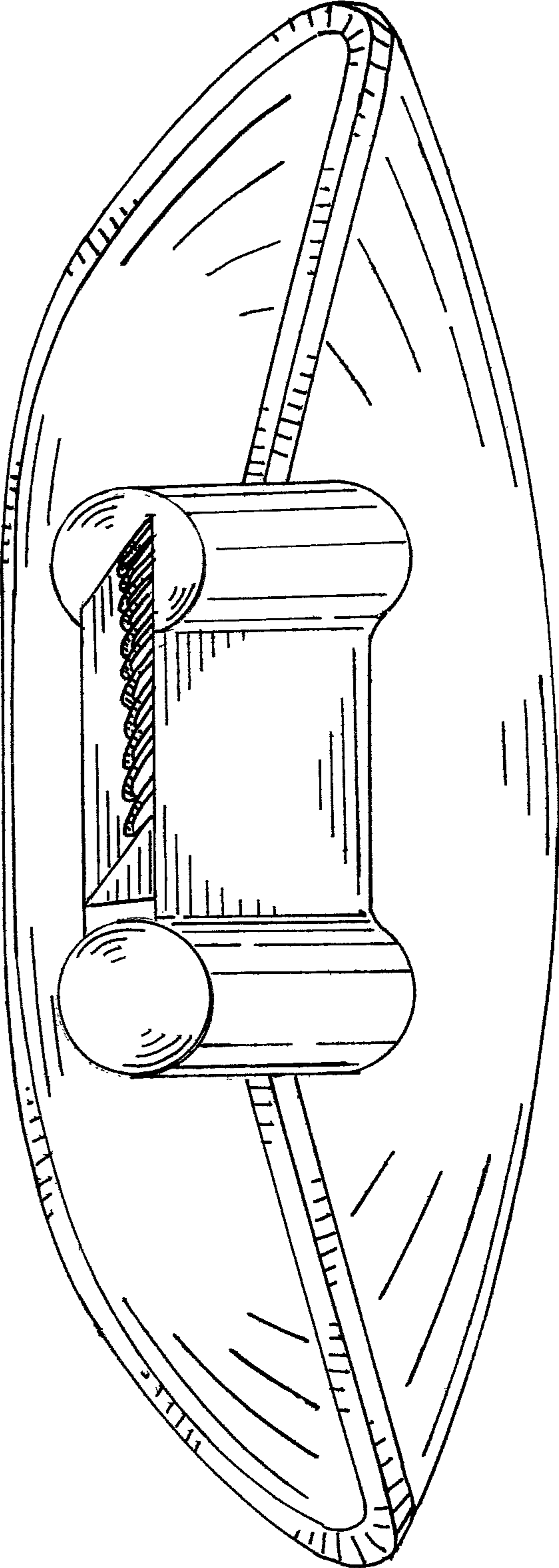

FIG. 27

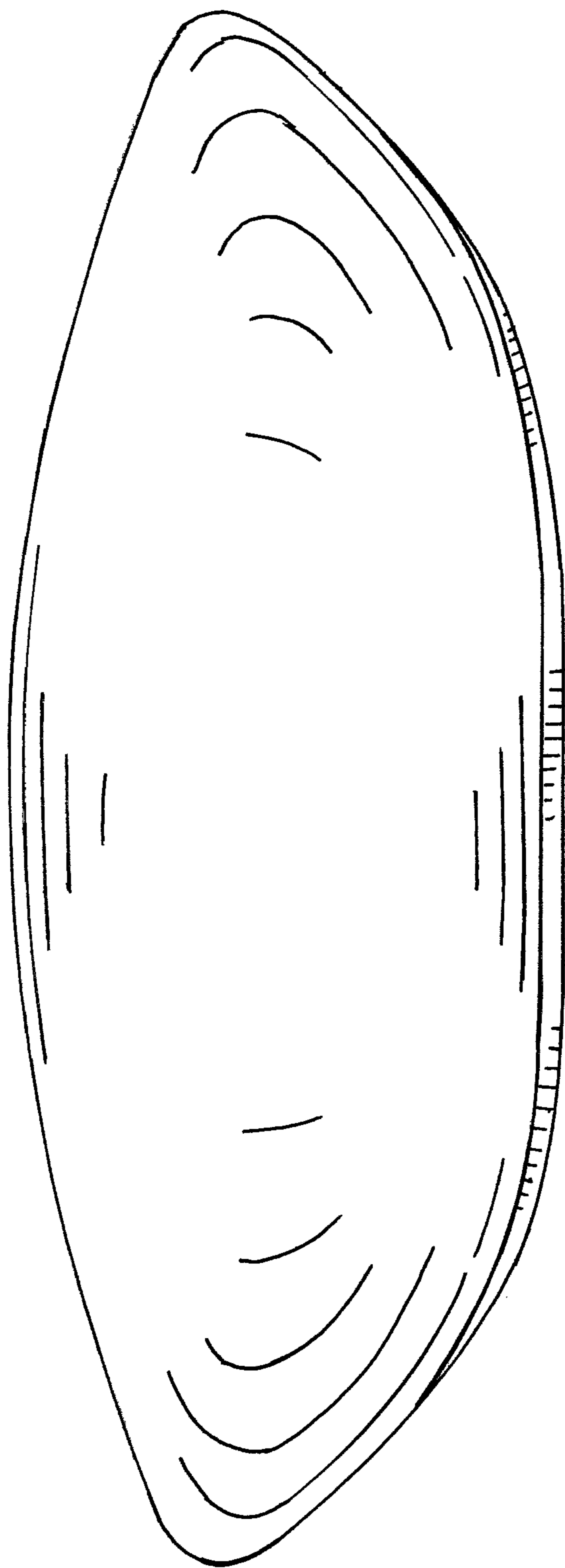

FIG. 28