



US00D753446S

(12) **United States Design Patent**
Hwang

(10) **Patent No.:** **US D753,446 S**
(45) **Date of Patent:** **** Apr. 12, 2016**

(54) **FOOD CONTAINER**

(71) Applicant: **Sam Kwang Glass Co., Ltd**, Seoul (KR)

(72) Inventor: **Do Hwan Hwang**, Seoul (KR)

(73) Assignee: **Sam Kwang Glass Co., Ltd**, Seoul (KR)

(**) Term: **14 Years**

(21) Appl. No.: **29/495,503**

(22) Filed: **Jul. 1, 2014**

(30) **Foreign Application Priority Data**

Feb. 28, 2014 (KR) 30-2014-0010144

(51) **LOC (10) Cl.** **07-07**

(52) **U.S. Cl.**
USPC **D7/629**

(58) **Field of Classification Search**
USPC D7/602, 629, 630, 538–542;
D9/424–432
CPC B65D 21/0219; B65D 2543/00296;
B65D 21/02; B65D 21/004; B65D 2543/0537;
B65D 2543/00092; B65D 2543/00685; B65D
2543/00796; B65D 51/00

See application file for complete search history.

(56) **References Cited**

U.S. PATENT DOCUMENTS

5,377,860 A * 1/1995 Littlejohn B65D 21/0219
220/4.21
D741,704 S * 10/2015 Bouveret D9/425

* cited by examiner

Primary Examiner — Terry Wallace

(74) *Attorney, Agent, or Firm* — Honigman Miller Schwartz
and Cohn LLP

(57) **CLAIM**

The ornamental design for a food container, as shown and
described.

DESCRIPTION

FIG. 1 is a perspective view of a food container showing my
new design;

FIG. 2 is a front view of the food container of FIG. 1;

FIG. 3 is a back view of the food container of FIG. 1;

FIG. 4 is a right view of the food container of FIG. 1;

FIG. 5 is a left view of the food container of FIG. 1;

FIG. 6 is a top view of the food container of FIG. 1;

FIG. 7 is a bottom view of the food container of FIG. 1;

FIG. 8 is a perspective view of an alternate embodiment of
FIG. 1;

FIG. 9 is a front view of the food container of FIG. 8;

FIG. 10 is a back view of the food container of FIG. 8;

FIG. 11 is a right view of the food container of FIG. 8;

FIG. 12 is a left view of the food container of FIG. 8;

FIG. 13 is a top view of the food container of FIG. 8; and,

FIG. 14 is a bottom view of the food container of FIG. 8.

The broken lines are for illustrative purposes and form no part
of the present invention.

1 Claim, 8 Drawing Sheets

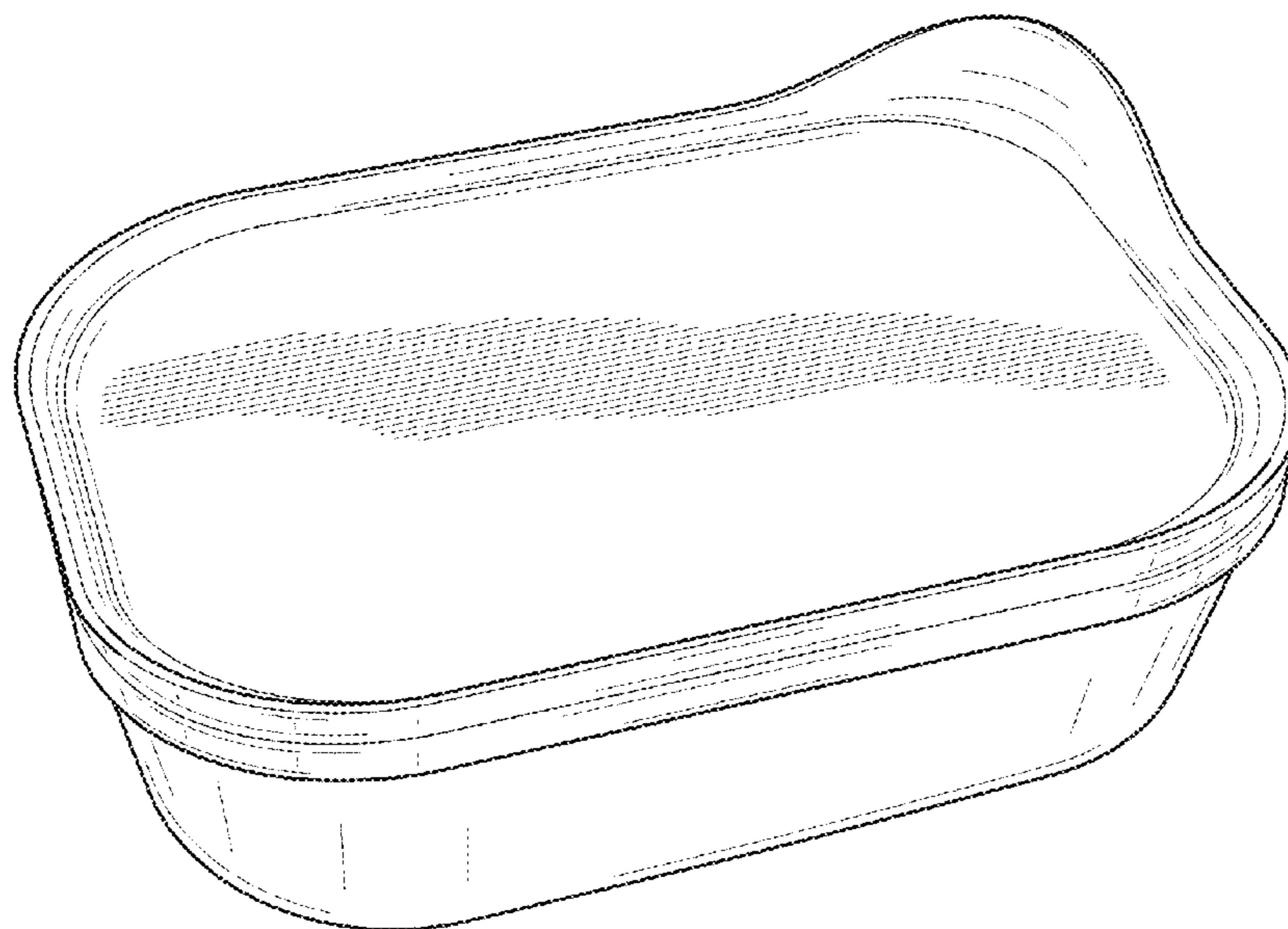

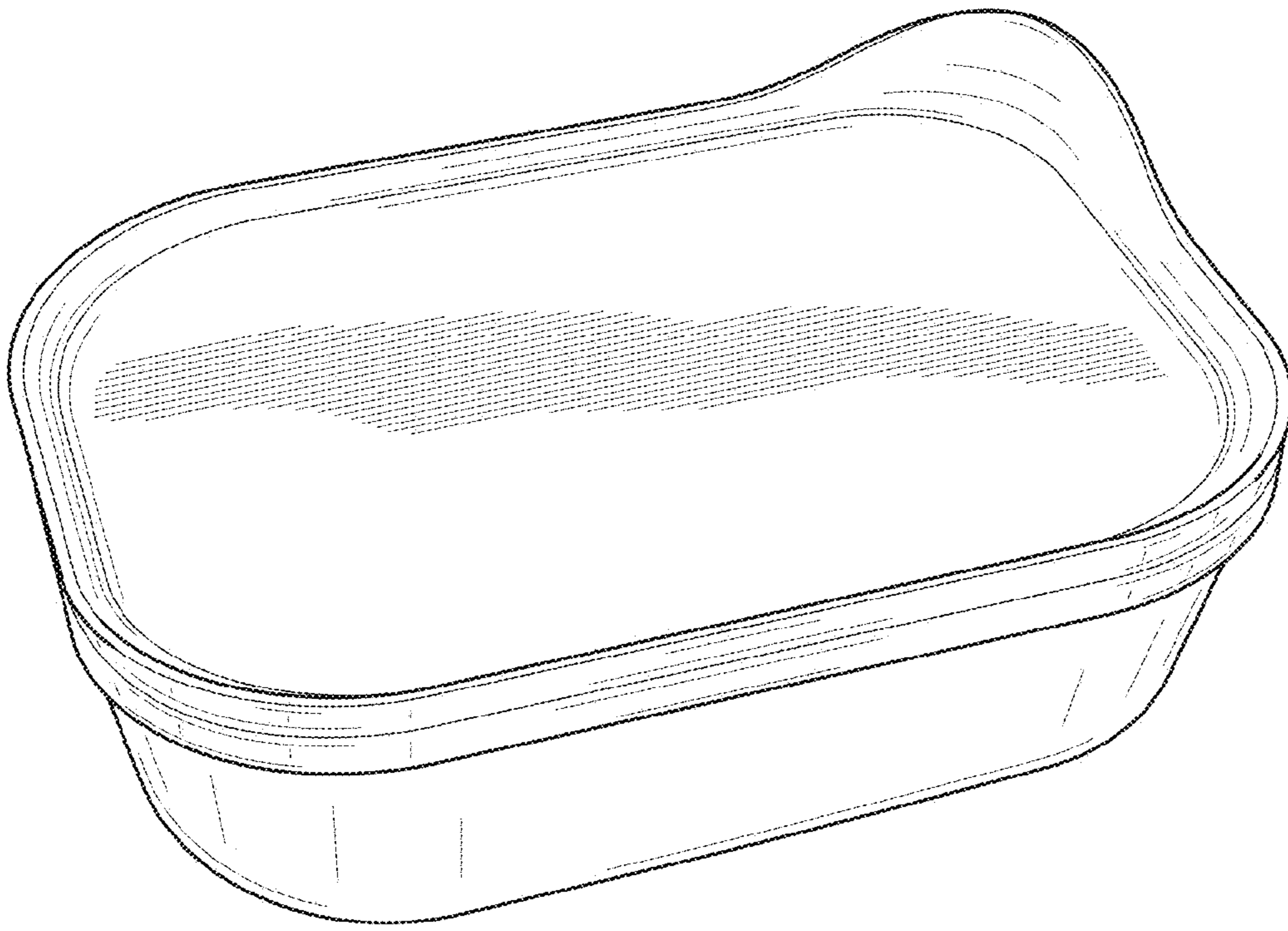

FIG. 1

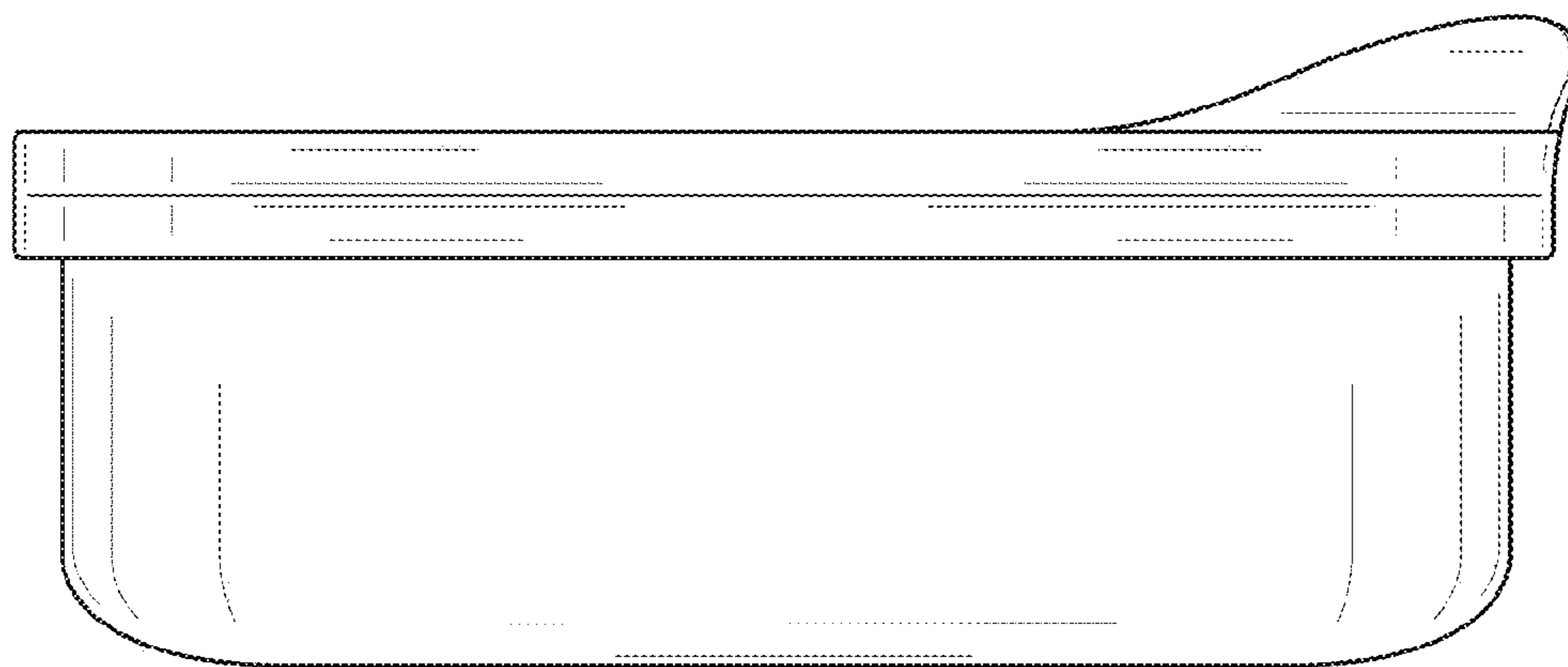

FIG. 2

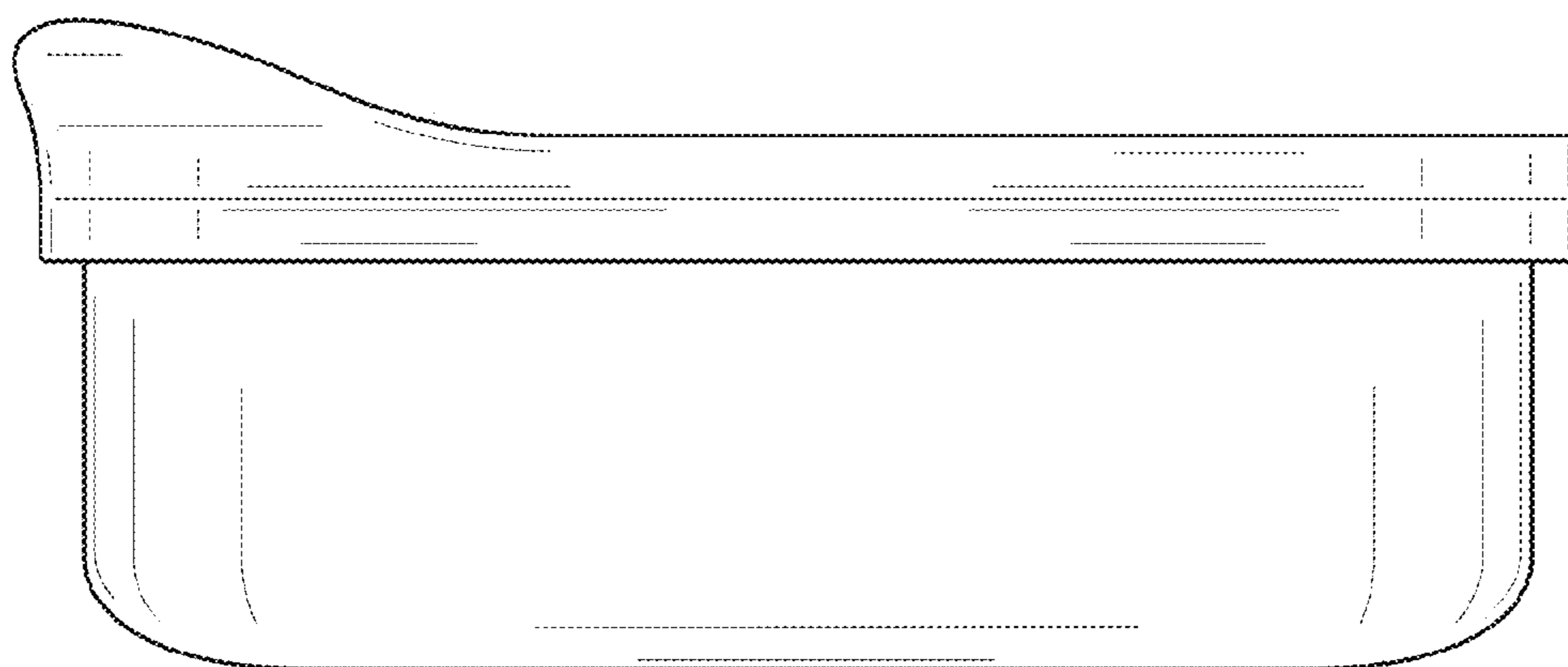

FIG. 3

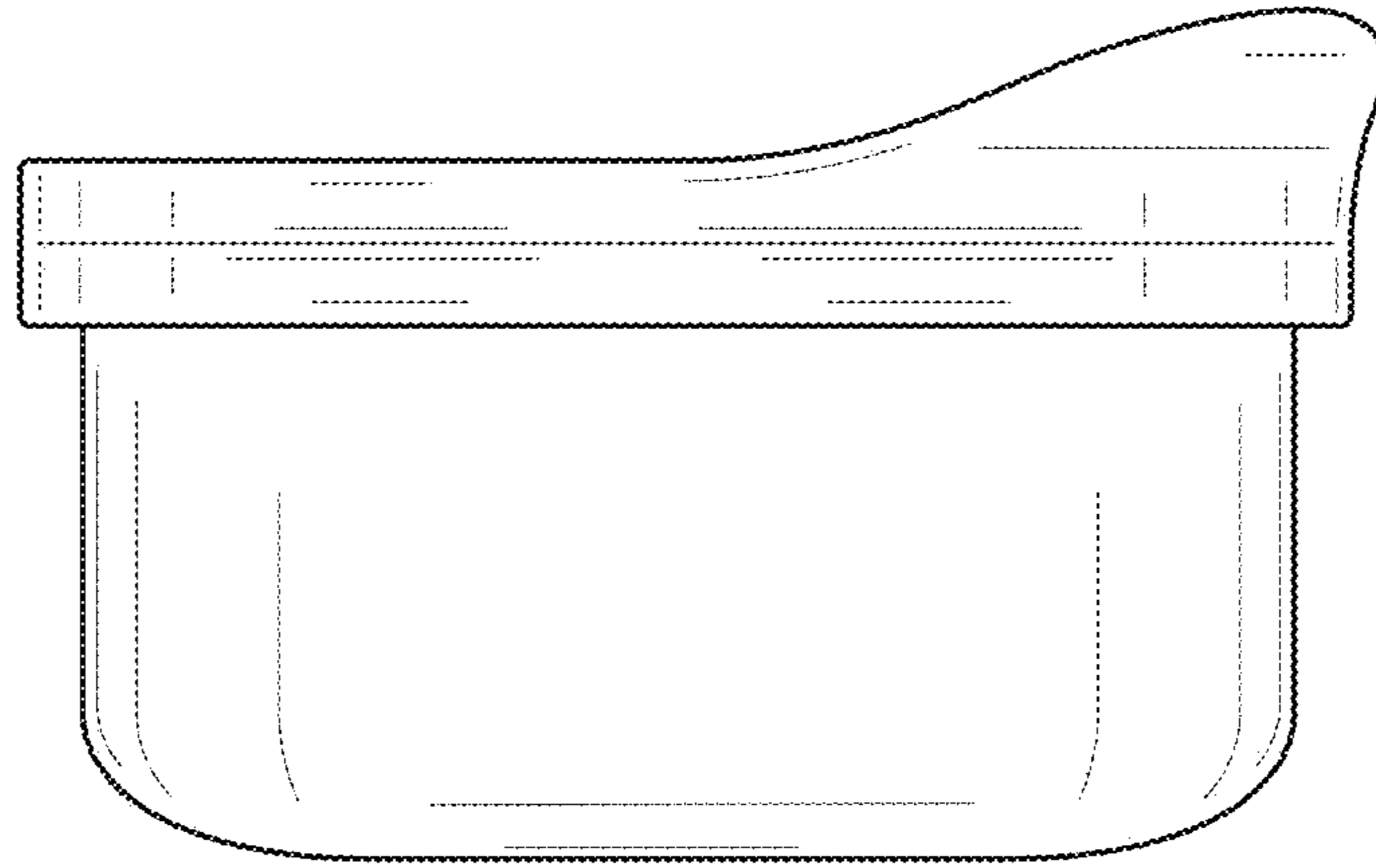

FIG. 4

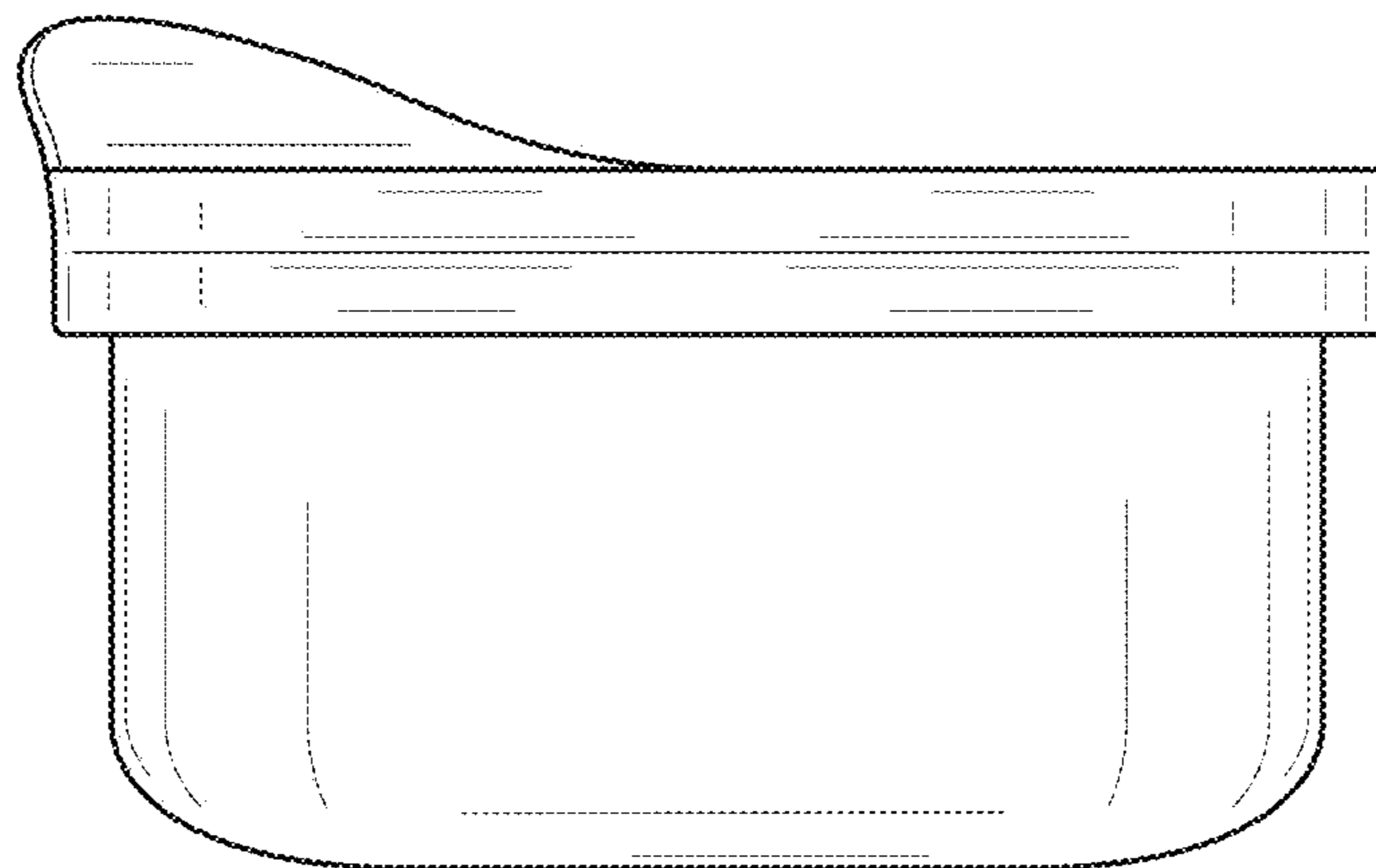

FIG. 5

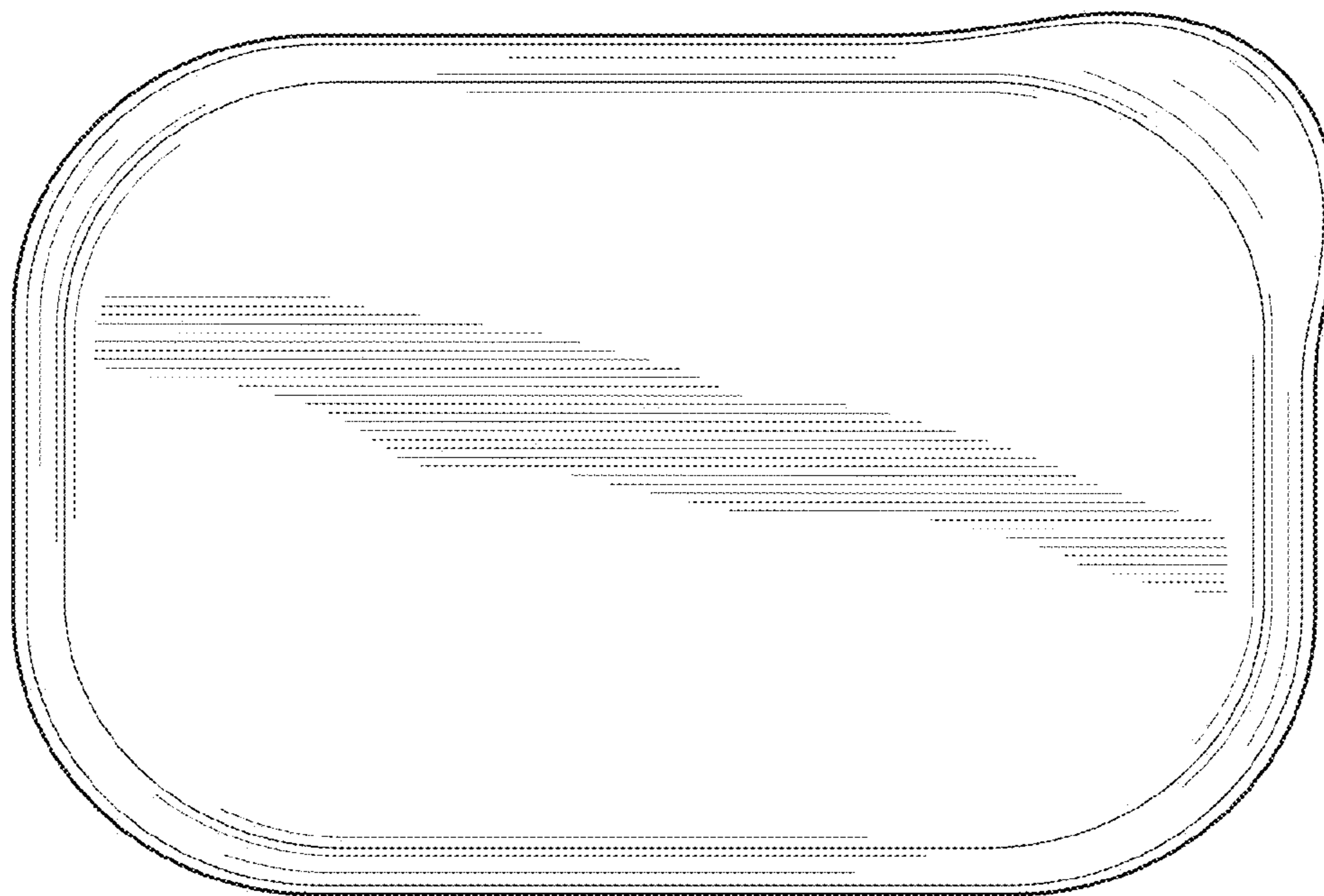

FIG. 6

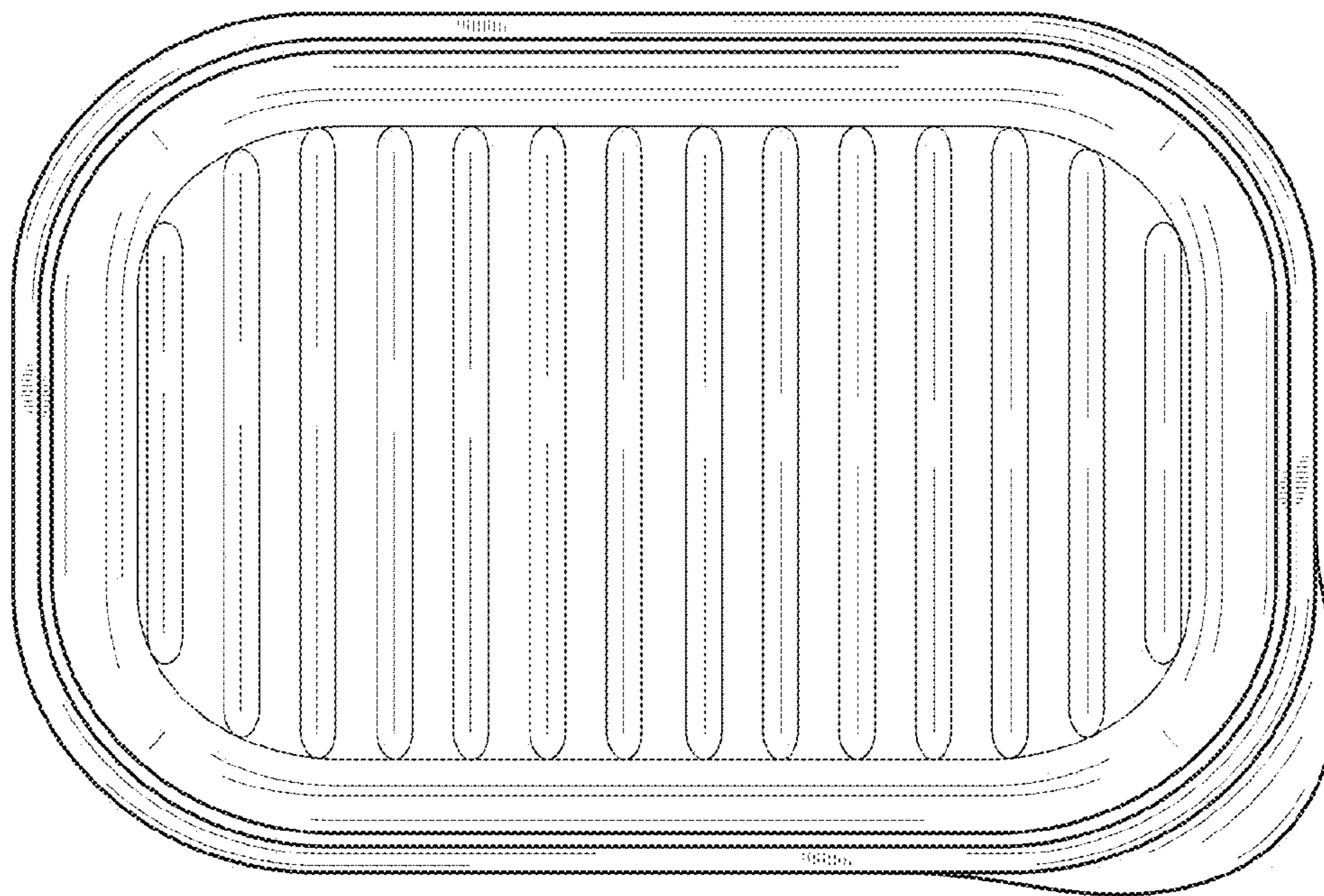

FIG. 7

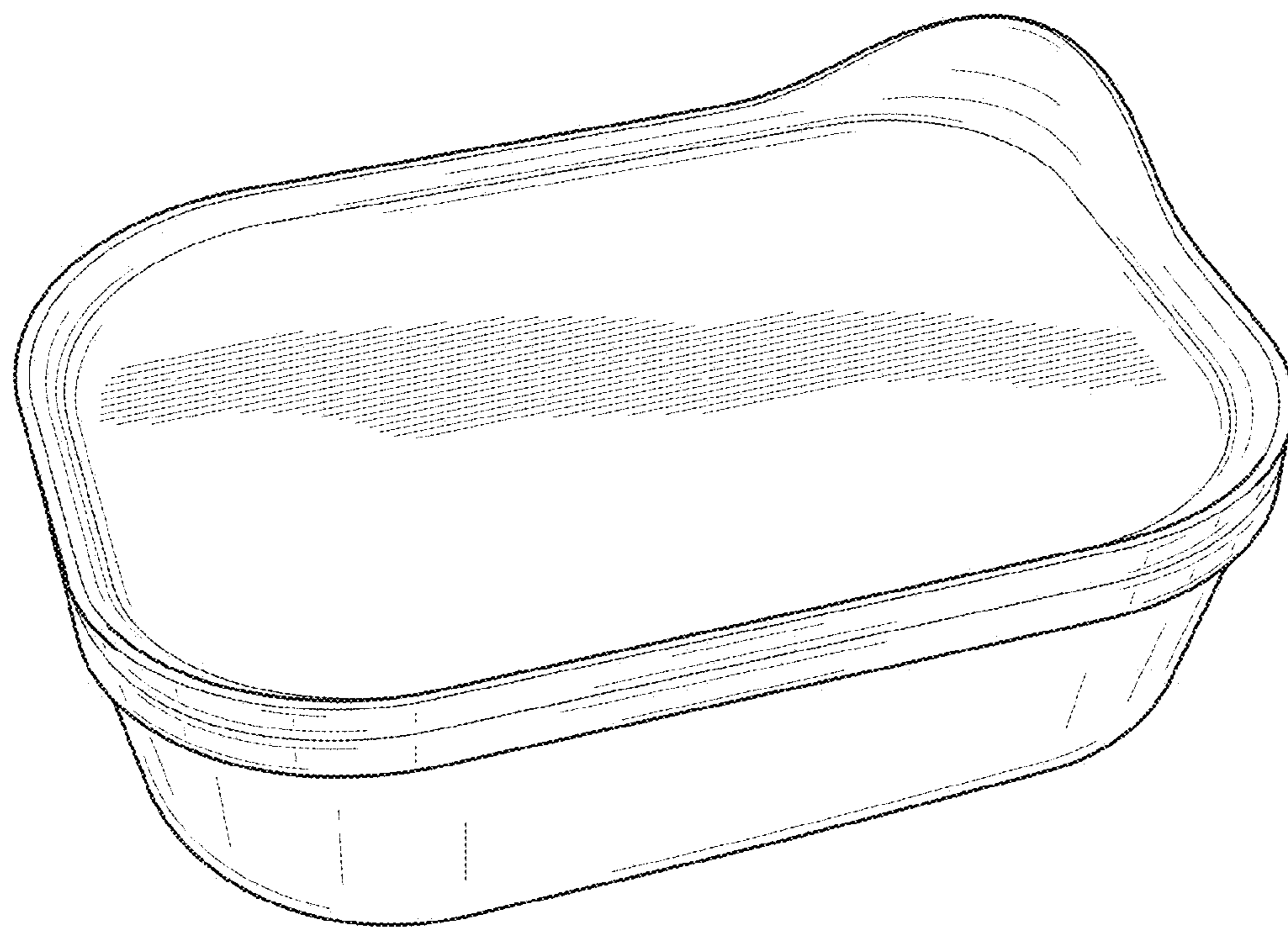

FIG. 8

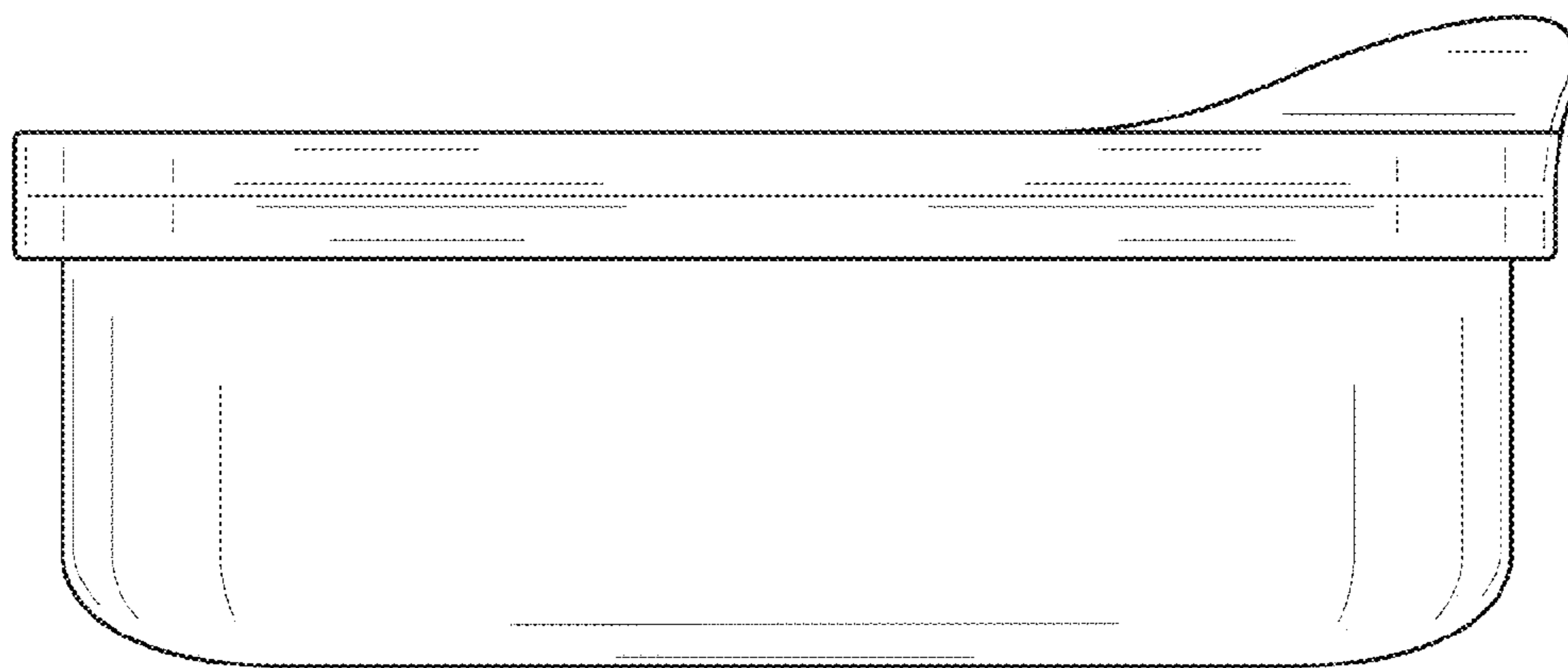

FIG. 9

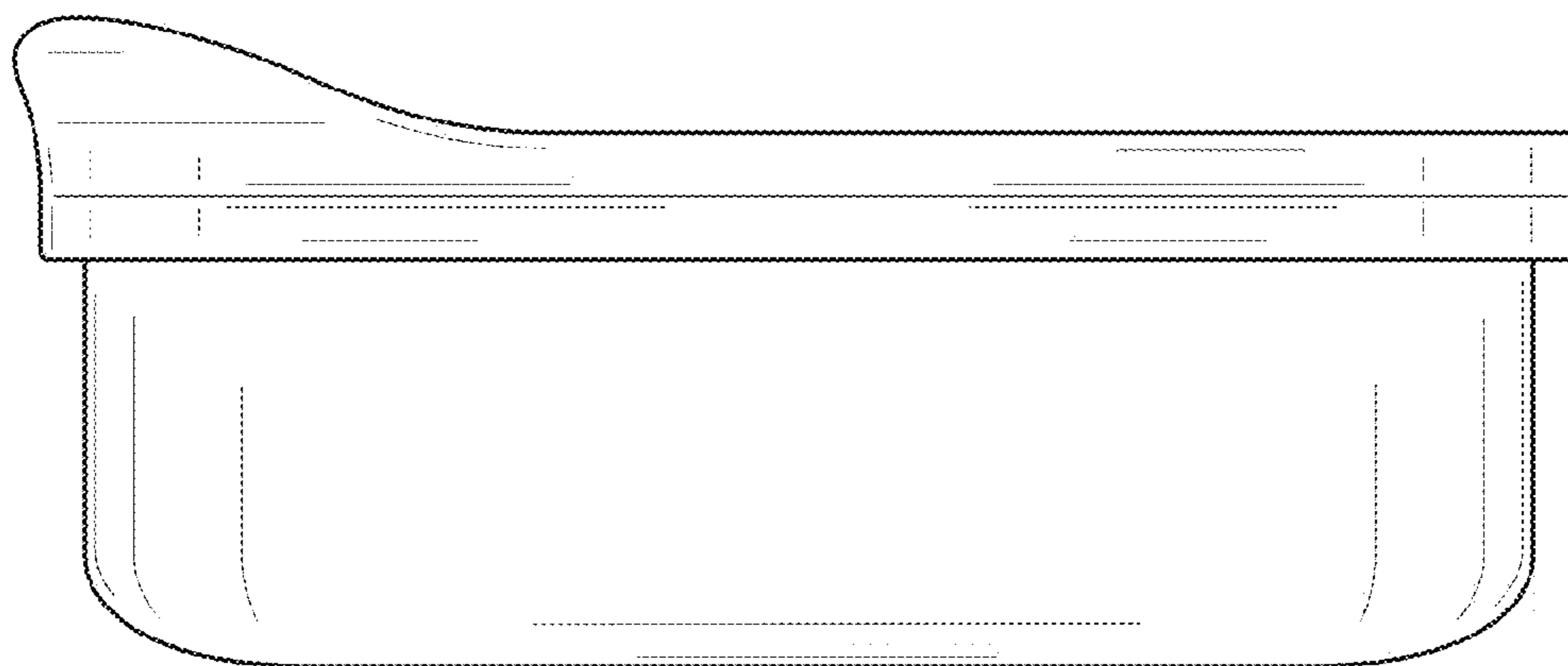

FIG. 10

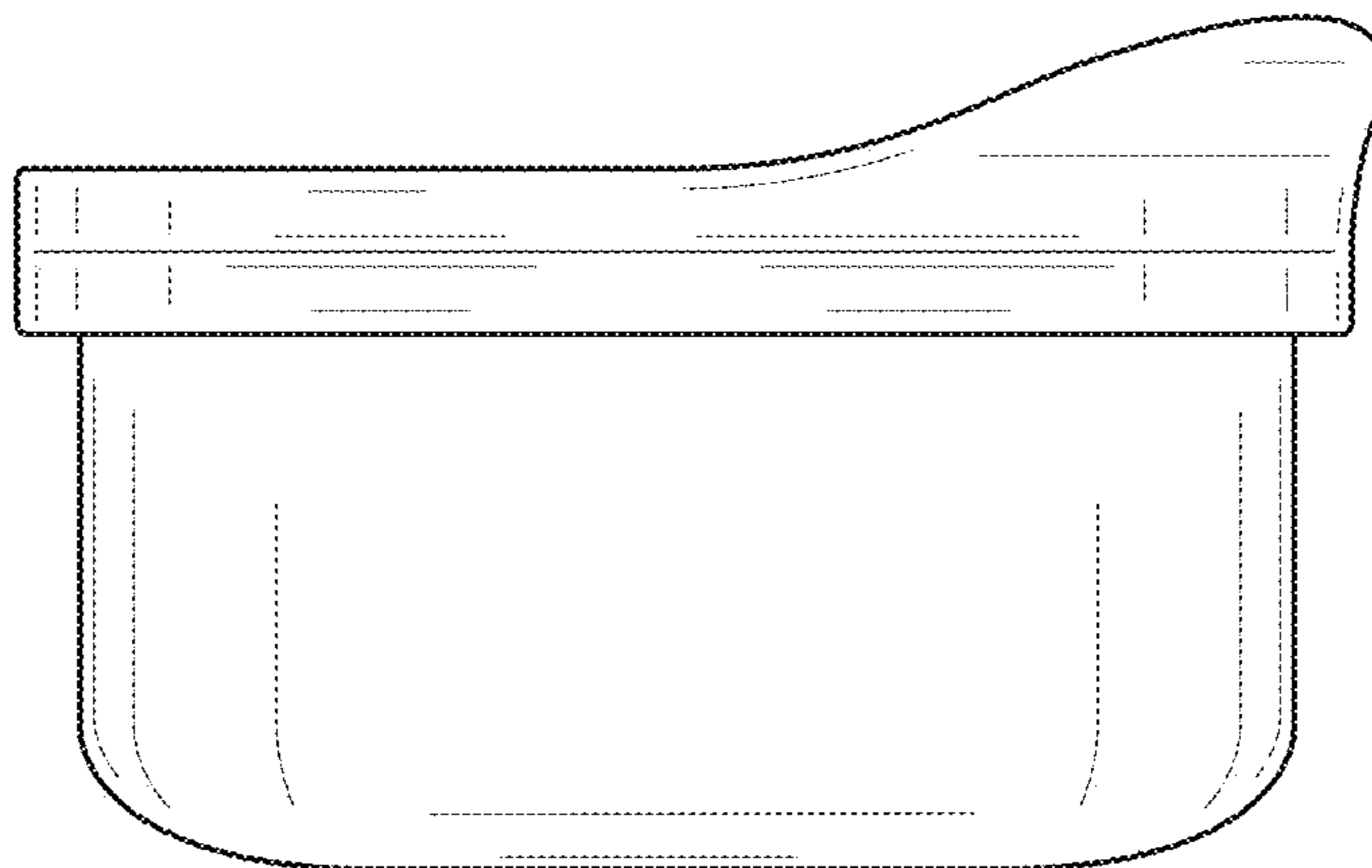

FIG. 11

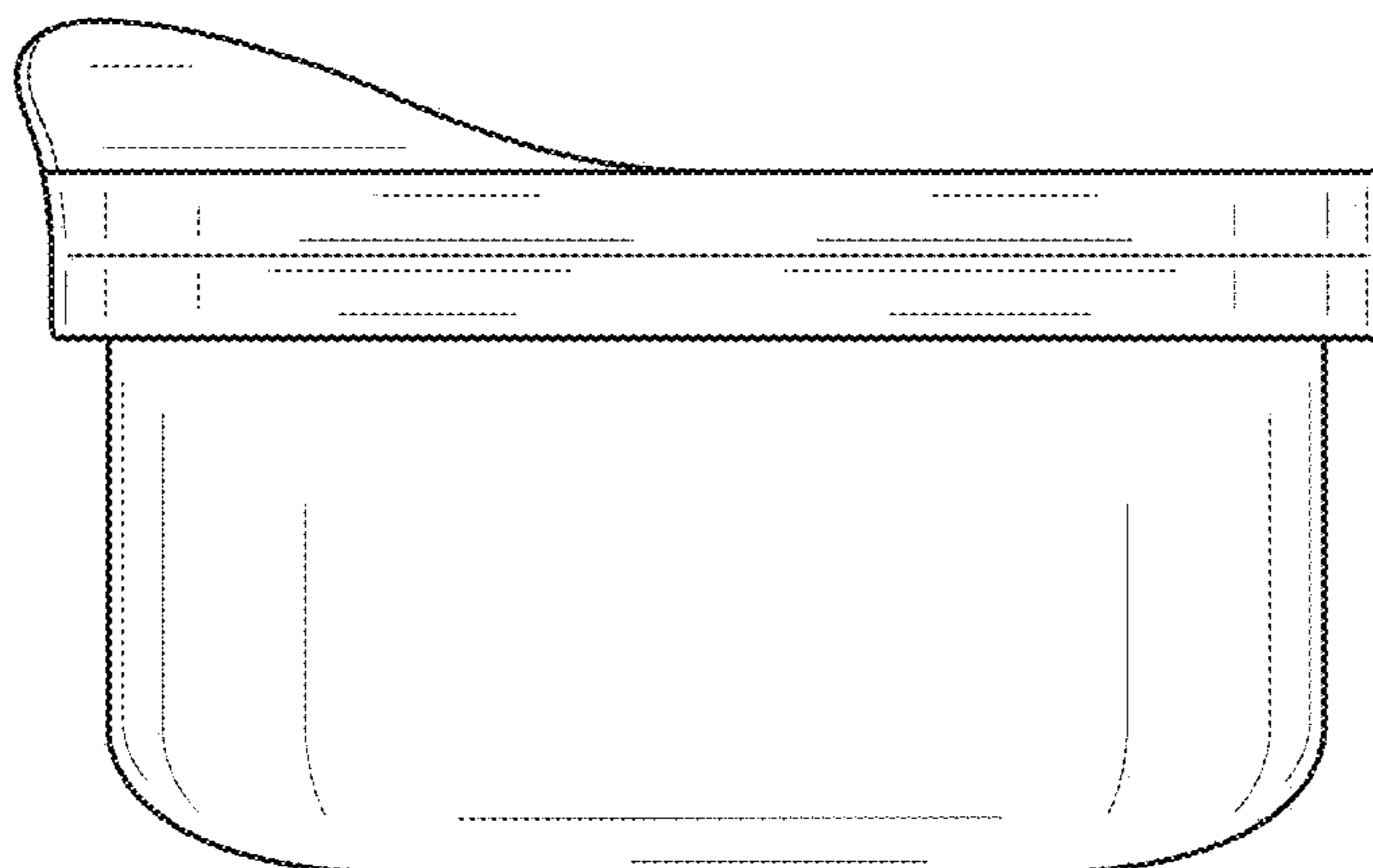

FIG. 12

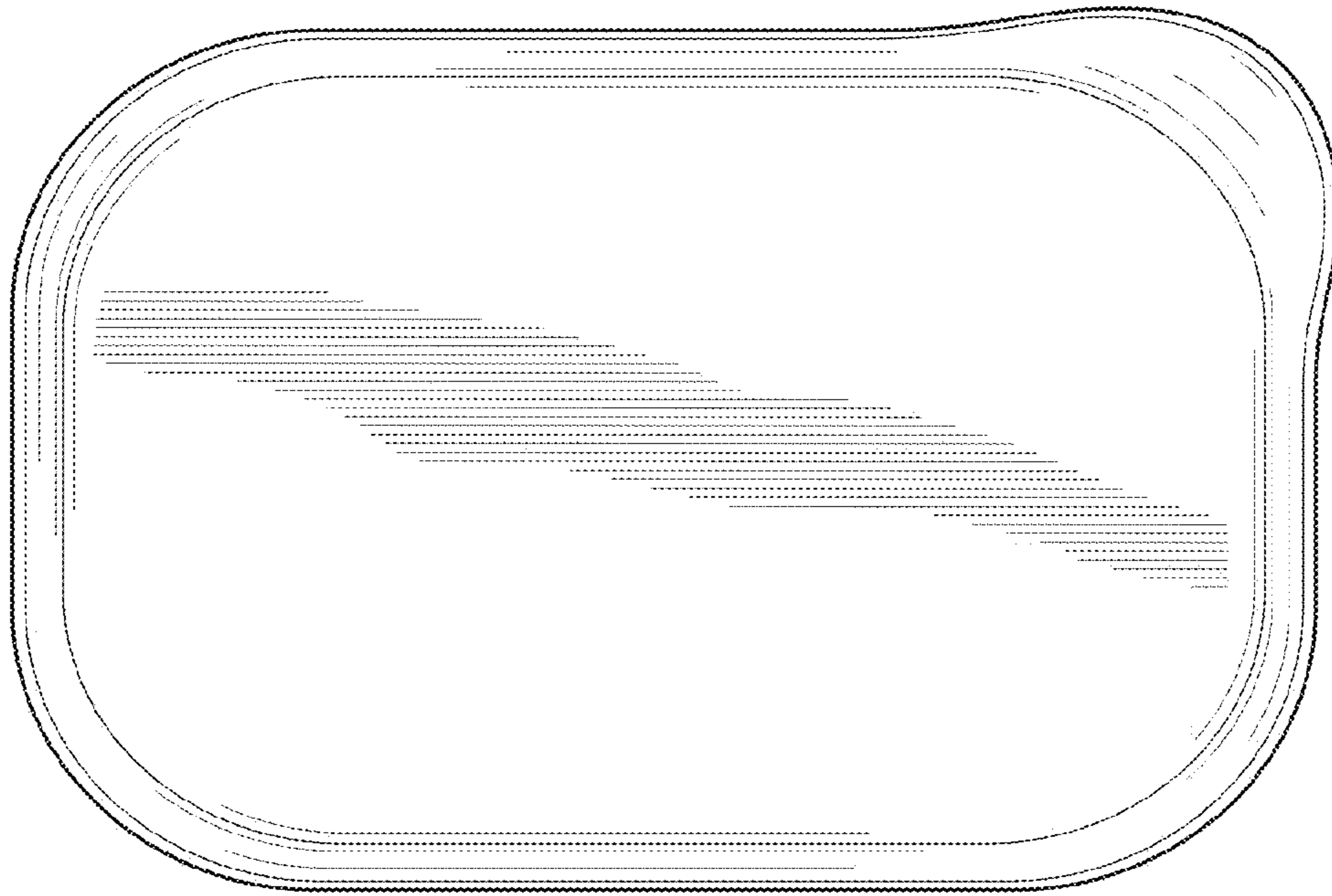

FIG. 13

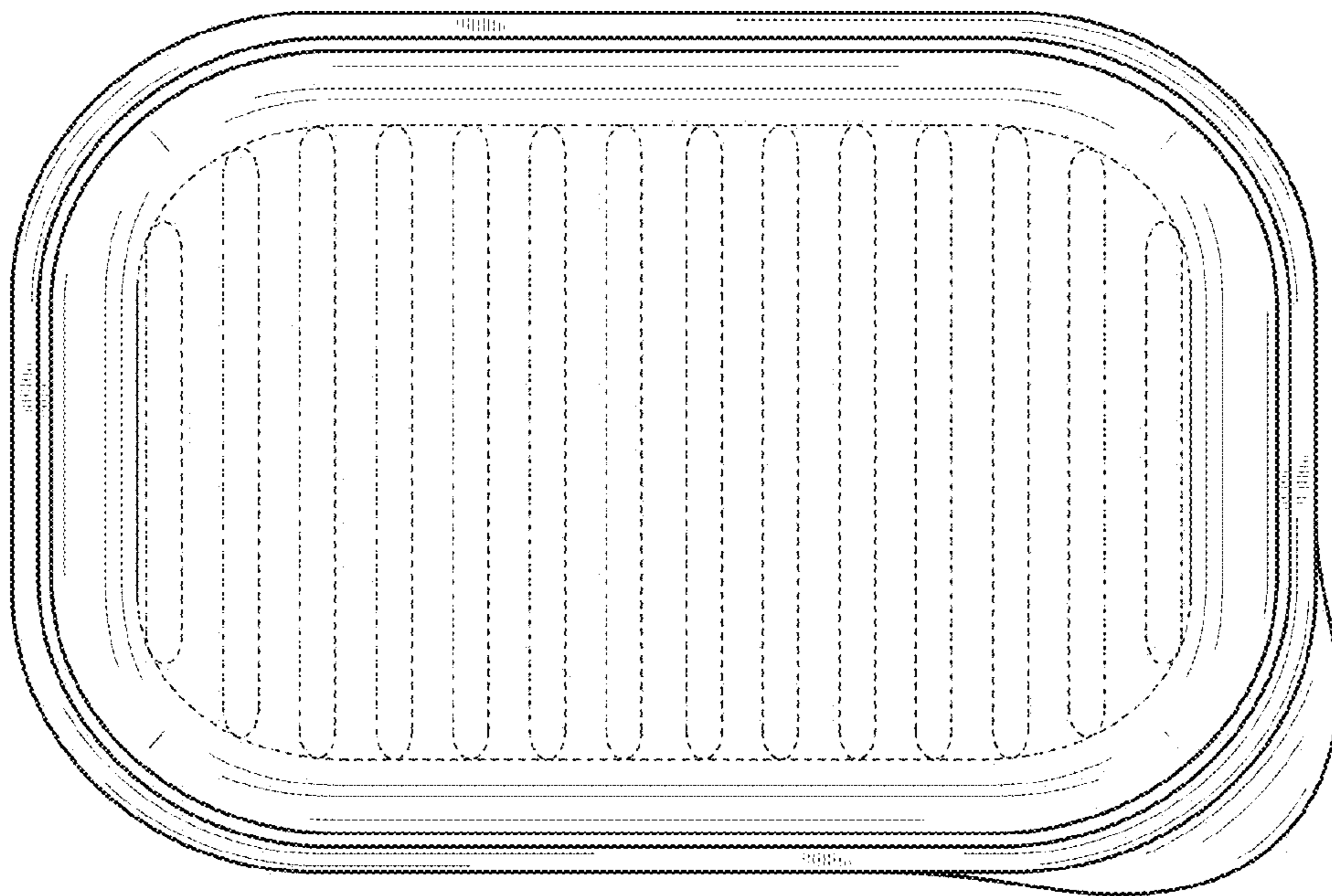

FIG. 14