



US00D753389S

(12) **United States Design Patent**
Marziari

(10) **Patent No.:** **US D753,389 S**
(45) **Date of Patent:** **** Apr. 12, 2016**

(54) **HANDBAG**

(71) Applicant: **Salvatore Ferragamo S.p.A.**, Florence (IT)

(72) Inventor: **Ester Marziari**, Montevarchi (IT)

(73) Assignee: **Salvatore Ferragamo, S.p.A.**, Florence (IT)

(**) Term: **14 Years**

(21) Appl. No.: **29/502,315**

(22) Filed: **Sep. 15, 2014**

(30) **Foreign Application Priority Data**

Mar. 18, 2014 (IT) FI2014O0014

(51) **LOC (10) Cl.** **03-01**

(52) **U.S. Cl.**
USPC **D3/245**

(58) **Field of Classification Search**
USPC D3/245
CPC A45C 1/024; A45C 3/08
See application file for complete search history.

(56) **References Cited**

U.S. PATENT DOCUMENTS

D632,480 S * 2/2011 LaCorte D3/232
D719,349 S * 12/2014 Fusi D3/245

* cited by examiner

Primary Examiner — Holly Baynham

(74) *Attorney, Agent, or Firm* — Kelley Drye & Warren LLP

(57) **CLAIM**

The ornamental design for a handbag, as shown.

DESCRIPTION

FIG. 1 is a perspective view of a handbag showing my new design;
FIG. 2 is a front elevational view thereof;
FIG. 3 is a rear elevational view thereof;
FIG. 4 is a right side elevational view thereof;
FIG. 5 is a left side elevational view thereof;
FIG. 6 is a bottom plan view thereof; and,
FIG. 7 is a top plan view thereof.

1 Claim, 6 Drawing Sheets

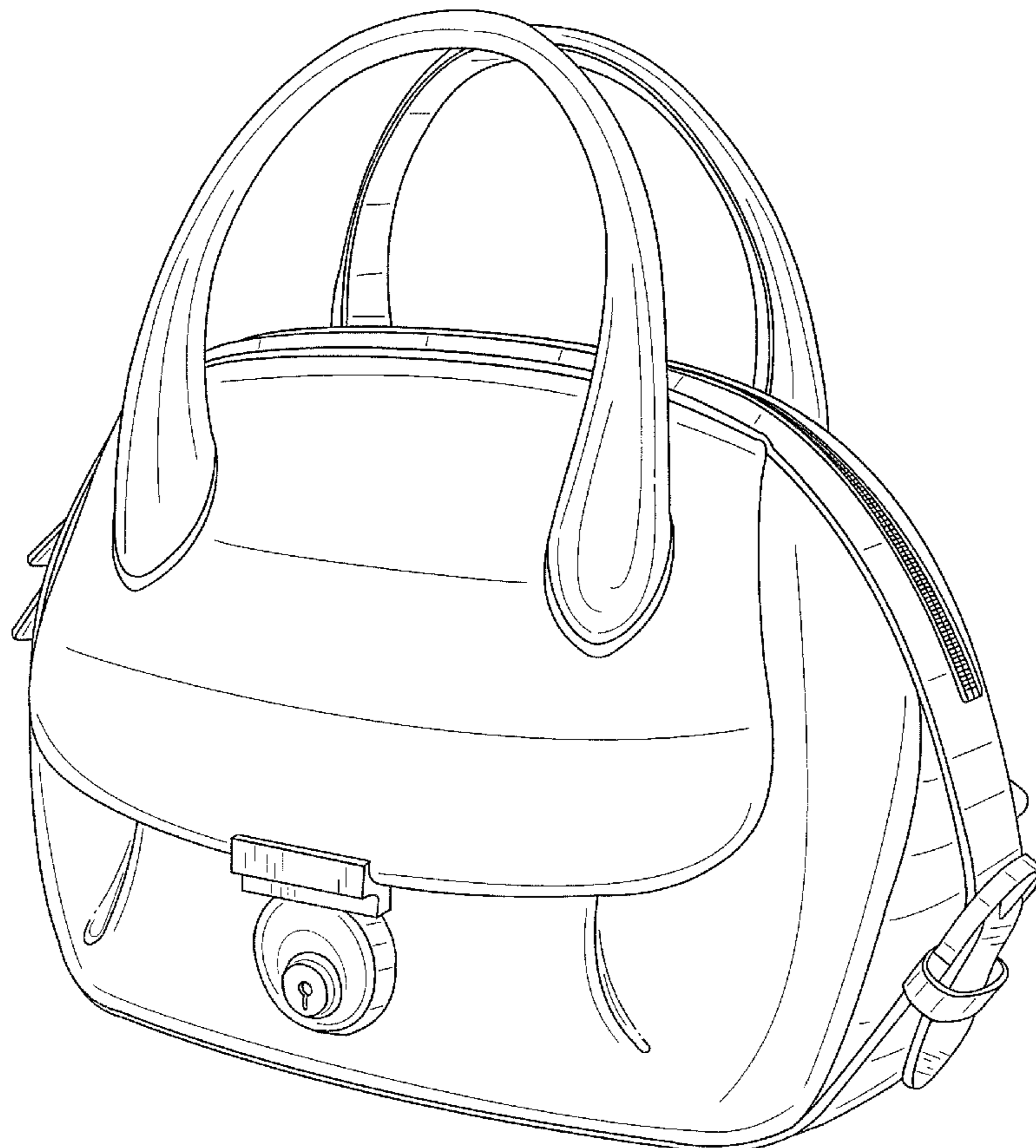

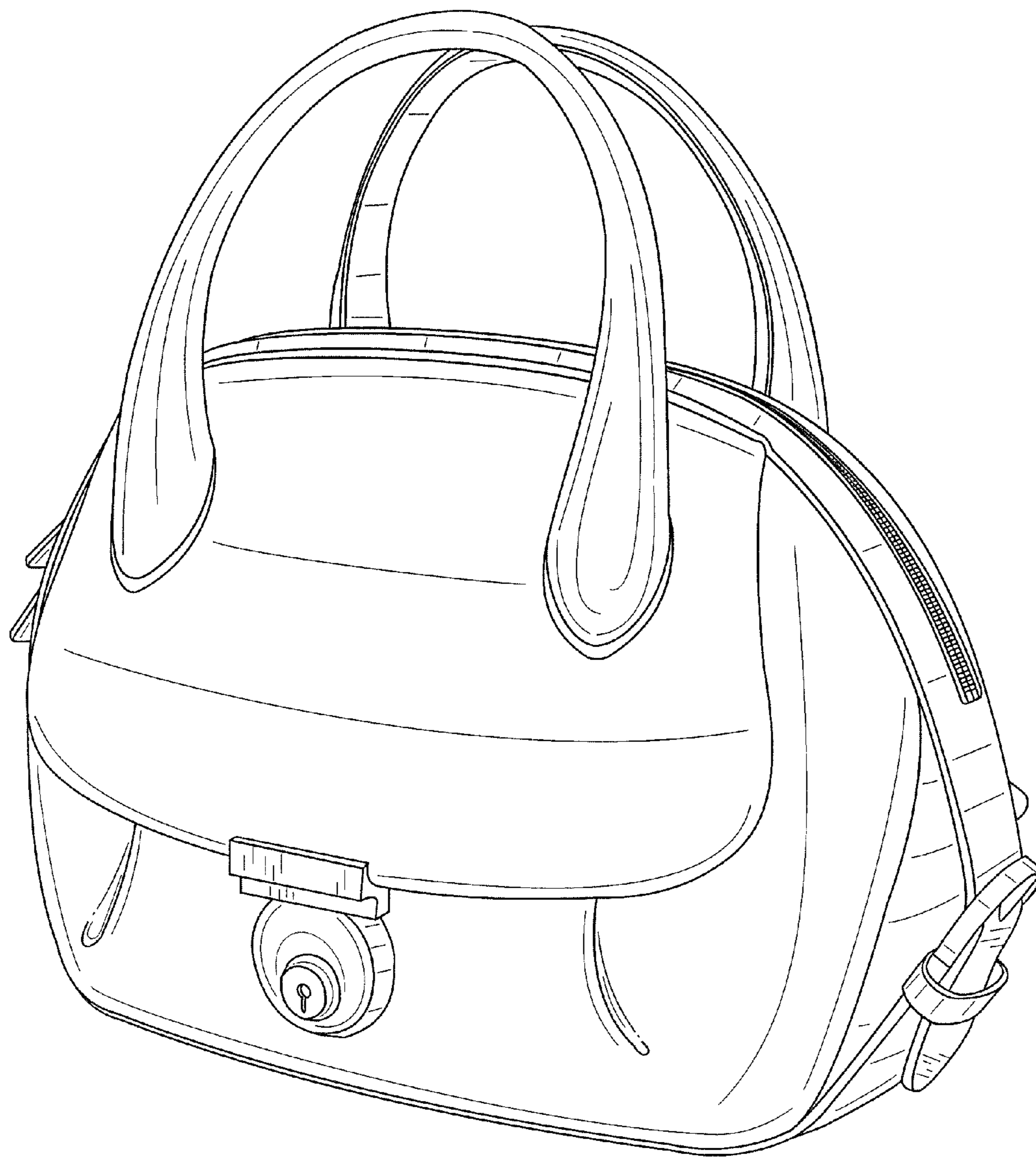

FIG. 1

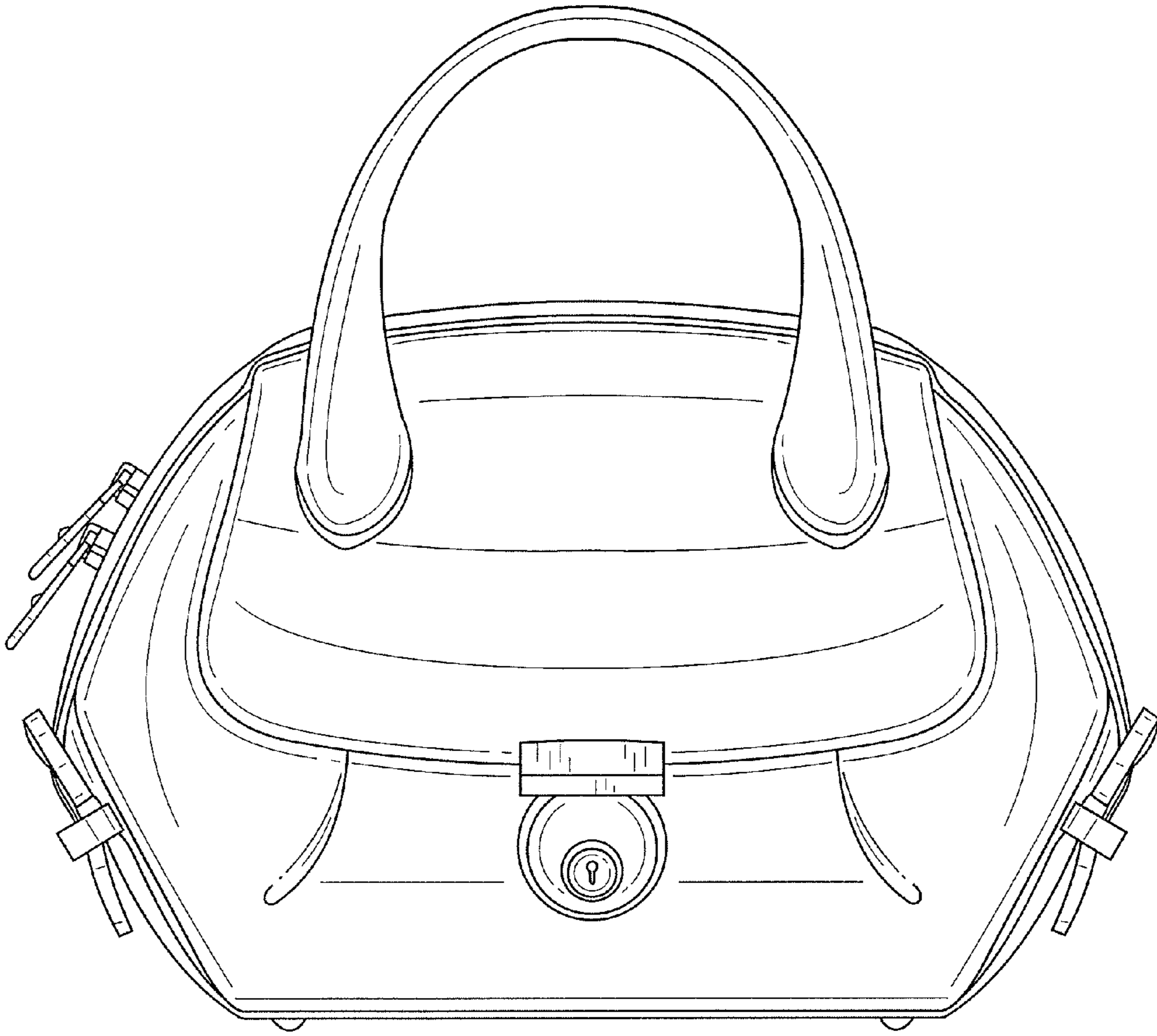

FIG. 2

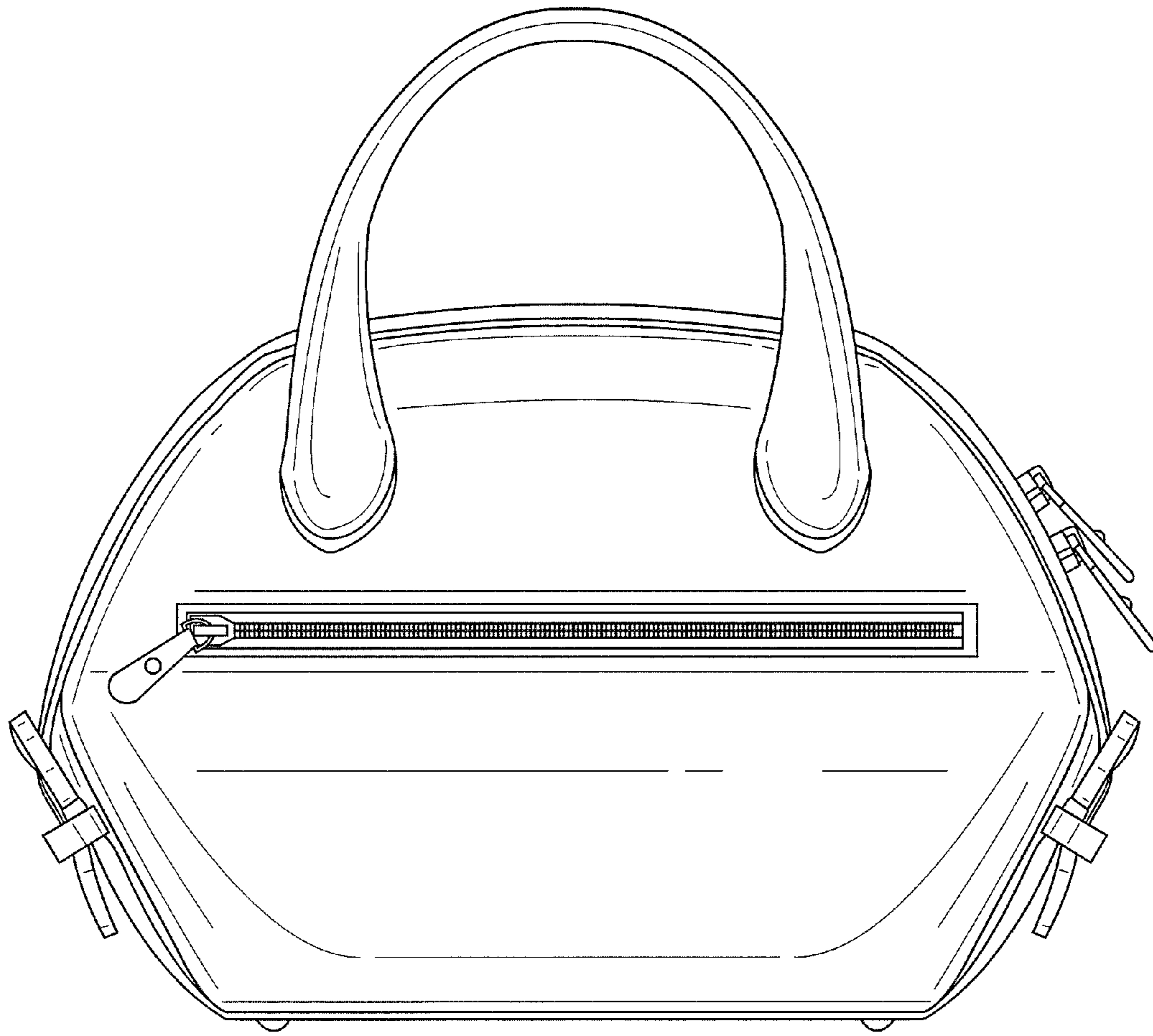

FIG. 3

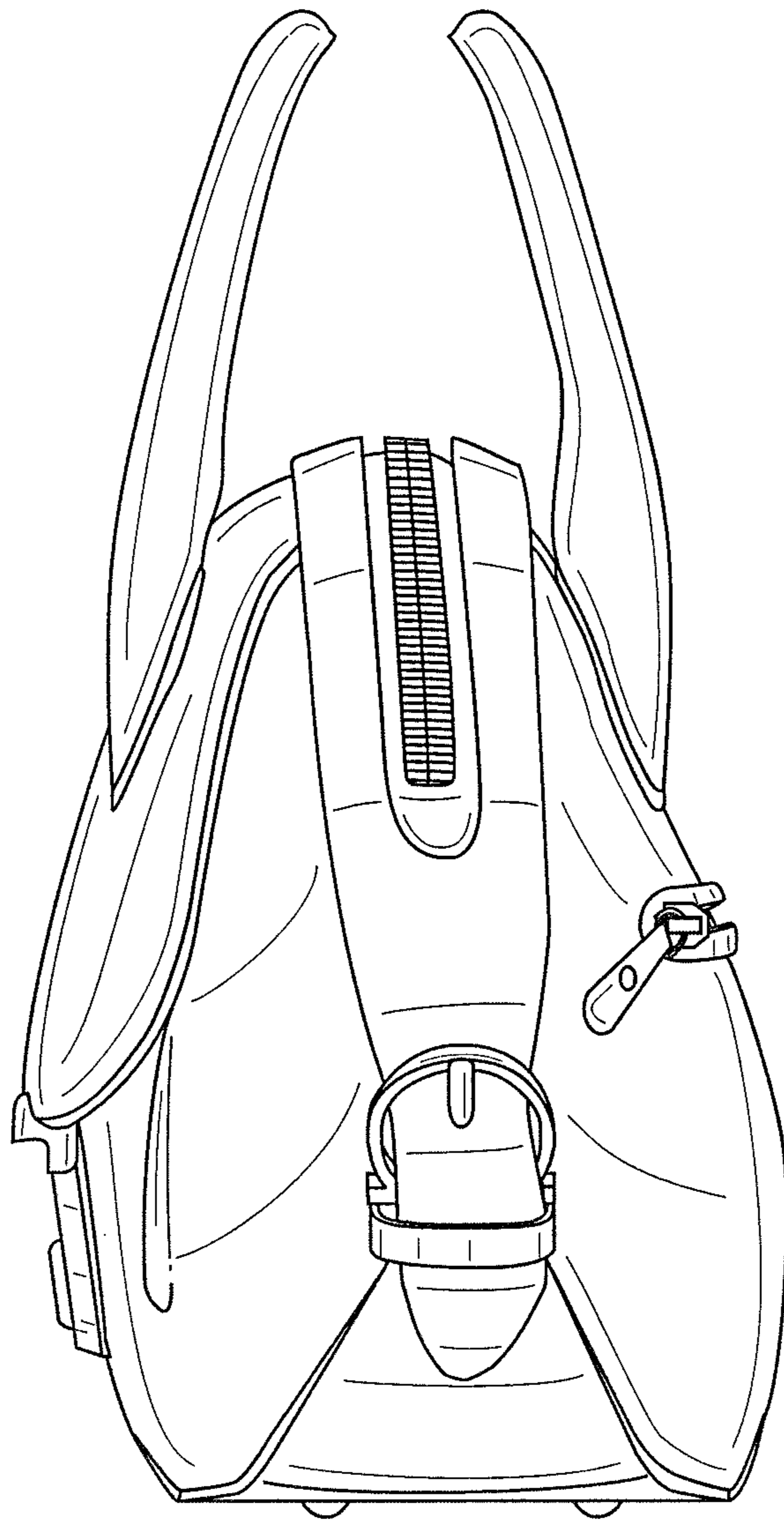

FIG. 4

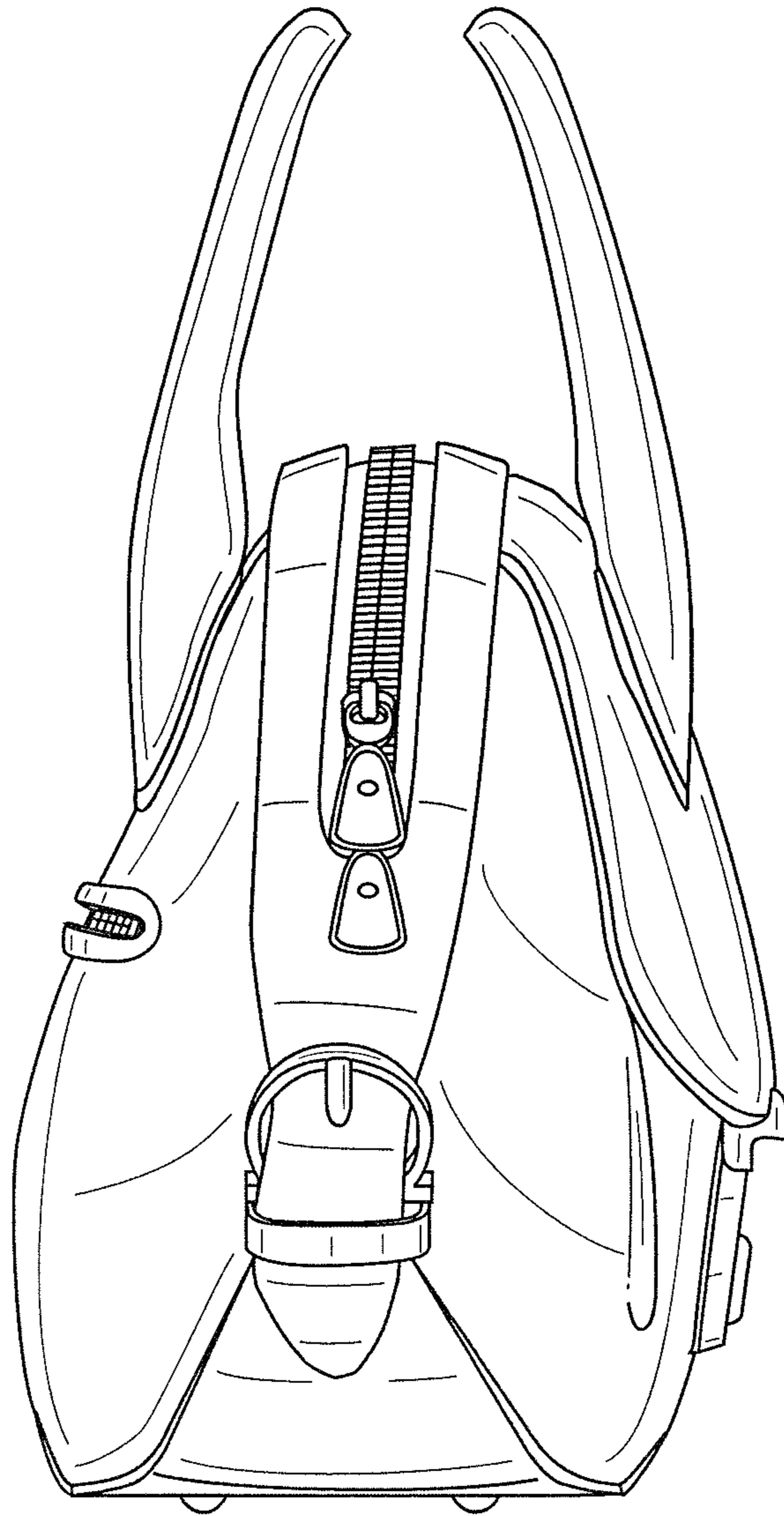

FIG. 5

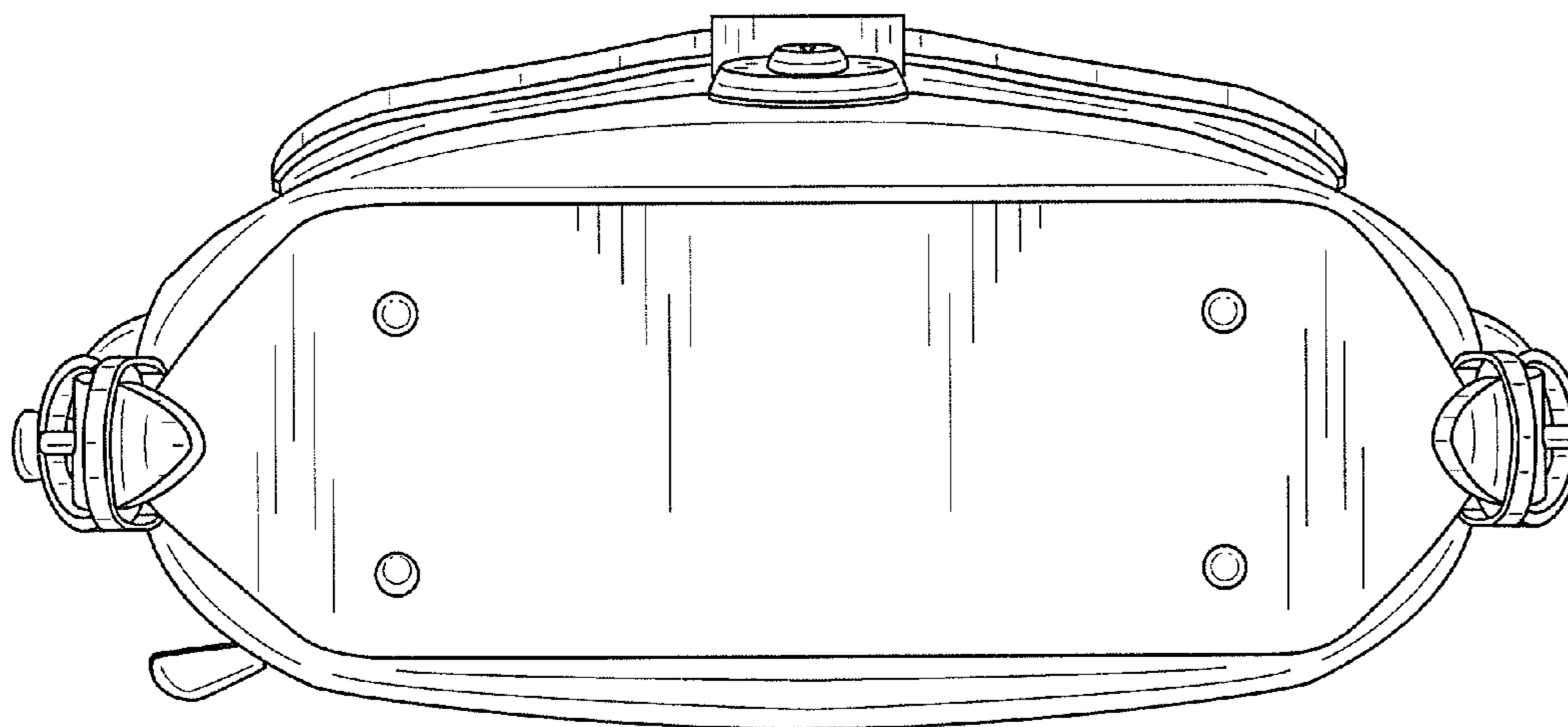

FIG. 6

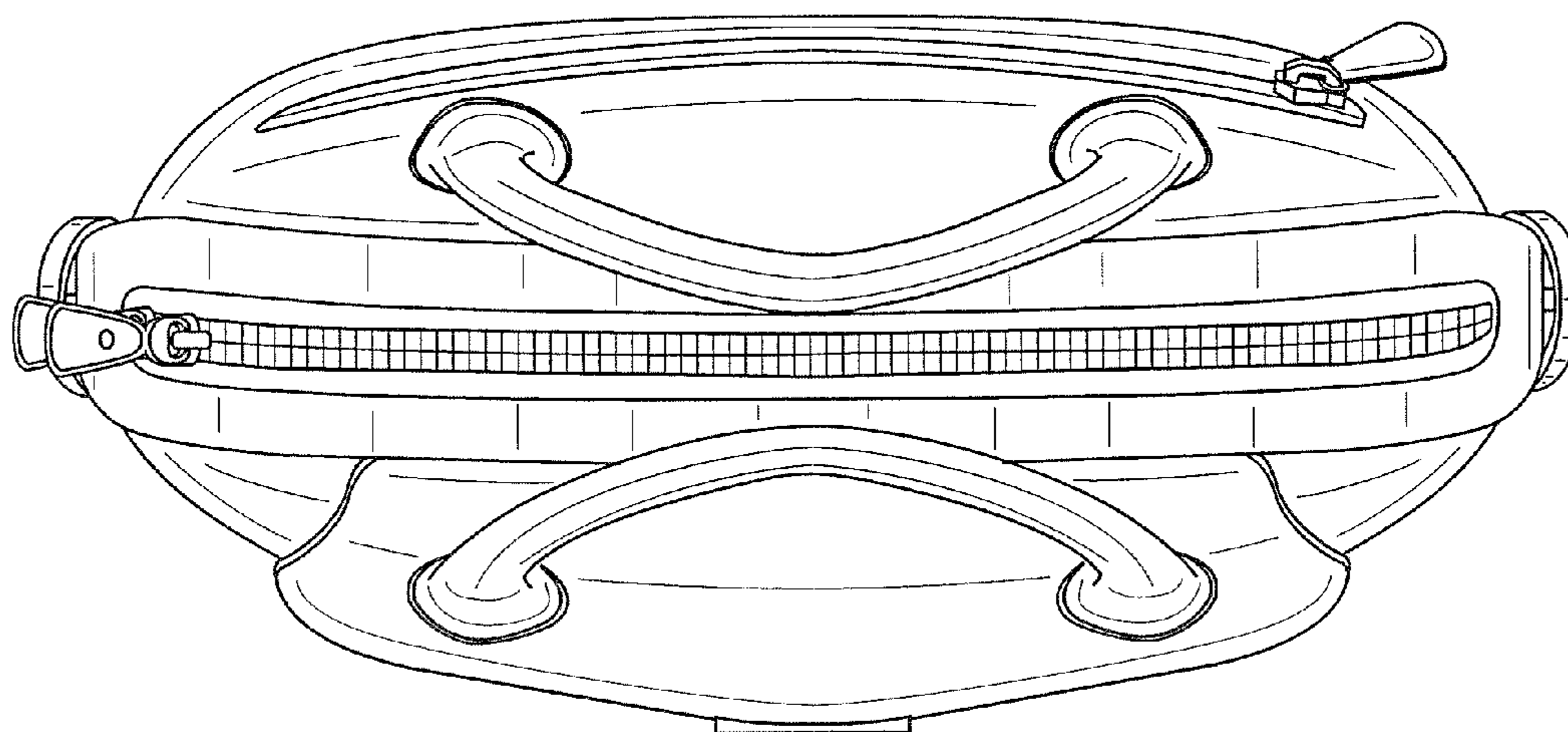

FIG. 7