

US00D753388S

(12) **United States Design Patent**  
**Enders-Tretter**

(10) **Patent No.:** **US D753,388 S**

(45) **Date of Patent:** **\*\* \*Apr. 12, 2016**

(54) **HANDBAG**

(71) Applicant: **Kelly Enders-Tretter**, Lake Oswego,  
OR (US)

(72) Inventor: **Kelly Enders-Tretter**, Lake Oswego,  
OR (US)

(\*) Notice: This patent is subject to a terminal dis-  
claimer.

(\*\*) Term: **14 Years**

(21) Appl. No.: **29/457,528**

(22) Filed: **Jun. 11, 2013**

(51) **LOC (10) Cl.** ..... **03-01**

(52) **U.S. Cl.**  
USPC ..... **D3/245**

(58) **Field of Classification Search**  
USPC ..... D3/232–233, 240–243, 245–246  
CPC ..... A45C 3/06; A45C 1/024  
See application file for complete search history.

(56) **References Cited**

**U.S. PATENT DOCUMENTS**

D539,536 S \* 4/2007 Guyon et al. .... D3/243  
D547,061 S \* 7/2007 Gerbi ..... D3/243

D564,225 S \* 3/2008 Morelli ..... D3/246  
D578,754 S \* 10/2008 Sassi ..... D3/246  
D660,586 S \* 5/2012 Maramotti ..... D3/232  
D666,809 S \* 9/2012 Hermann ..... D3/232  
2010/0252154 A1 10/2010 Enders-Tretter

\* cited by examiner

*Primary Examiner* — Holly Baynham

(74) *Attorney, Agent, or Firm* — Mohr Intellectual Property  
Law Solutions, PC

(57) **CLAIM**

I claim the ornamental design for a handbag, as shown and  
described.

**DESCRIPTION**

FIG. 1 is a front elevation view of a handbag according to one  
embodiment.

FIG. 2 is a rear elevation view of the handbag.

FIG. 3 is a right side elevation view of the handbag.

FIG. 4 is a left side elevation view of the handbag.

FIG. 5 is a top elevation view of the handbag.

FIG. 6 is a bottom elevation view of the handbag; and,

FIG. 7 is a front perspective view of the handbag.

The claimed ornamental design is shown in solid lines with  
stitching depicted in dashed lines.

**1 Claim, 6 Drawing Sheets**

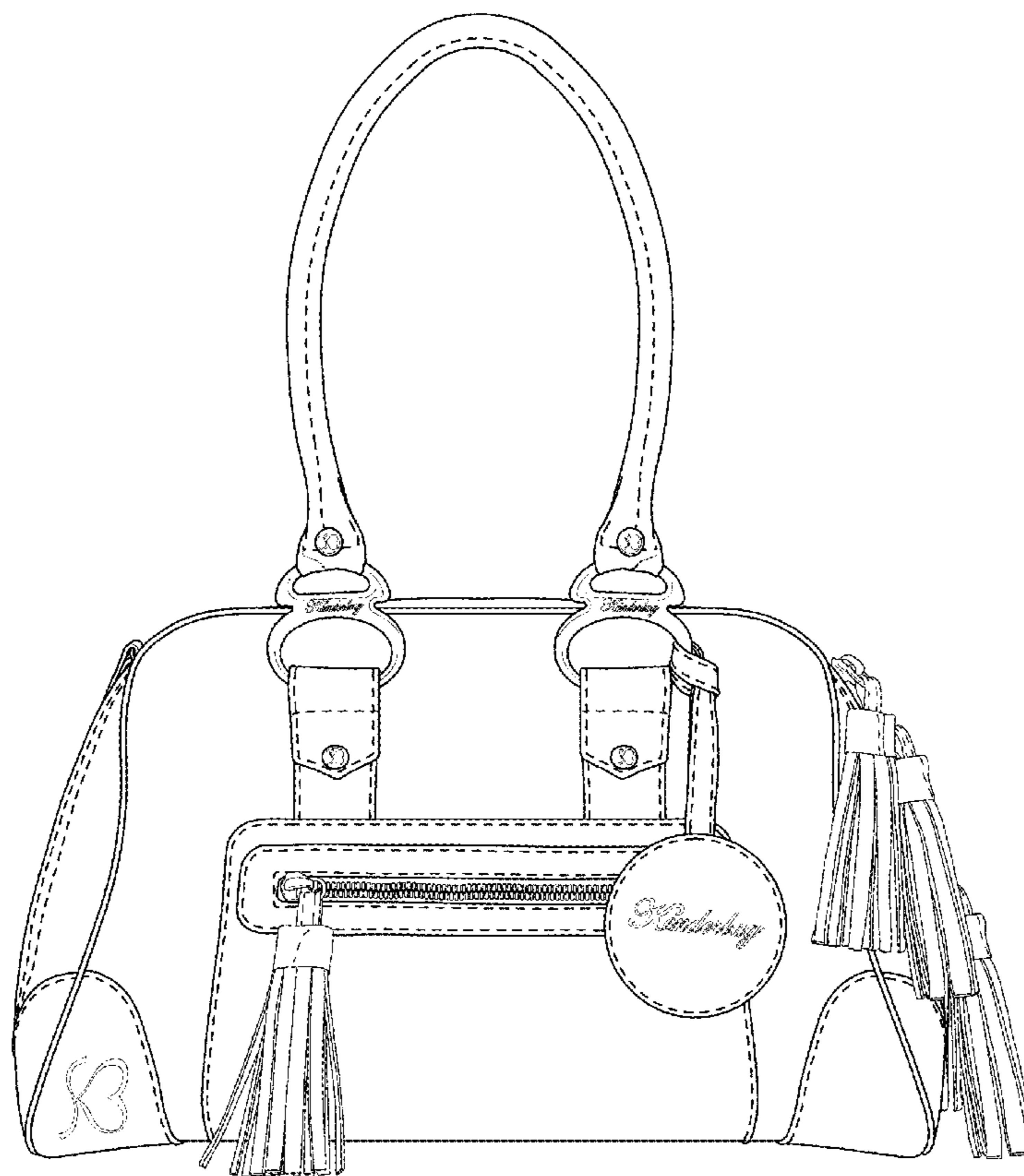



FIG. 1

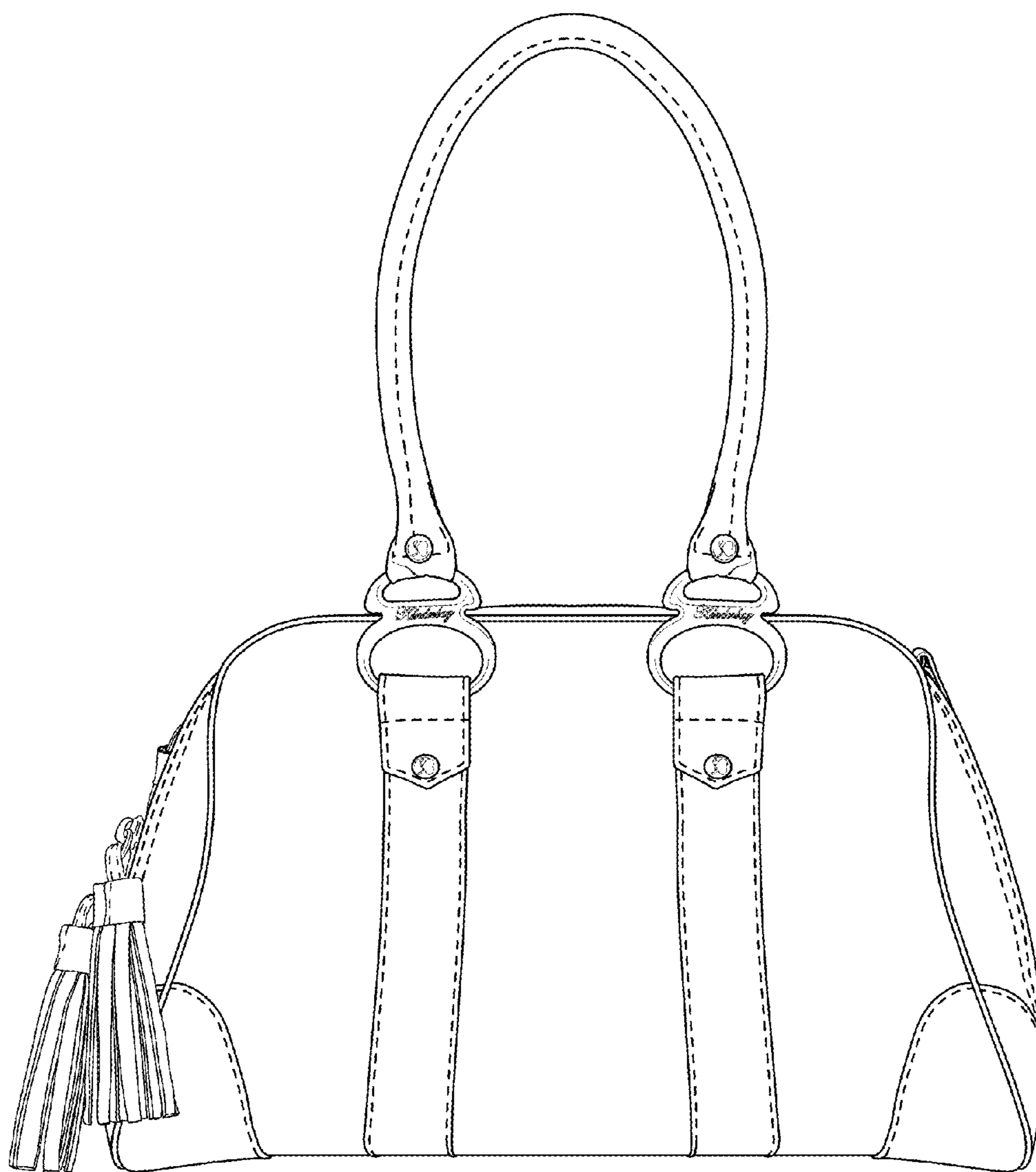

FIG. 2

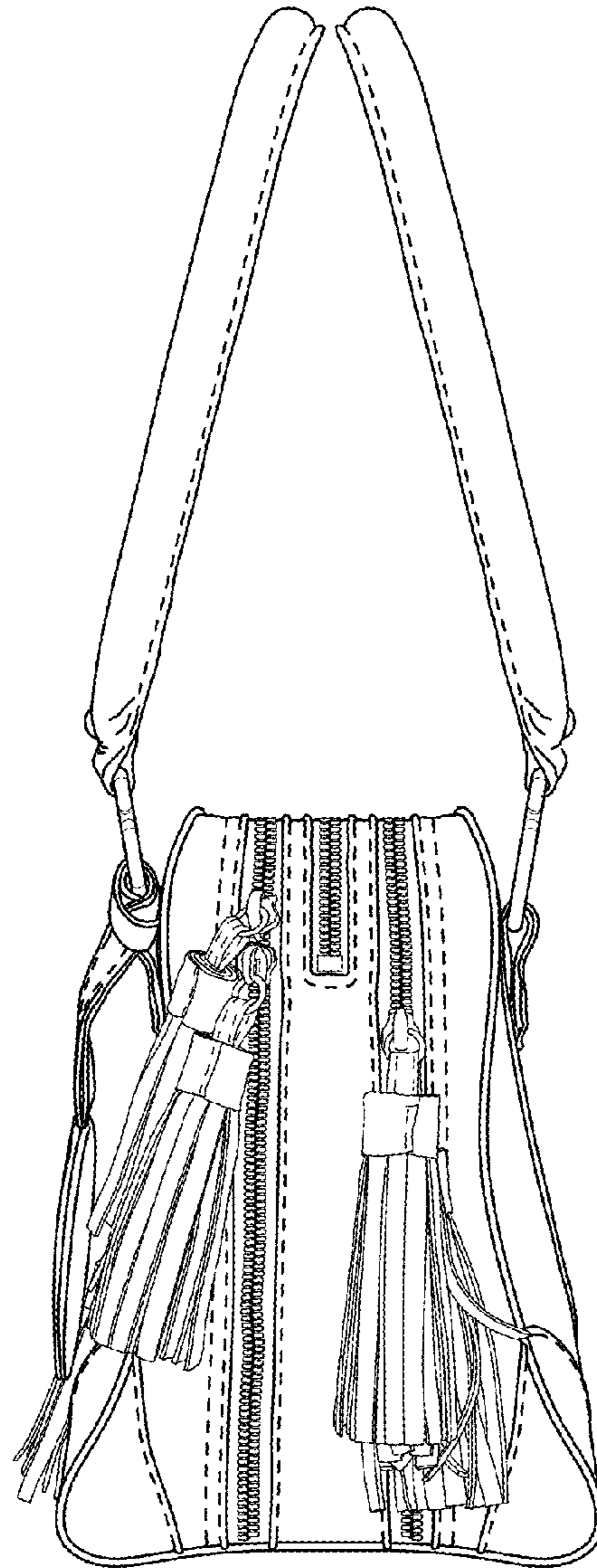

FIG.3

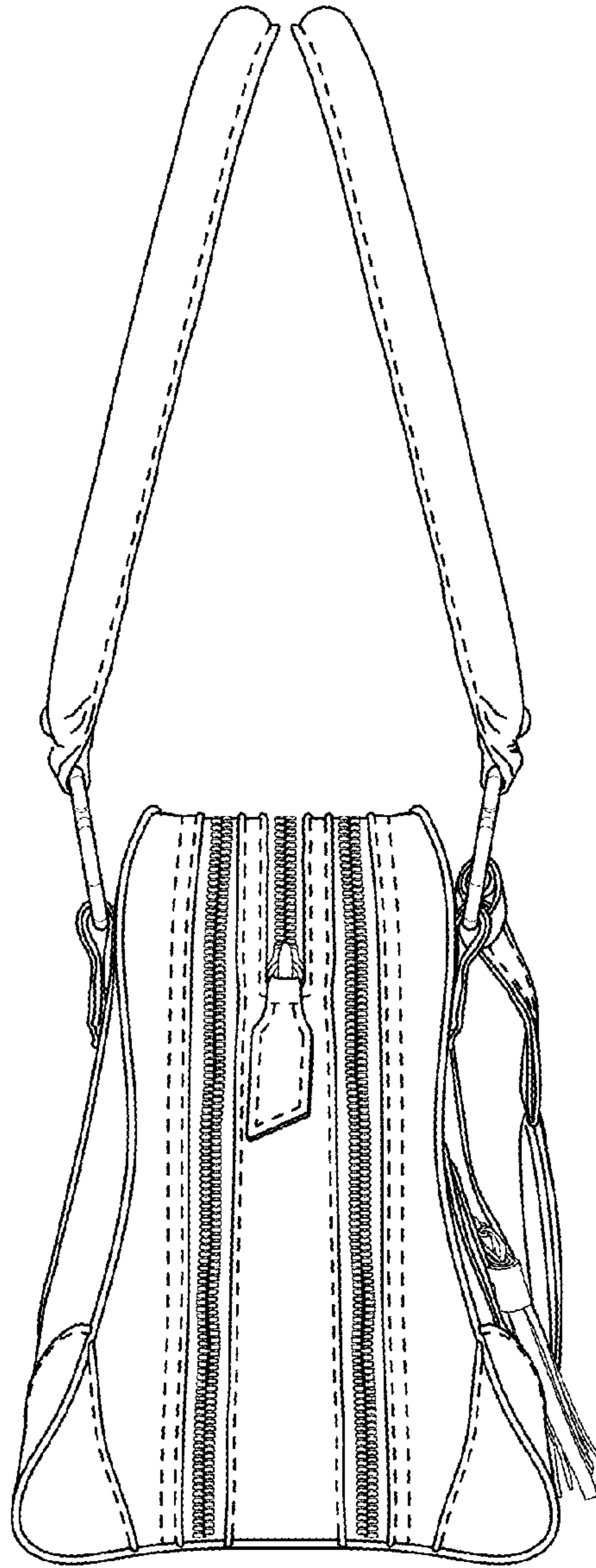

FIG.4

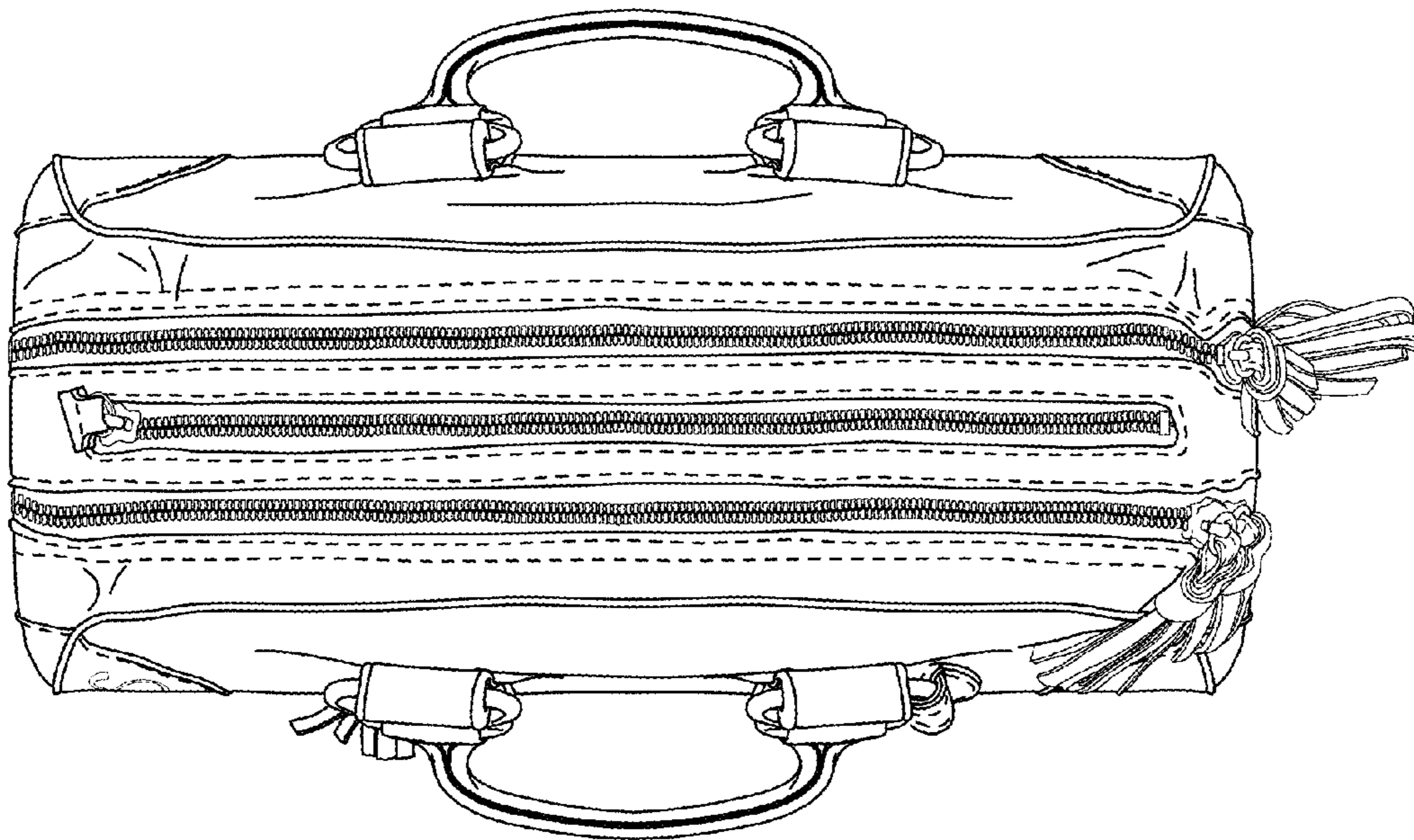

FIG. 5

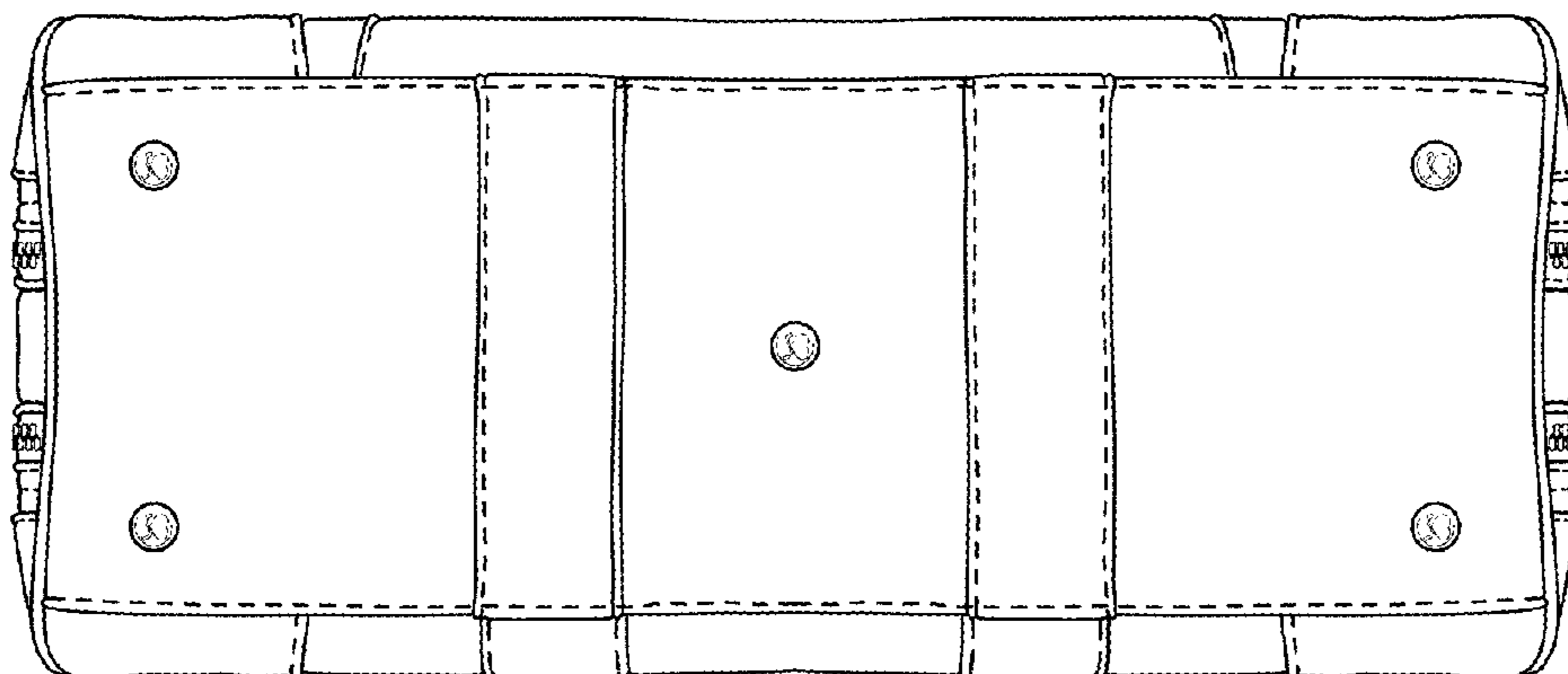

FIG. 6

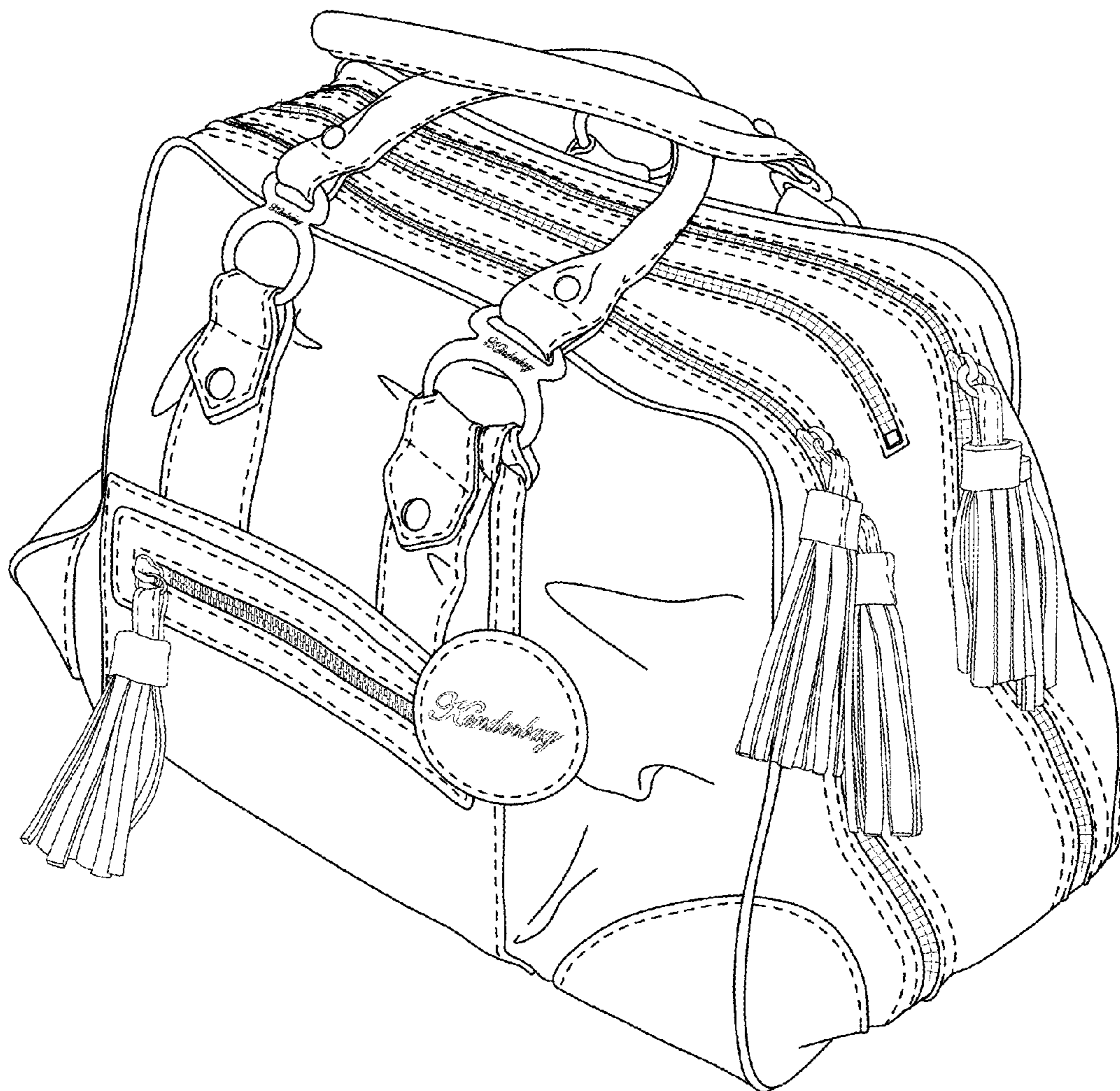

FIG.7