



US00D753342S

(12) **United States Design Patent**
Okabe

(10) **Patent No.:** **US D753,342 S**
(45) **Date of Patent:** **** Apr. 5, 2016**

(54) **ELECTRIC SHAVER**

(71) Applicant: **Panasonic Intellectual Property Management Co., Ltd.**, Osaka-shi, Osaka (JP)

(72) Inventor: **Kensaku Okabe**, Osaka (JP)

(73) Assignee: **PANASONIC INTELLECTUAL PROPERTY MANAGEMENT CO., LTD.**, Osaka (JP)

(**) Term: **14 Years**

(21) Appl. No.: **29/521,191**

(22) Filed: **Mar. 20, 2015**

(30) **Foreign Application Priority Data**

Dec. 18, 2014 (JP) 2014-028256
Dec. 18, 2014 (JP) 2014-028257

(51) **LOC (10) Cl.** **28-03**

(52) **U.S. Cl.**
USPC **D28/51**

(58) **Field of Classification Search**
USPC D28/44.1, 49-54
CPC B26B 19/00; B26B 19/02-19/107;
B26B 19/12; B26B 19/14-19/18; B26B
19/20-19/22; B26B 19/26-19/36; B26B
19/38-19/48; B26B 21/10-21/12
See application file for complete search history.

(56) **References Cited**

U.S. PATENT DOCUMENTS

D511,398 S * 11/2005 Nishizawa D28/49
D513,541 S * 1/2006 Nishizawa D28/49
D571,956 S * 6/2008 Nishizawa D28/49
7,794,276 B2 * 9/2010 Shigeta B26B 19/3833
439/205
D648,482 S * 11/2011 Kim D28/50
D648,483 S * 11/2011 Ino D28/51
D648,486 S * 11/2011 Ino D28/54
D648,896 S * 11/2011 Ino D28/54

D657,912 S * 4/2012 Yoon D28/54
8,347,508 B2 * 1/2013 Shimizu B26B 19/048
30/45
8,479,397 B2 * 7/2013 Sato B26B 19/046
30/346.51
D689,242 S * 9/2013 Grabes D28/54
D696,458 S * 12/2013 Ino D28/51

(Continued)

FOREIGN PATENT DOCUMENTS

CN 302459400 6/2013
JP D1408759 S 3/2011
JP D1451896 S 9/2012

Primary Examiner — Jennifer Rivard

(74) *Attorney, Agent, or Firm* — Brinks Gilson & Lione

(57) **CLAIM**

I claim the ornamental design for an electric shaver, as shown and described.

DESCRIPTION

FIG. 1 is a top and front perspective view of a first embodiment of an electric shaver of the present invention; FIG. 2 is a top and rear perspective view thereof; FIG. 3 is a front view thereof; FIG. 4 is a rear view thereof; FIG. 5 is a first side view thereof; FIG. 6 is a second side view thereof; FIG. 7 is a top view thereof; FIG. 8 is a bottom view thereof; FIG. 9 is a top and front perspective view of a second embodiment of an electric shaver of the present invention; FIG. 10 is a top and rear perspective view thereof; FIG. 11 is a front view thereof; FIG. 12 is a rear view thereof; FIG. 13 is a first side view thereof; FIG. 14 is a second side view thereof; FIG. 15 is a top view thereof; and, FIG. 16 is a bottom view thereof.

The broken lines shown represent unclaimed subject matter and form no part of the claimed design. Additionally, the unevenly broken lines in the drawings define the limits of the claimed design.

1 Claim, 16 Drawing Sheets

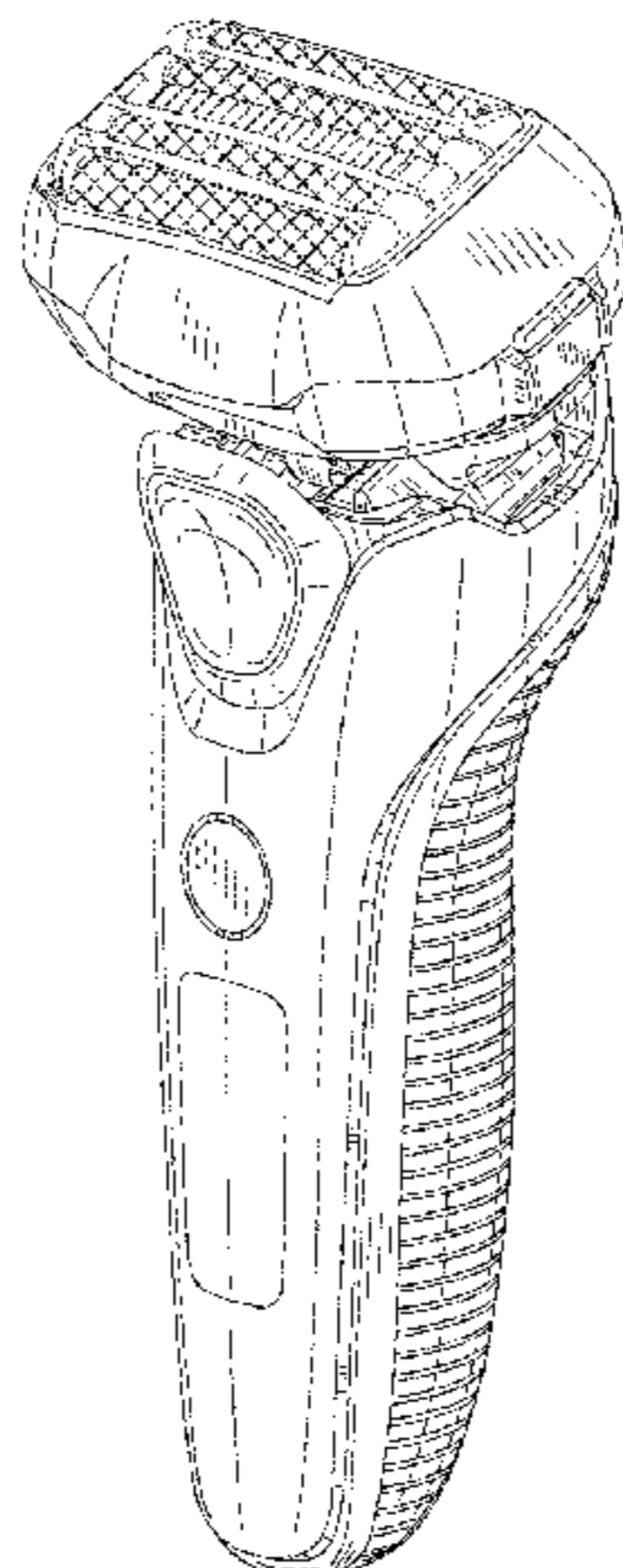

(56)

References Cited

U.S. PATENT DOCUMENTS

| | | | | | | |
|--------------|------|---------|-----------|-------|-------------|-----------|
| 8,627,574 | B2 * | 1/2014 | Shimizu | | B26B 19/048 | 30/42 |
| D702,882 | S * | 4/2014 | Grabes | | D28/51 | |
| 8,720,069 | B2 * | 5/2014 | Iwashita | | B26B 19/048 | 30/346.51 |
| D713,994 | S * | 9/2014 | Grabes | | D28/54 | |
| D717,996 | S * | 11/2014 | Kikuchi | | D28/51 | |
| D718,495 | S * | 11/2014 | Okabe | | D28/51 | |
| D718,900 | S * | 12/2014 | Kikuchi | | D28/54 | |
| 2008/0134515 | A1 * | 6/2008 | Sato | | B26B 19/046 | 30/43.91 |
| 2010/0180447 | A1 * | 7/2010 | Sato | | B26B 19/04 | 30/43.92 |
| 2010/0180448 | A1 * | 7/2010 | Sato | | B26B 19/048 | 30/43.92 |
| 2010/0269350 | A1 * | 10/2010 | Iwashita | | B26B 19/048 | 30/43.92 |
| 2013/0097871 | A1 * | 4/2013 | Yamaguchi | | B26B 19/28 | 30/45 |

* cited by examiner

FIG. 1

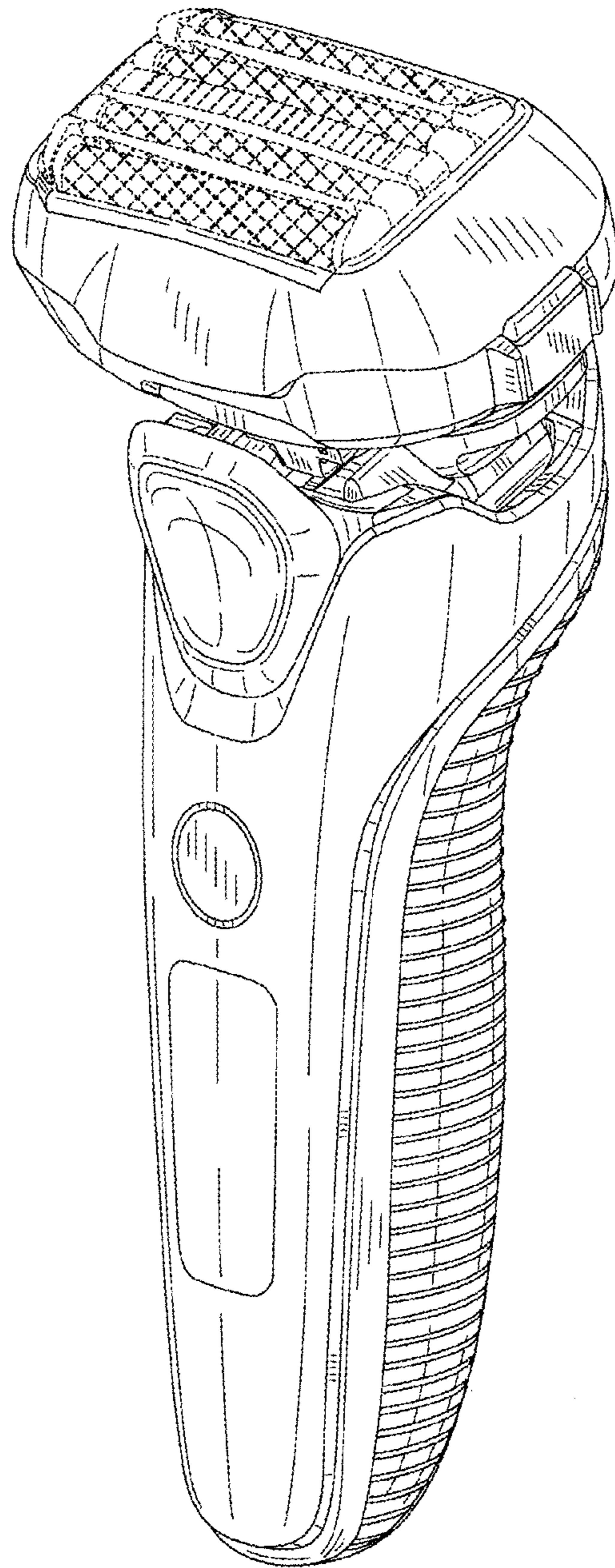

FIG.2

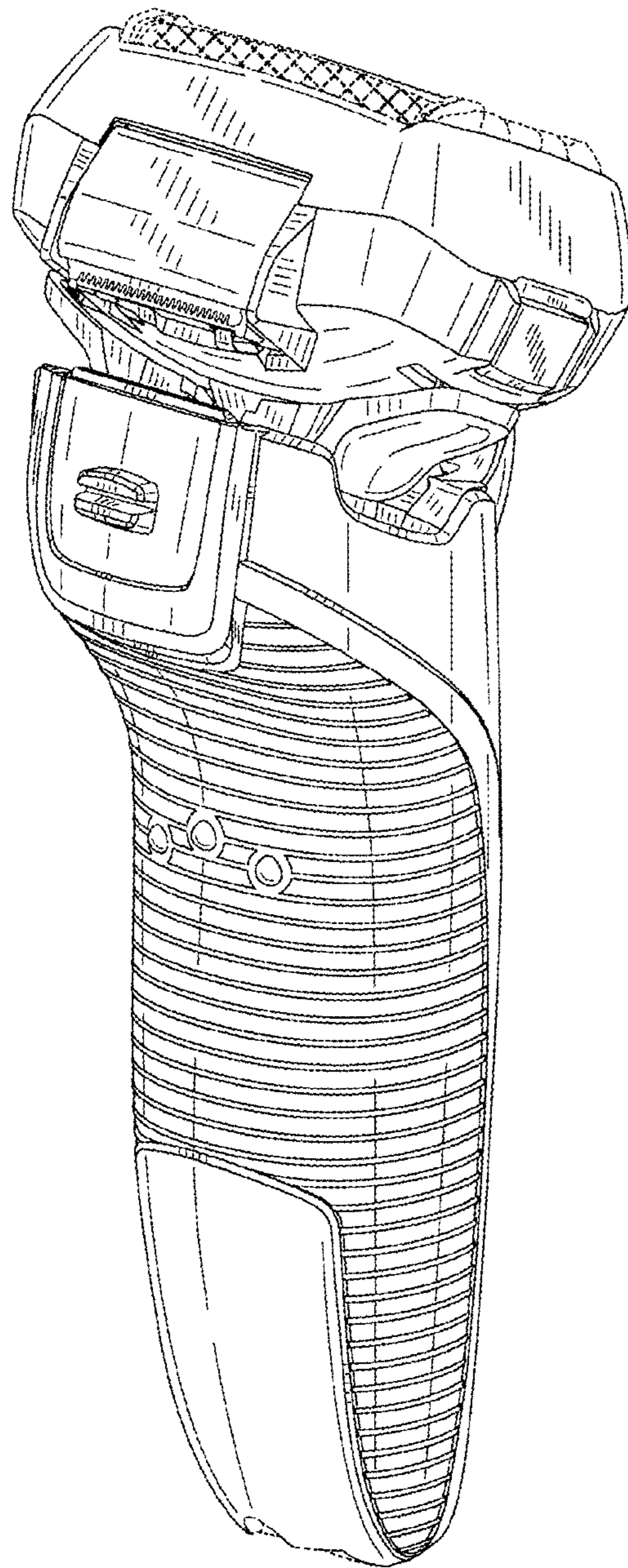

FIG.3

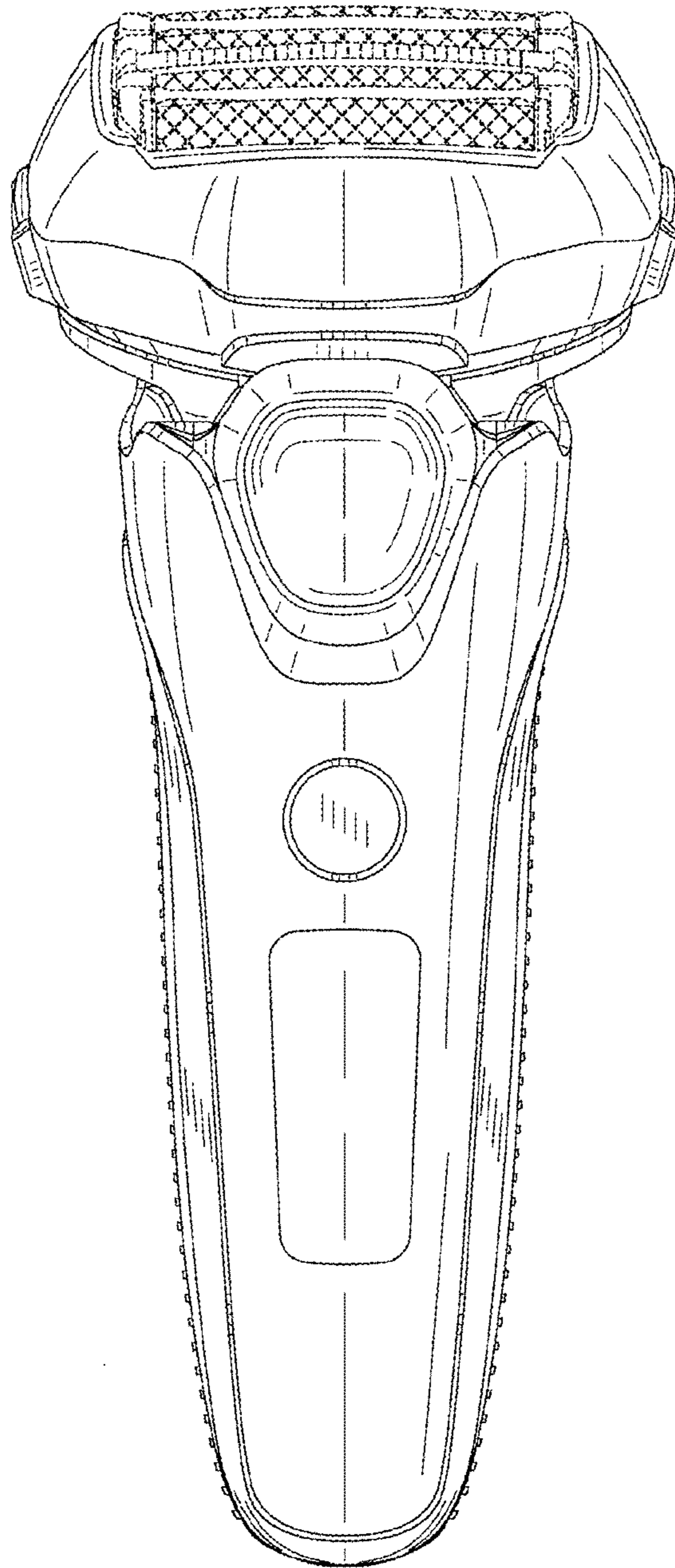

FIG.4

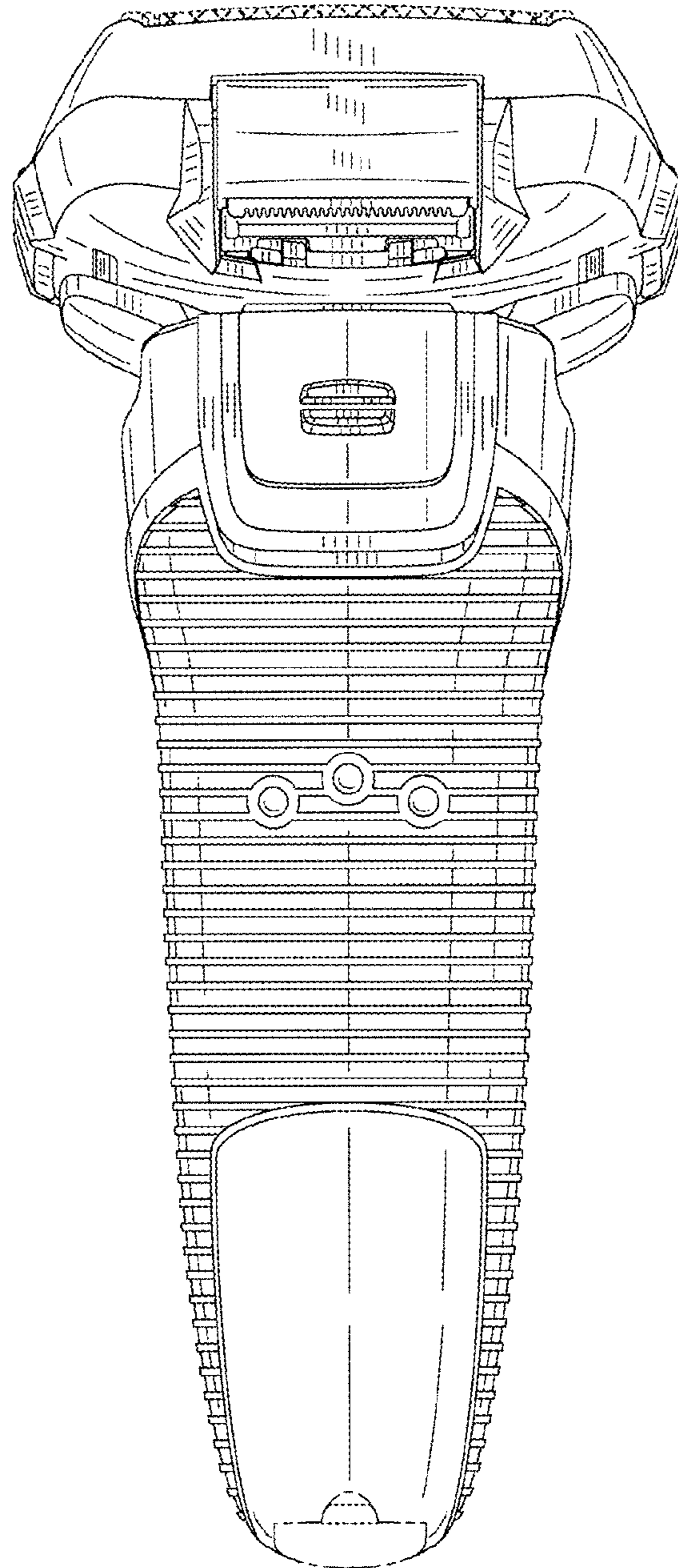

FIG. 5

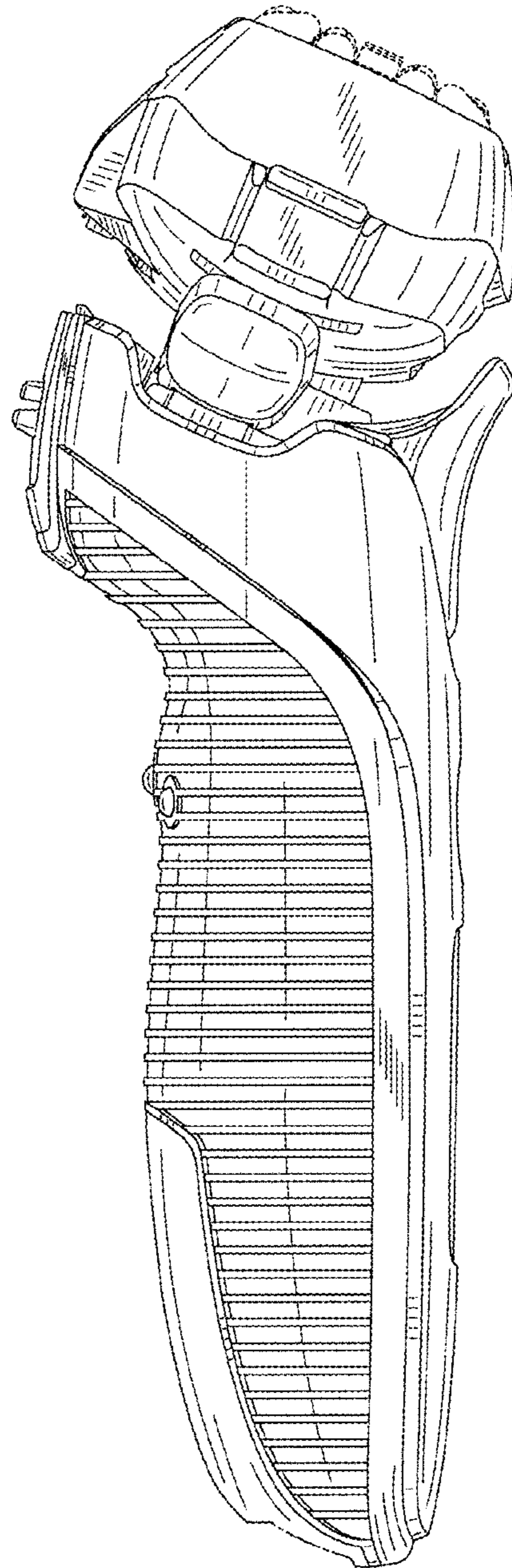

FIG.6

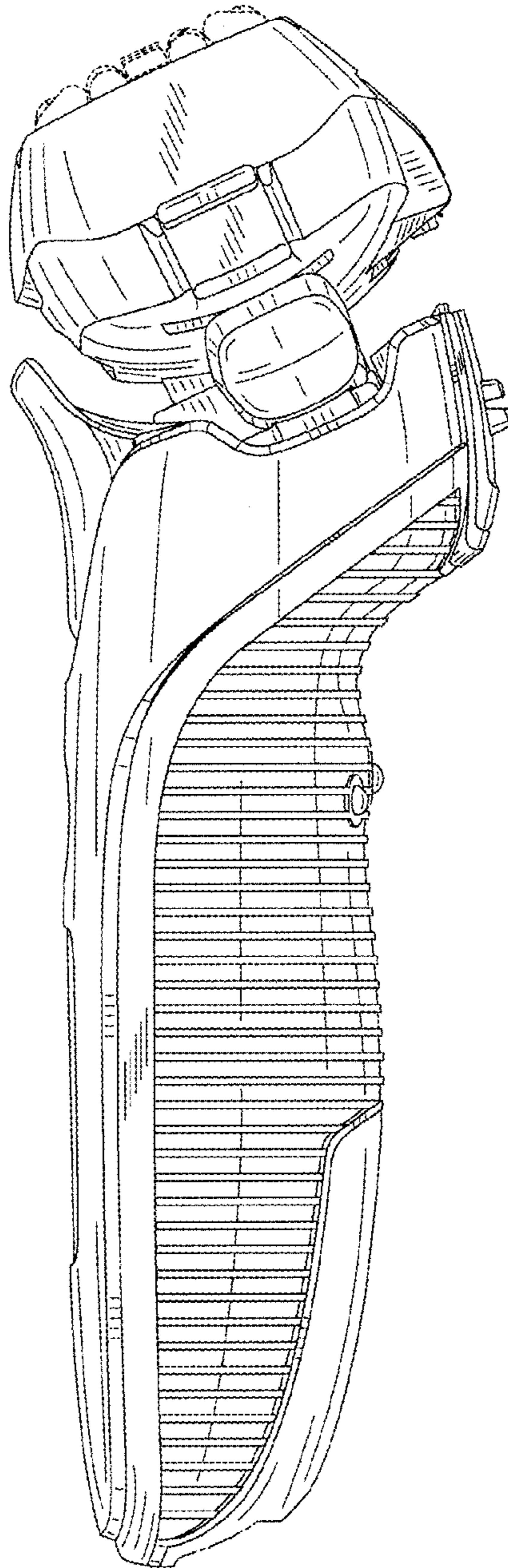

FIG.7

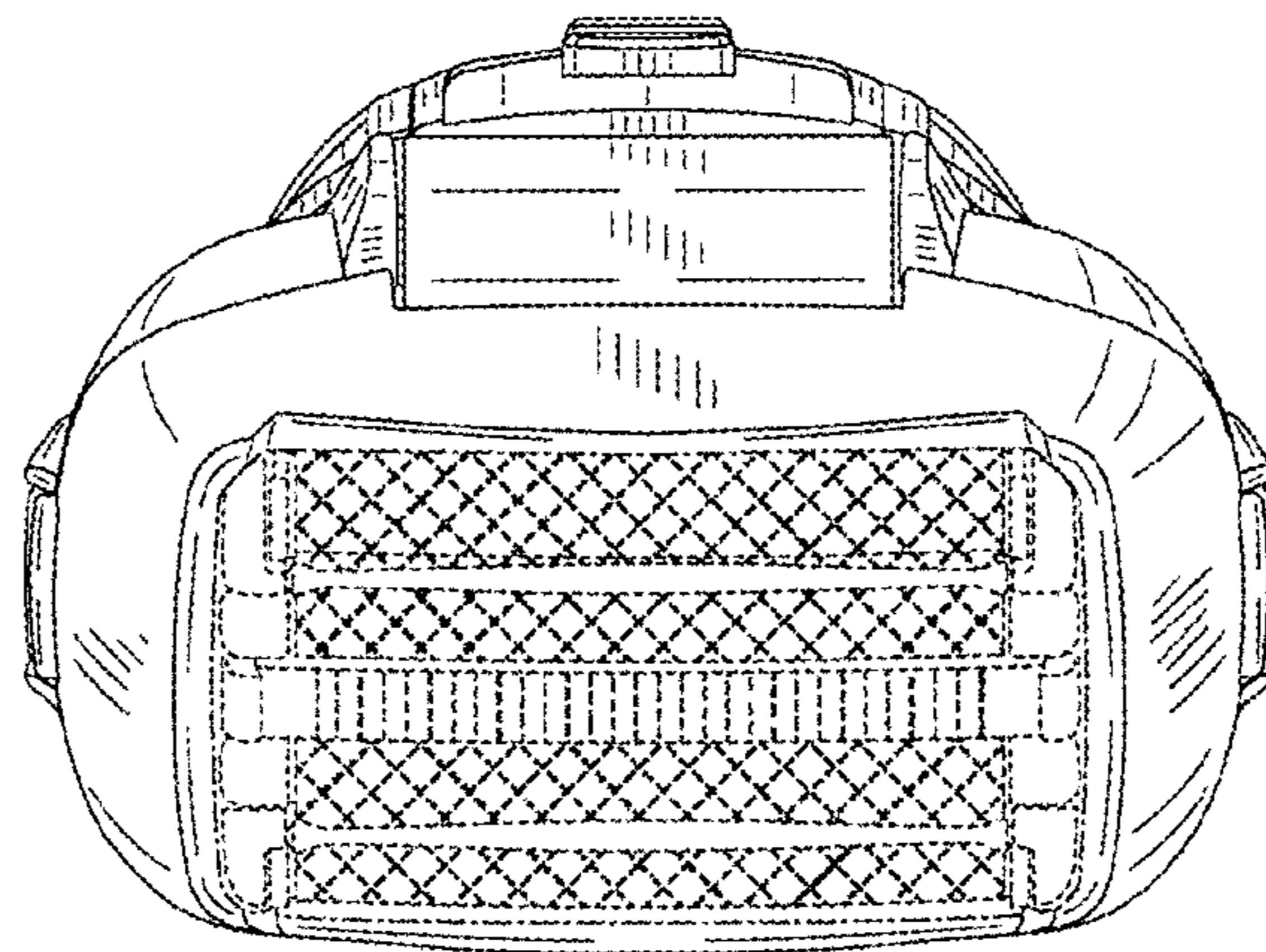

FIG.8

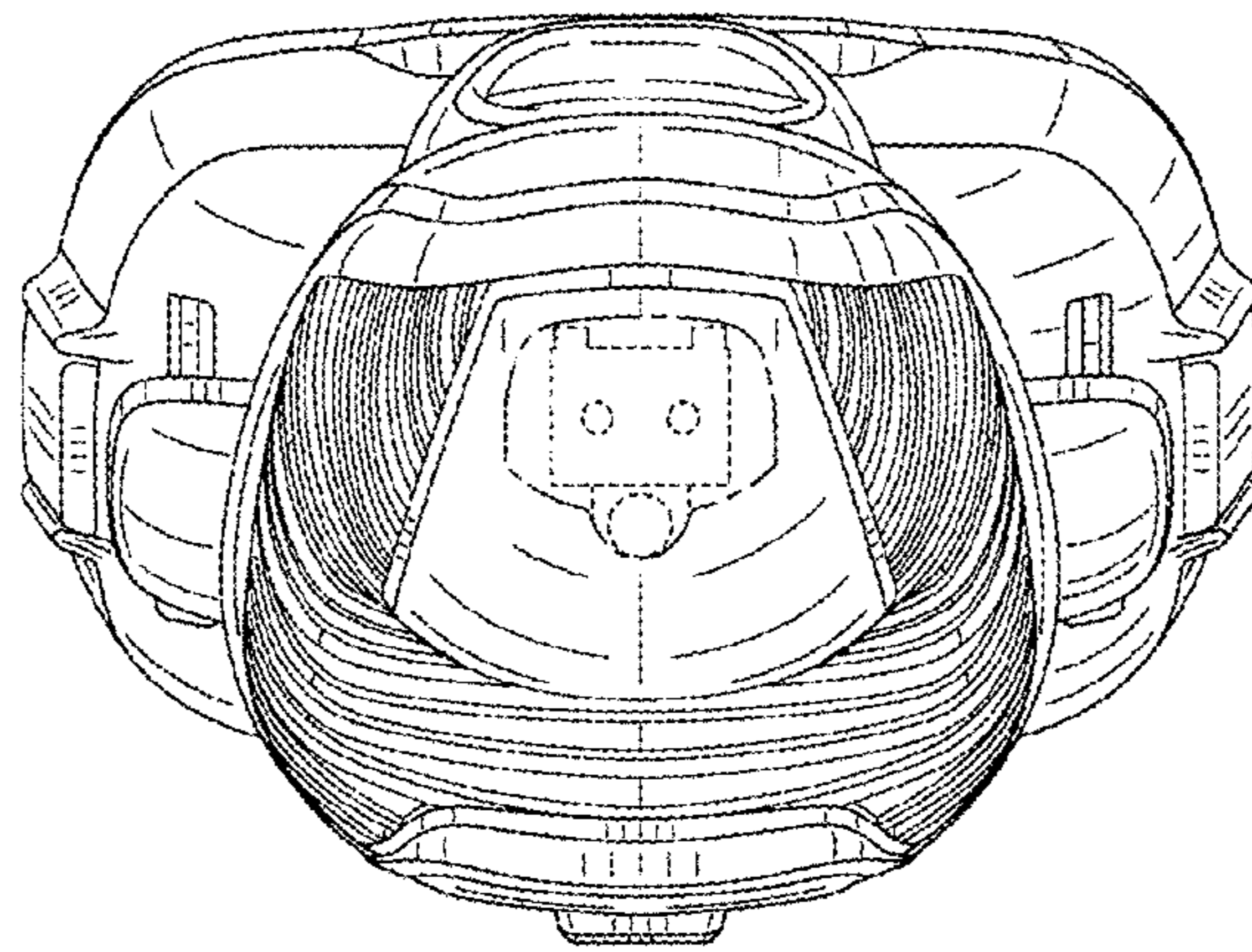

FIG.9

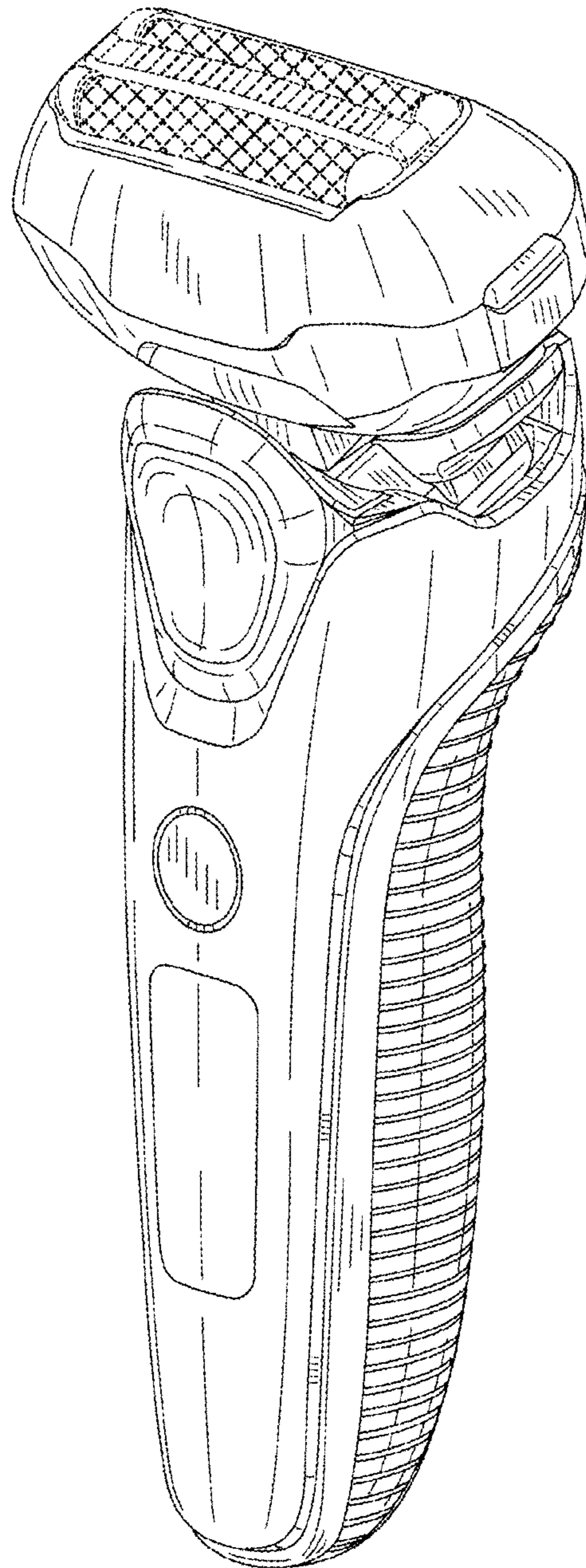

FIG.10

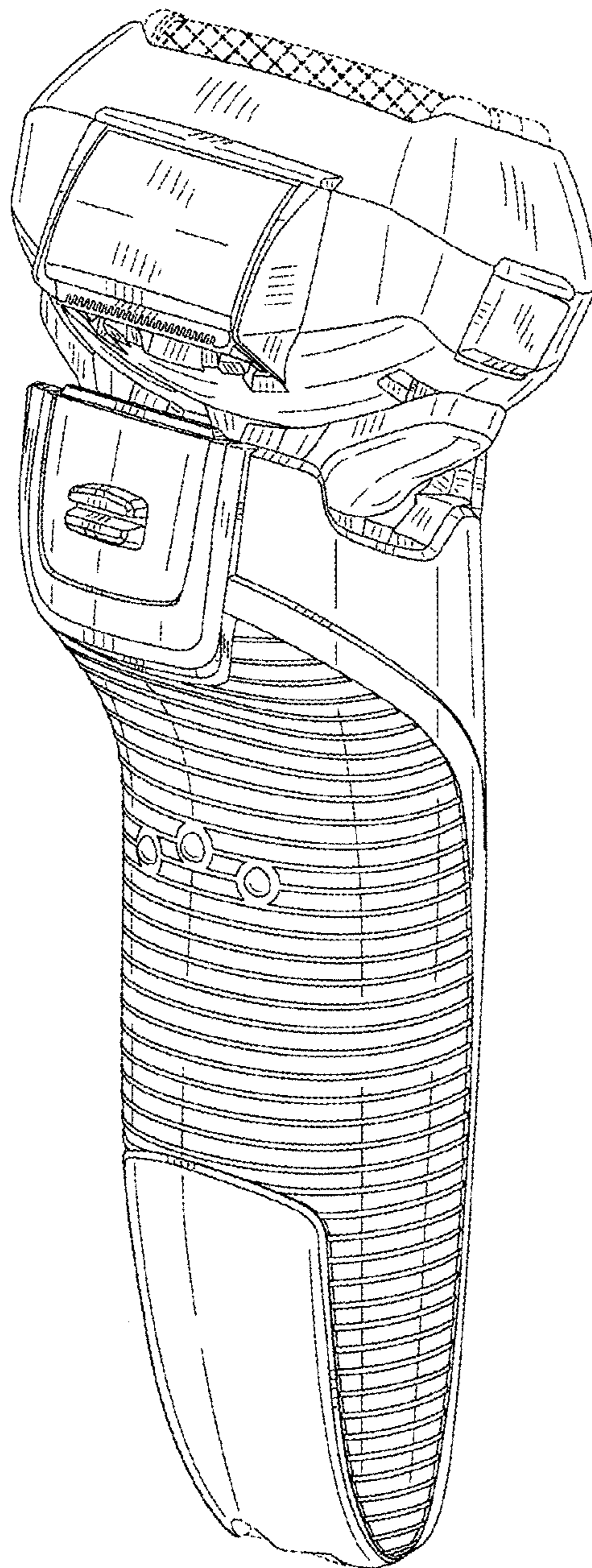

FIG.11

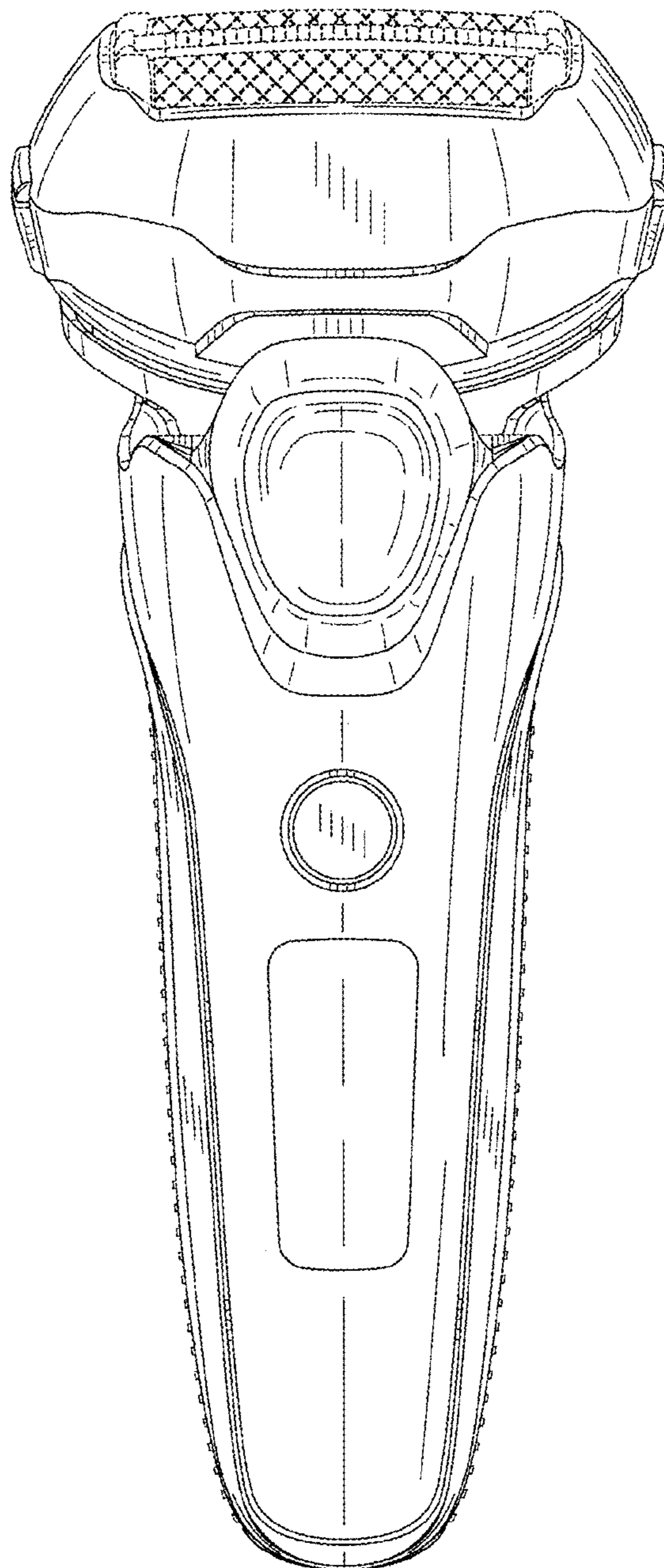

FIG.12

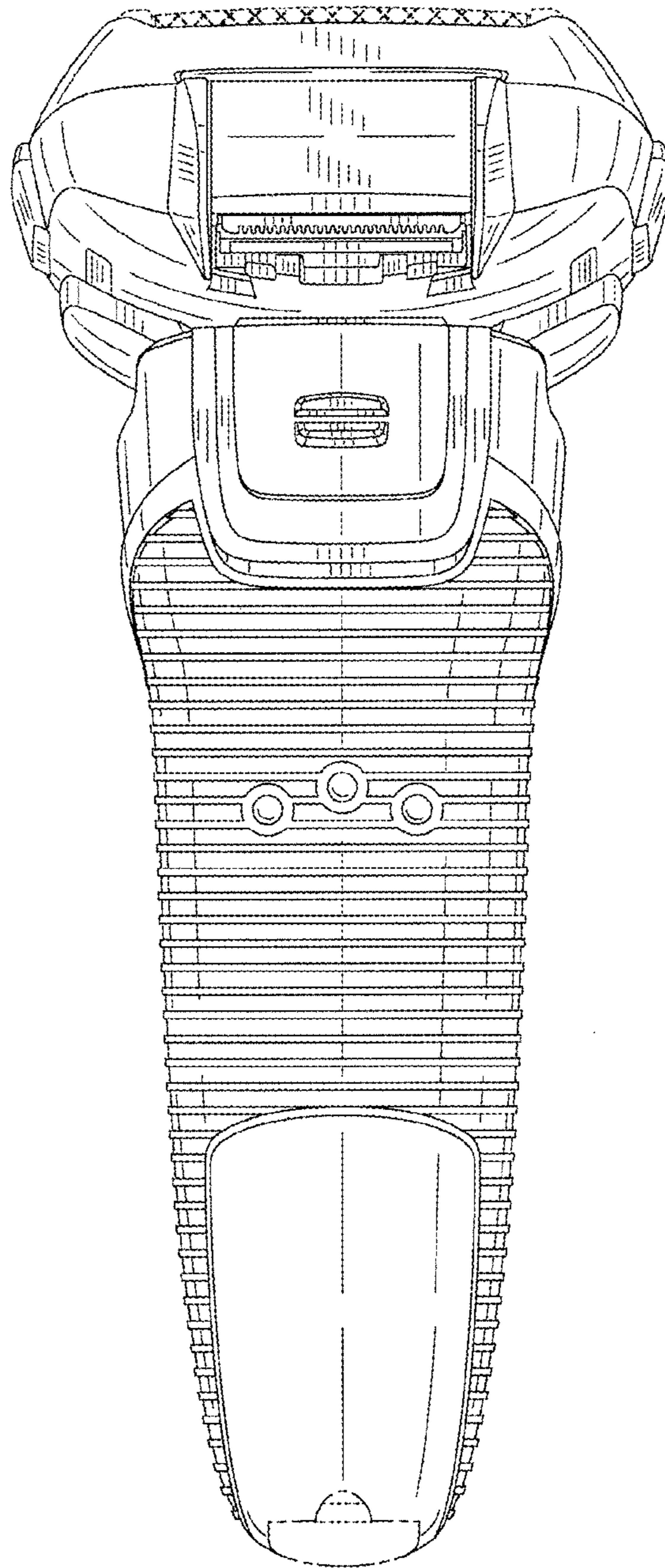

FIG.13

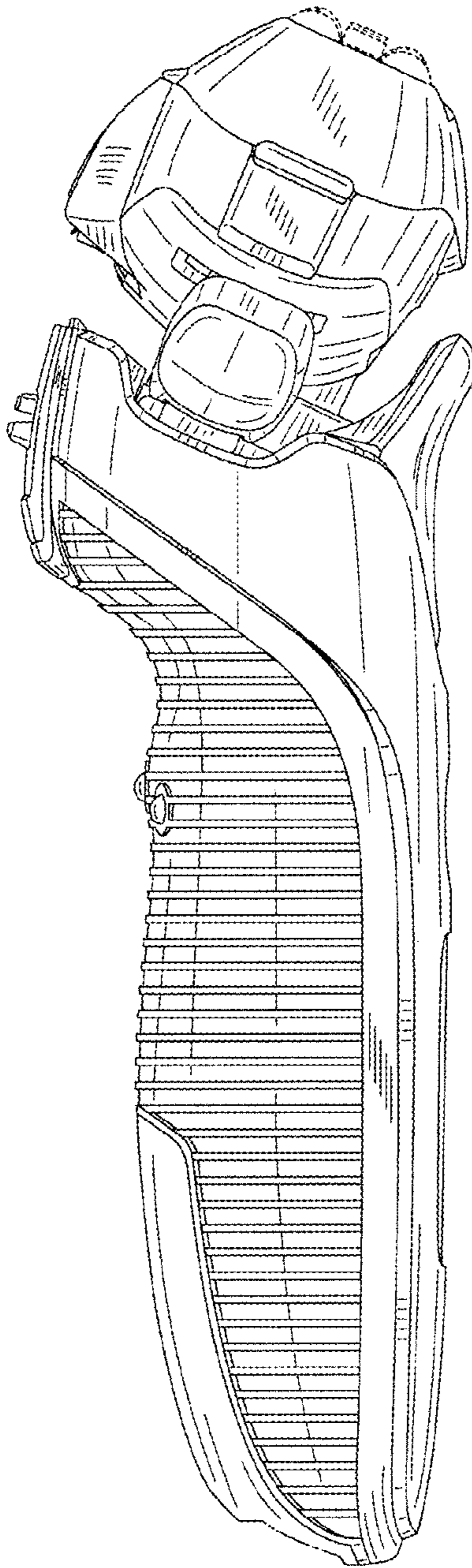

FIG. 14

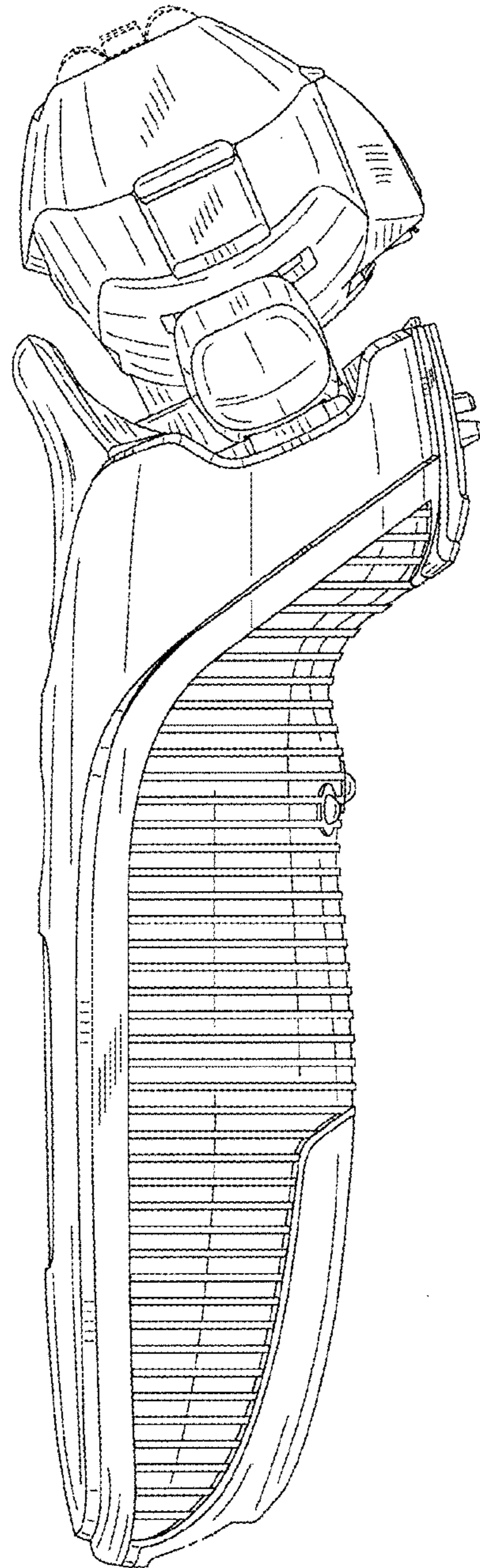

FIG.15

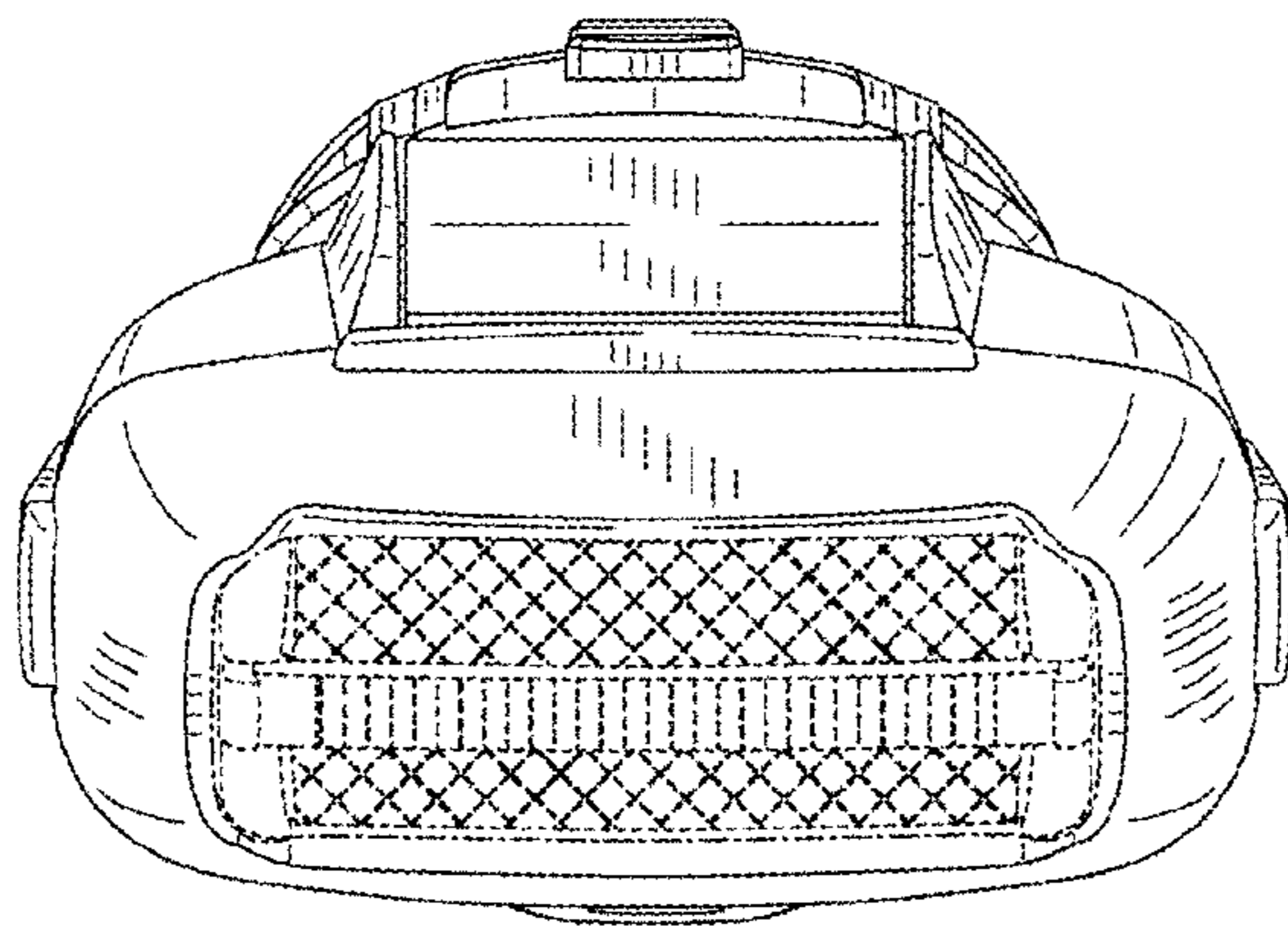

FIG.16

