



US00D753270S

(12) **United States Design Patent**  
**Coronado**

(10) **Patent No.:** **US D753,270 S**  
(45) **Date of Patent:** **\*\* Apr. 5, 2016**

(54) **ELBOW PIECE WITH DRAINAGE BRANCH AND FLEXIBLE HOSE**

(71) Applicant: **Coflex S.A. de C.V.**, Monterrey, Nuevo Leon (MX)

(72) Inventor: **Eduardo Coronado**, San Pedro Garza Garcia (MX)

(73) Assignee: **COFLEX S.A. DE C.V.** (MX)

(\*\*) Term: **14 Years**

(21) Appl. No.: **29/514,298**

(22) Filed: **Jan. 9, 2015**

(51) **LOC (10) Cl.** ..... **23-01**

(52) **U.S. Cl.**  
USPC ..... **D23/262**

(58) **Field of Classification Search**  
USPC ..... D23/209, 233, 235, 238, 249, 253, 254, D23/257, 259-269, 303, 304, 308; D12/197; D9/435  
CPC ..... B01D 35/04; B01D 29/13; B01D 29/19; B01D 36/006; B01D 2201/295; B01D 2201/304; F02M 37/221; A47K 3/28; A47K 3/30; A47K 3/281; A47K 3/283; E03C 1/20; E03C 1/26; E03C 1/28; E03C 1/122; E03C 1/262; E03C 1/292; E03F 5/02; E03F 5/04; F16L 37/252; F16L 41/007; F16L 43/008; F16L 55/07; F16L 25/0036; B08B 9/032  
See application file for complete search history.

(56) **References Cited**

**U.S. PATENT DOCUMENTS**

2,911,001 A \* 11/1959 Fuller ..... B08B 9/032 137/362  
4,165,110 A \* 8/1979 Itzler ..... F16L 27/11 138/121  
4,722,556 A \* 2/1988 Todd ..... F16L 25/0036 285/12  
4,796,926 A \* 1/1989 Rapsilver ..... F16L 35/005 141/311 R

D443,863 S \* 6/2001 Maccarone ..... D13/155  
D456,494 S \* 4/2002 Whitfield ..... D23/259  
D636,468 S \* 4/2011 Ball ..... D23/262  
D674,883 S \* 1/2013 Ball ..... D23/266  
2008/0196161 A1\* 8/2008 Ball ..... E03C 1/232 4/680

(Continued)

*Primary Examiner* — George D Kirschbaum

*Assistant Examiner* — Amy Wierenga

(74) *Attorney, Agent, or Firm* — Baker & McKenzie LLP

(57) **CLAIM**

The ornamental design for an elbow piece with drainage branch and flexible hose, as shown and described.

**DESCRIPTION**

FIG. 1 is a perspective view of an elbow piece with drainage branch and flexible hose that is unattached, shown in exemplary attachment to a second hose and elbow, in accordance with my design;  
FIG. 2 is a front view of FIG. 1;  
FIG. 3 is a back view of FIG. 1;  
FIG. 4 is a top view of FIG. 1;  
FIG. 5 is a bottom view of FIG. 1;  
FIG. 6 is a perspective view thereof with the flexible hose in an attached configuration, shown in exemplary attachment to a second hose and elbow;  
FIG. 7 is a front view of FIG. 6;  
FIG. 8 is a back view of FIG. 6;  
FIG. 9 is a top view of FIG. 6;  
FIG. 10 is a bottom view of FIG. 6;  
FIG. 11 is a perspective view thereof with the flexible hose in an attached configuration, shown in an exemplary attachment to a second hose;  
FIG. 12 is a front view of FIG. 11;  
FIG. 13 is a back view of FIG. 11;  
FIG. 14 is a top view of FIG. 11; and,  
FIG. 15 is a bottom view of FIG. 11.

The broken lines in the drawings depict environmental subject matter and form no part of the claim.

**1 Claim, 15 Drawing Sheets**

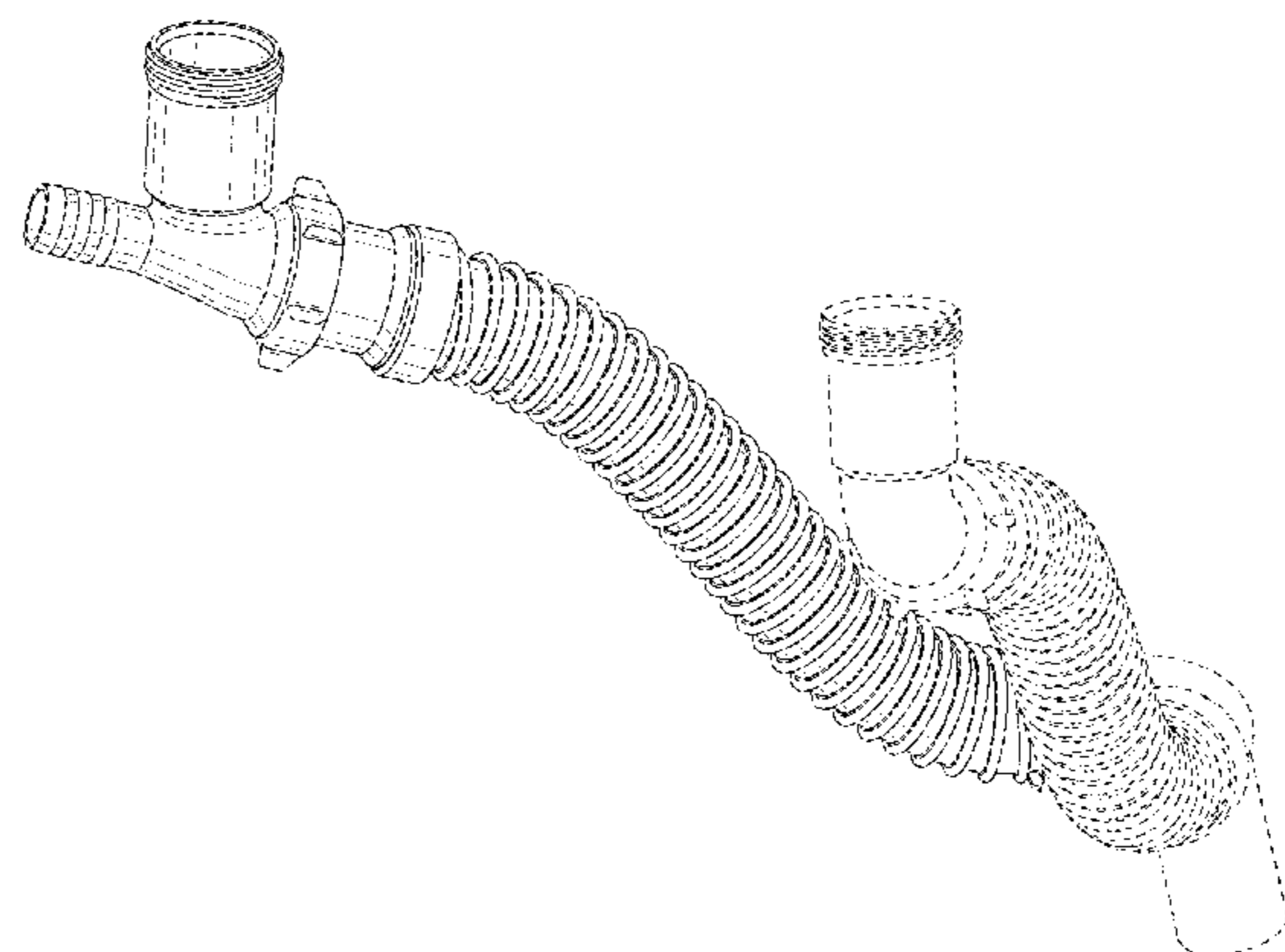
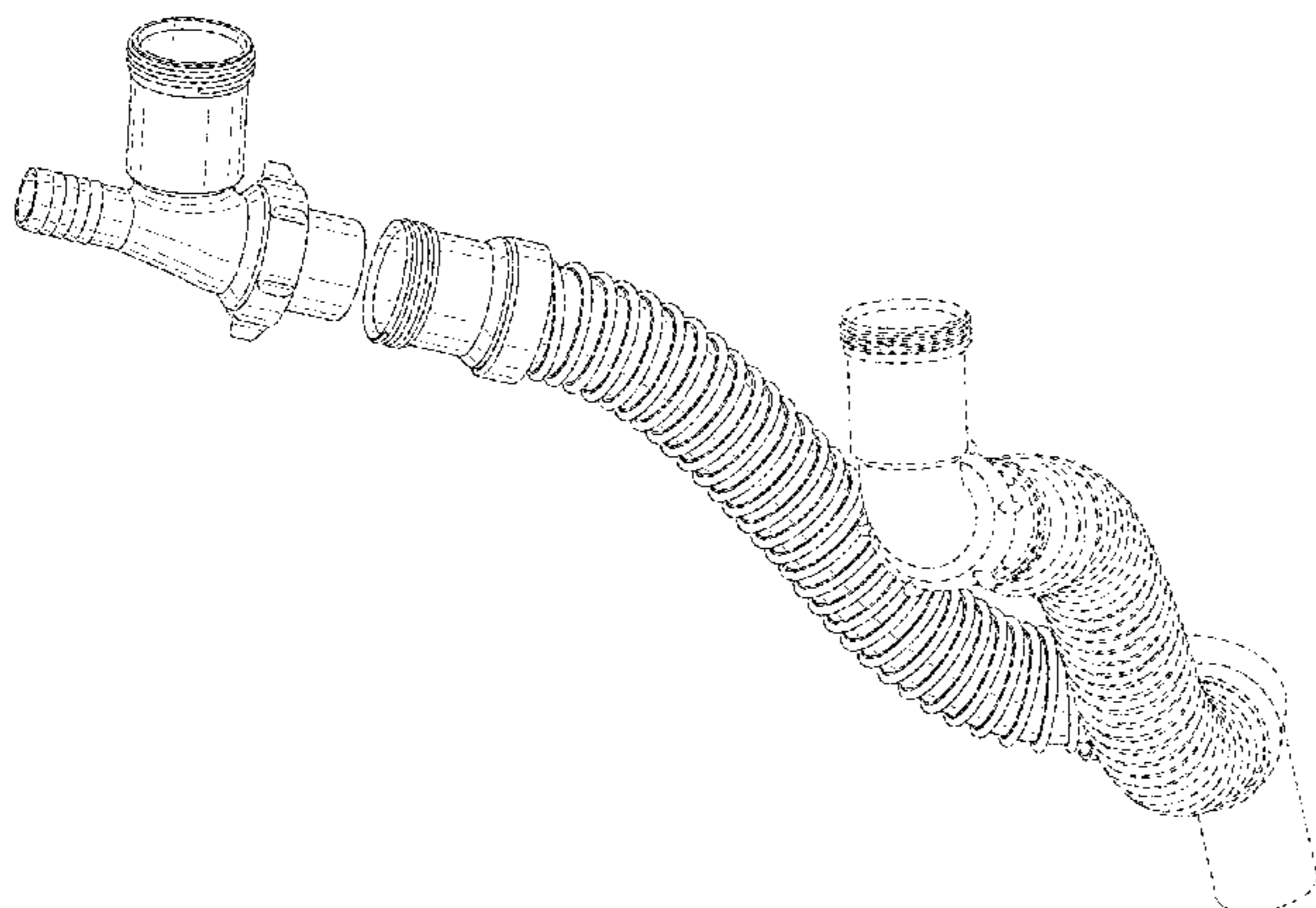

# US D753,270 S

Page 2

---

(56)

## References Cited

### U.S. PATENT DOCUMENTS

2010/0024120 A1*	2/2010	Coronado .....	E03C 1/20 4/679
2013/0334810 A1*	12/2013	Crary .....	F16L 25/0036 285/31
2014/0331404 A1*	11/2014	Sumner .....	E03C 1/28 4/679
2015/0108752 A1*	4/2015	Rickettson .....	F16L 33/221 285/243
2015/0136267 A1*	5/2015	Yu .....	E03C 1/284 138/109

\* cited by examiner

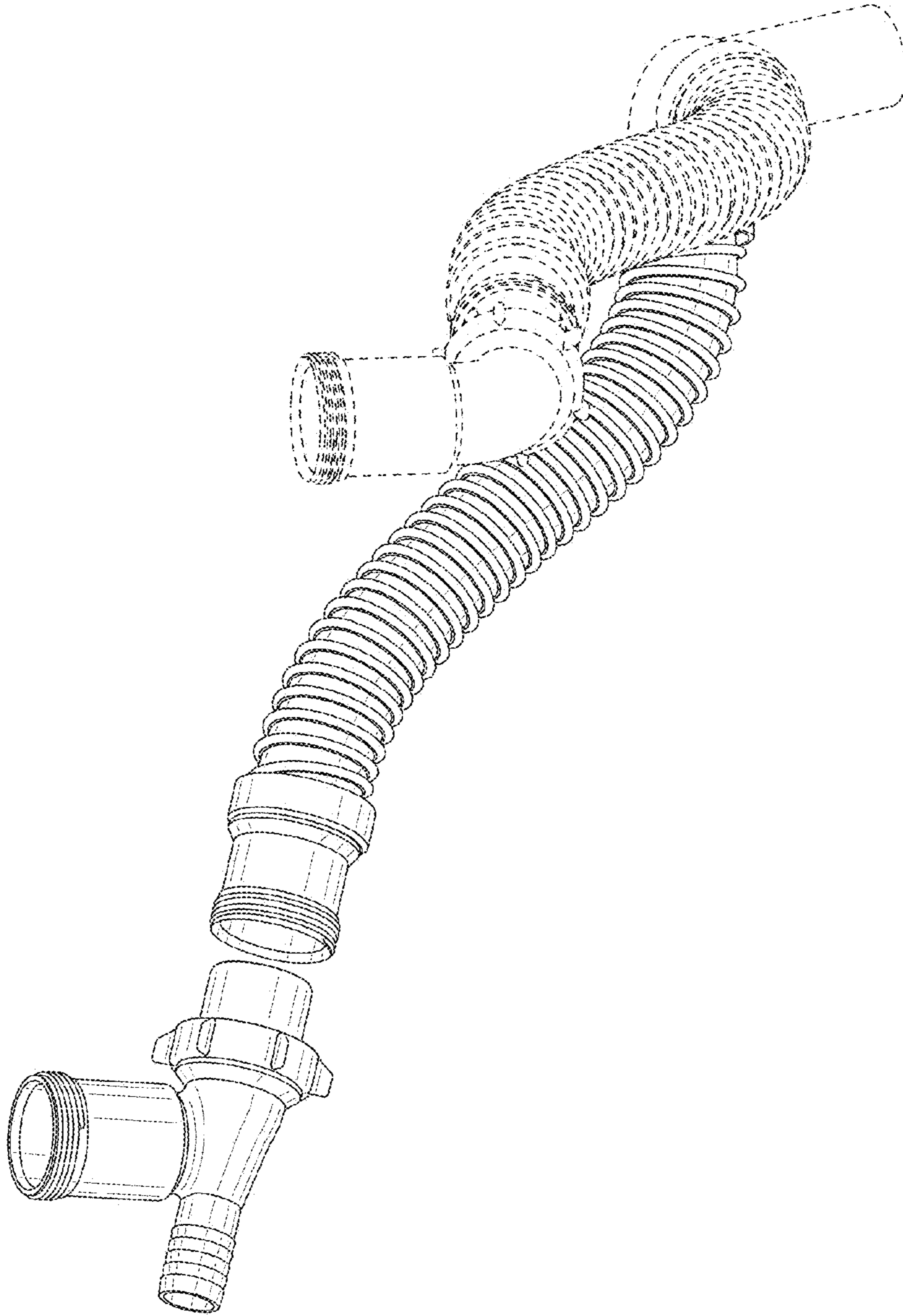

FIG. 1

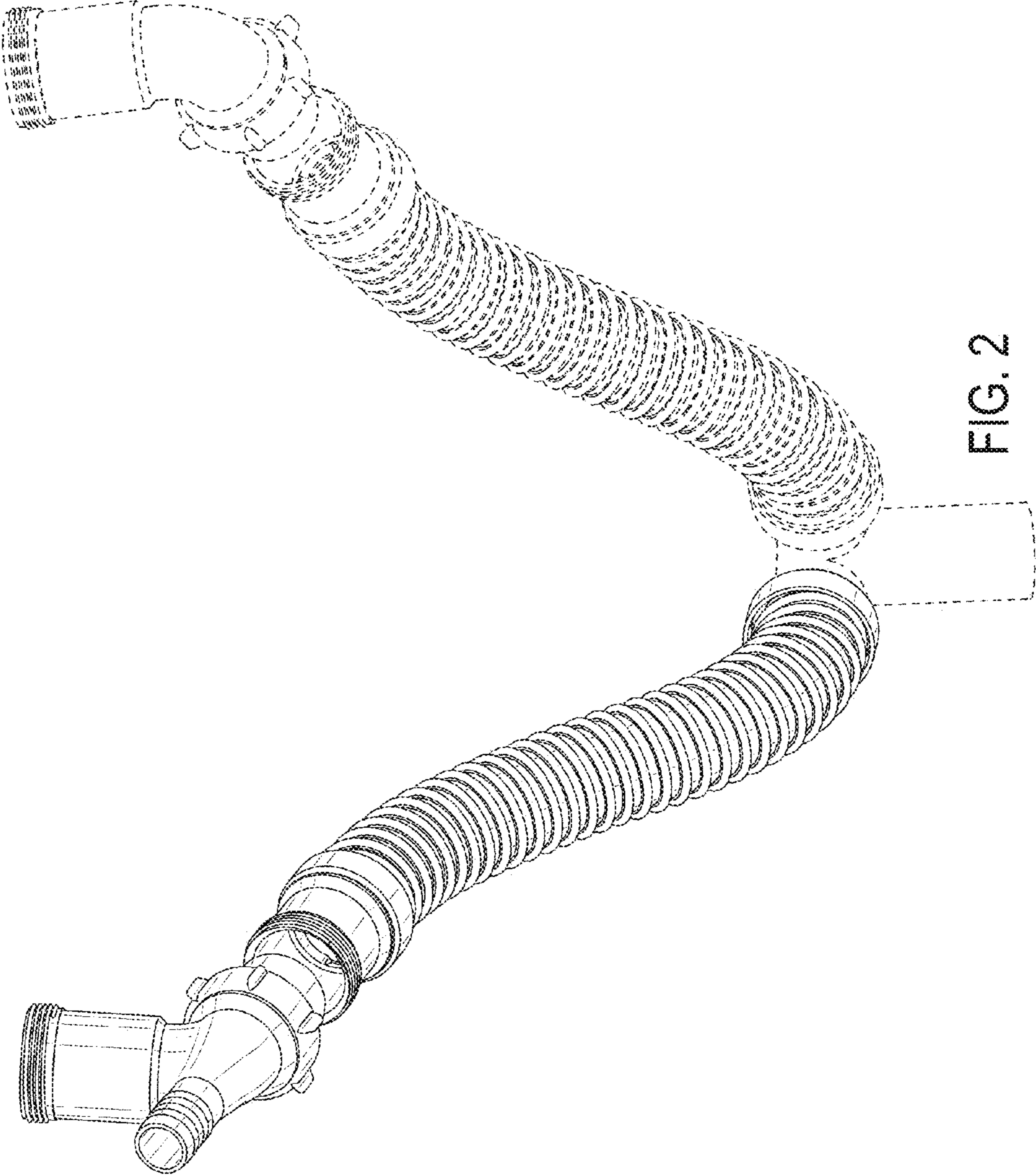

FIG. 2

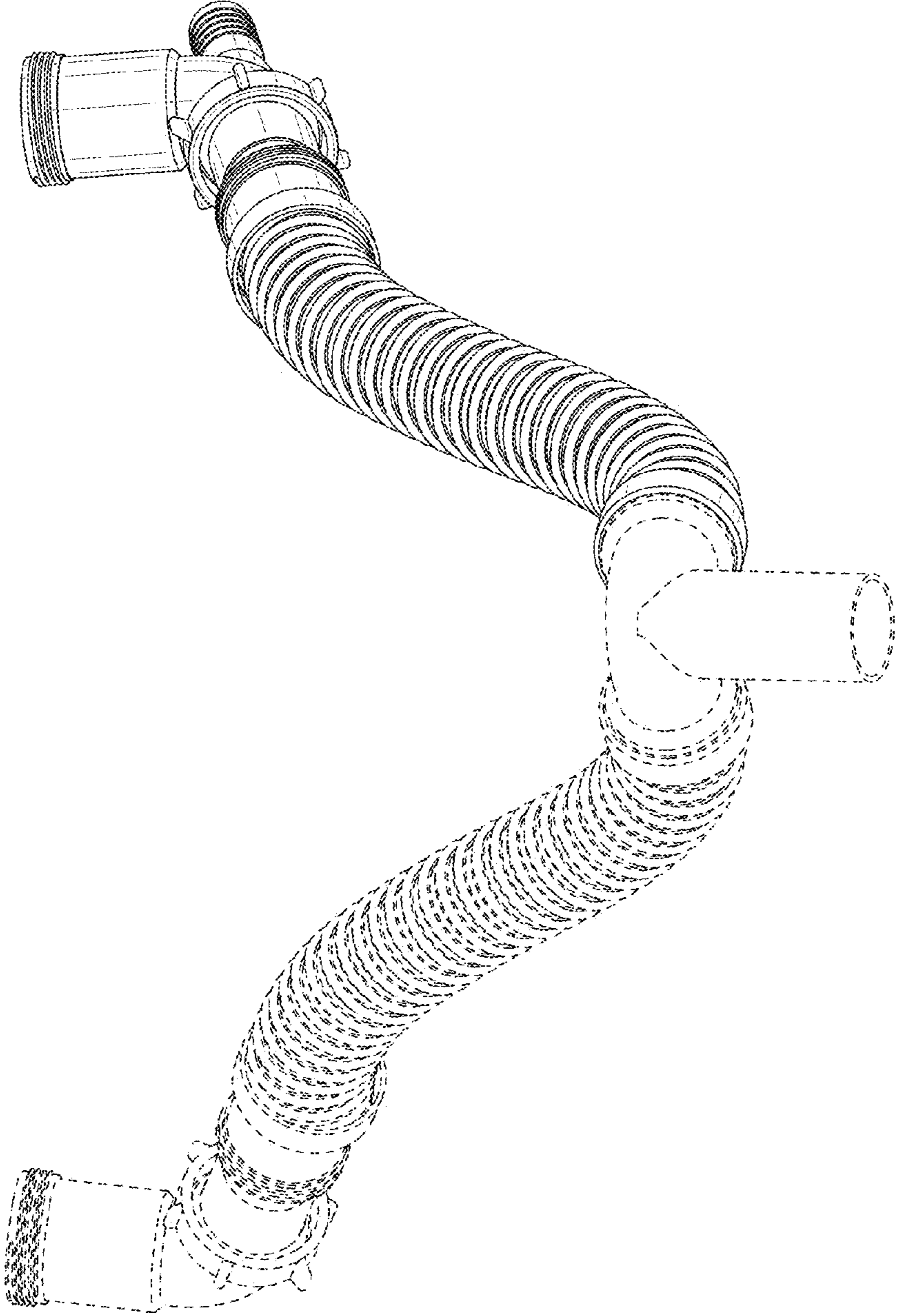

FIG. 3

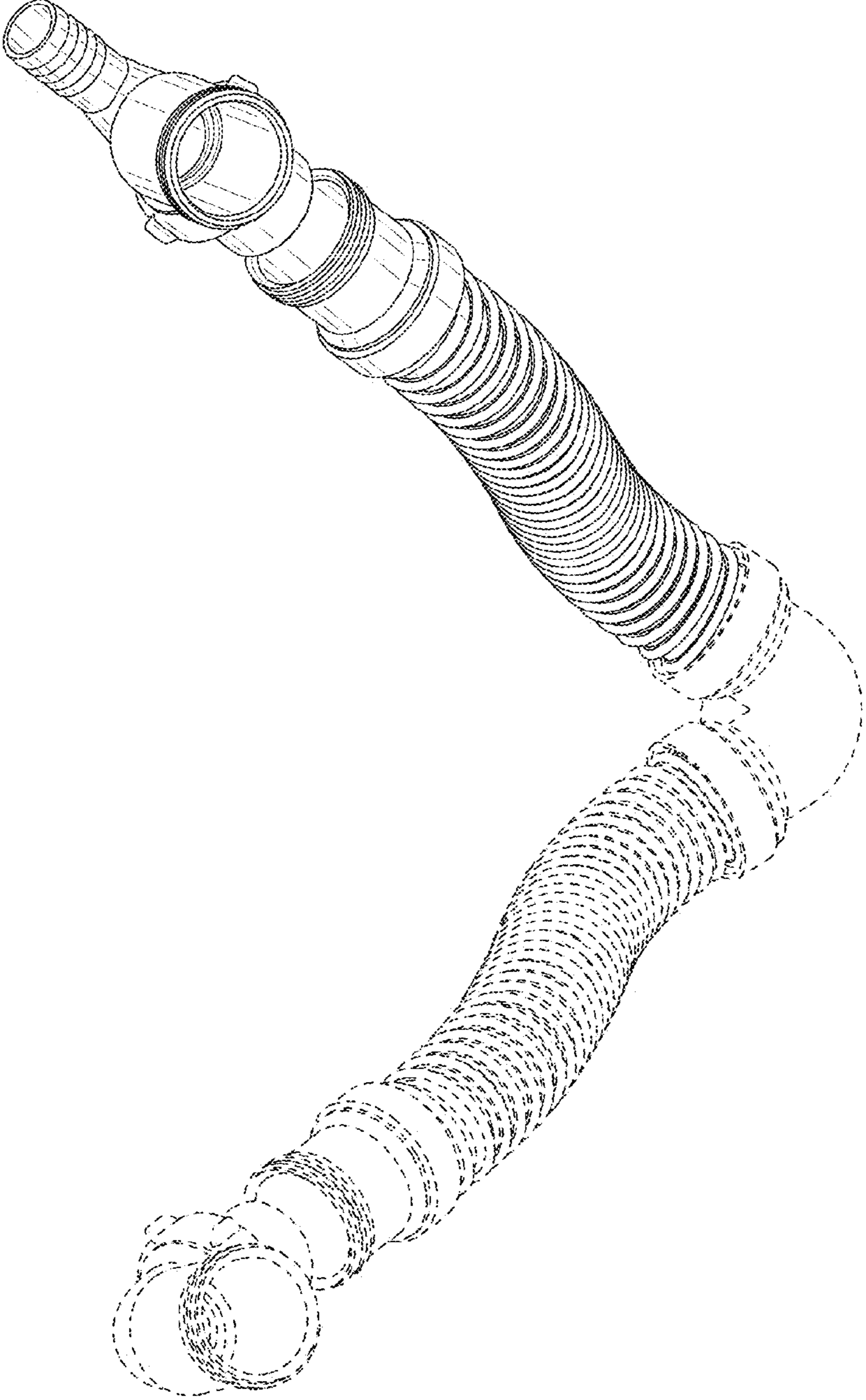

FIG. 4

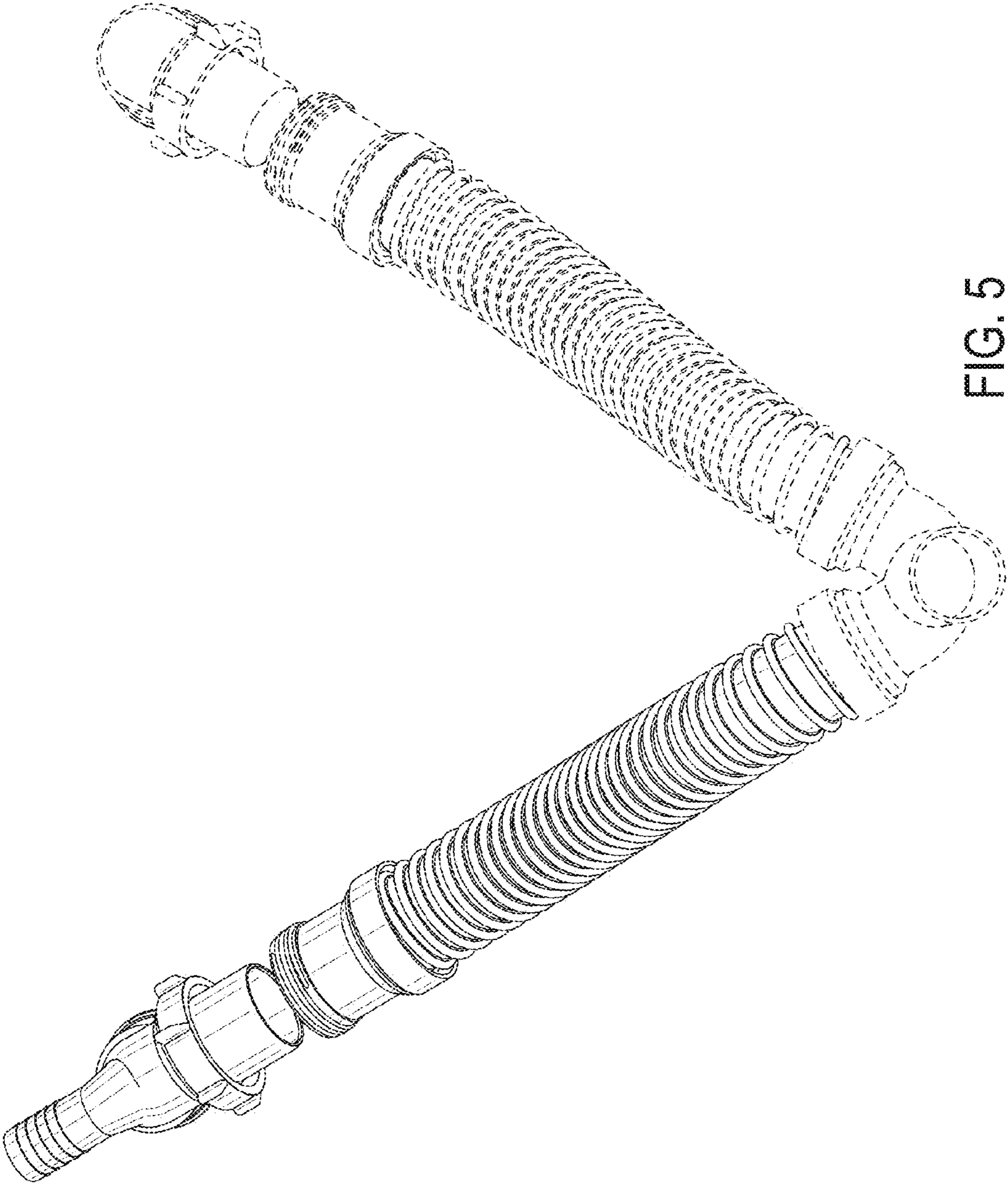

FIG. 5

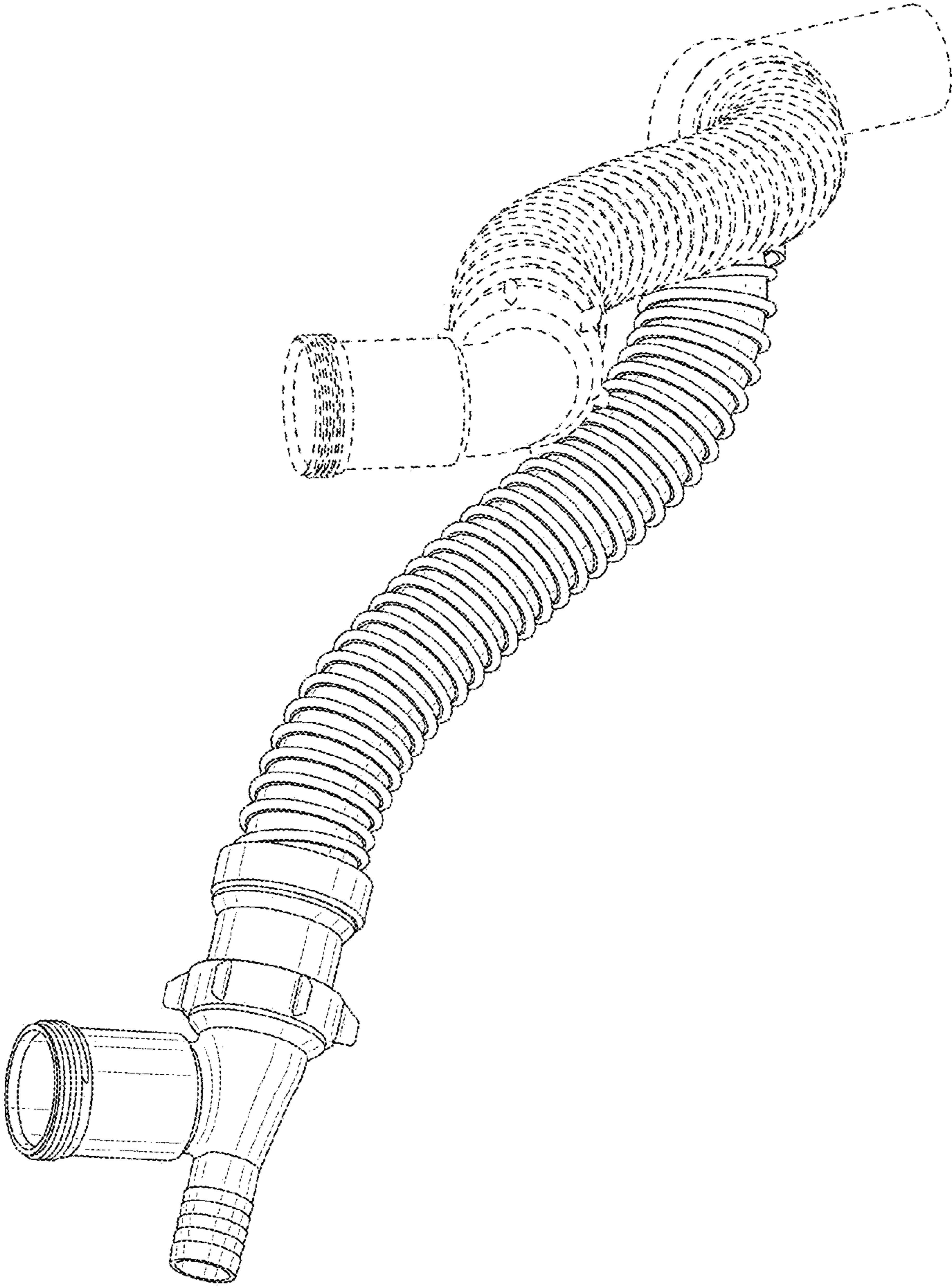

FIG. 6



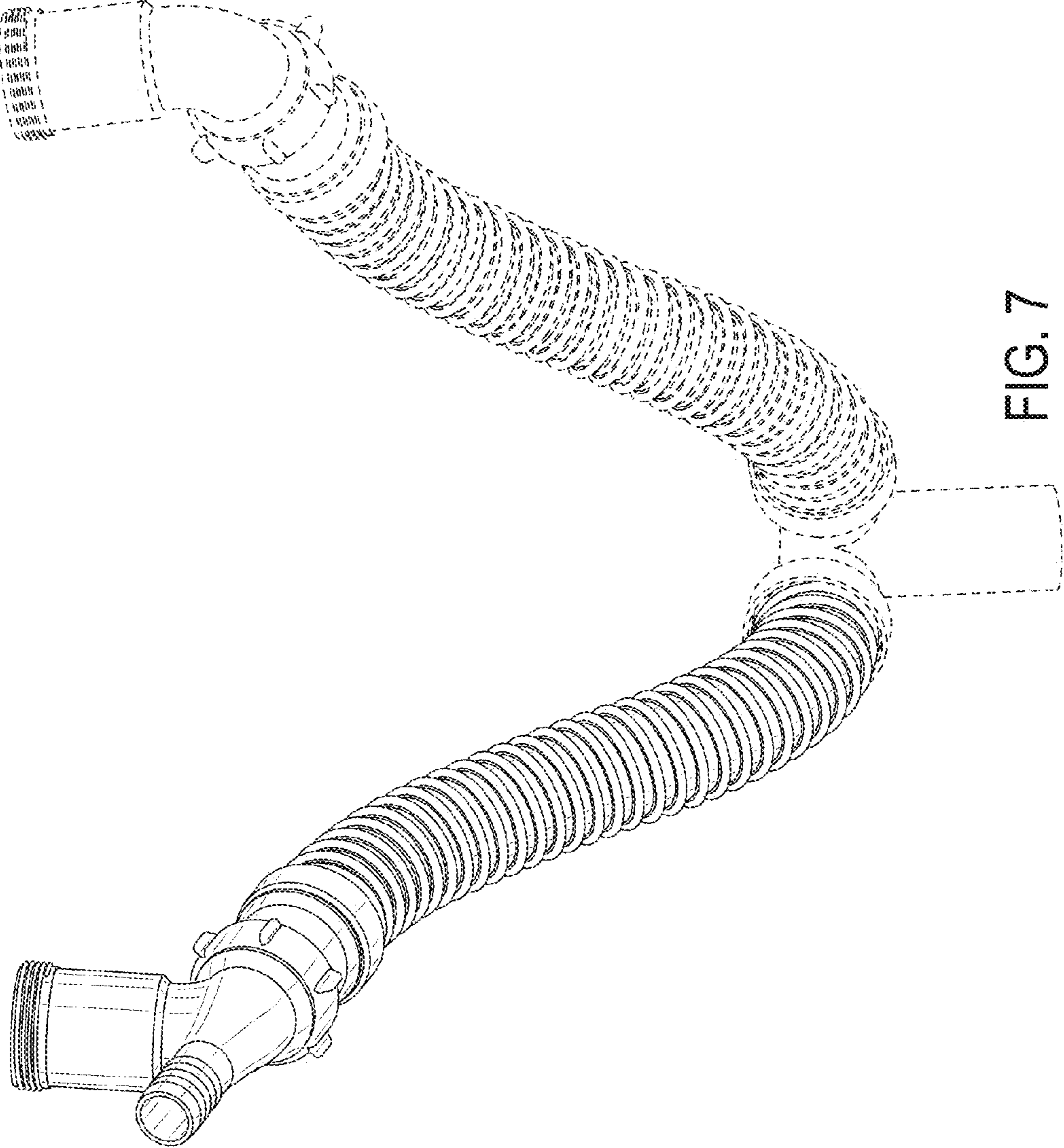

FIG. 7

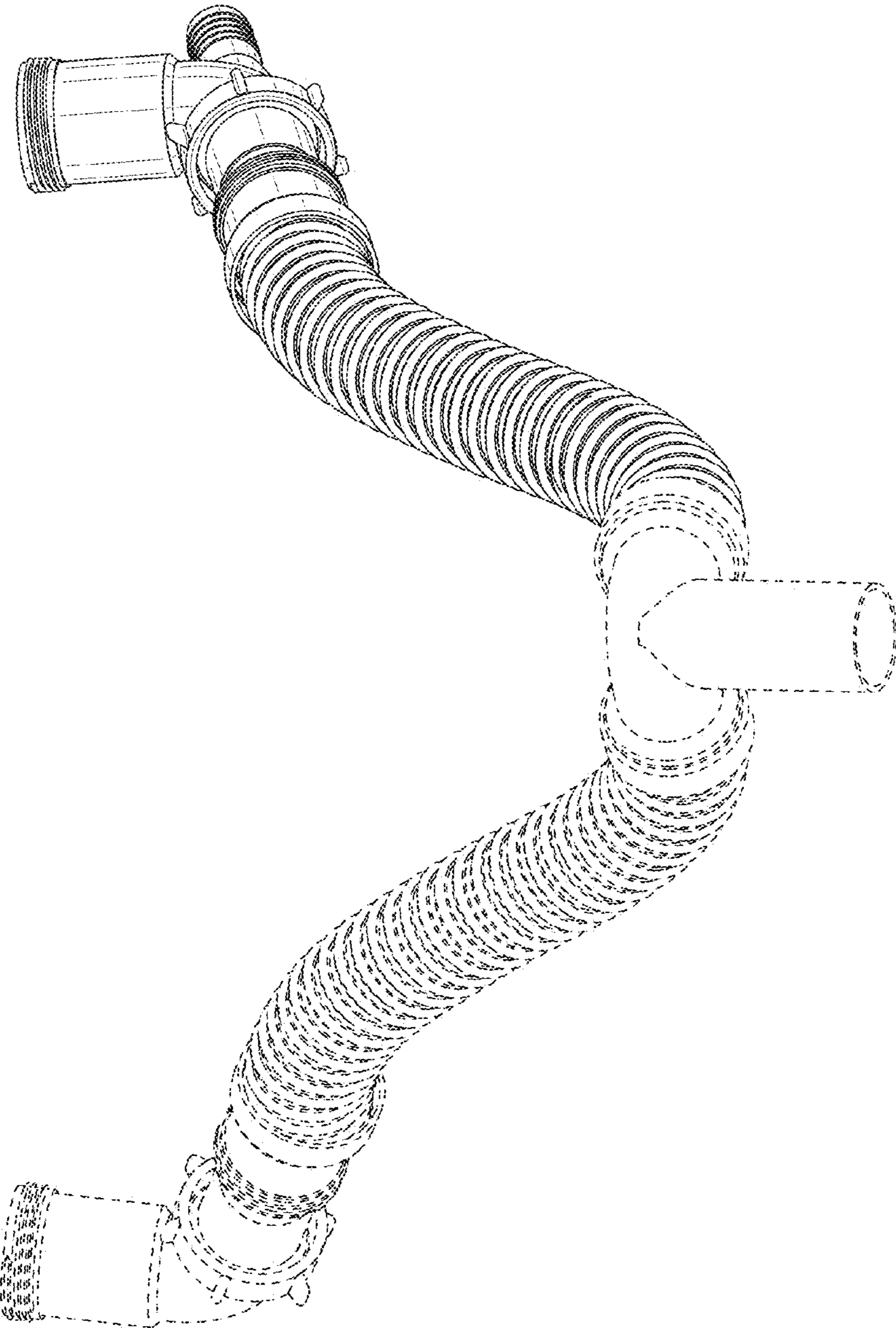

FIG. 8

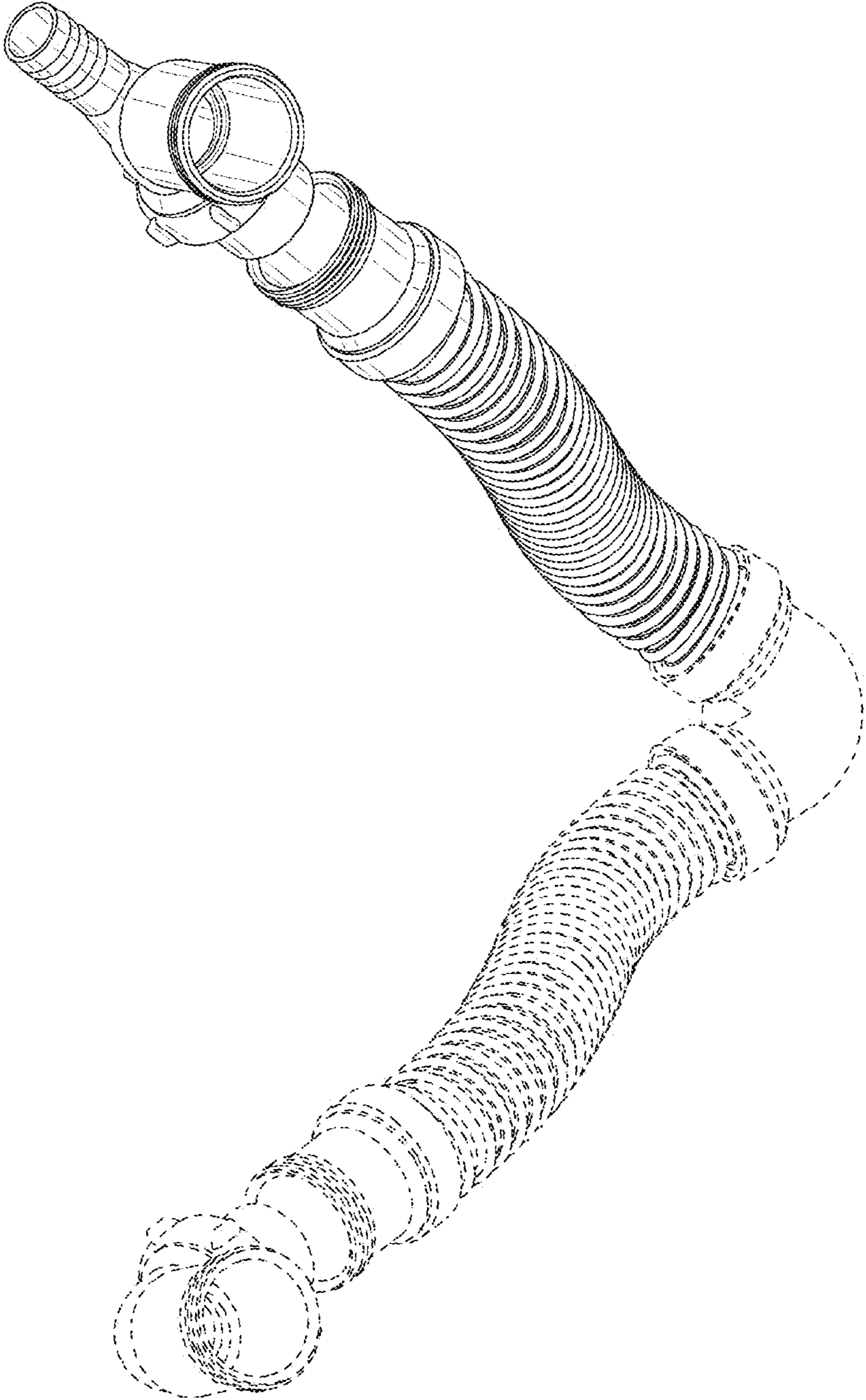

FIG. 9

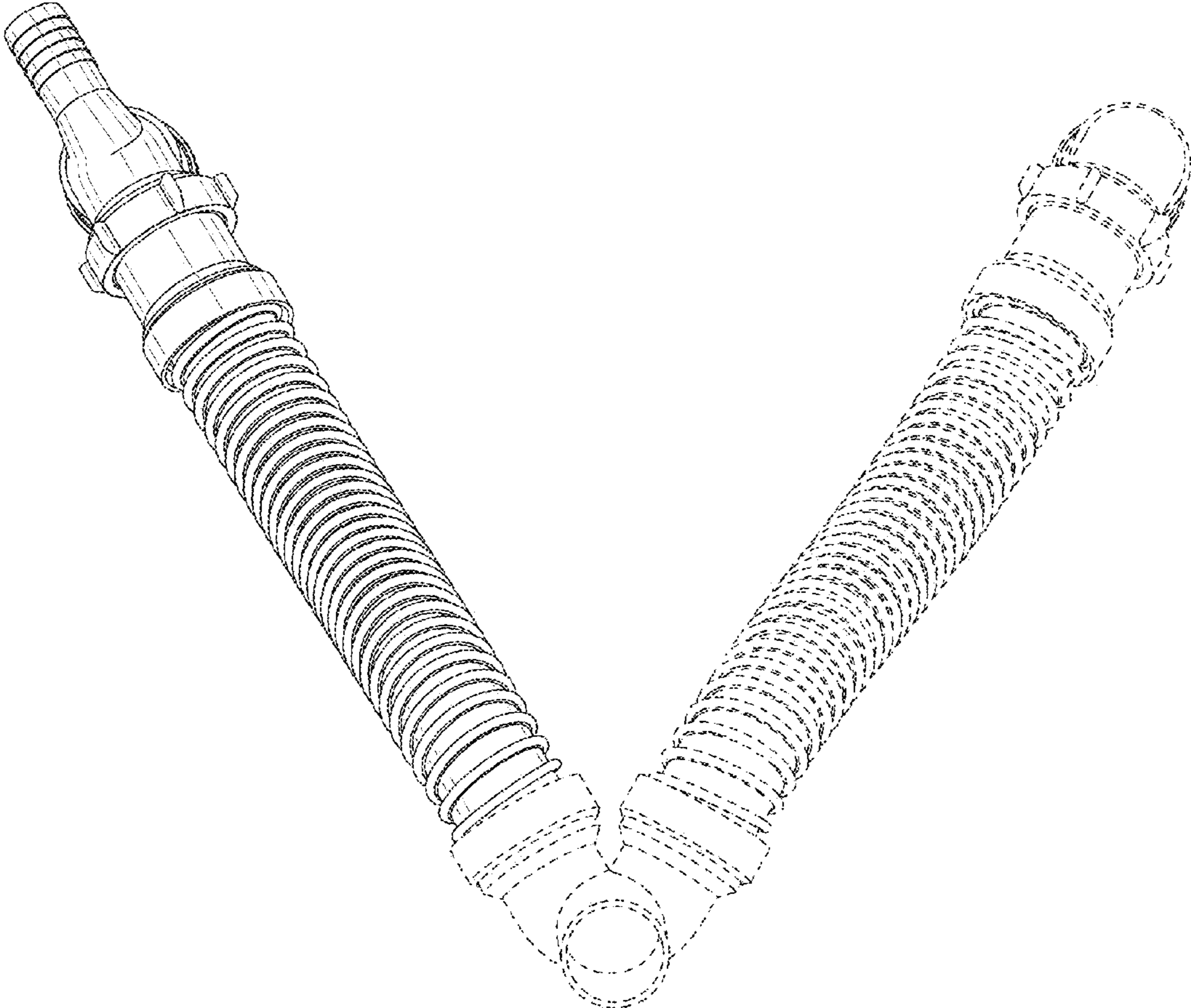

FIG. 10

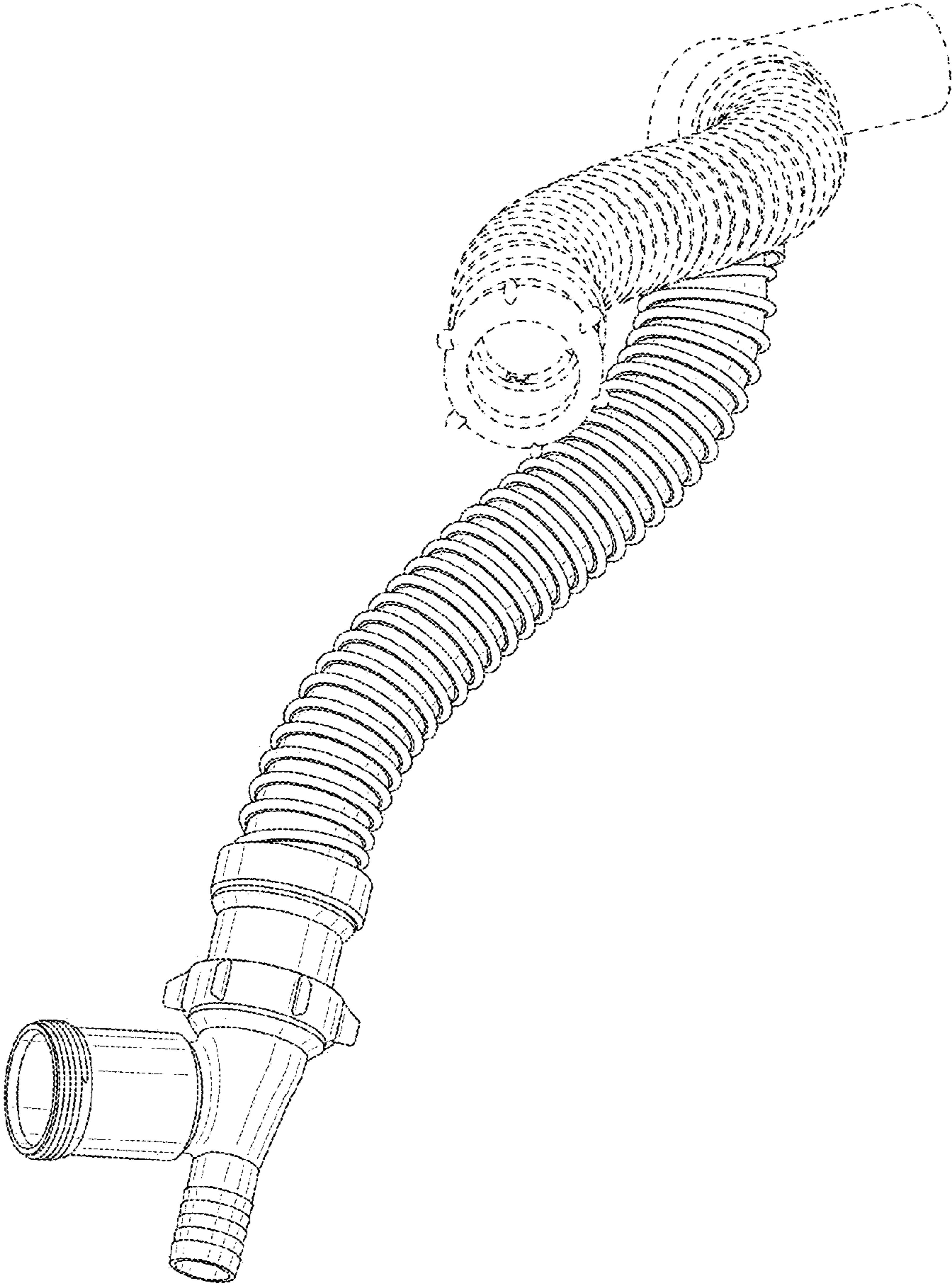

FIG. 11

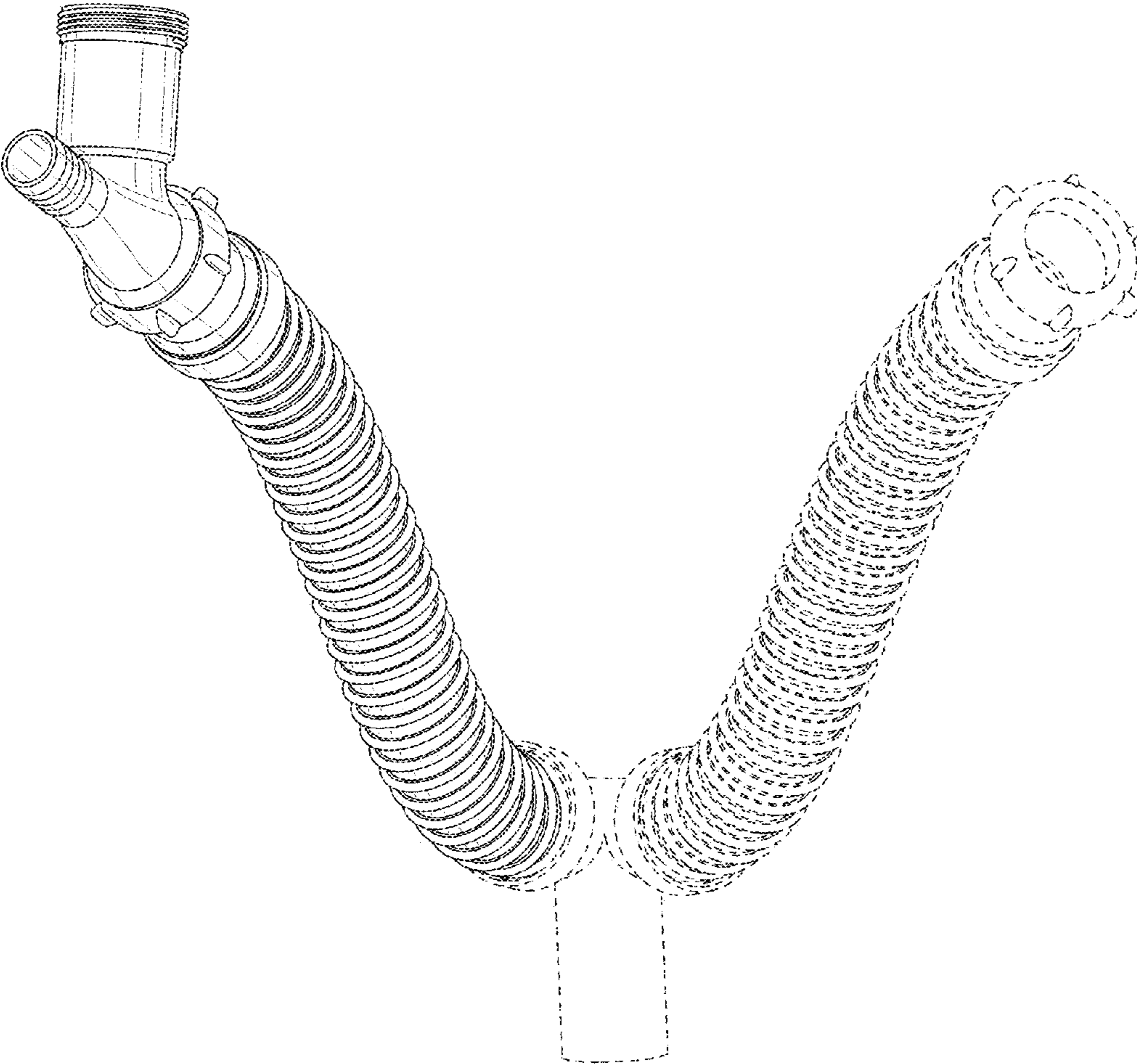

FIG. 12

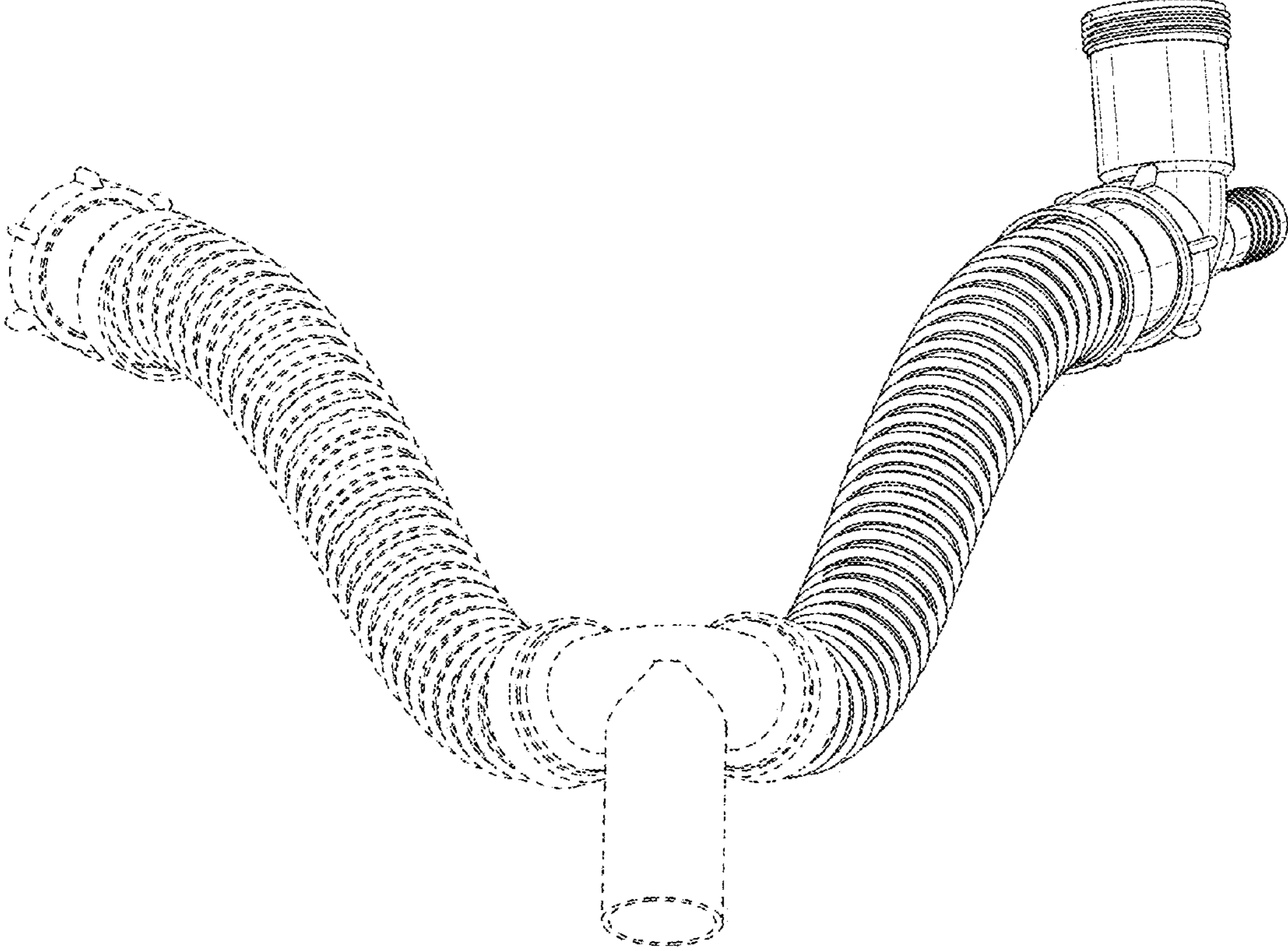

FIG. 13

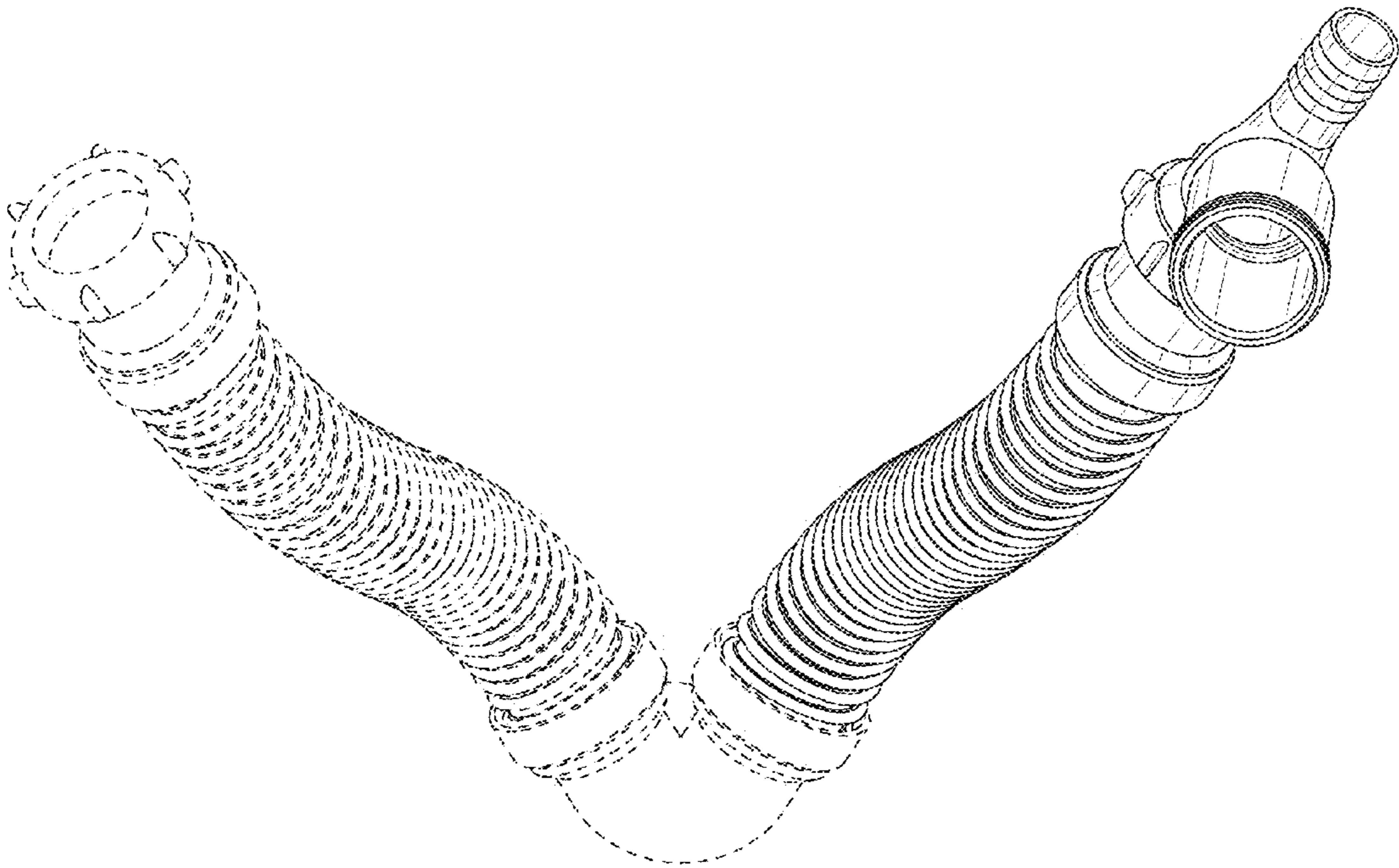

FIG. 14



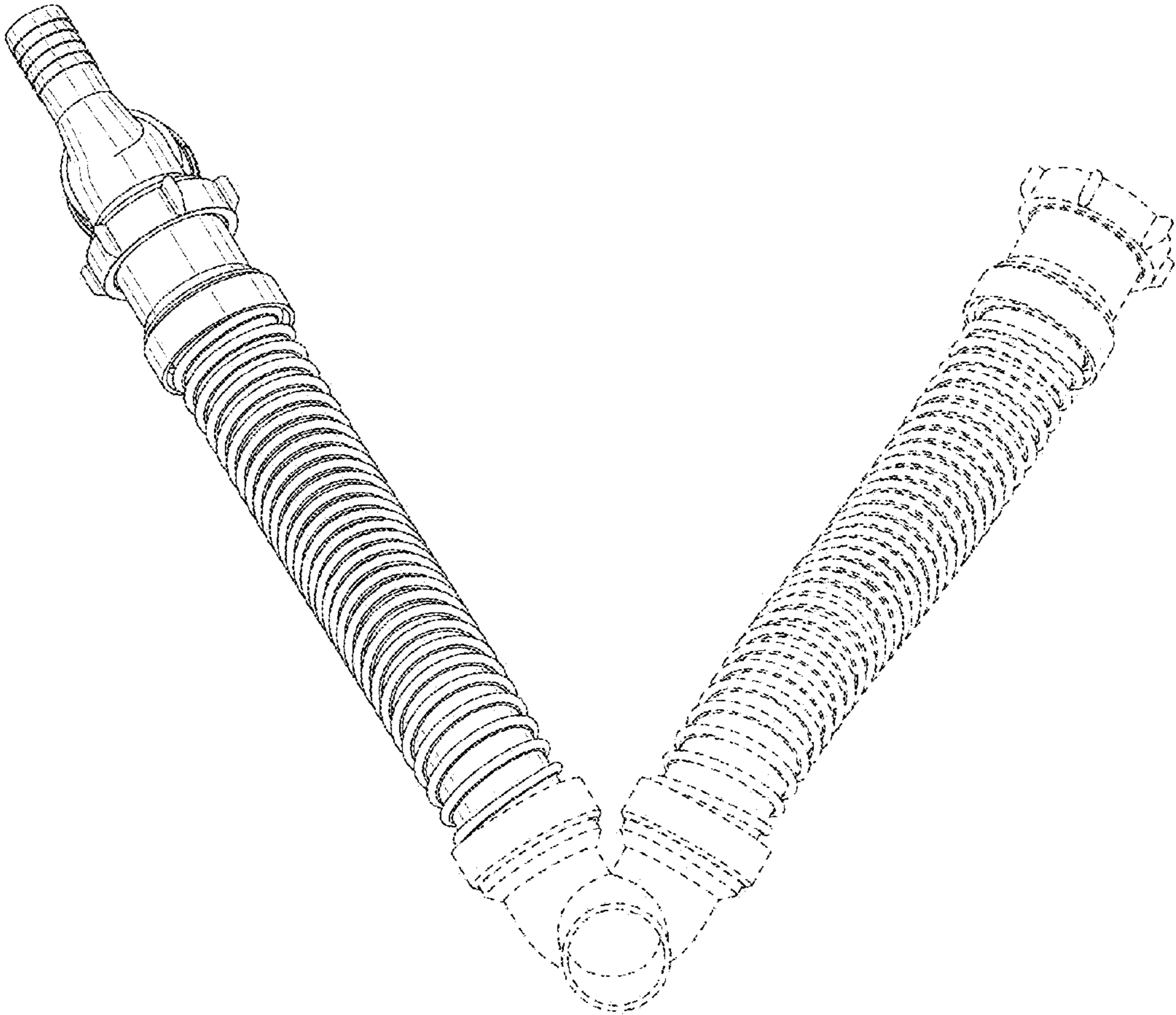

FIG. 15