



US00D753260S

(12) **United States Design Patent**  
**Solovov, Jr. et al.**

(10) **Patent No.:** **US D753,260 S**  
(45) **Date of Patent:** **\*\* Apr. 5, 2016**

(54) **CLIP FOR AMMUNITION**

(74) *Attorney, Agent, or Firm* — Polsinelli PC

(71) Applicant: **TULAMMO USA, INC.**, Round Rock, TX (US)

(72) Inventors: **Alexey Alexeevich Solovov, Jr.**, Tula (RU); **Maxim Nikolaevich Buyanov**, Tula (RU)

(57) **CLAIM**

The ornamental design for a clip for ammunition, as shown and described.

(73) Assignee: **Tulammo USA, Inc.**, Round Rock, TX (US)

**DESCRIPTION**

(\*\*) Term: **14 Years**

U.S. Design patent applications Ser. Nos. 29/503,546, 29/503,545, 29/503,548, and 29/503,535 filed on Sep. 26, 2014 are hereby incorporated by reference in their entireties.

(21) Appl. No.: **29/503,553**

(22) Filed: **Sep. 26, 2014**

FIG. 1 is a perspective view of the clip for ammunition;

(51) **LOC (10) Cl.** ..... **22-03**

FIG. 2 is a top view of the clip for ammunition;

(52) **U.S. Cl.**

FIG. 3 is a bottom view of the clip for ammunition;

USPC ..... **D22/116**; D9/414

FIG. 4 is a left side view of the clip for ammunition;

(58) **Field of Classification Search**

USPC ..... D22/108, 116; D9/414–415, 751, 423, D9/416, 432, 434, 600, 720; D19/90; D24/230

FIG. 5 is a right side view of the clip for ammunition;

CPC ..... B65D 85/20; B65D 5/5435; B65D 5/543; A24F 13/16; A47G 21/14

FIG. 6 is a front view of the clip for ammunition;

See application file for complete search history.

FIG. 7 is a rear view of the clip for ammunition;

FIG. 8 is a perspective view of the clip for ammunition holding ammunition;

FIG. 9 is a perspective view of the second embodiment of the clip for ammunition;

(56) **References Cited**

**U.S. PATENT DOCUMENTS**

|           |     |         |            |       |                        |
|-----------|-----|---------|------------|-------|------------------------|
| 160,420   | A * | 3/1875  | Goss       | ..... | A45F 5/02<br>224/247   |
| 549,710   | A * | 11/1895 | Evans      | ..... | A45F 5/02<br>224/247   |
| 2,477,806 | A * | 8/1949  | Isaacson   | ..... | F41A 9/83<br>224/247   |
| D363,525  | S * | 10/1995 | Montefusco | ..... | D22/108                |
| 5,813,157 | A * | 9/1998  | Scott      | ..... | F41C 23/22<br>42/71.01 |
| 5,924,613 | A * | 7/1999  | Johnson    | ..... | A45F 5/02<br>2/94      |
| D463,117  | S * | 9/2002  | Carter     | ..... | D3/221                 |

(Continued)

FIG. 10 is a top view of the second embodiment of the clip for ammunition holding ammunition;

FIG. 11 is a bottom view of the second embodiment of the clip for ammunition;

FIG. 12 is a left view of the second embodiment of the clip for ammunition;

FIG. 13 is a right view of the second embodiment of the clip for ammunition;

FIG. 14 is a front view of the second embodiment of the clip for ammunition holding ammunition; and,

FIG. 15 is a rear view of the second embodiment of the clip for ammunition.

The broken lines showing in the figures are included for the purpose of illustrating portions of the figures that form no part of the claimed design.

*Primary Examiner* — Michael A Pratt

**1 Claim, 4 Drawing Sheets**

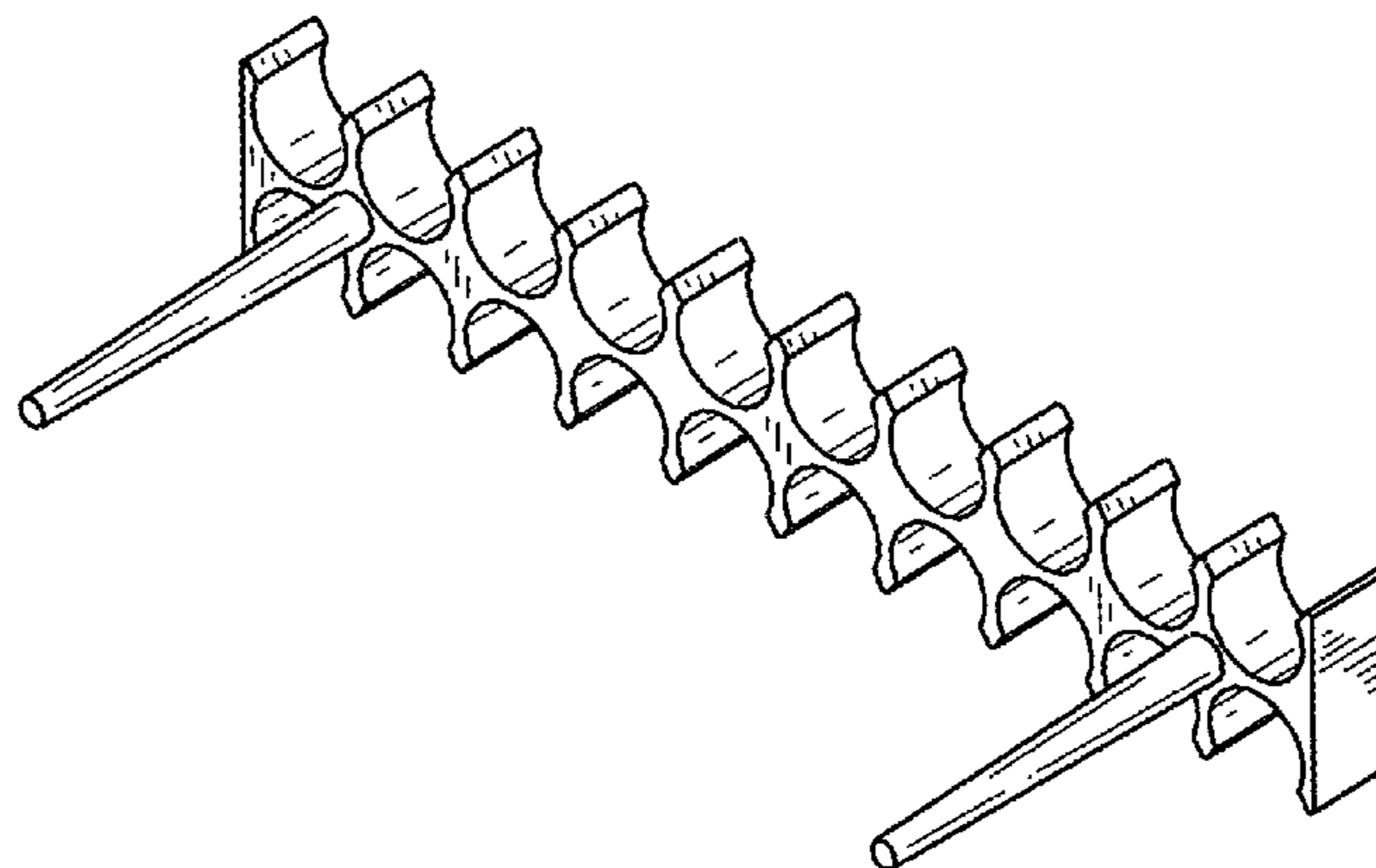

(56)

**References Cited**

U.S. PATENT DOCUMENTS

|              |      |         |             |       |                      |
|--------------|------|---------|-------------|-------|----------------------|
| 8,479,430    | B1 * | 7/2013  | Masten      | ..... | F42B 39/02<br>42/72  |
| 8,931,633    | B2 * | 1/2015  | Martin, III | ..... | F41A 9/85<br>206/3   |
| 2012/0222343 | A1 * | 9/2012  | Kim         | ..... | F41A 9/83<br>42/88   |
| 2012/0285066 | A1 * | 11/2012 | Chvala      | ..... | F42B 39/28<br>42/90  |
| 2013/0074392 | A1 * | 3/2013  | McCaffery   | ..... | F42B 39/02<br>42/90  |
| 2013/0334073 | A1 * | 12/2013 | Frye        | ..... | F42B 39/00<br>206/38 |
| 2014/0190058 | A1 * | 7/2014  | Ballard     | ..... | F42B 39/02<br>42/90  |
| 2014/0317985 | A1 * | 10/2014 | Cauley, Jr. | ..... | F41A 9/83<br>42/87   |
| 2015/0247691 | A1 * | 9/2015  | Solomon     | ..... | F42B 39/02<br>42/87  |

\* cited by examiner

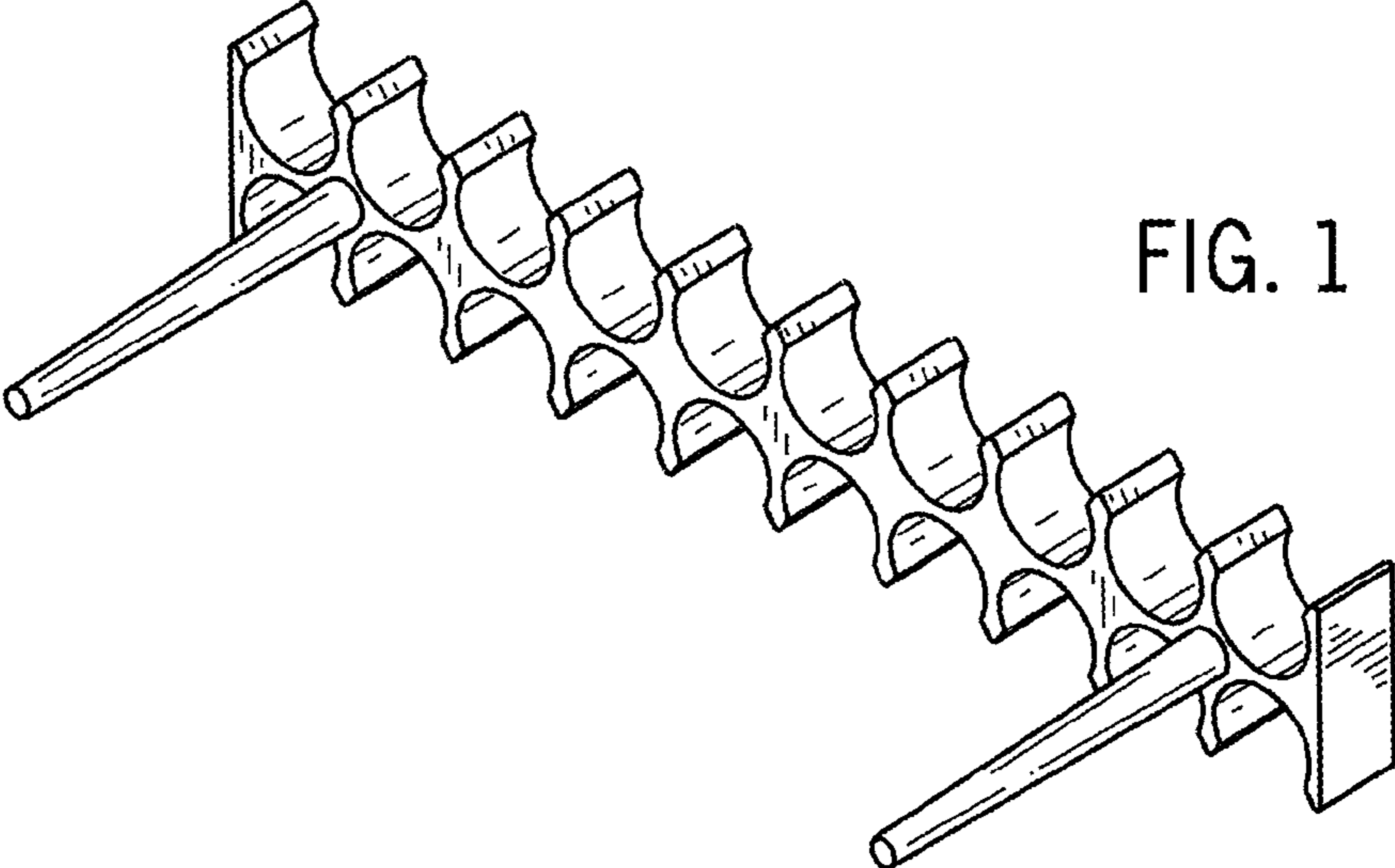

FIG. 1

FIG. 2

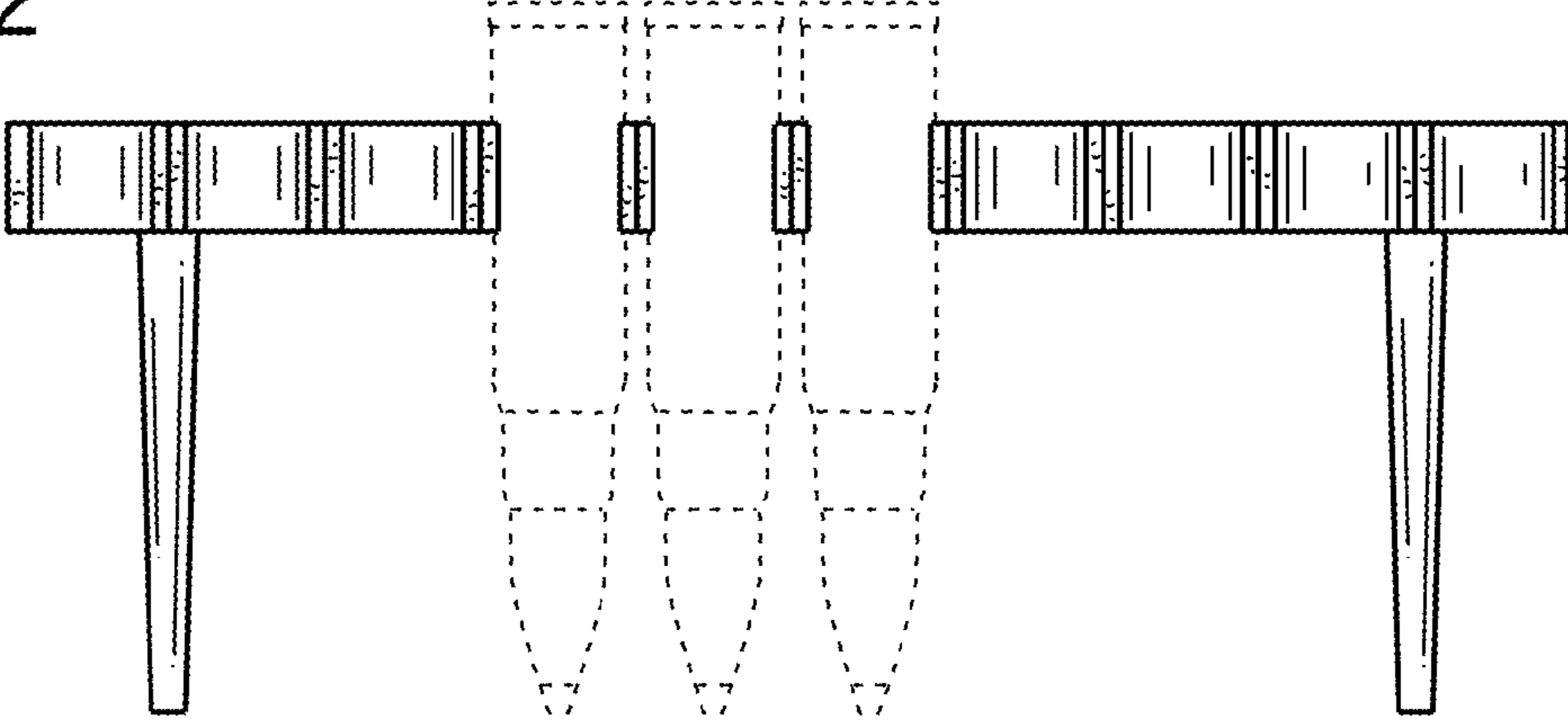
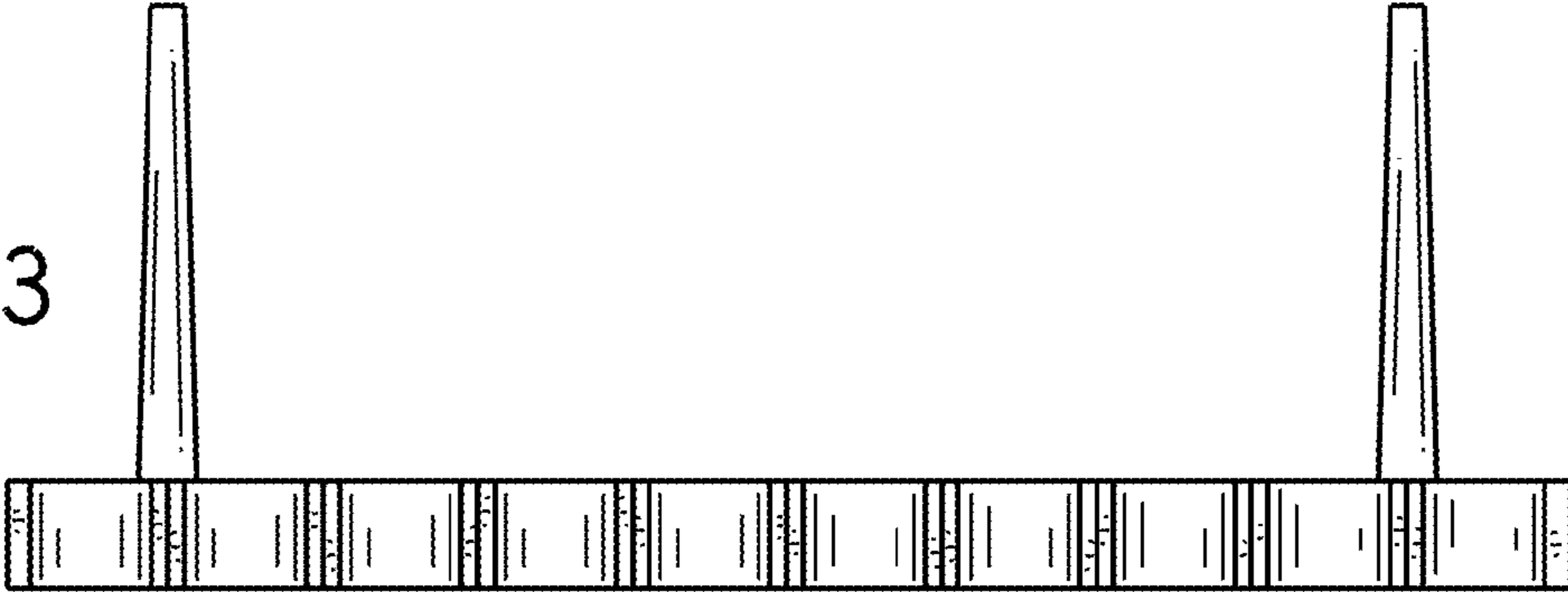

FIG. 3



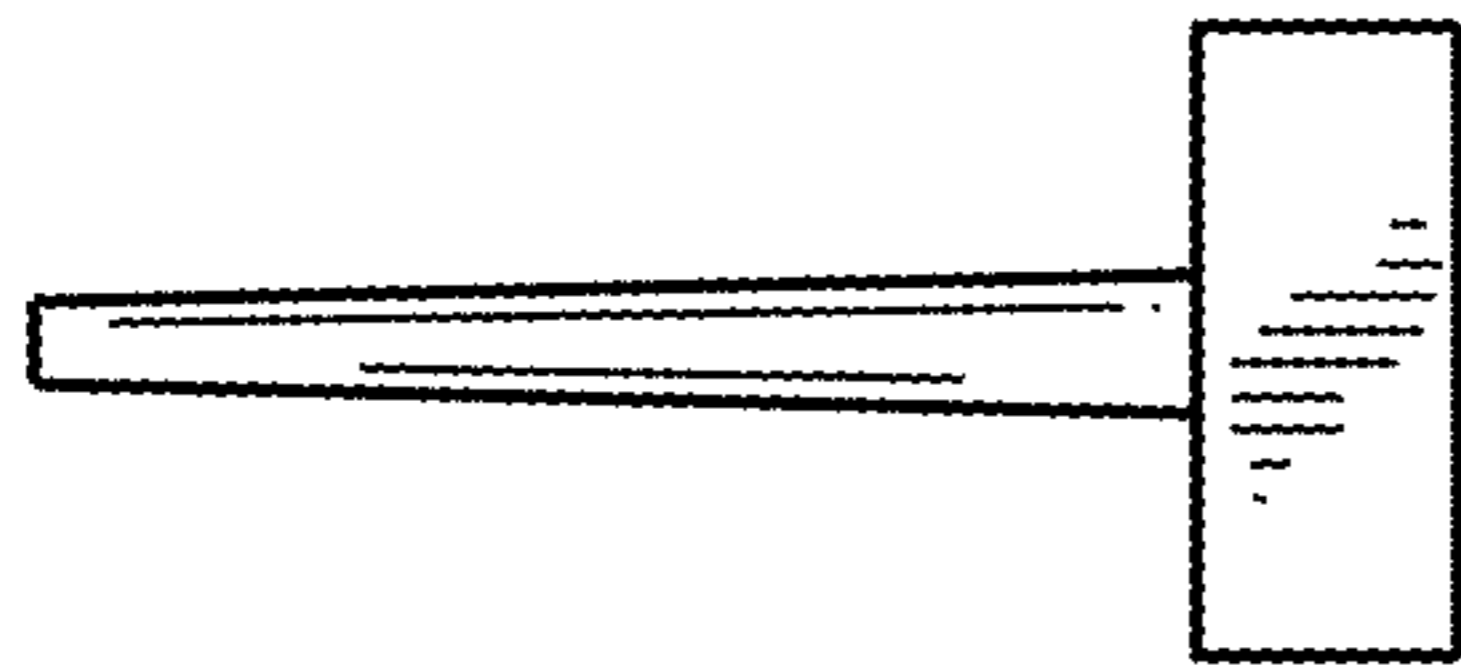

FIG. 4

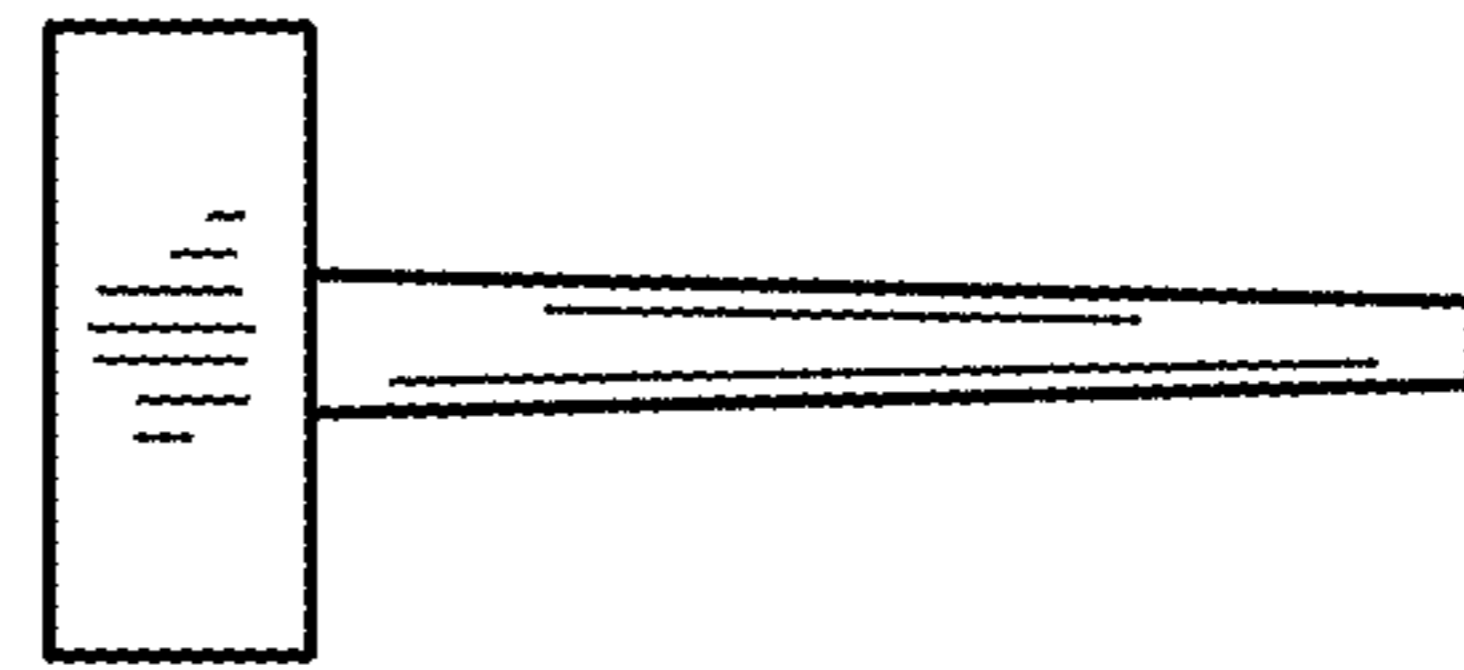

FIG. 5

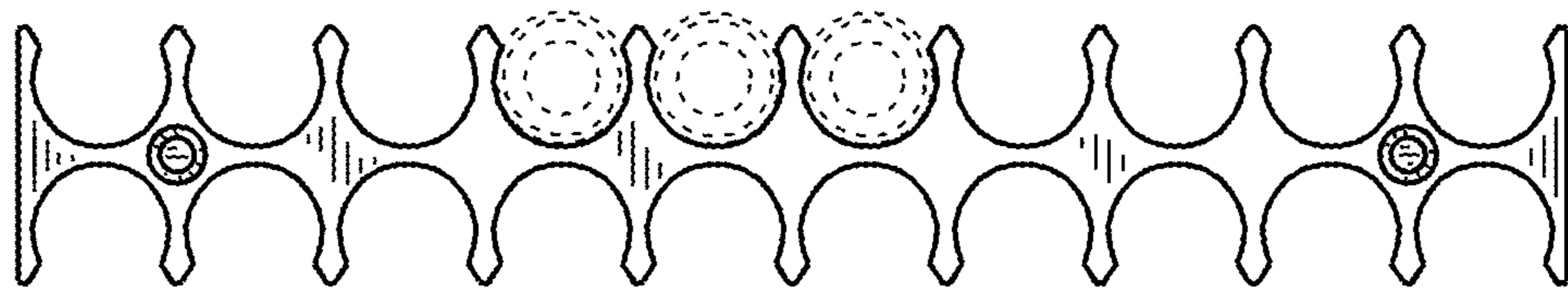

FIG. 6

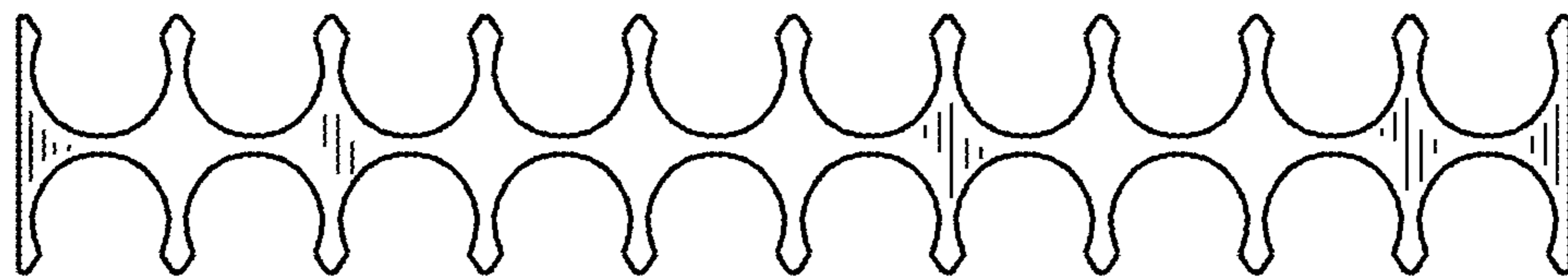

FIG. 7

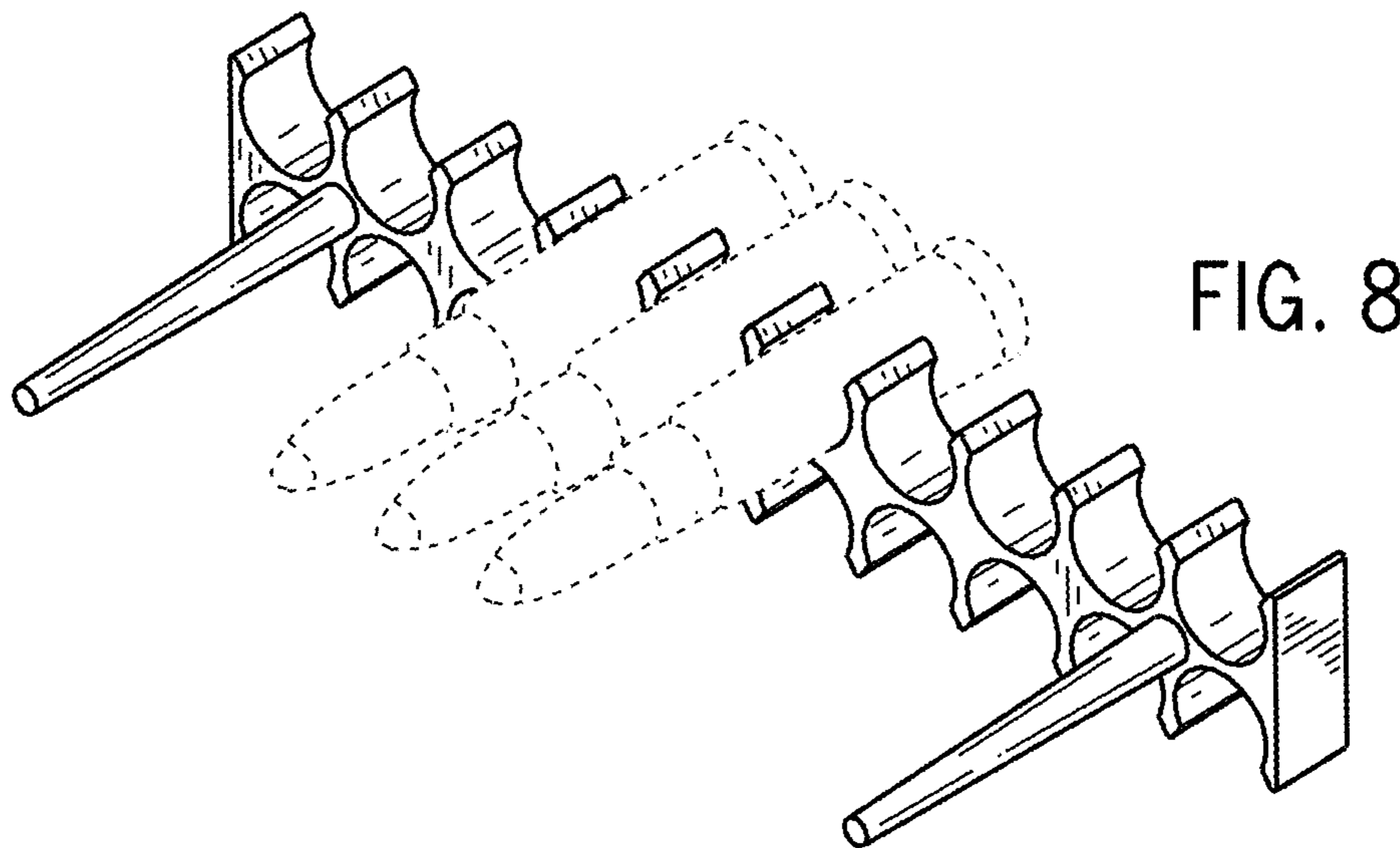

FIG. 8

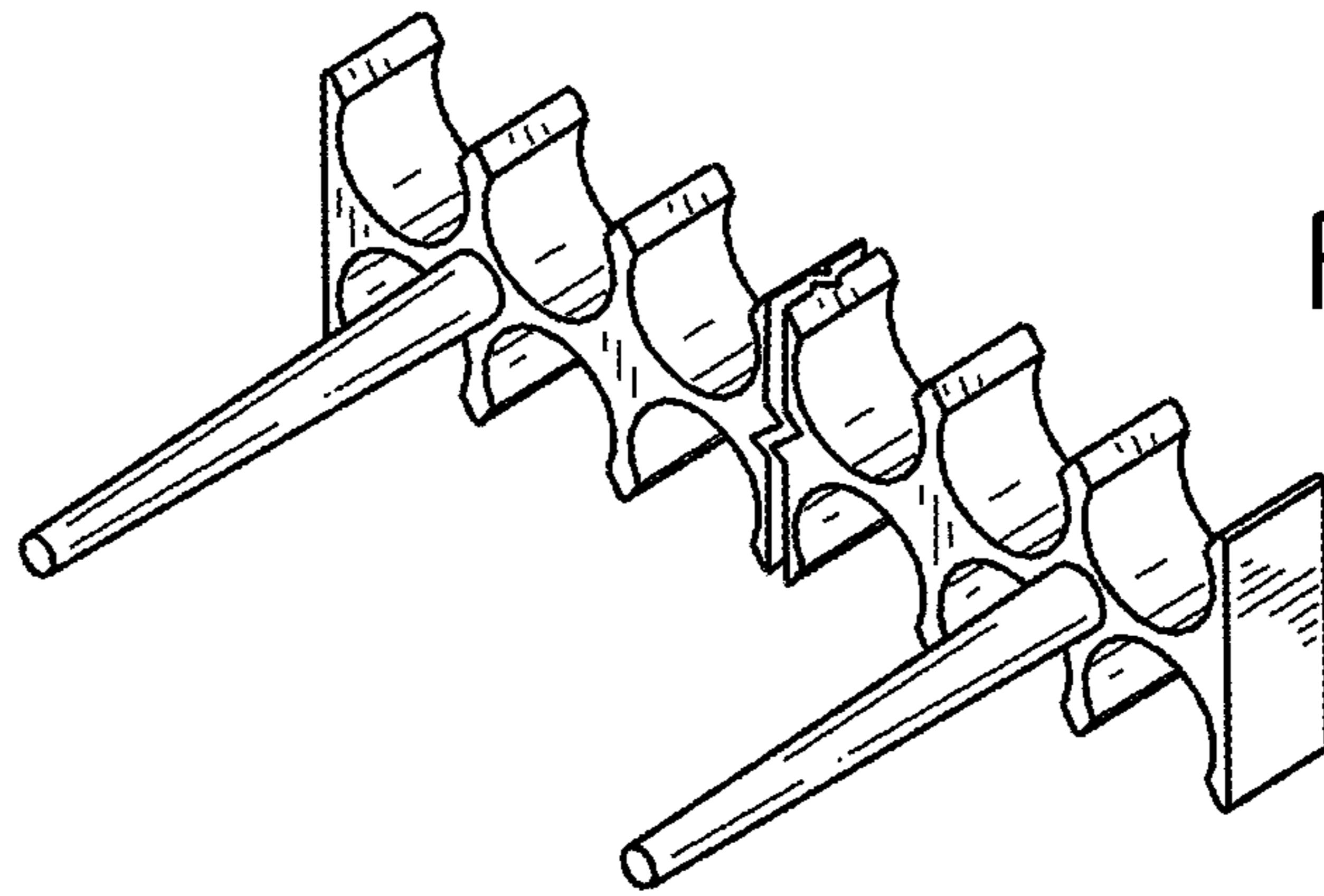

FIG. 9

FIG. 10

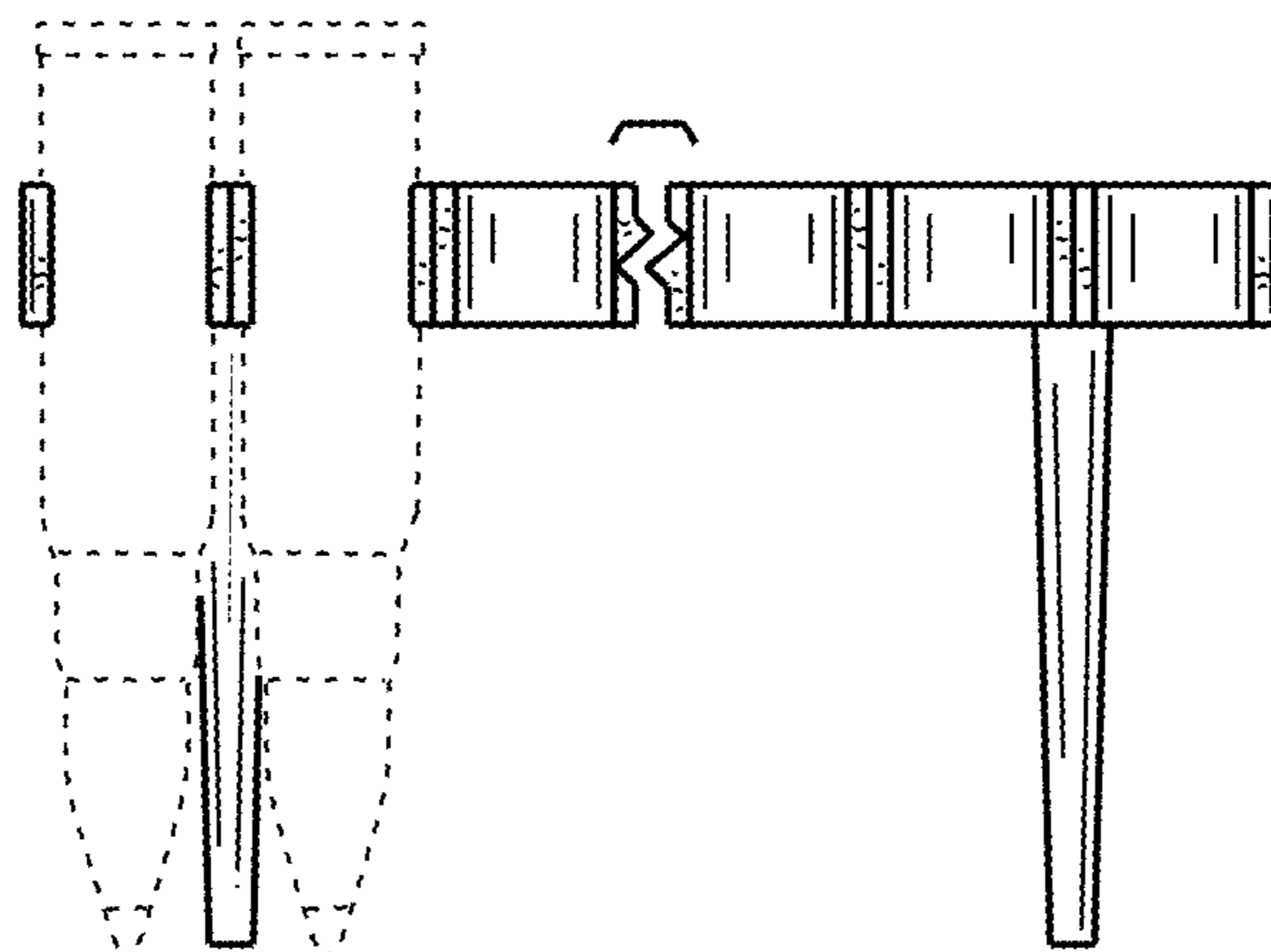
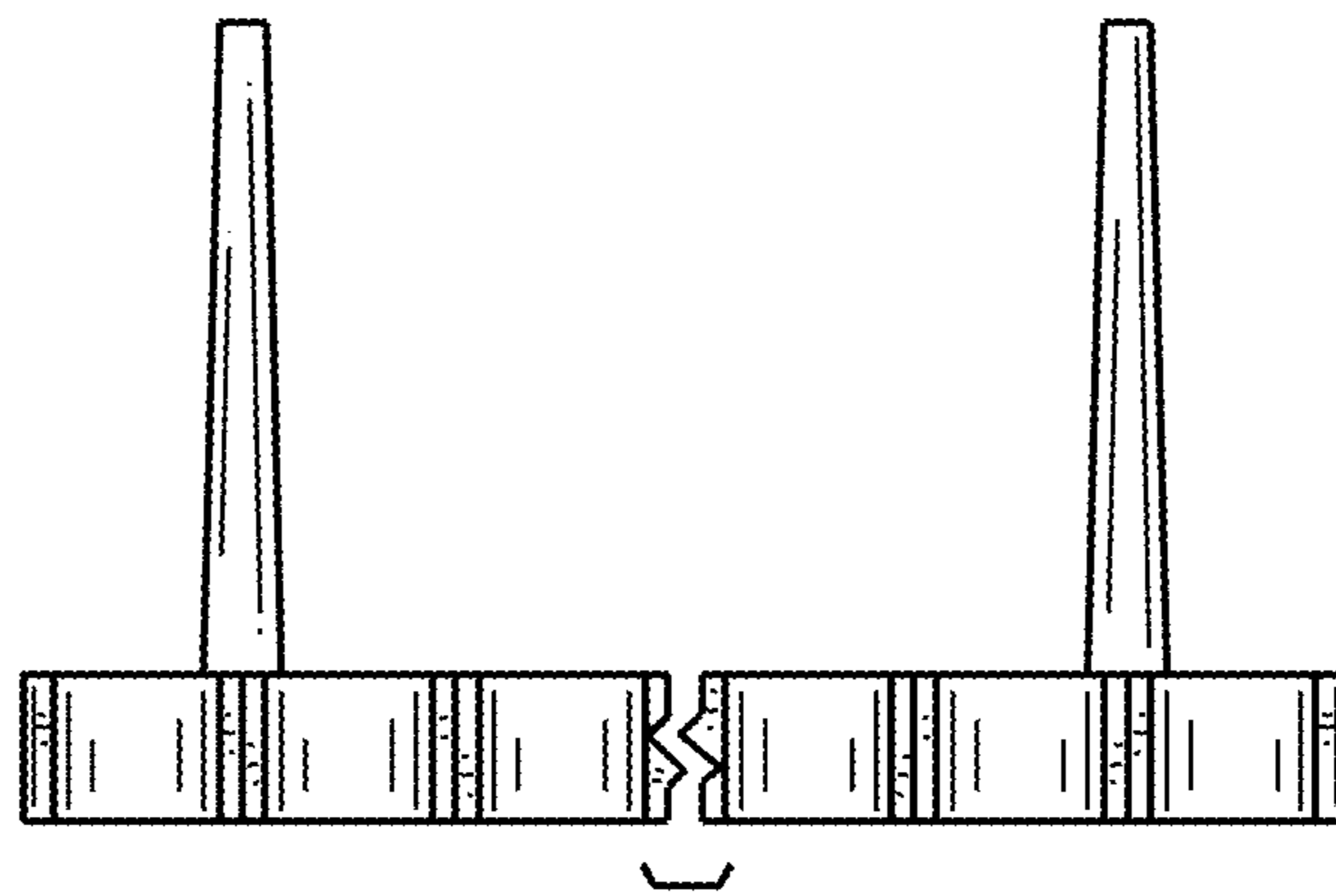

FIG. 11



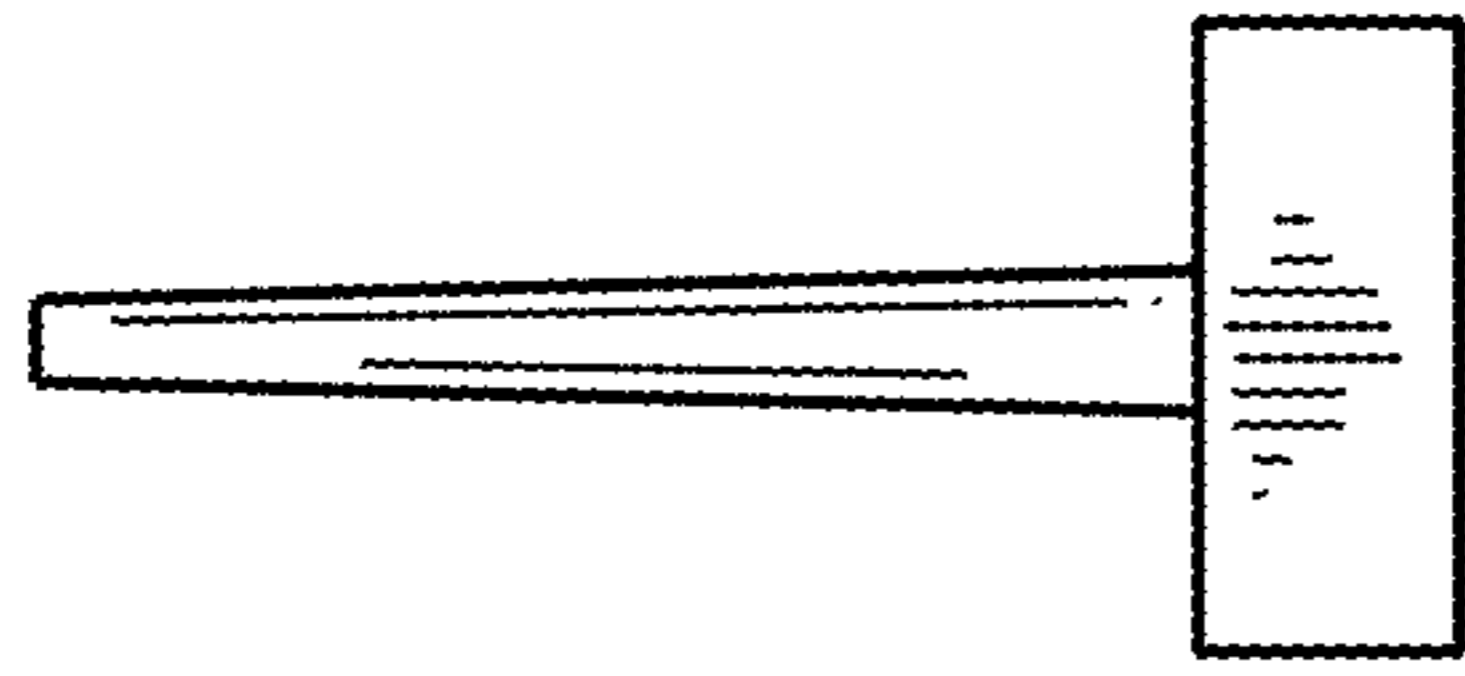

FIG. 12

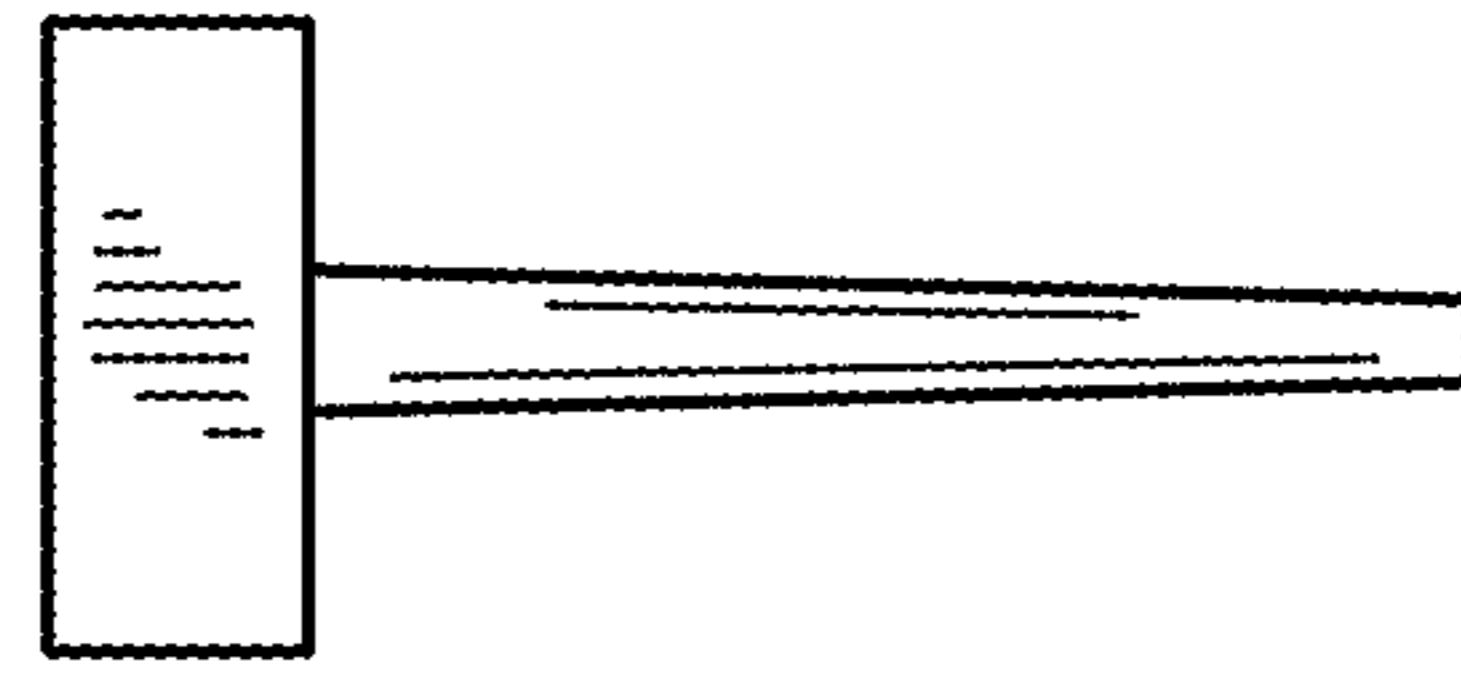

FIG. 13

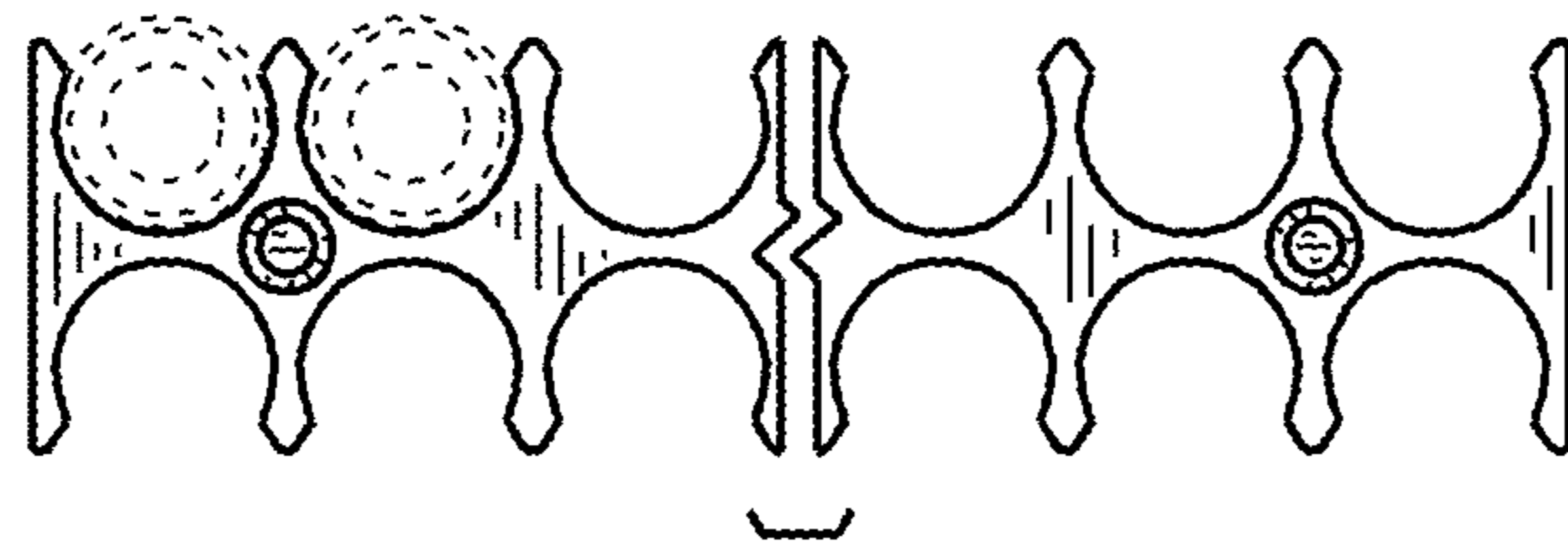

FIG. 14

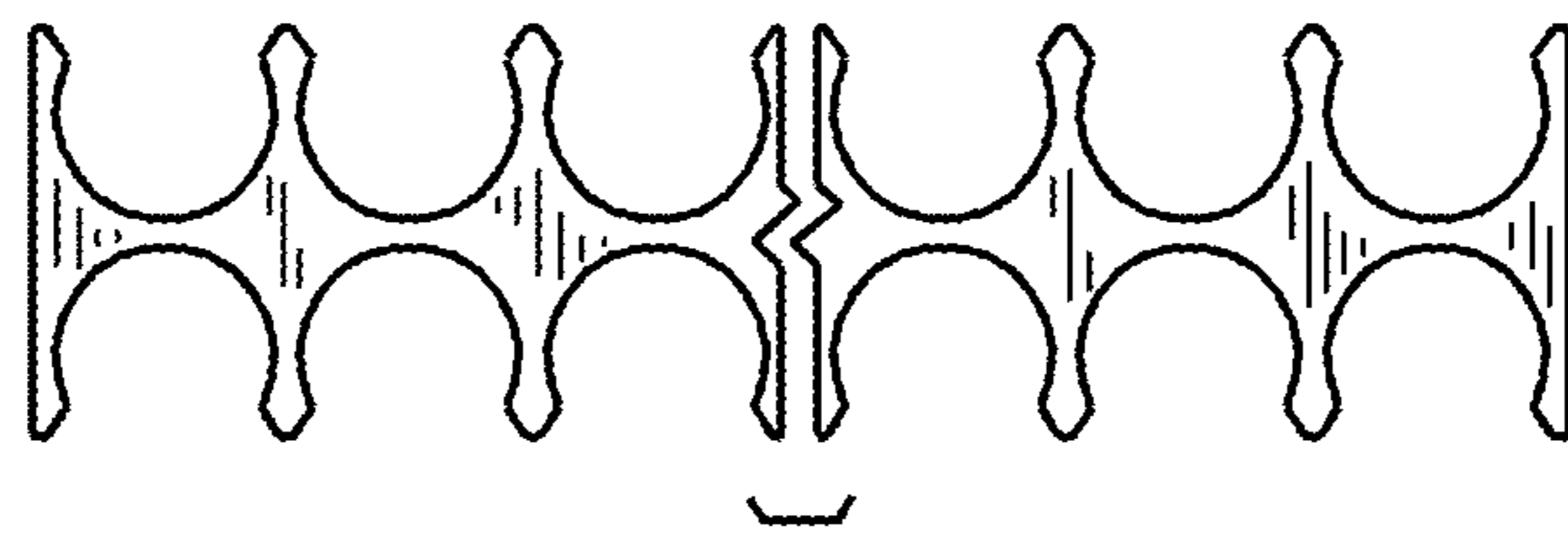

FIG. 15