



US00D753104S

(12) **United States Design Patent**
Kim et al.

(10) **Patent No.:** **US D753,104 S**
(45) **Date of Patent:** **** Apr. 5, 2016**

(54) **ELECTRONIC DEVICE**

(71) Applicant: **Samsung Electronics Co., Ltd.**,
Suwon-si (KR)

(72) Inventors: **Yun-Jin Kim**, Seoul (KR); **Jae-Ho Baik**, Yongin-si (KR); **Min-Hyook Lee**, Seoul (KR)

(73) Assignee: **Samsung Electronics Co., Ltd.**,
Suwon-si (KR)

(**) Term: **14 Years**

(21) Appl. No.: **29/497,263**

(22) Filed: **Jul. 22, 2014**

(30) **Foreign Application Priority Data**

May 21, 2014 (KR) 30-2014-0024889

(51) **LOC (10) Cl.** **14-02**

(52) **U.S. Cl.**
USPC **D14/341**

(58) **Field of Classification Search**
USPC D14/315-318, 341-347, 420, 426, 129,
D14/130, 496, 137, 138 R, 138 AA, 138 C,
D14/138 G, 147, 203.1, 203.3, 204.4, 203.7,
D14/218, 248, 388, 389; D10/50, 65, 104.1;
D21/329, 330; D6/308, 310
CPC ... G06F 3/0485; G06F 3/0488; G06F 1/1613;
G06F 1/1624; G06F 1/1626; G06F 1/165;
H04M 1/0202; H04M 1/0264; H04M 1/0214;
H04M 1/0279; H04M 1/0281; H04M 1/0283;
H04M 1/72544

See application file for complete search history.

(56) **References Cited**

U.S. PATENT DOCUMENTS

D545,300 S * 6/2007 Hong D14/214
D625,307 S * 10/2010 Cheng D14/341

D628,547 S * 12/2010 Park D14/138 AD
D635,135 S * 3/2011 Li D14/315
D654,497 S * 2/2012 Lee D14/341
D671,514 S * 11/2012 Kim D14/138 G

(Continued)

OTHER PUBLICATIONS

Gsmarena, announced Jul. 2014 [online], [site visited Oct. 6, 2015].
Available from Internet, URL: <http://www.gsmarena.com/samsung_galaxy_tab_s_8_4-pictures-6439.php>.*

(Continued)

Primary Examiner — Barbara Fox

Assistant Examiner — Dana K Weiland

(74) *Attorney, Agent, or Firm* — NSIP Law

(57) **CLAIM**

We claim the ornamental design for an electronic device, as shown and described.

DESCRIPTION

FIG. 1 is a front perspective view of an electronic device showing our new design;
FIG. 2 is a front view thereof;
FIG. 3 is a rear view thereof;
FIG. 4 is a left-side view thereof;
FIG. 5 is a right-side view thereof;
FIG. 6 is a top view thereof;
FIG. 7 is a bottom view thereof;
FIG. 8 is a rear perspective view thereof;
FIG. 9 is an enlarged view of the encircled portion in FIG. 6; and,
FIG. 10 is an enlarged view of the encircled portion in FIG. 8.
The broken lines in the figures show portions of the electronic device which form no part of the claimed design.
The dot-dot-dash broken lines encircling portion of the claimed design that are illustrated in enlargements form no part of the claimed design.

1 Claim, 7 Drawing Sheets

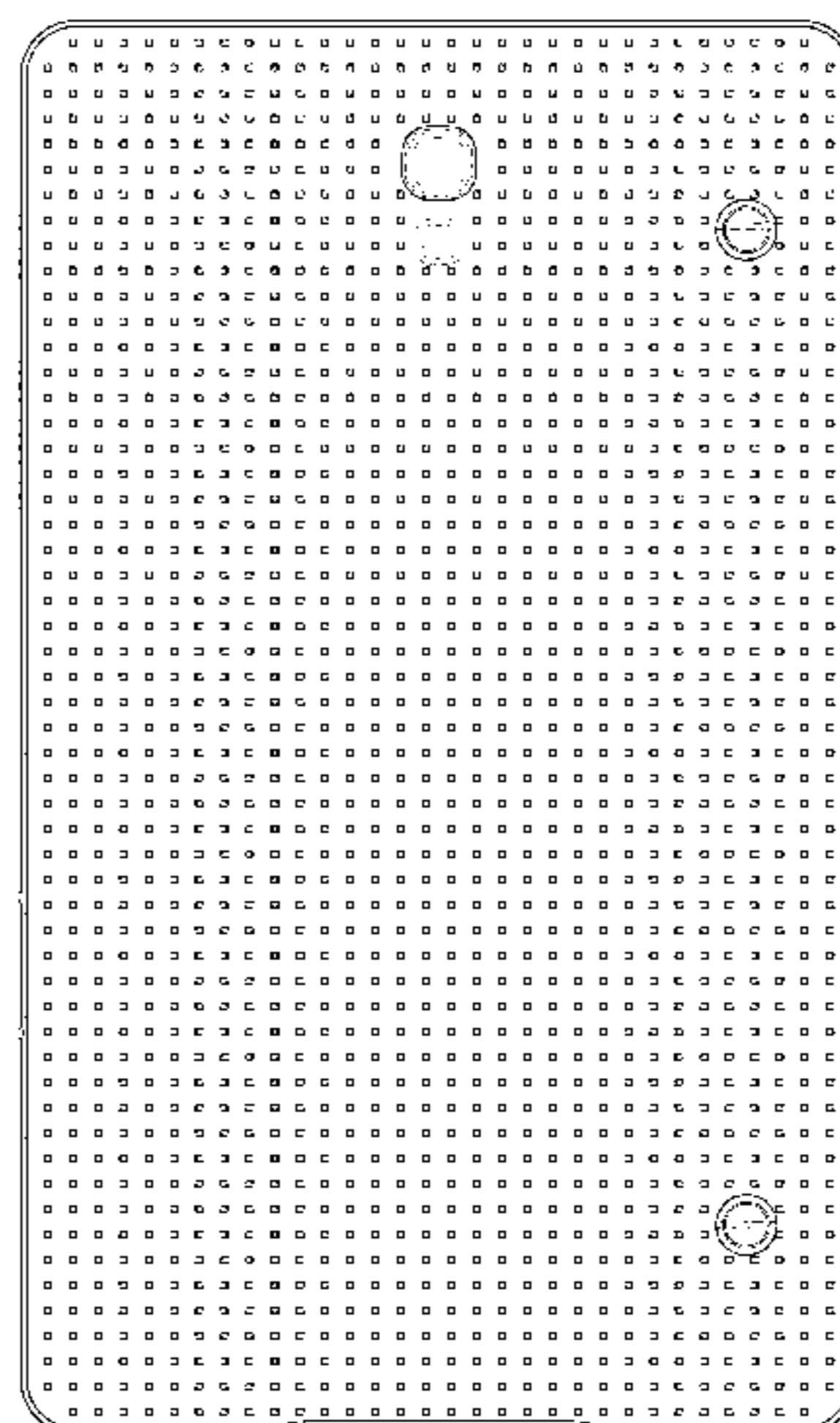
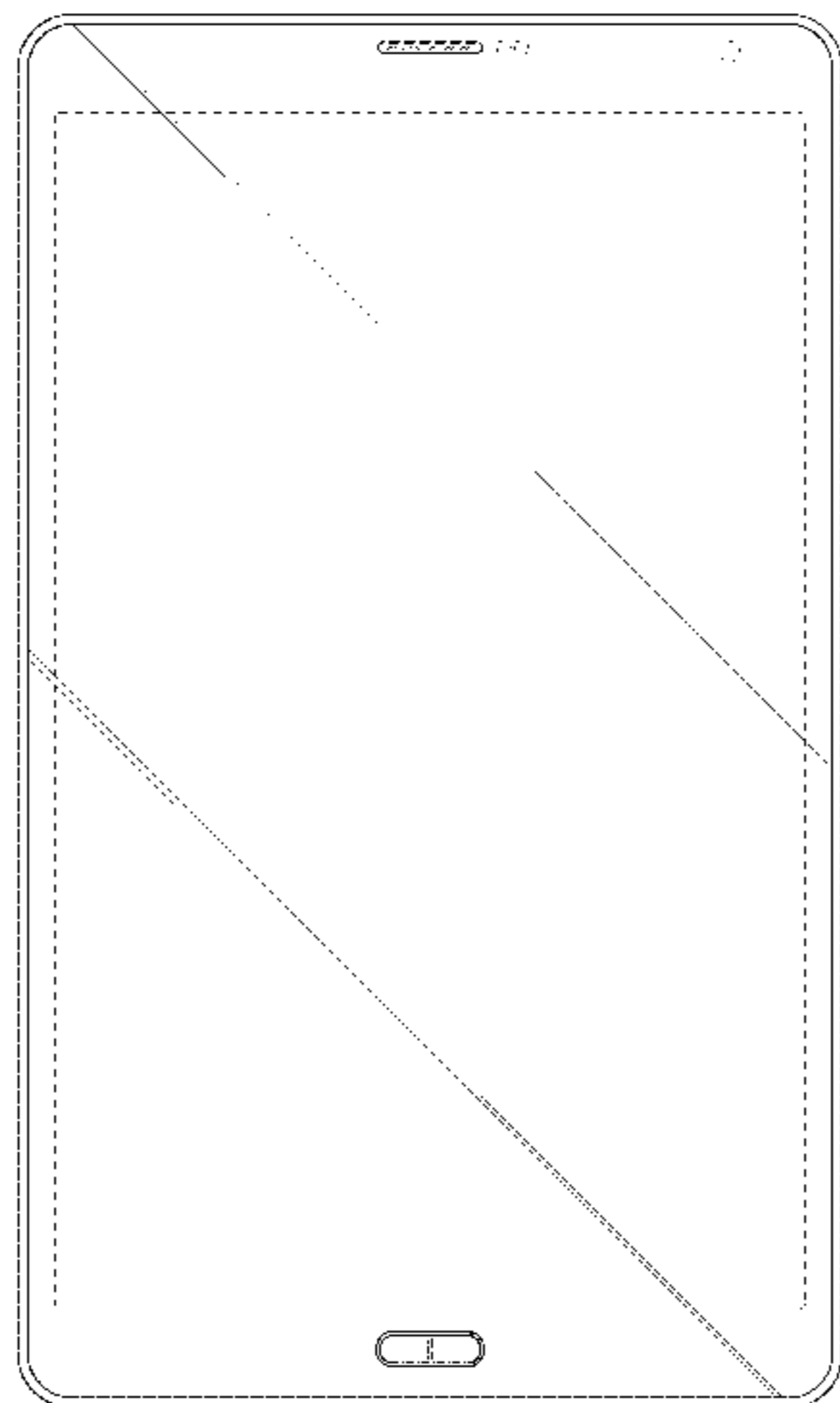

(56)

References Cited

U.S. PATENT DOCUMENTS

D676,819 S * 2/2013 Choi D14/138 G
 D681,632 S * 5/2013 Akana D14/341
 D684,553 S * 6/2013 Kim D14/138 G
 D692,433 S * 10/2013 Akana D14/440
 D693,340 S * 11/2013 Ohshima D14/341
 D695,249 S * 12/2013 Kim D14/138 G
 D696,221 S * 12/2013 Lee D14/138 G
 D698,785 S * 2/2014 Canizares D14/341
 D701,850 S * 4/2014 Kim D14/138 G
 D703,179 S * 4/2014 Choe D14/138 G
 D710,815 S * 8/2014 Kim D14/138 G
 D711,337 S * 8/2014 Park D14/138 G
 D712,400 S * 9/2014 Kim D14/341
 D714,752 S * 10/2014 Im D14/138 G
 D714,785 S * 10/2014 Delpier D14/315
 D715,246 S * 10/2014 Oh D14/138 G
 D715,795 S * 10/2014 McManigal D14/341
 D716,293 S * 10/2014 Hwang D14/341
 D716,747 S * 11/2014 Kleiner D14/138 G
 D716,798 S * 11/2014 Kurimoto D14/341
 D718,303 S * 11/2014 Choteau D14/341
 D720,746 S * 1/2015 Chung D14/341
 D723,490 S * 3/2015 Song D14/138 G
 D723,491 S * 3/2015 Song D14/138 G
 D723,547 S * 3/2015 Zhou D14/341
 D724,063 S * 3/2015 Lee D14/248

D724,537 S * 3/2015 Moore D13/119
 D726,672 S * 4/2015 Olodort D14/138 G
 D727,304 S * 4/2015 Lee D14/248
 D727,881 S * 4/2015 Lee D14/248
 D729,781 S * 5/2015 Lee D14/248
 D736,203 S * 8/2015 Kim D14/341
 D737,793 S * 9/2015 Lee D14/138 G
 D738,341 S * 9/2015 Choi D14/138 G
 D740,806 S * 10/2015 Fujimoto D14/341
 2014/0111548 A1 * 4/2014 Shin G09G 5/32
 345/650
 2014/0285329 A1 * 9/2014 Lee G08B 6/00
 340/407.1

OTHER PUBLICATIONS

Youtube S 8.4 Review, announced Jun. 24, 2014 [online], [site visited Oct. 6, 2015]. Available from Internet, URL: <https://www.youtube.com/watch?v=MKh_eF95lxl>.*
 Youtube S 10.5, announced Jun. 13, 2014 [online], [site visited Oct. 6, 2015]. Available from Internet, URL: <<https://www.youtube.com/watch?v=fJd3Z45sThQ>>.*
 Gadgetreviewed, Features and Specifications, announced Aug. 26, 2014[online], [site visited Oct. 6, 2015]. Available from Internet, URL: <<http://www.gadgetreviewed.com/reviews/samsung-galaxy-tab-s-10-5-a-power-performance-capacity-with-good-battery-life/120/>>.*

* cited by examiner

FIG. 1

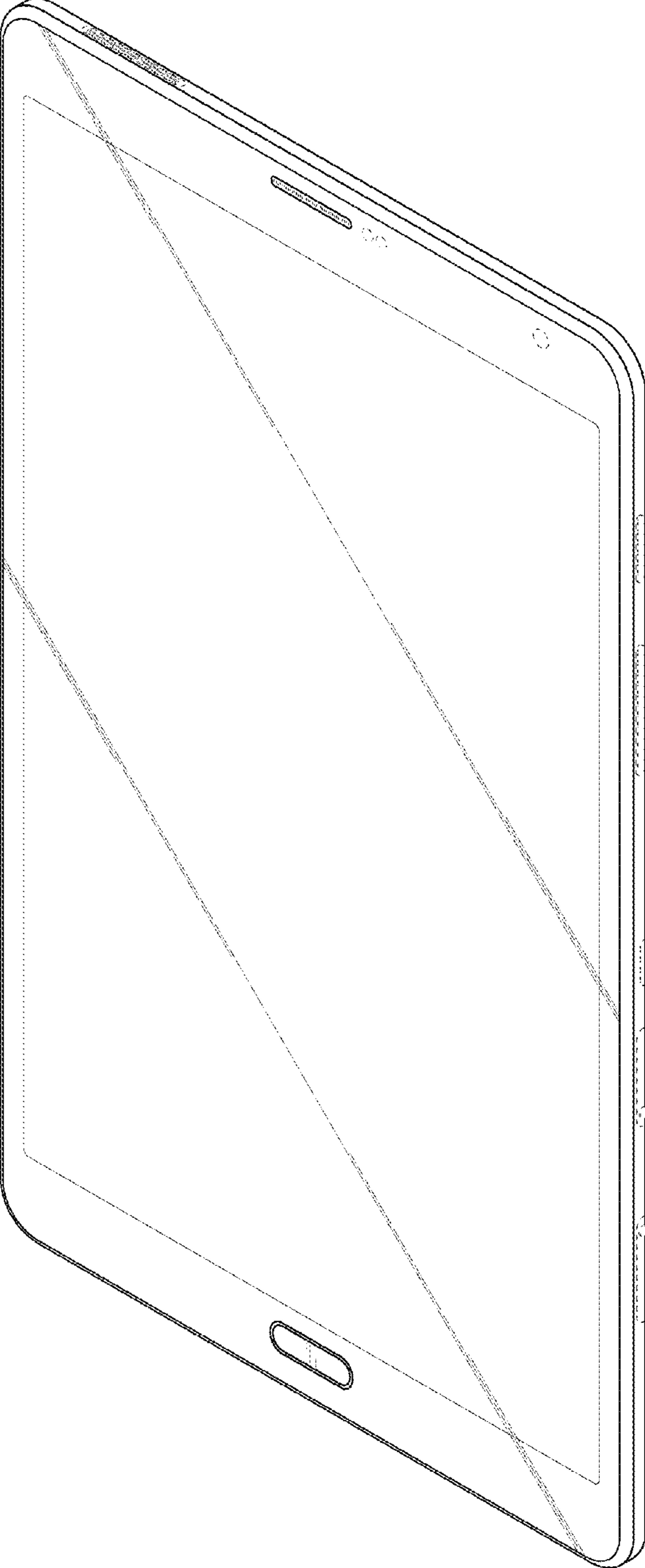

FIG.2

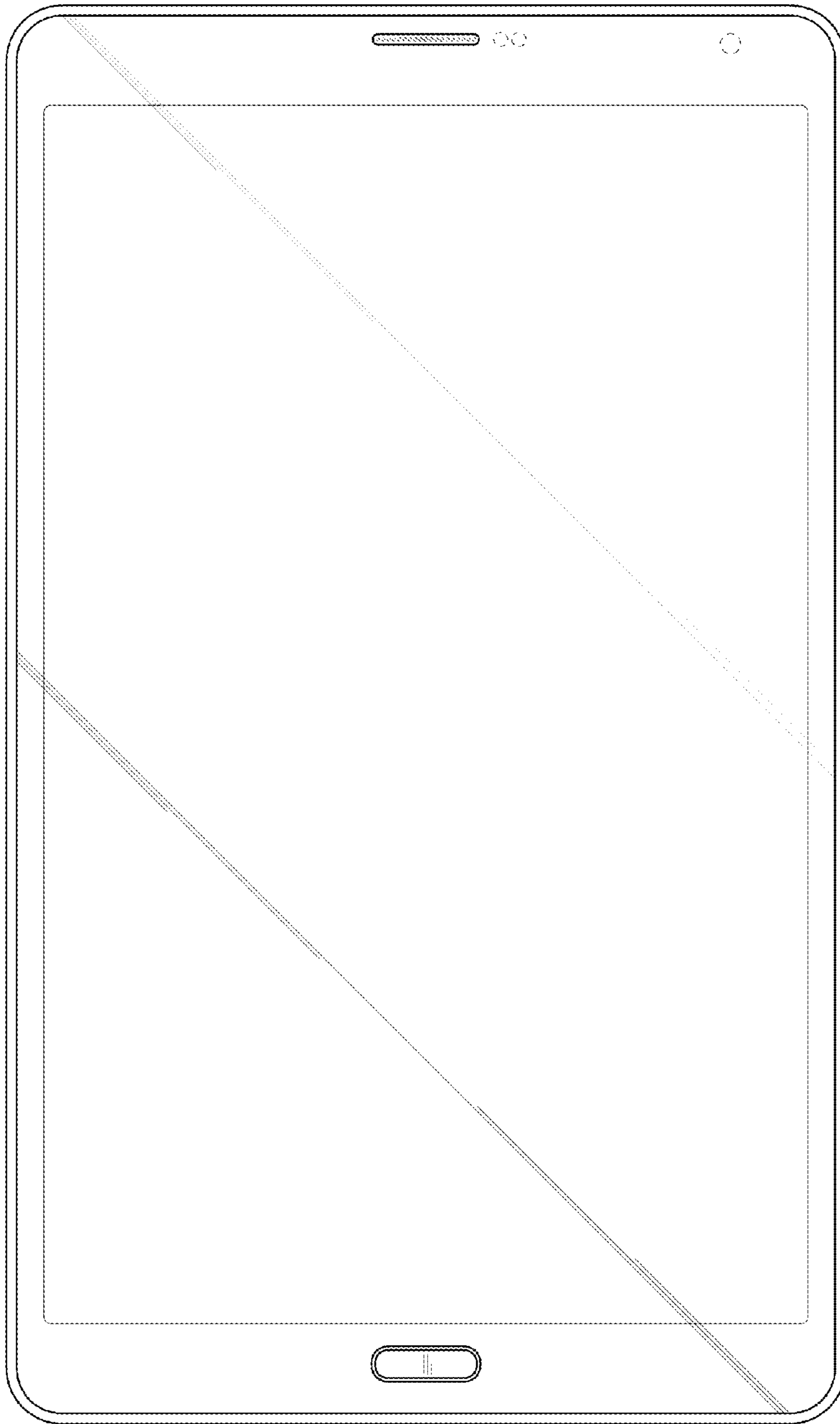

FIG.3

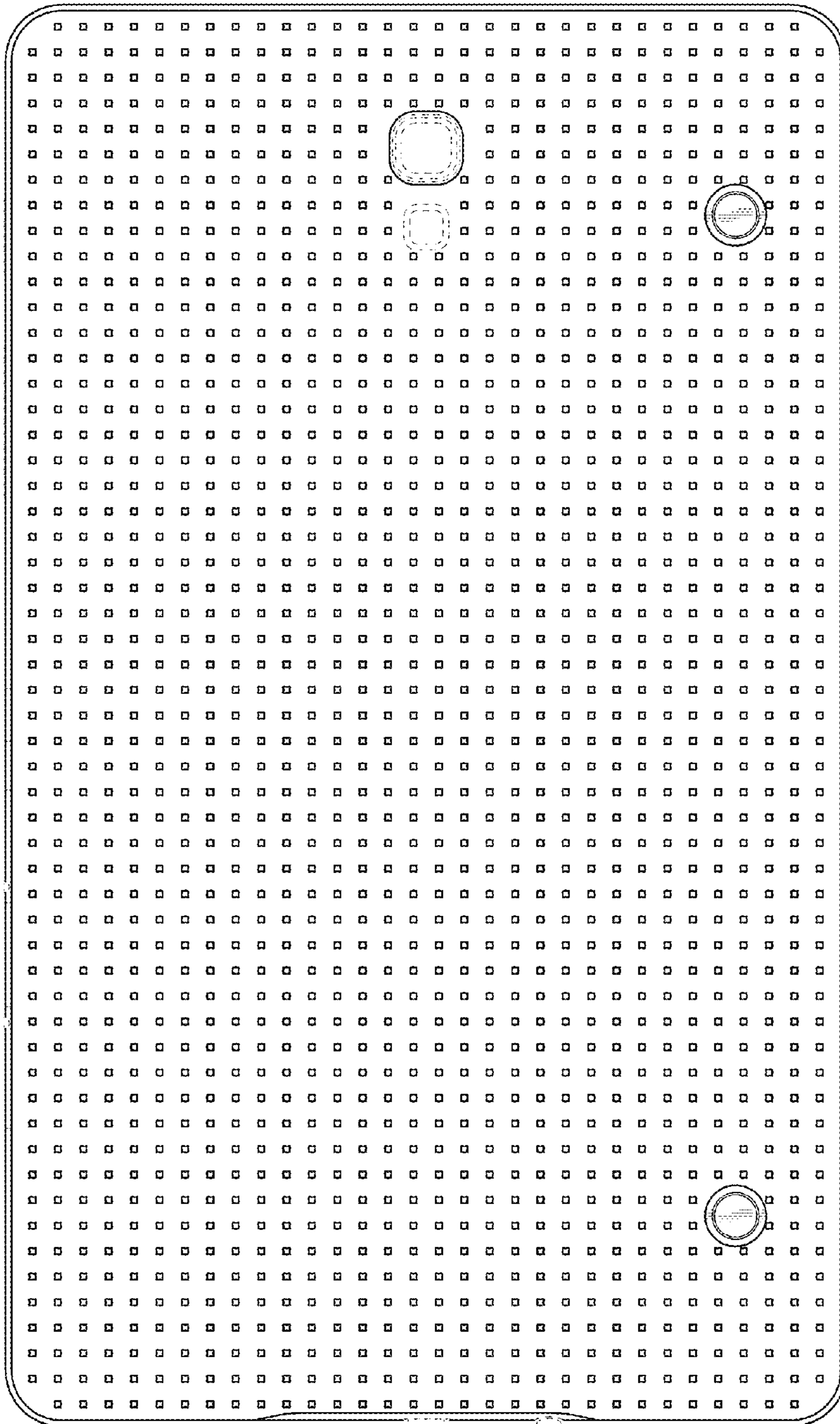

FIG.4



FIG.5



FIG.6

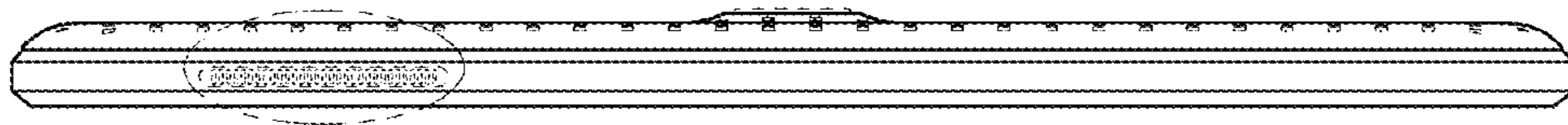

FIG.7

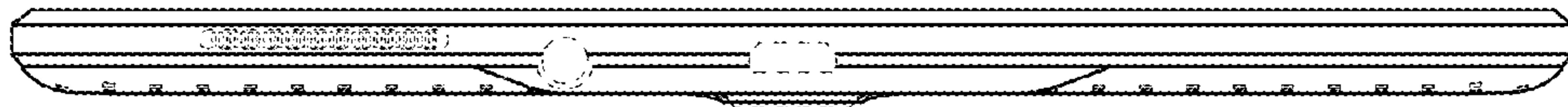

FIG.8

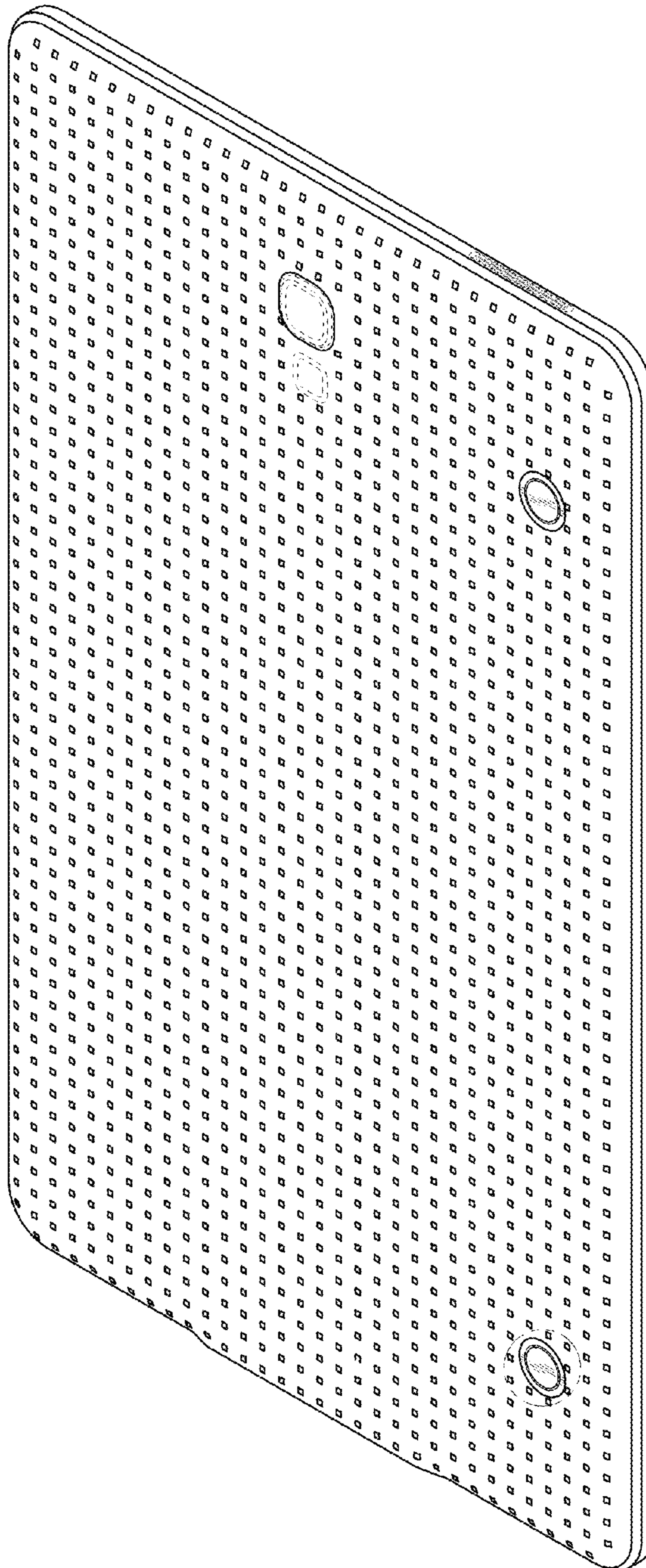

FIG.9

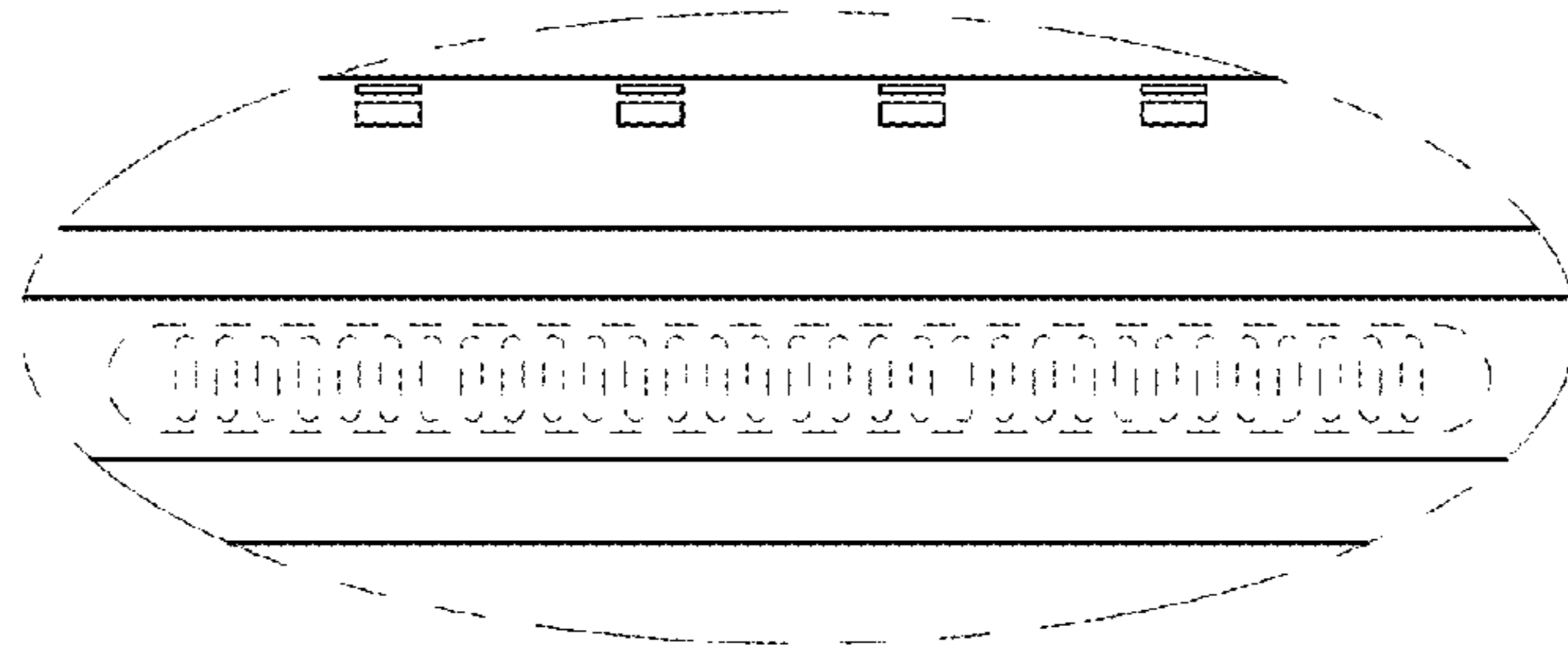

FIG.10

