



US00D753087S

(12) **United States Design Patent**
Cai

(10) **Patent No.:** **US D753,087 S**

(45) **Date of Patent:** **** Apr. 5, 2016**

(54) **SMART PHONE**

(71) Applicant: **LENOVO (BEIJING) CO., LTD.**,
Beijing (CN)

(72) Inventor: **Xiao Cai**, Beijing (CN)

(73) Assignee: **Lenovo (Beijing) Co., Ltd.**, Beijing
(CN)

(**) Term: **14 Years**

(21) Appl. No.: **29/482,002**

(22) Filed: **Feb. 12, 2014**

(30) **Foreign Application Priority Data**

Aug. 12, 2013 (CN) 2013 3 0385198

(51) **LOC (10) Cl.** **14-03**

(52) **U.S. Cl.**
USPC **D14/138 AA**

(58) **Field of Classification Search**

USPC D14/137, 138 R, 138 AA, 138 C, 138 G,
D14/142, 144, 147, 240, 247, 248, 250,
D14/341-347, 496, 138; D13/168; D18/7;
455/90.2, 90.3, 550.1, 556.1, 556.2;
379/433.01; 348/14.02; D25/119, 121,
D25/123

CPC ... H04M 1/02; H04M 1/0202; H04M 1/0206;
H04M 1/0208; H04M 1/021; H04M 1/0212;
H04M 1/0214; H04M 1/0216; H04M 1/0241;
H04M 1/0264; G06F 1/1626

See application file for complete search history.

(56) **References Cited**

U.S. PATENT DOCUMENTS

D456,023 S * 4/2002 Andre D14/375
D558,460 S * 1/2008 Yu D14/341

(Continued)

Primary Examiner — Sandra Snapp

(74) *Attorney, Agent, or Firm* — Oppedahl Patent Law Firm
LLC

(57) **CLAIM**

The ornamental design for a smart phone, as shown and described.

DESCRIPTION

FIG. 1 is a front side elevation view of a first embodiment of our new design for a smart phone, with an end piece a rotated position and a stand in an open position.

FIG. 2 is a back side elevation view of FIG. 1.

FIG. 3 is a left side elevation view of FIG. 1.

FIG. 4 is a right side elevation view of FIG. 1.

FIG. 5 is a top side plan view of FIG. 1.

FIG. 6 is a bottom side plan view of FIG. 1.

FIG. 7 is a front side perspective view of FIG. 1.

FIG. 8 is a front side elevation view of the first embodiment electronic device with end piece not rotated and the stand in closed position, it being understood that all other surfaces are the same as the embodiment of FIG. 1.

FIG. 9 is a back side elevation view of FIG. 8.

FIG. 10 is a left side elevation view of FIG. 8.

FIG. 11 is a right side elevation view of FIG. 8.

FIG. 12 is a top side plan view of FIG. 8.

FIG. 13 is a bottom side plan view of FIG. 8.

FIG. 14 is a front top side perspective view of FIG. 8.

FIG. 15 is a front side elevation view of a second embodiment of our new design for a smart phone, with an end piece in a rotated position and a stand in an open position.

FIG. 16 is a back side elevation view of FIG. 15.

FIG. 17 is a left side elevation view of FIG. 15.

FIG. 18 is a right side elevation view of FIG. 15.

FIG. 19 is a top side plan view of FIG. 15.

FIG. 20 is a bottom side plan view of FIG. 15.

FIG. 21 is a front side perspective view of FIG. 15.

FIG. 22 is a front side elevation view of the second embodiment electronic device with end piece not rotated and the stand in closed position, it being understood that all other surfaces are the same as the embodiment of FIG. 15.

FIG. 23 is a back side elevation view of FIG. 22.

FIG. 24 is a left side elevation view of FIG. 22.

FIG. 25 is a right side elevation view of FIG. 22.

FIG. 26 is a top side plan view of FIG. 22.

FIG. 27 is a bottom side plan view of FIG. 22; and,

FIG. 28 is a front top side perspective view of FIG. 22.

The features shown in broken lines in the drawing depict environmental subject matter and unclaimed borders and form no part of the claimed design. Other than the section disclaimed by the broken lines and unclaimed borders, it is to be understood that all other surfaces are the same in all embodiments.

1 Claim, 20 Drawing Sheets

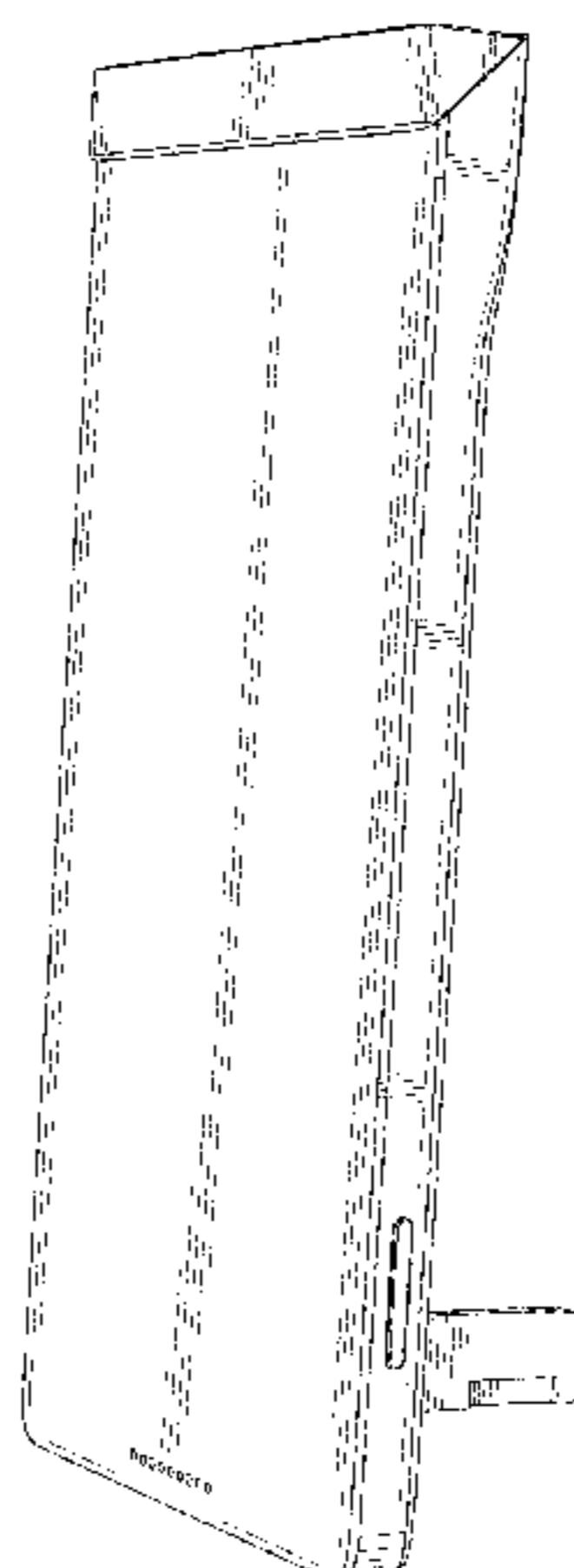

(56)

References Cited

U.S. PATENT DOCUMENTS

D590,386 S * 4/2009 Leith D14/248
D590,822 S * 4/2009 Leith D14/248
D598,888 S * 8/2009 Wei D14/138 AA
D601,353 S * 10/2009 Sadler D14/371
D617,300 S * 6/2010 Tzeng D14/138 AA

D678,877 S * 3/2013 Groene D14/341
D681,582 S * 5/2013 Park D14/138 C
D691,980 S * 10/2013 Park D14/138 G
D719,152 S * 12/2014 Ahn D14/345
D728,559 S * 5/2015 Lim D14/341
2014/0085777 A1 * 3/2014 Yeh H04M 1/0202
361/679.01

* cited by examiner

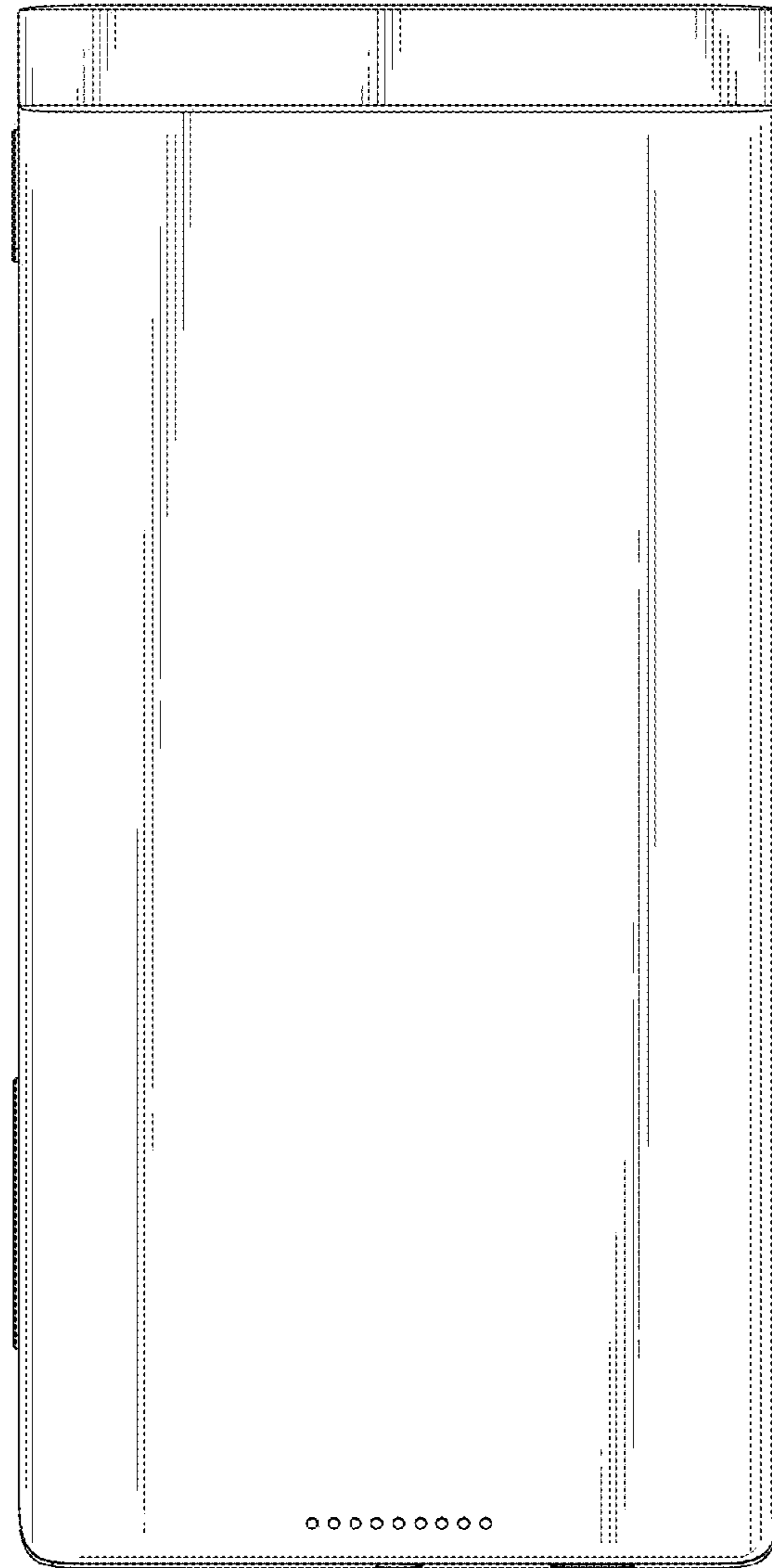

FIG.1

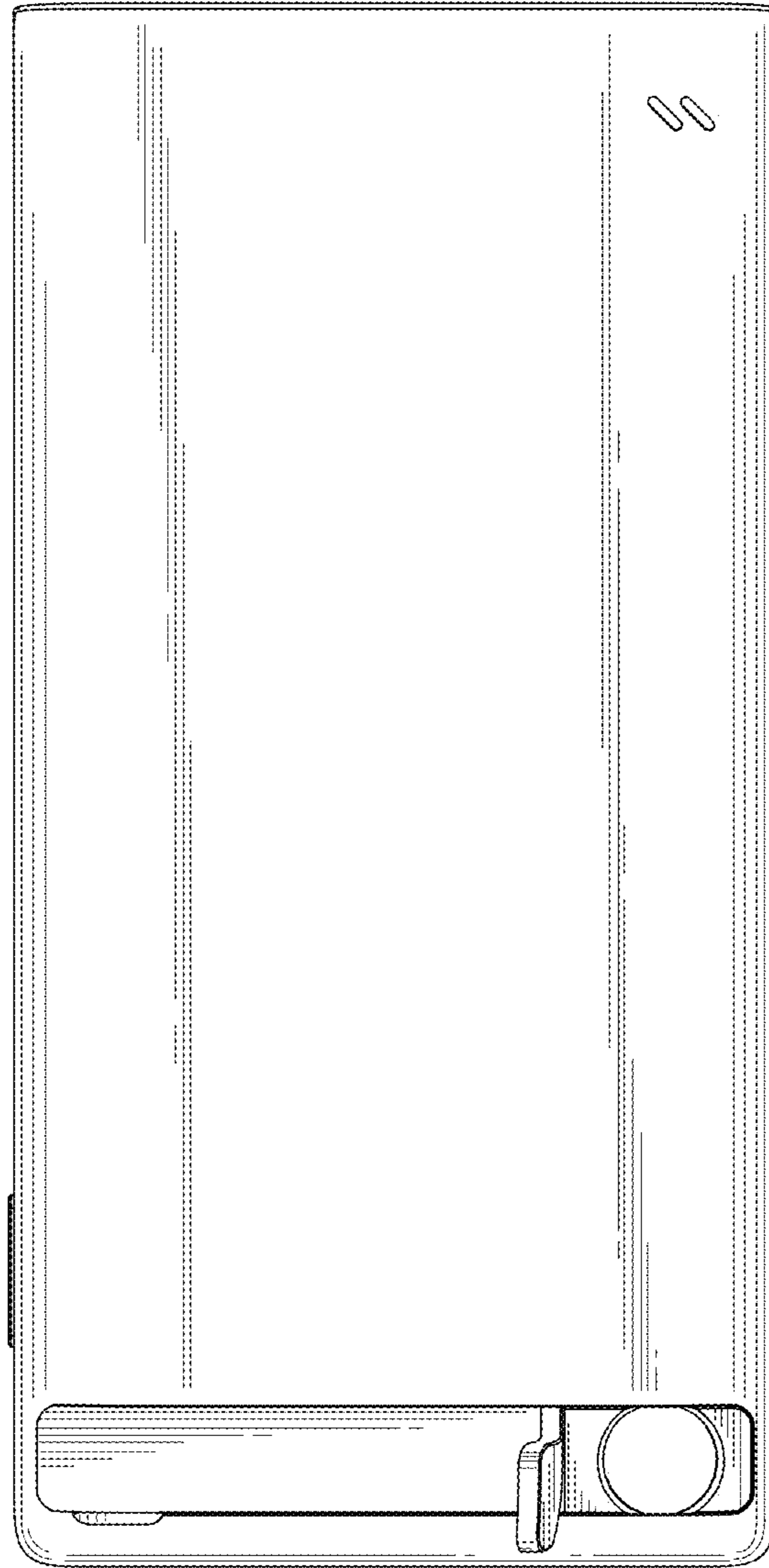

FIG. 2

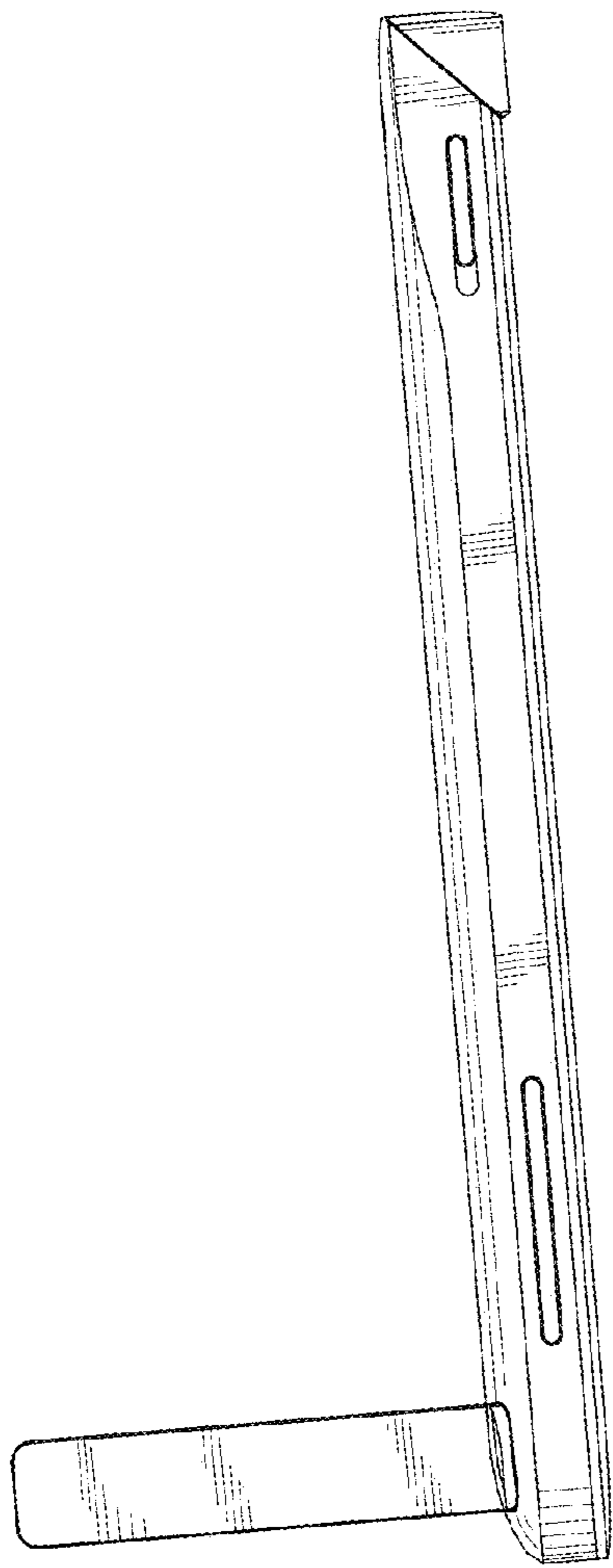

FIG. 3

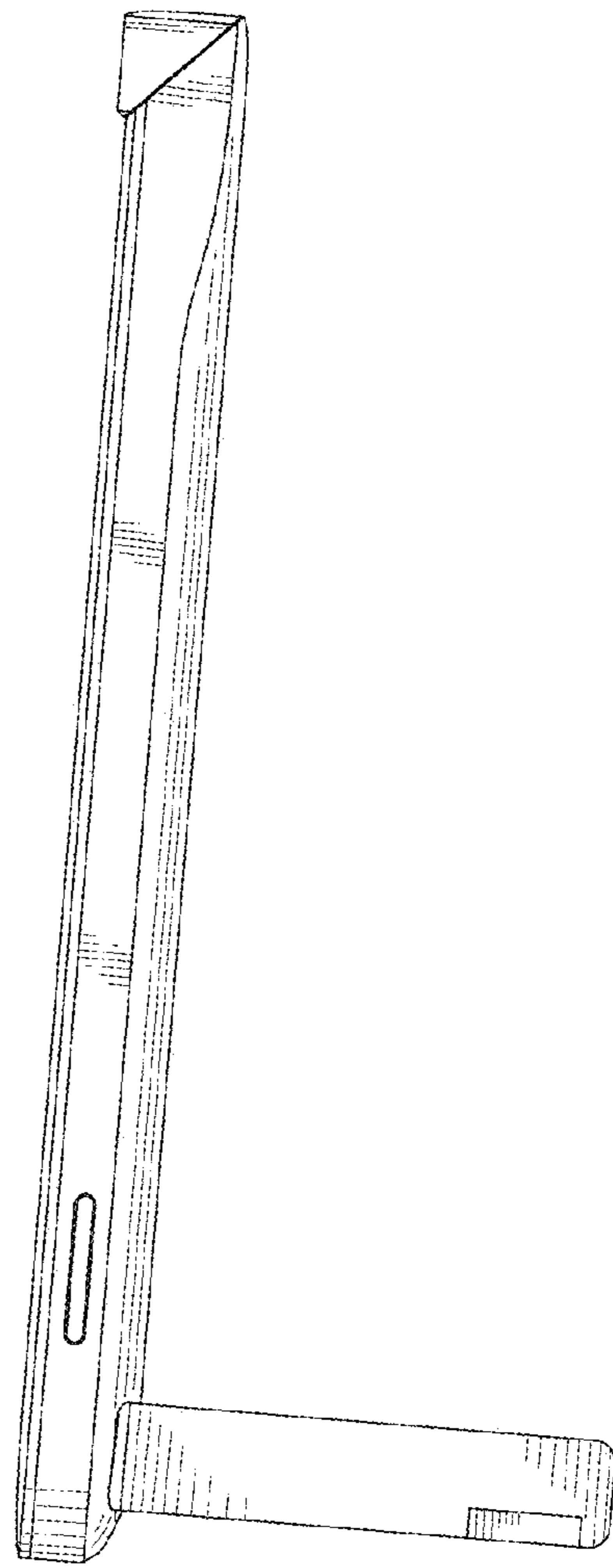

FIG. 4

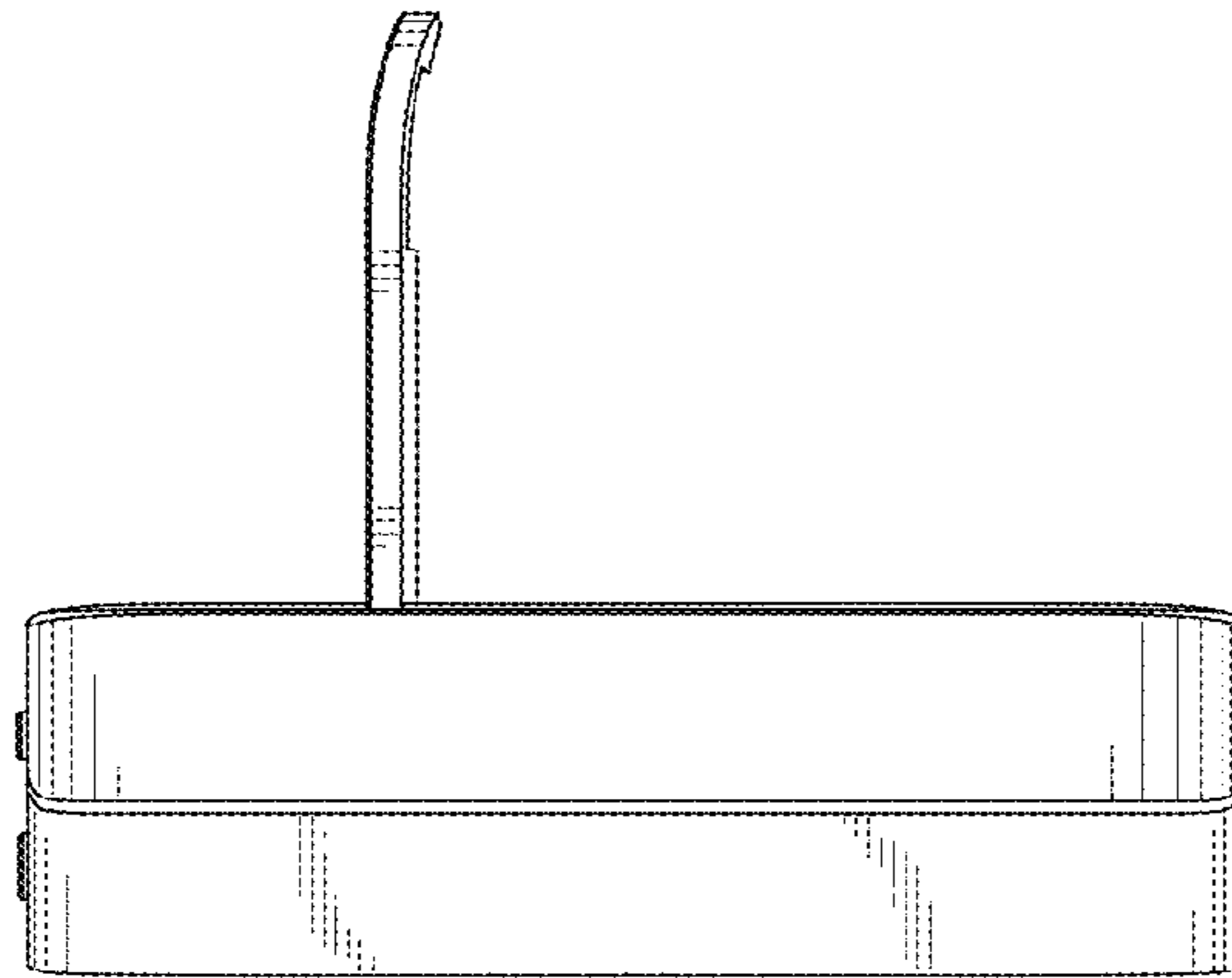

FIG. 5

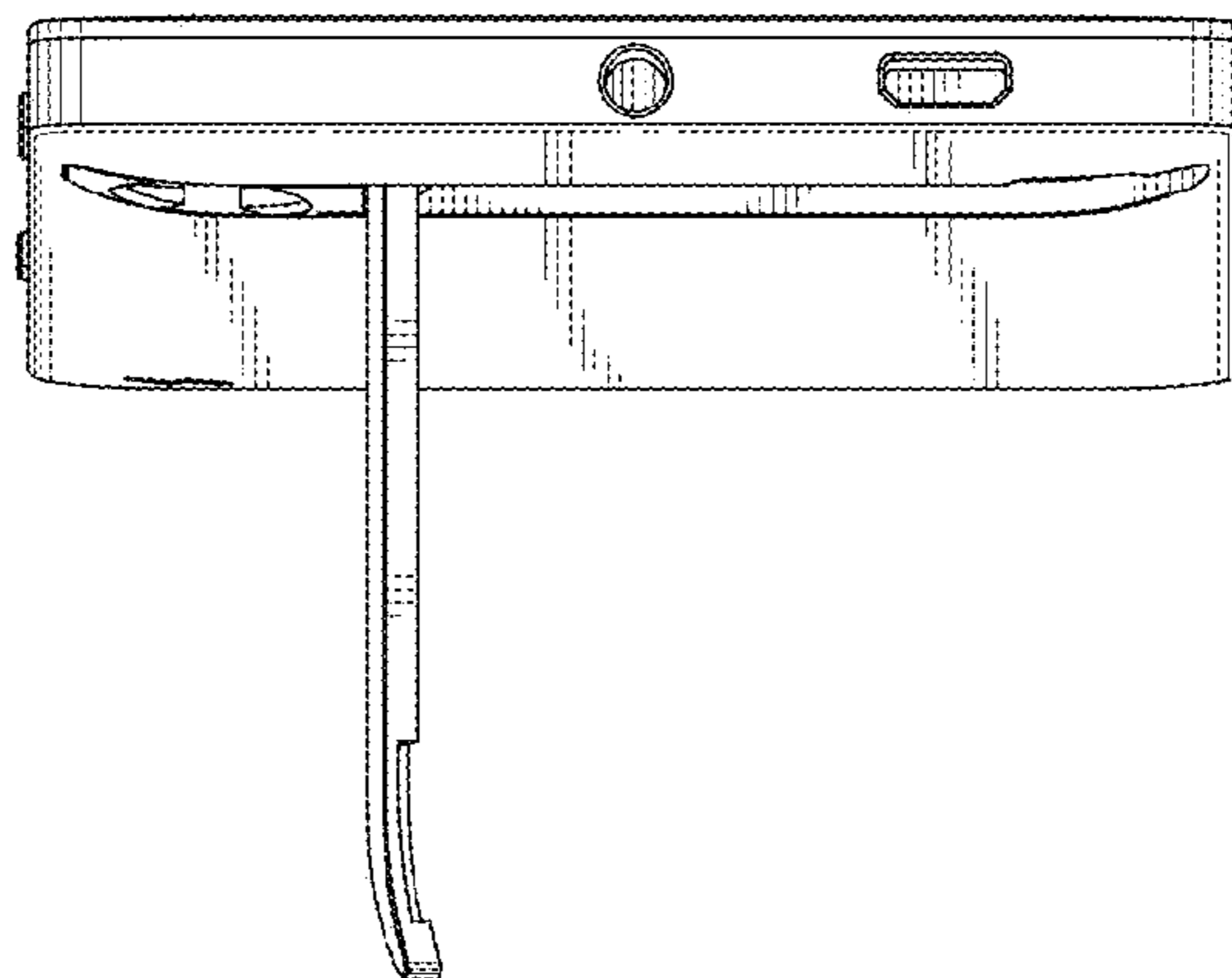

FIG. 6

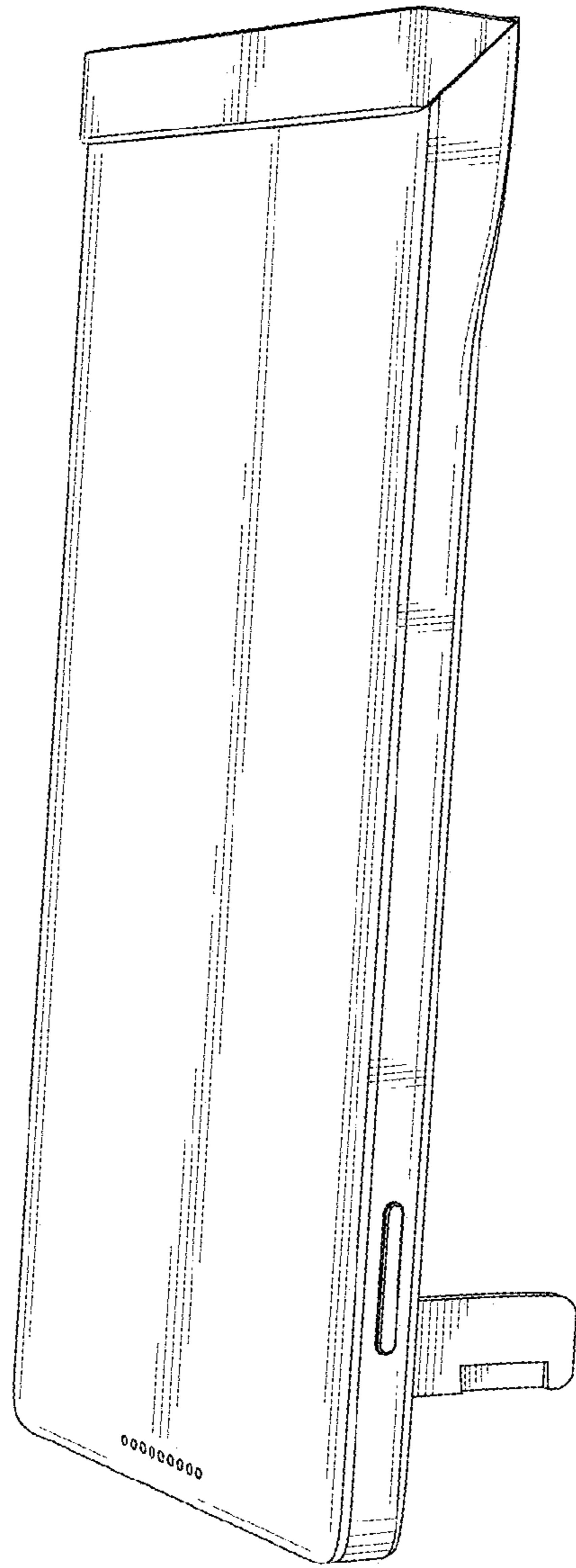

FIG.7

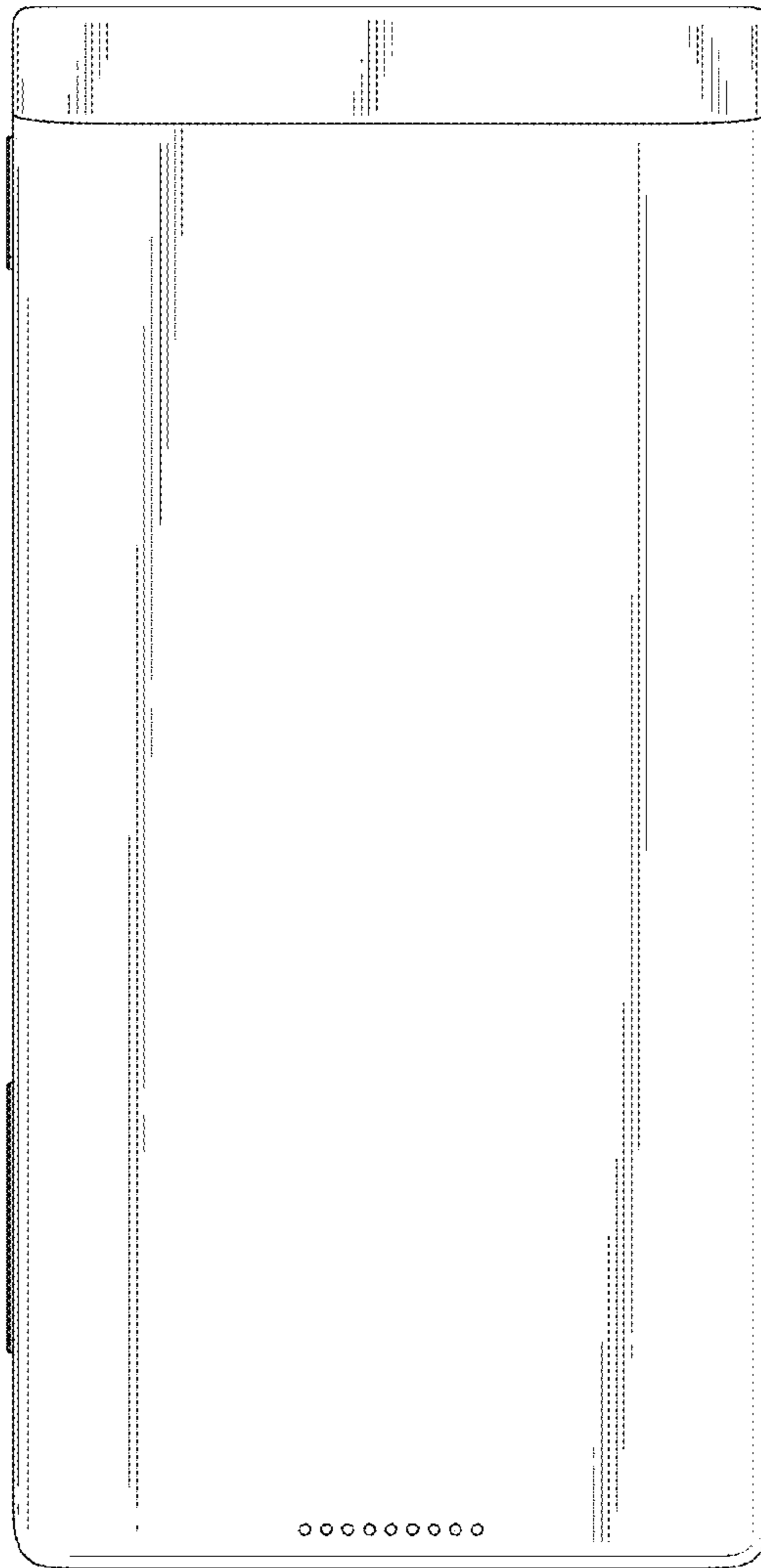

FIG.8

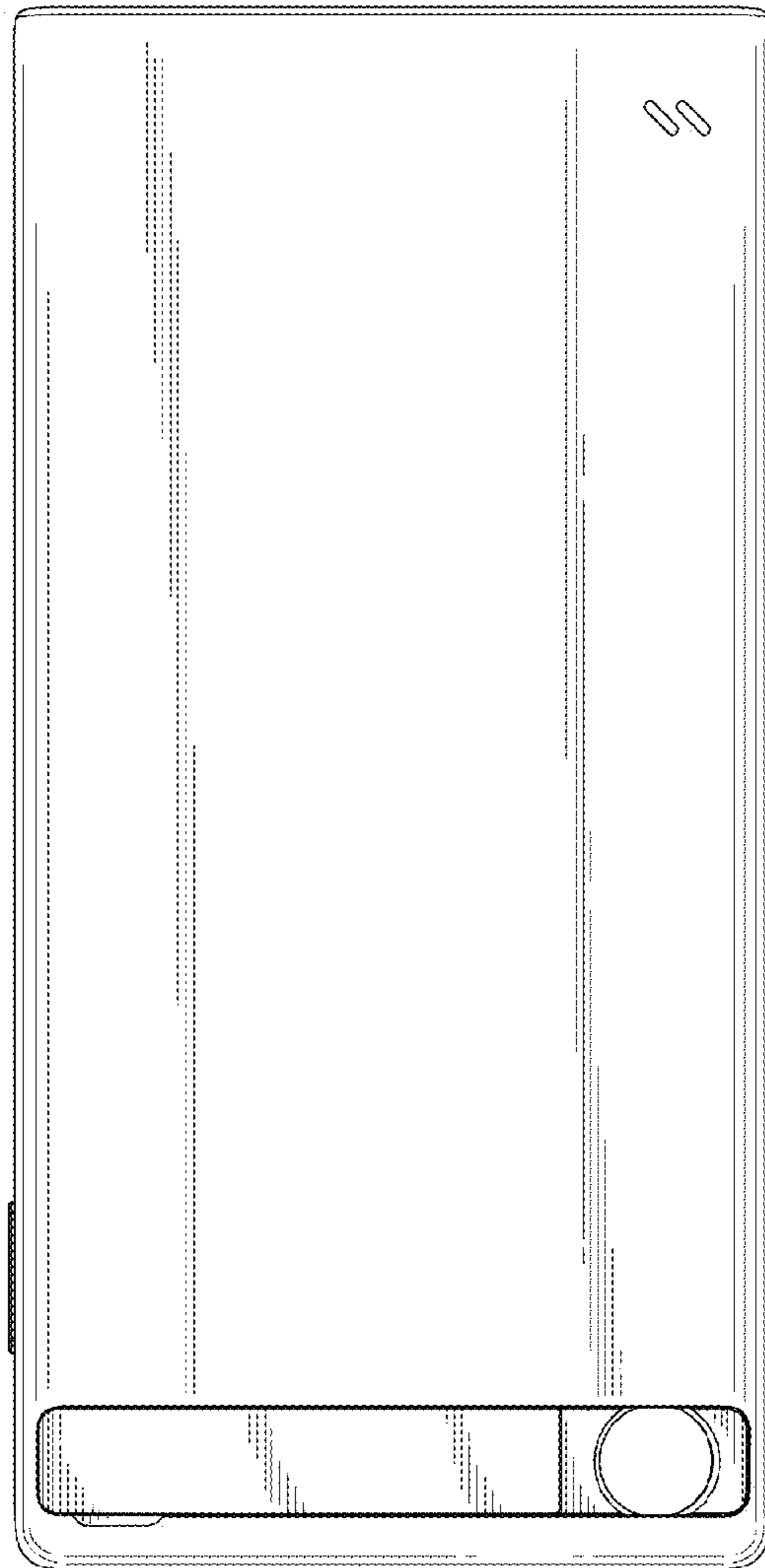

FIG.9

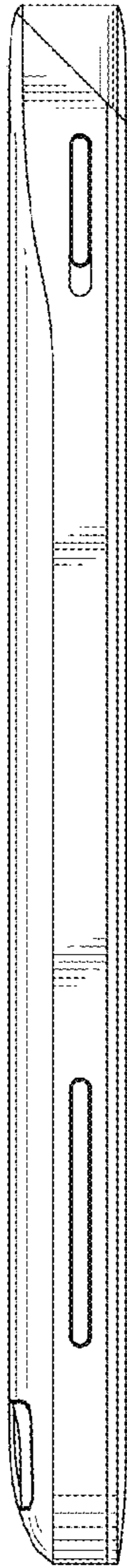

FIG. 10

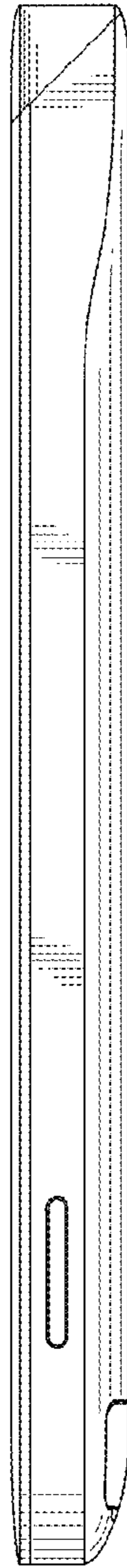

FIG. 11



FIG. 12

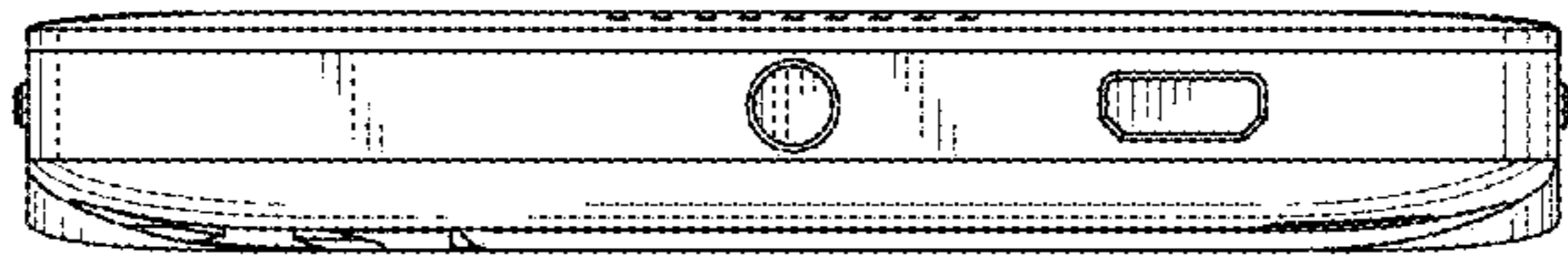

FIG. 13

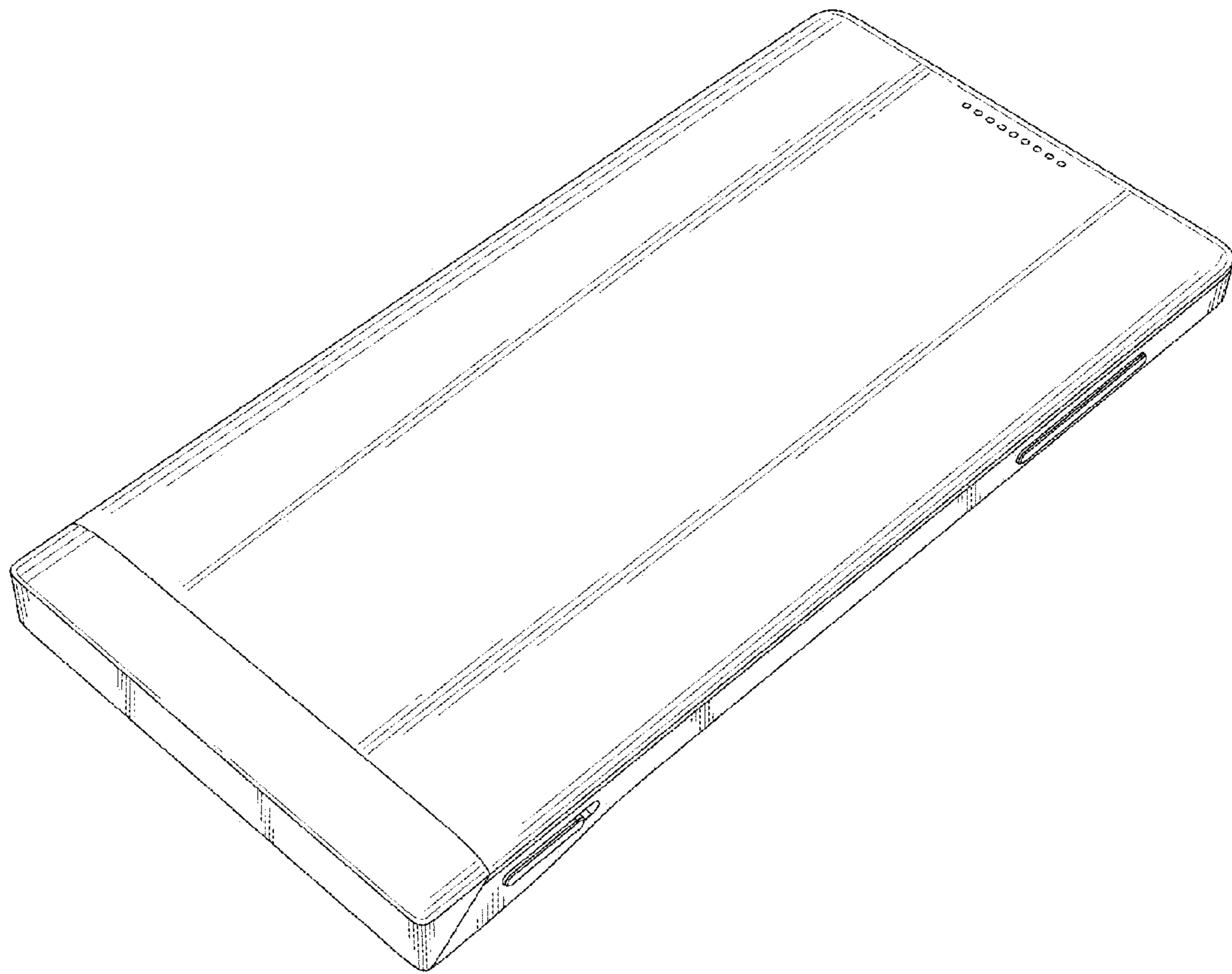

FIG.14

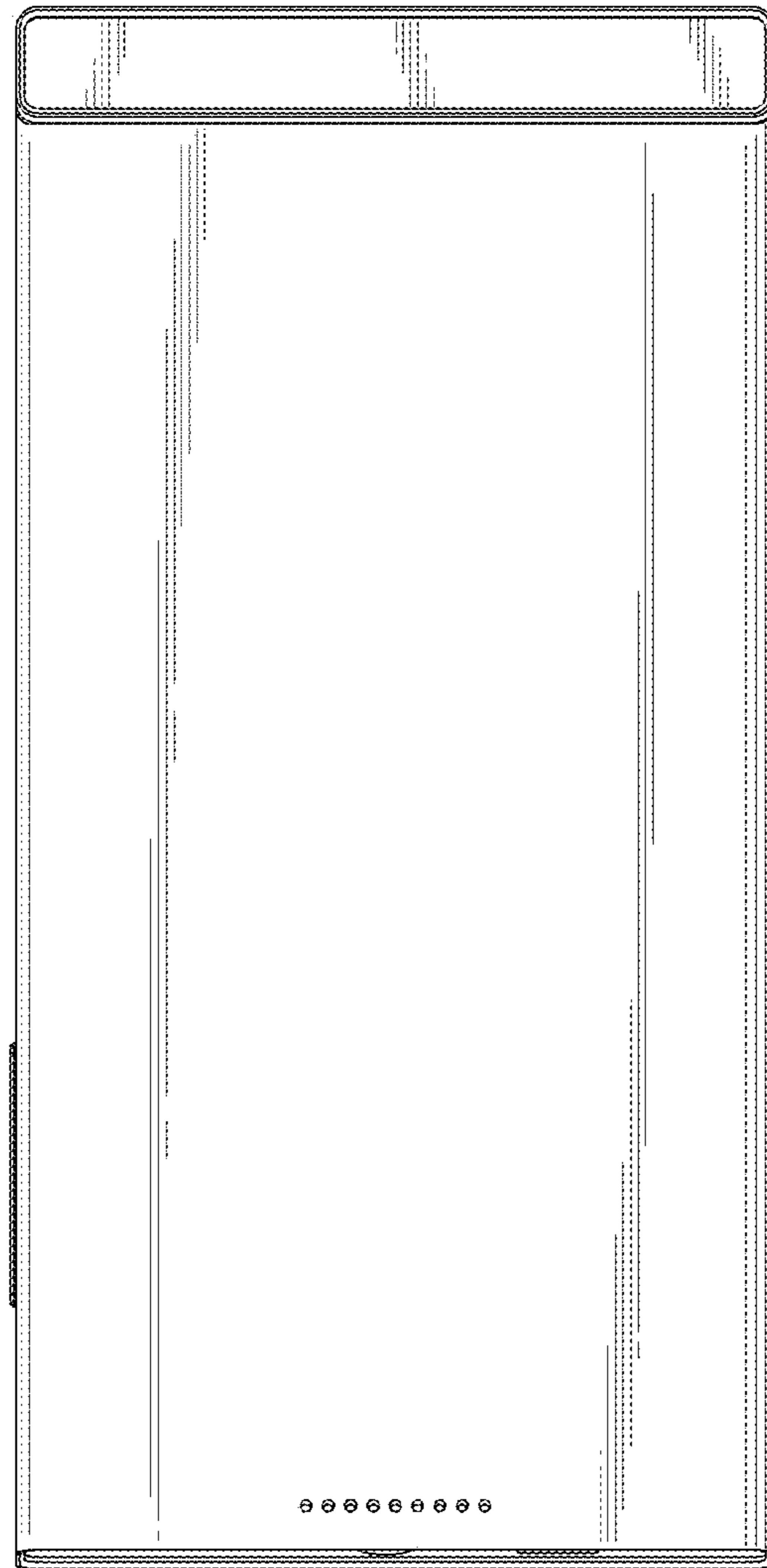

FIG. 15

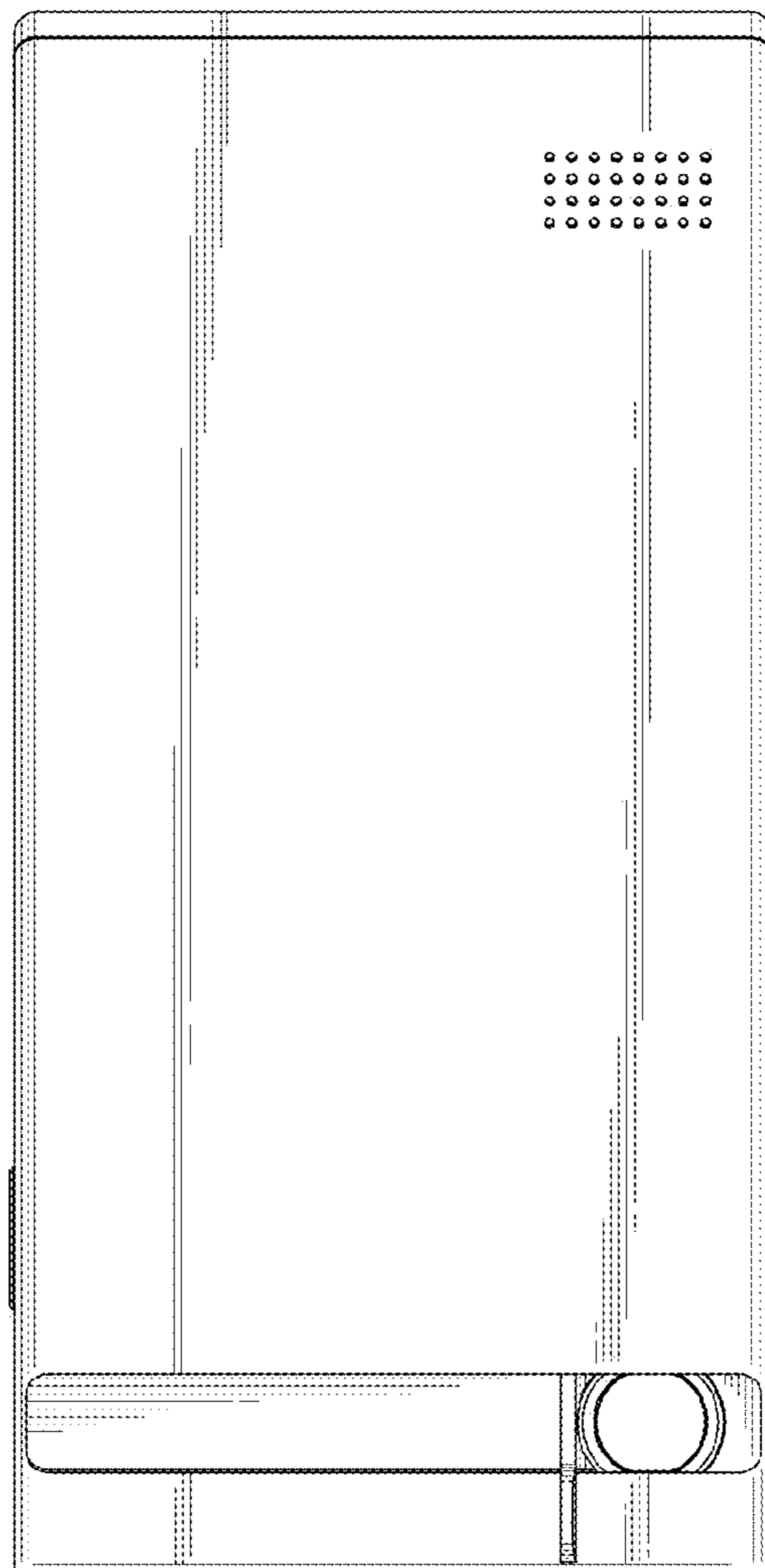

FIG.16

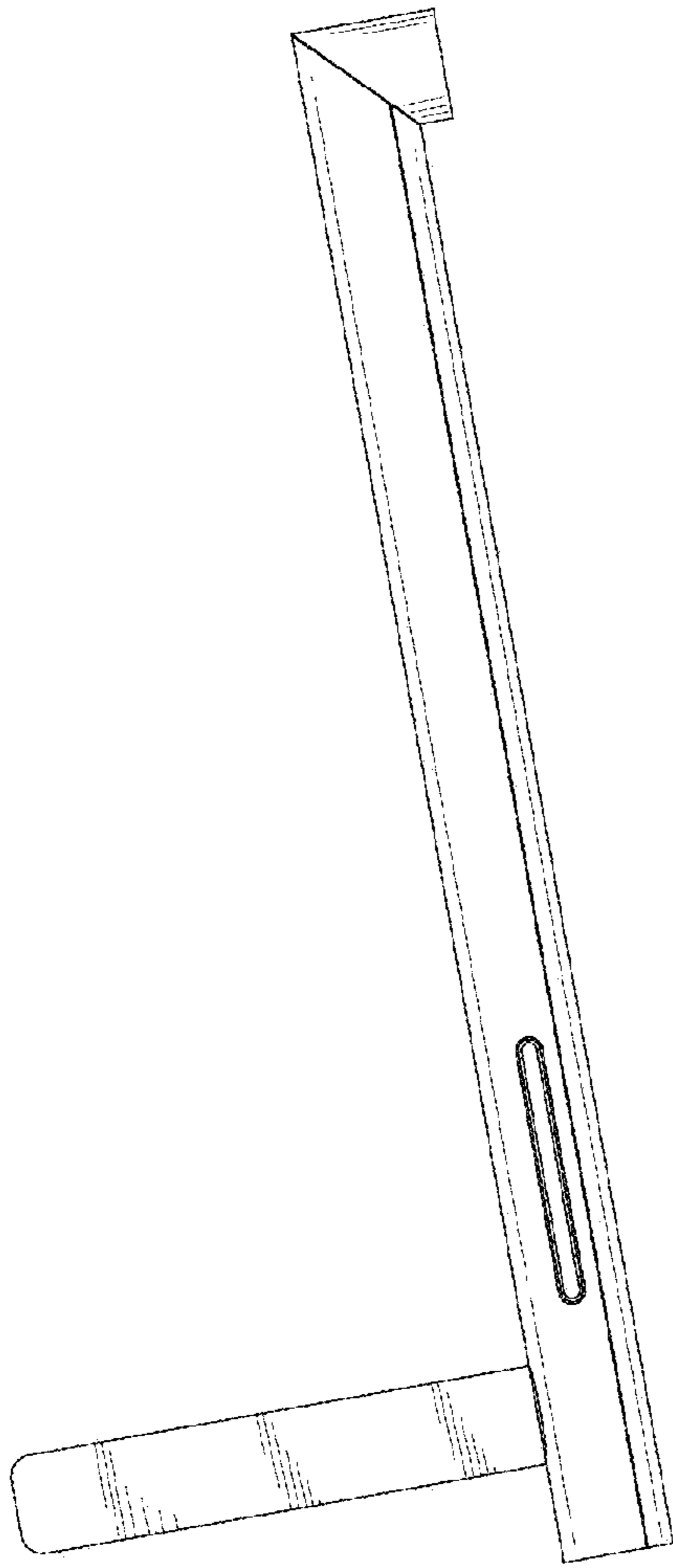

FIG. 17

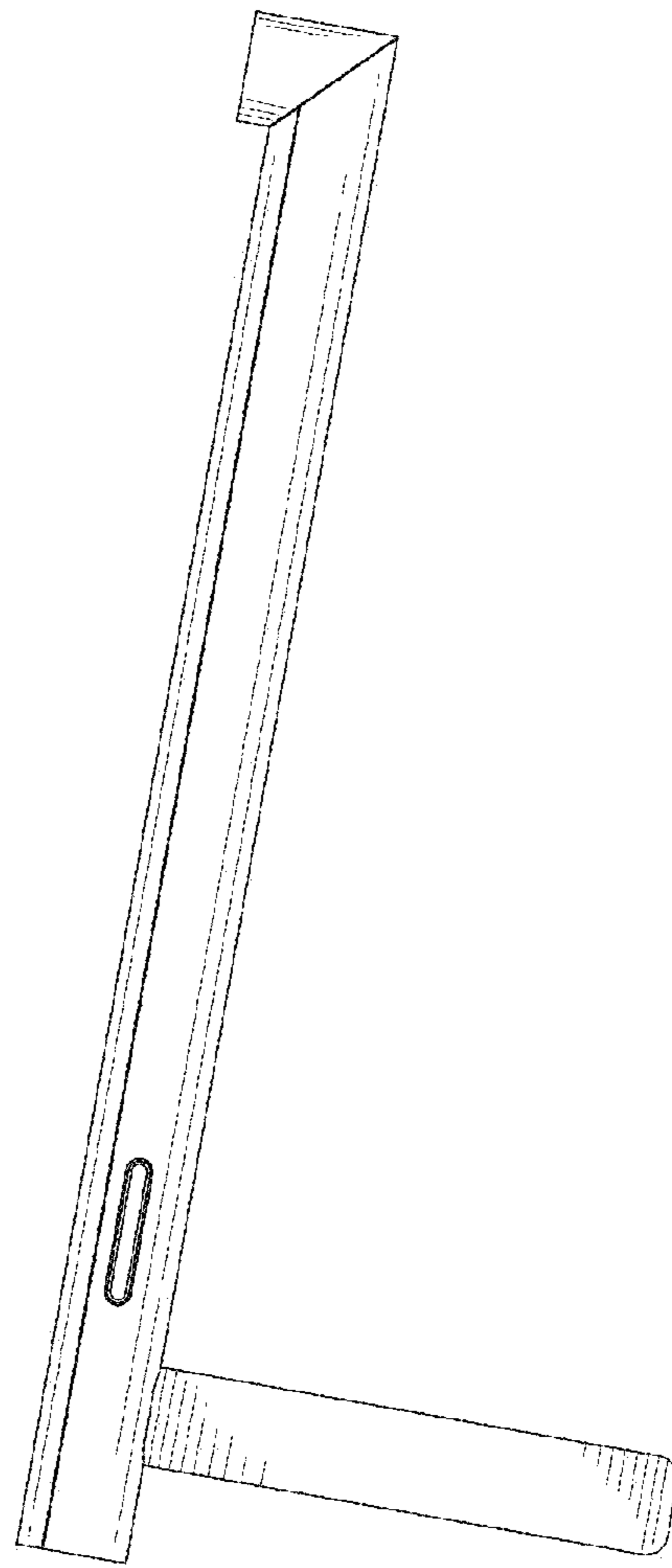

FIG. 18

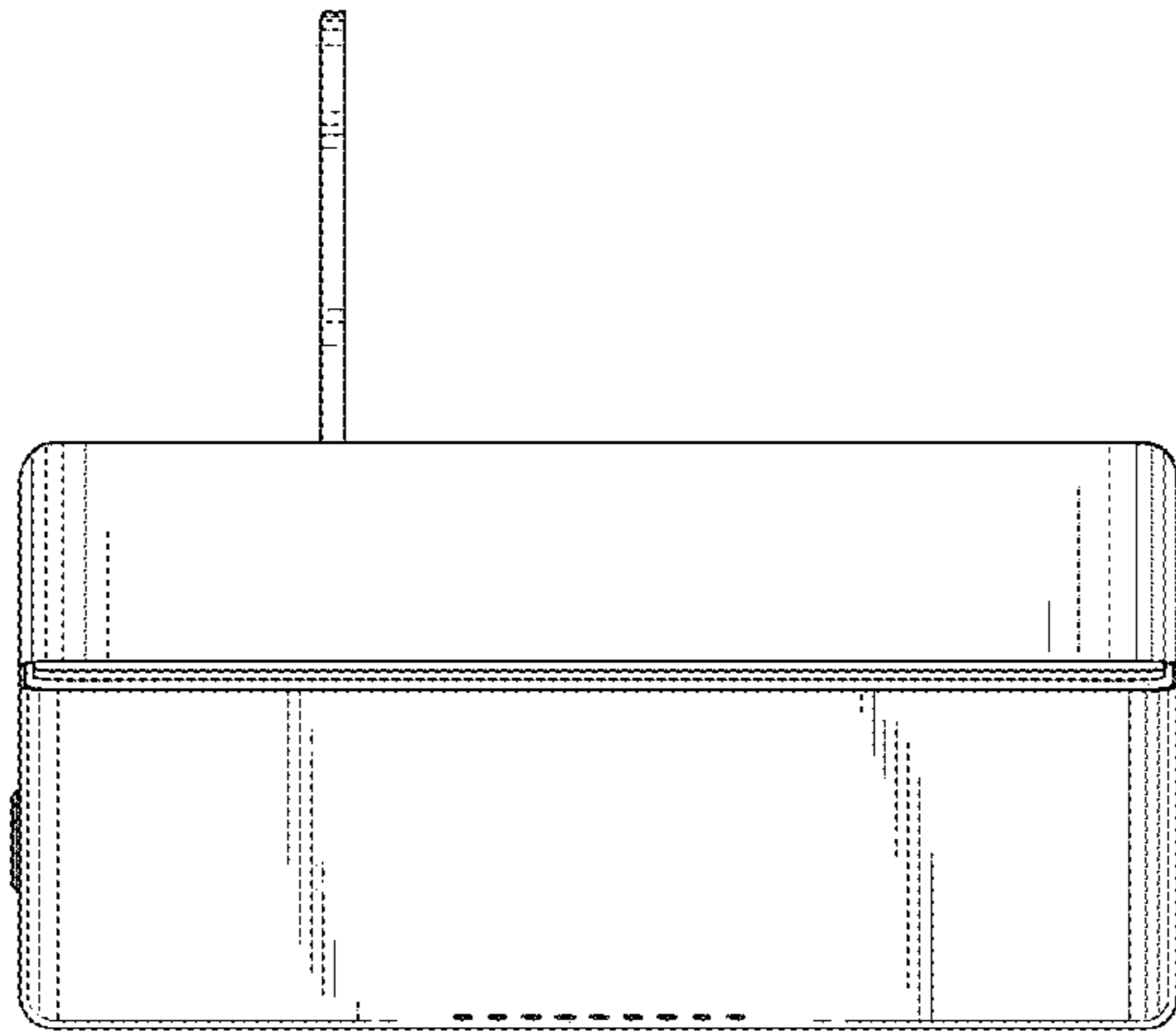

FIG.19

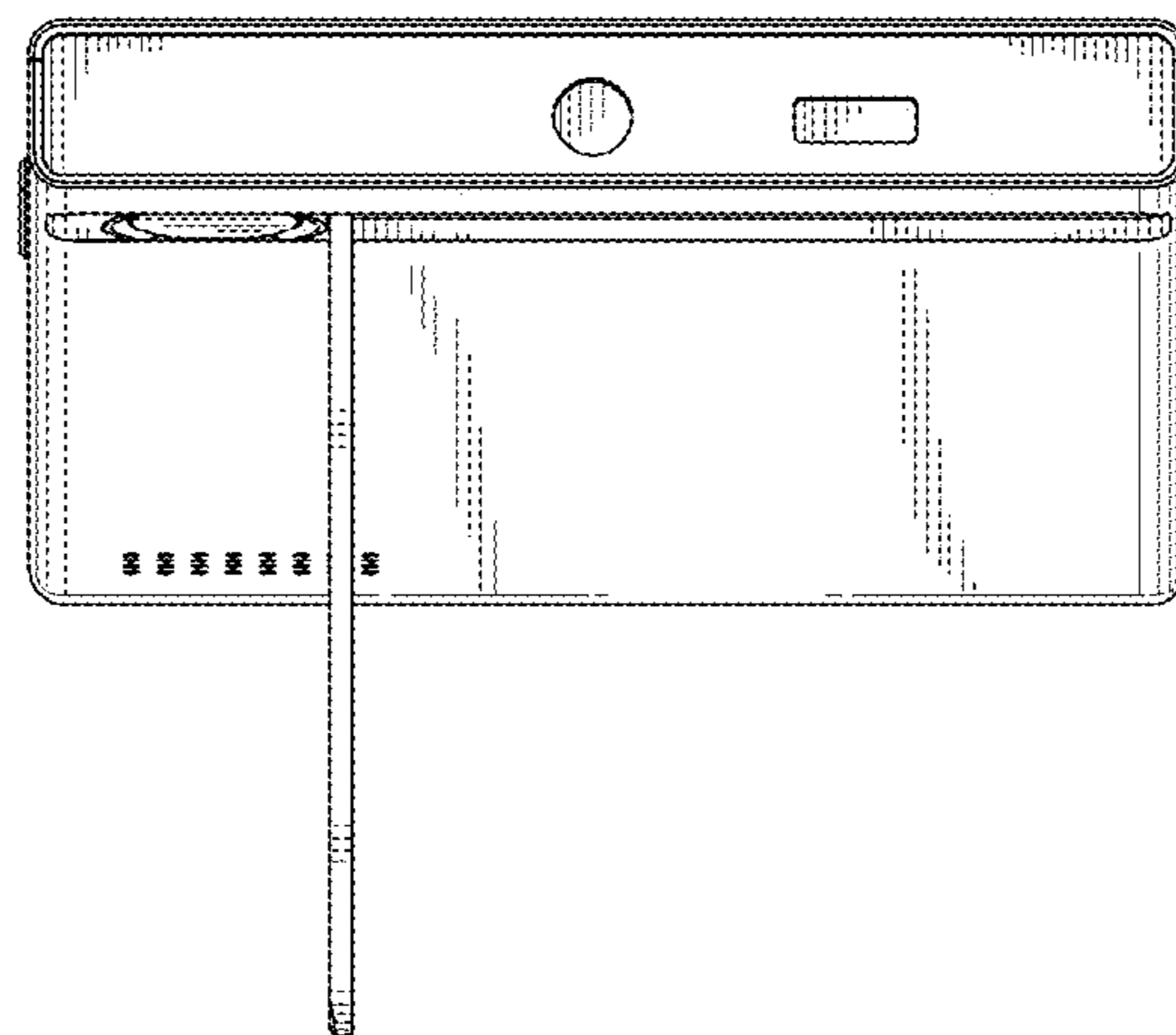

FIG.20

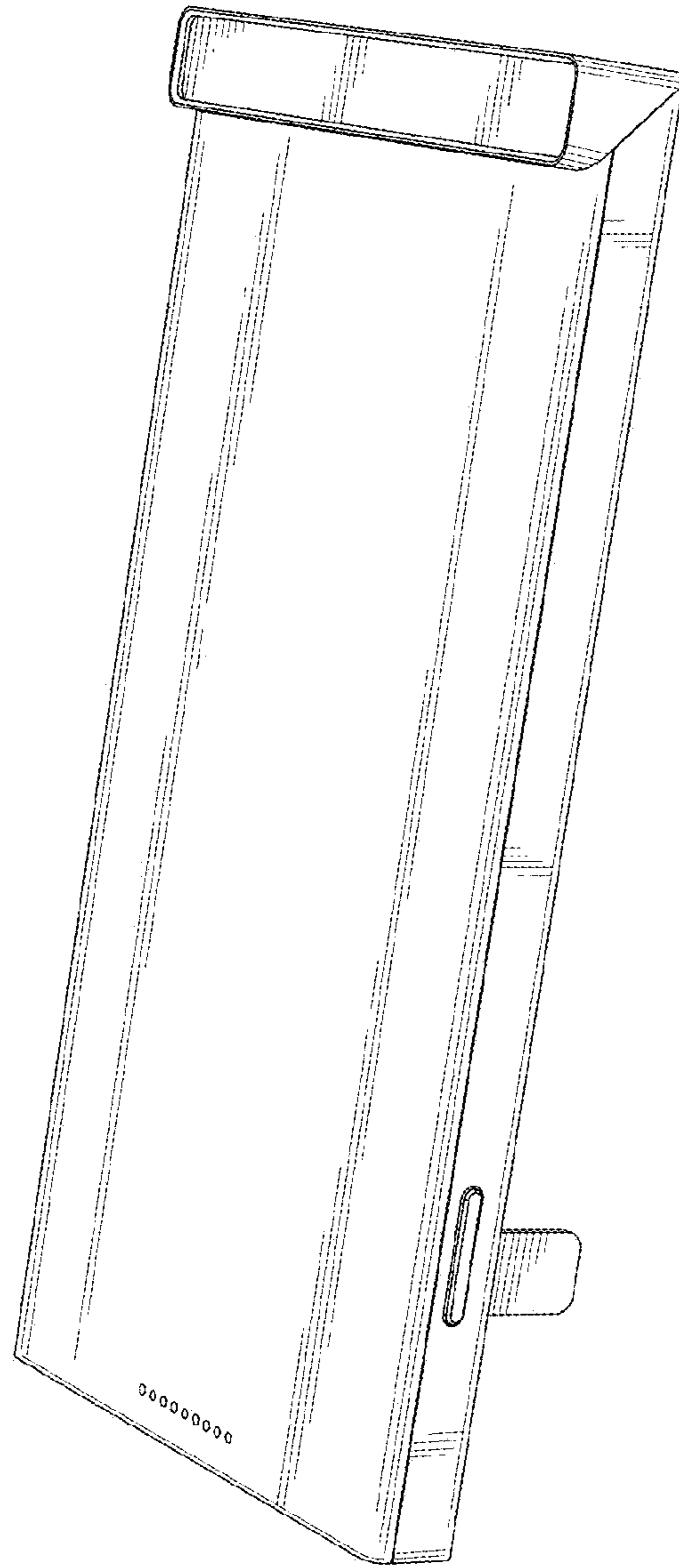

FIG.21

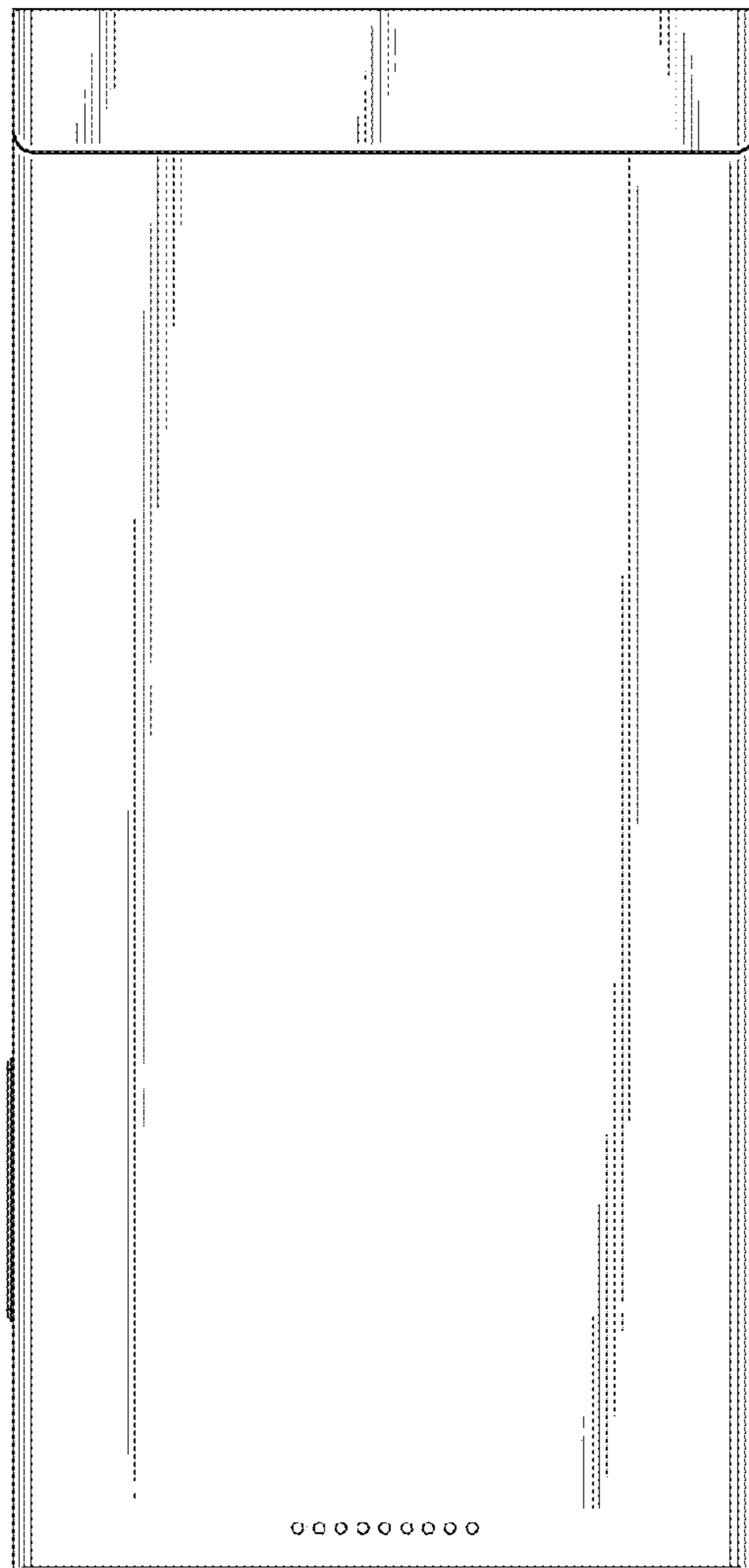

FIG.22

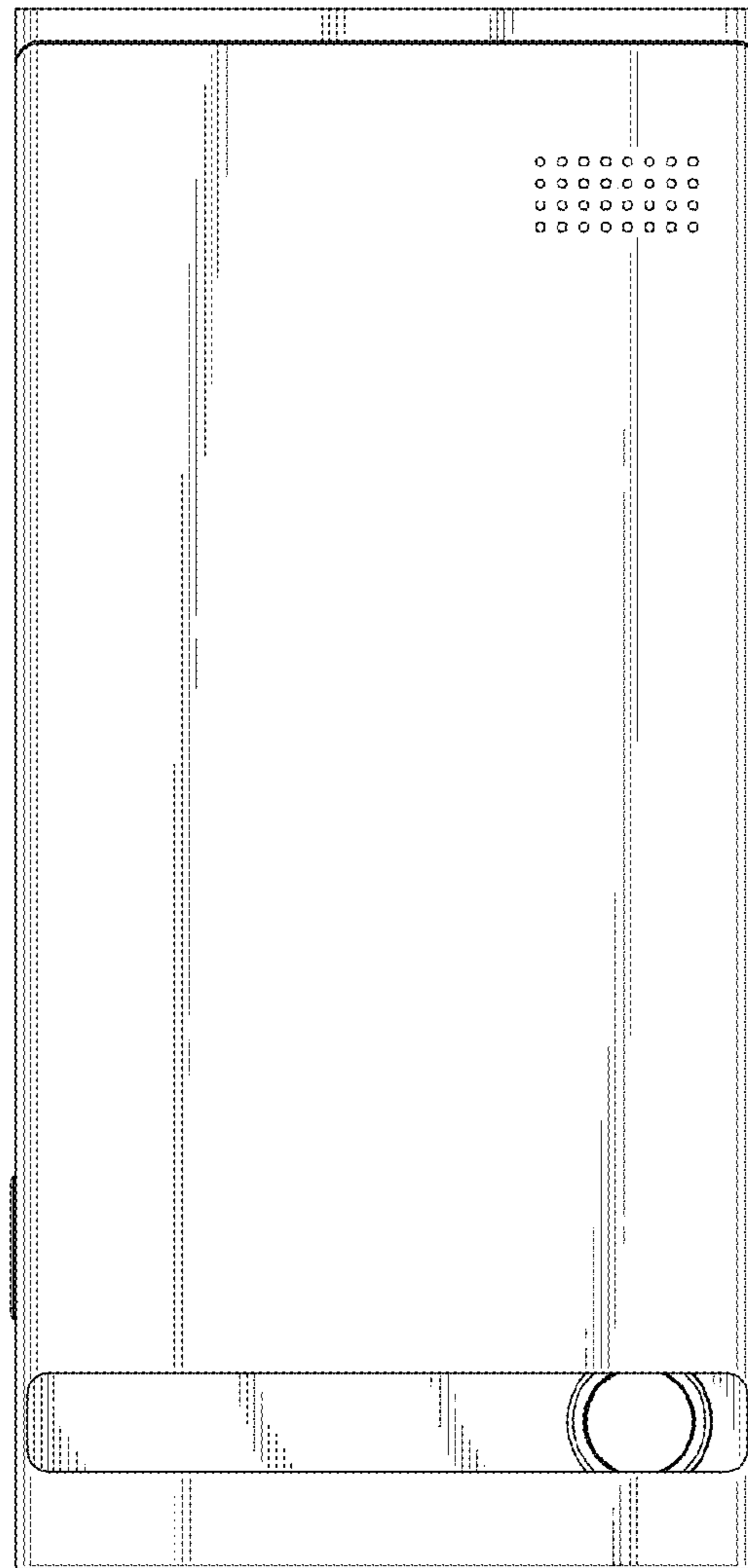

FIG.23

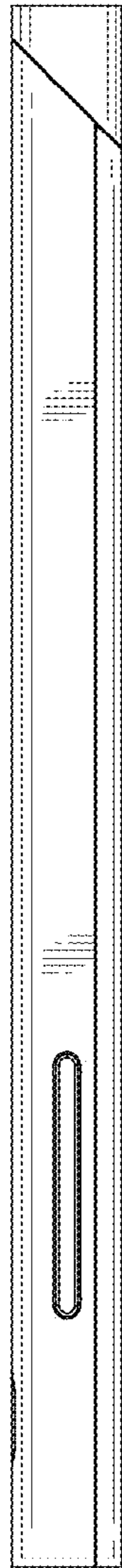

FIG.24

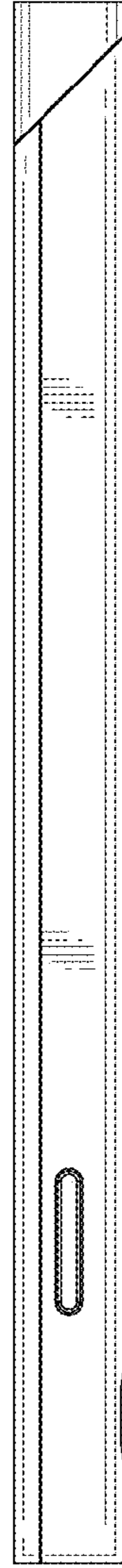

FIG.25



FIG.26

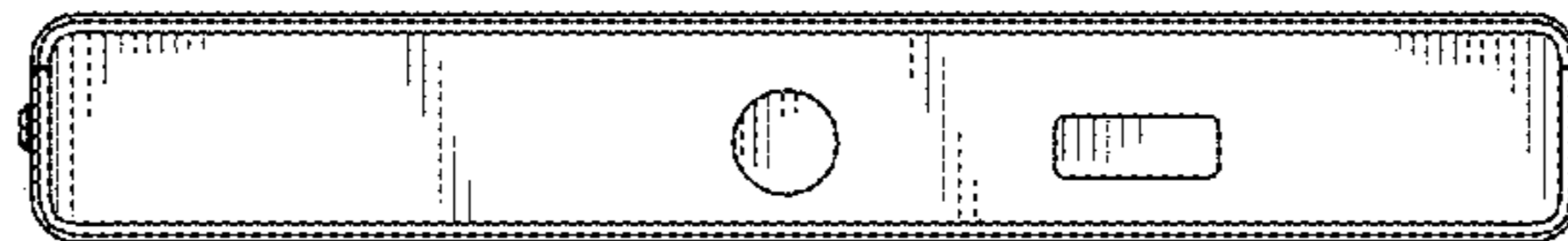

FIG.27

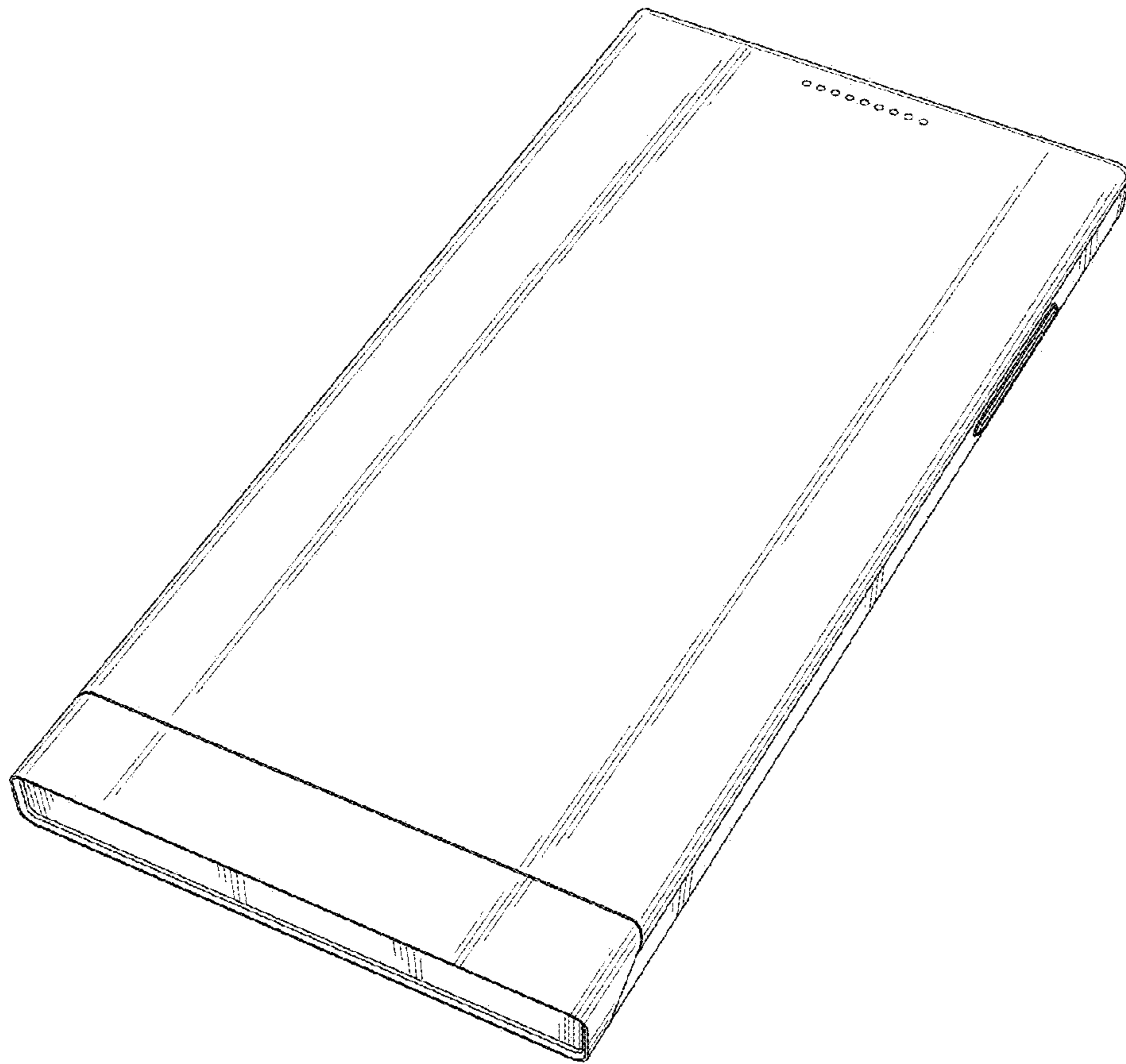

FIG.28