

US00D752891S

(12) **United States Design Patent**  
**Kubryk**

(10) **Patent No.:** **US D752,891 S**

(45) **Date of Patent:** **\*\* Apr. 5, 2016**

(54) **STACKING CHAIR**

(71) Applicant: **Isaac Kubryk**, Lockeford, CA (US)

(72) Inventor: **Isaac Kubryk**, Lockeford, CA (US)

(73) Assignee: **Global Allies**, Lockeford, CA (US)

(\*\*) Term: **14 Years**

(21) Appl. No.: **29/522,537**

(22) Filed: **Mar. 31, 2015**

(51) **LOC (10) Cl.** ..... **06-01**

(52) **U.S. Cl.**  
USPC ..... **D6/370**

(58) **Field of Classification Search**  
USPC ..... D6/334–336, 368, 370, 376, 379, 380,  
D6/716, 716.1, 716.3, 716.4  
CPC ..... A47C 3/04; A47C 4/02; A47C 4/03;  
A47C 4/024; A47C 4/028; A47C 5/04;  
A47C 5/06; A47C 7/16  
See application file for complete search history.

(56) **References Cited**

**U.S. PATENT DOCUMENTS**

D102,695 S \* 1/1937 McLellan ..... D6/370  
D102,978 S \* 2/1937 Baum ..... D6/370

D497,490 S \* 10/2004 Socha, Jr. .... D6/370  
D513,455 S \* 1/2006 Risdon ..... D6/370  
D617,108 S \* 6/2010 Niermeyer ..... D6/368  
D680,767 S \* 4/2013 Blumenthal ..... D6/368  
D713,648 S \* 9/2014 Gregson ..... D6/370  
D713,649 S \* 9/2014 Gregson ..... D6/370  
D734,970 S \* 7/2015 Mulholland ..... D6/370

\* cited by examiner

*Primary Examiner* — Mimoso De

(74) *Attorney, Agent, or Firm* — Audrey A. Millemann;  
Weintraub Tobin

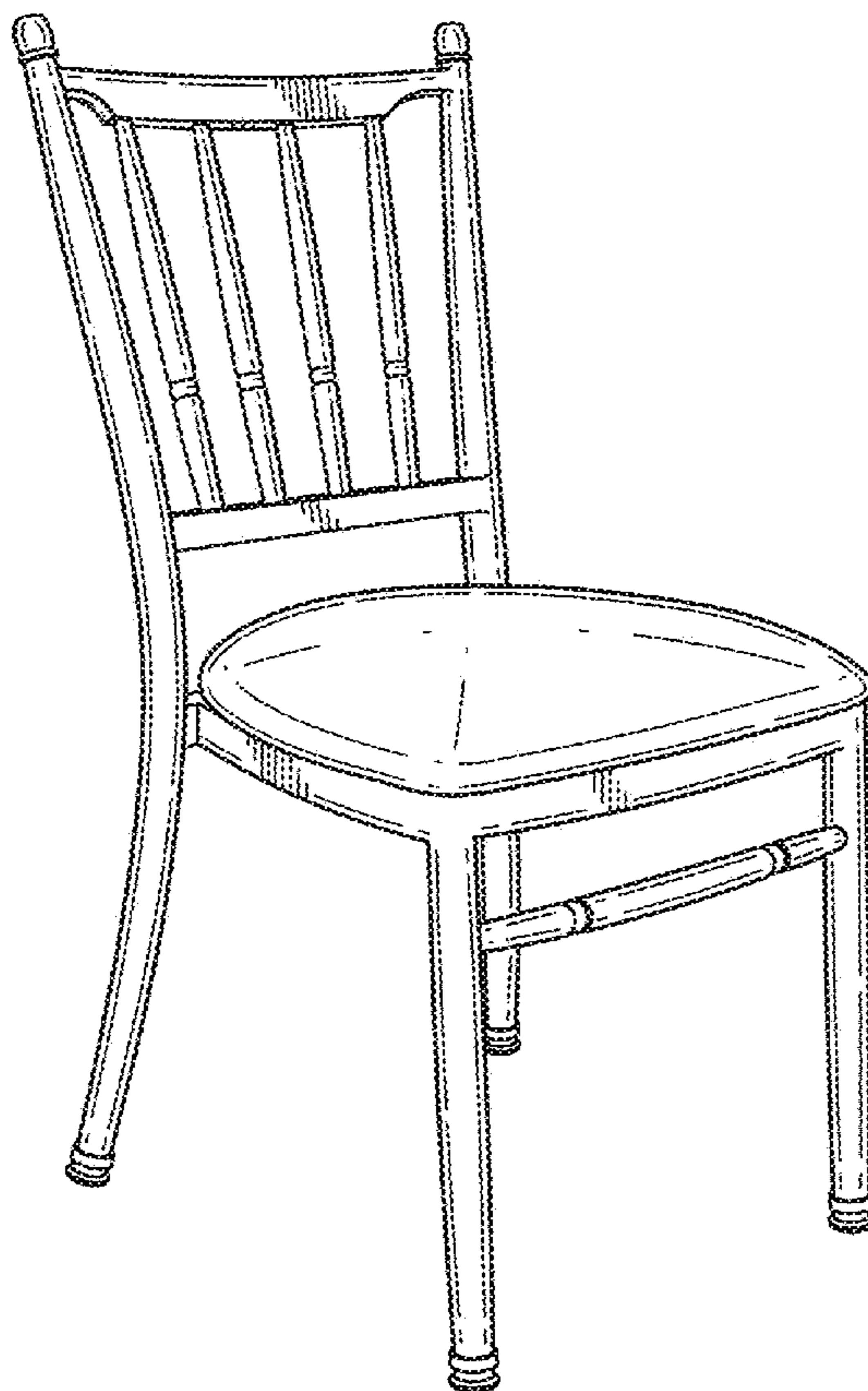
(57) **CLAIM**

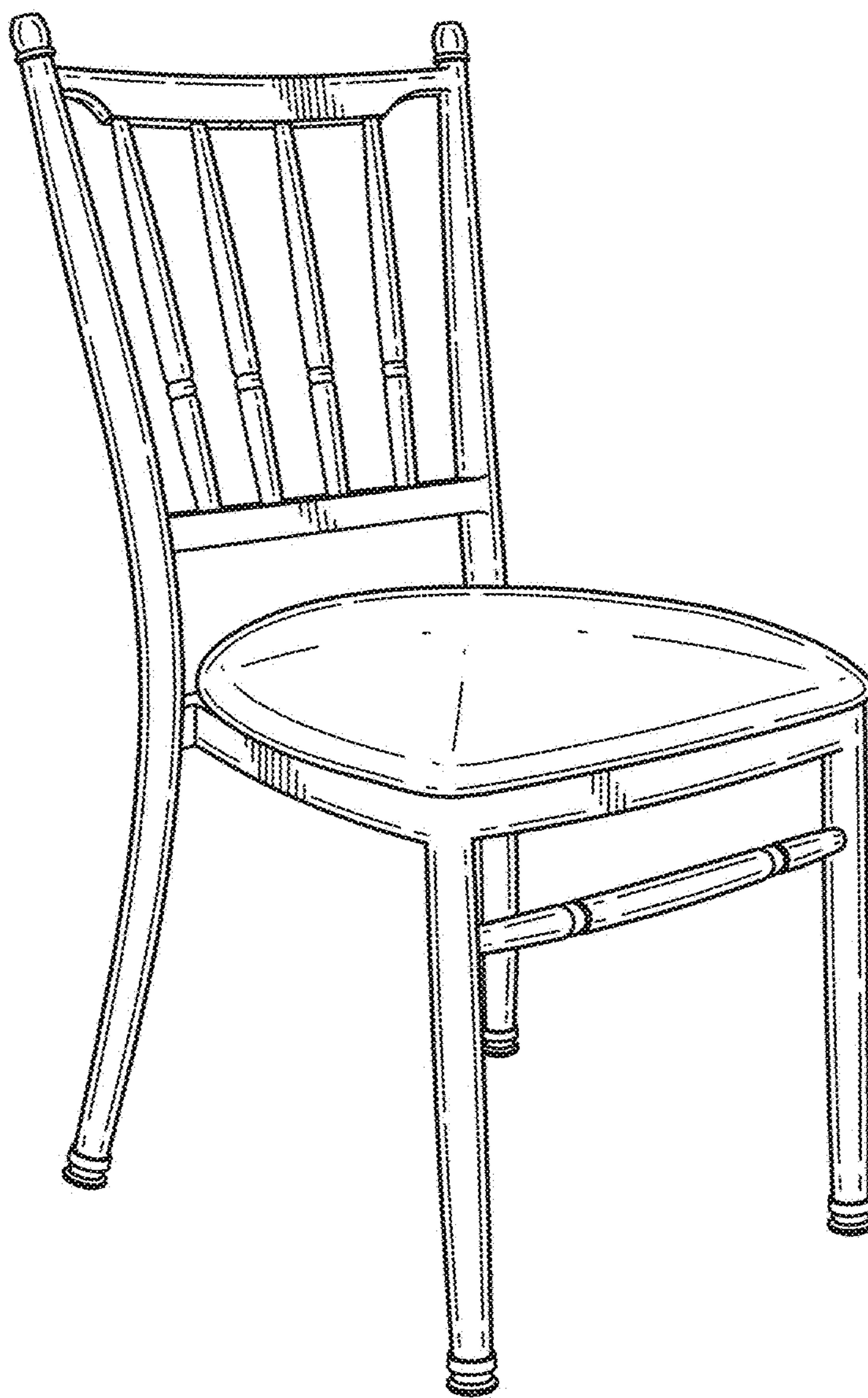
The ornamental design for a stacking chair, as shown and described.

**DESCRIPTION**

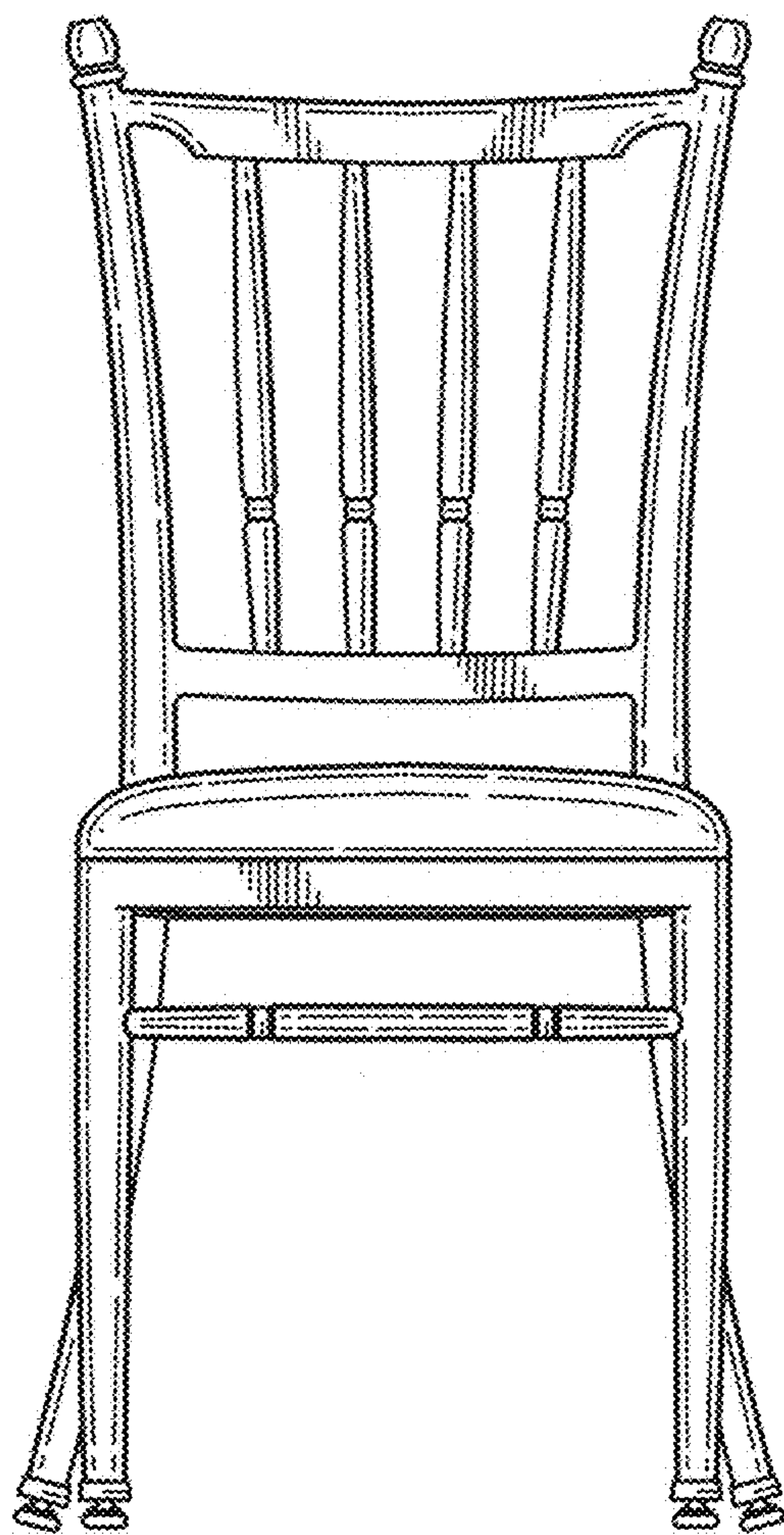
FIG. 1 is a perspective view of a stacking chair, looking toward the right front corner, showing my new design; FIG. 2 is a front view thereof; FIG. 3 is a right side view thereof; FIG. 4 is a back view thereof; FIG. 5 is a top view thereof; and, FIG. 6 is a bottom view thereof.

**1 Claim, 5 Drawing Sheets**

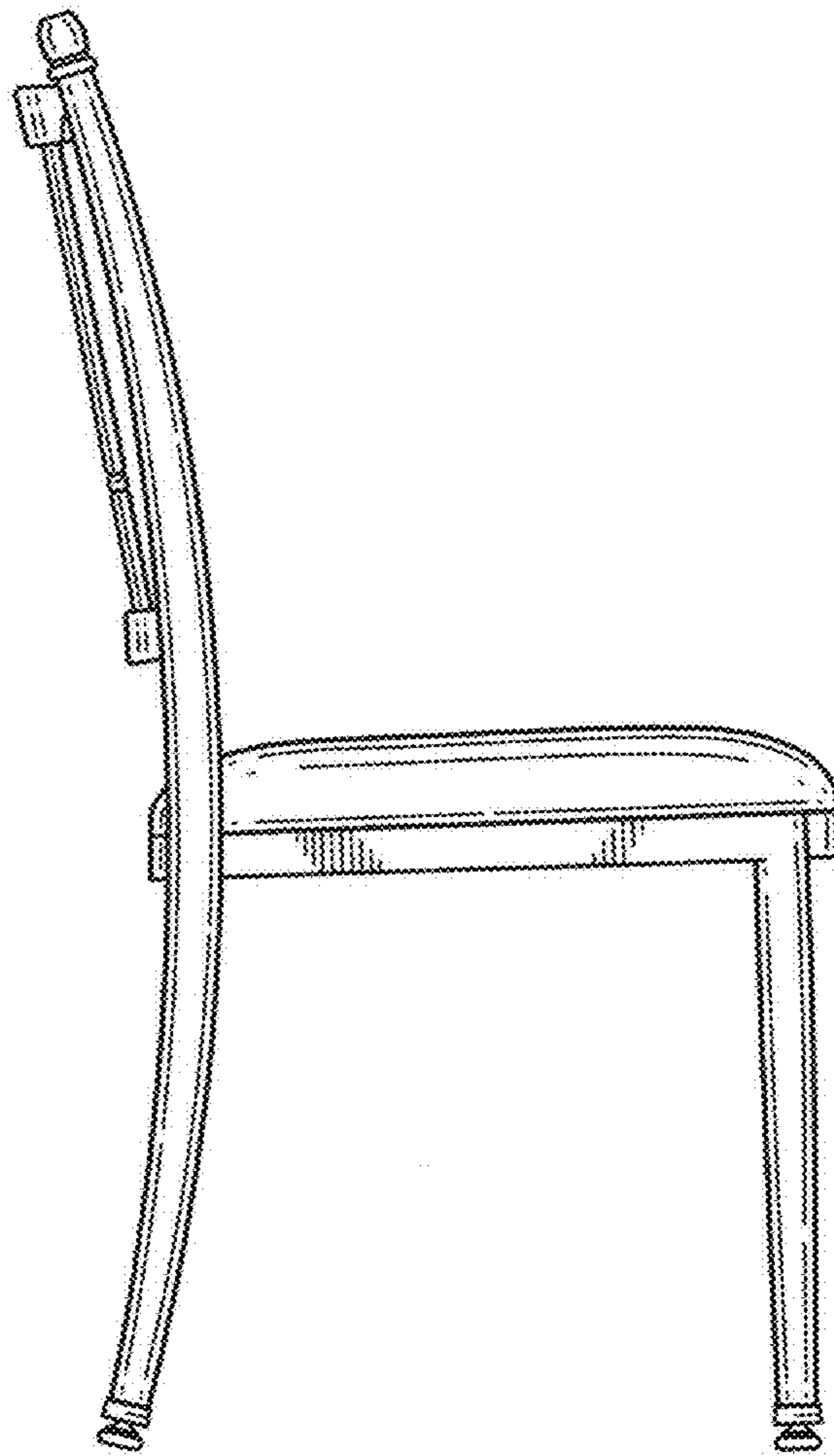




**FIG. 1**

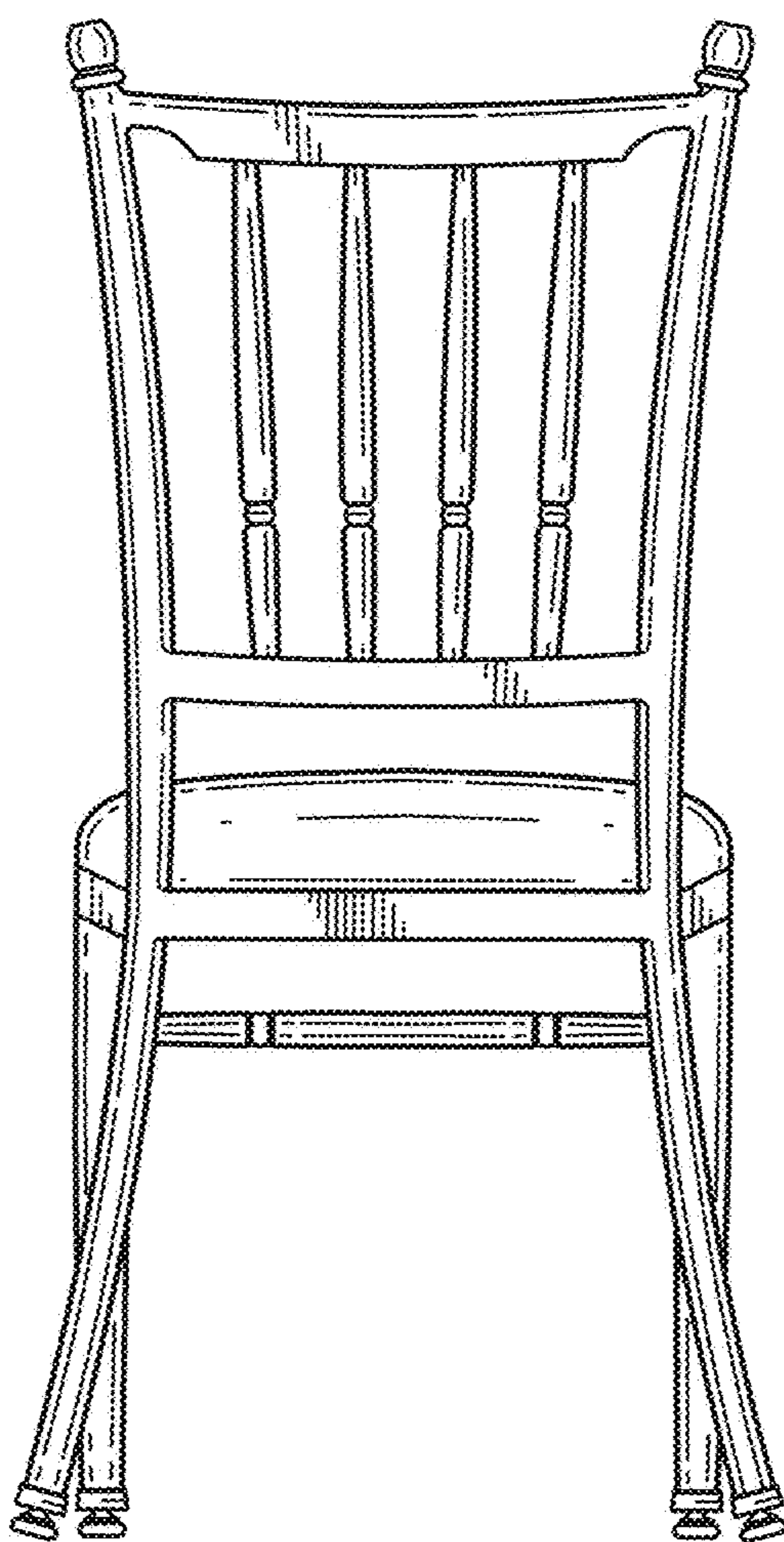


**FIG. 2**

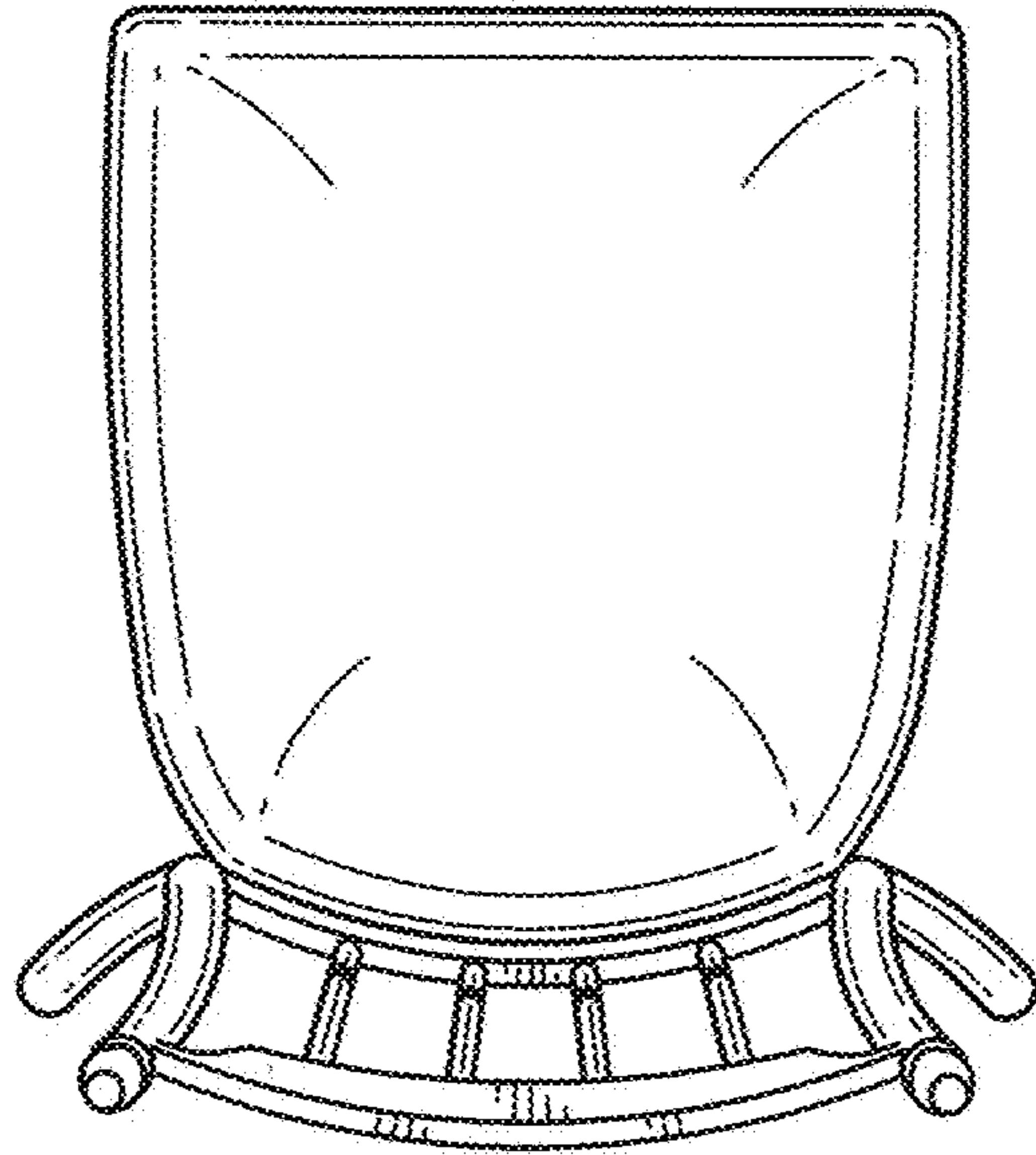


*FIG. 3*

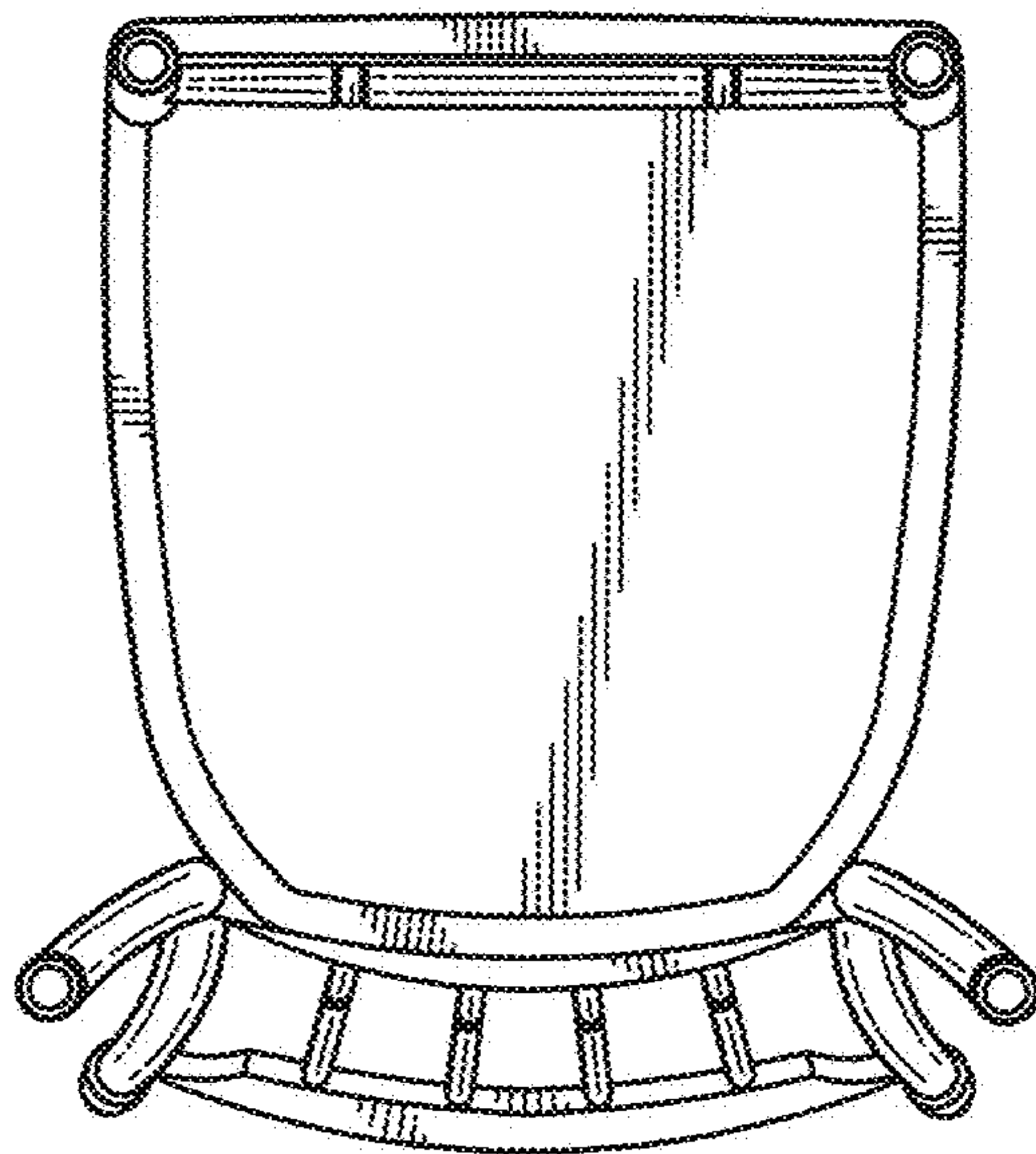




**FIG. 4**



**FIG. 5**



**FIG. 6**