



US00D752857S

(12) **United States Design Patent**
Morgan et al.

(10) **Patent No.:** **US D752,857 S**
(45) **Date of Patent:** **** Apr. 5, 2016**

(54) **PORTABLE ELECTRONIC DEVICE CARRIER**

Primary Examiner — Catheri Oliver-Garcia
(74) *Attorney, Agent, or Firm* — Marshall, Gerstein & Borun LLP

(71) Applicant: **ARMPOCKET ENTERPRISES,**
Miramar, FL (US)

(72) Inventors: **Mark Edward Morgan,** Doral, FL (US); **Jytte Lilli Nielsen,** Doral, FL (US)

(57) **CLAIM**

We claim the ornamental design for a portable electronic device carrier, as shown and described.

(73) Assignee: **ARMPOCKET ENTERPRISES,**
Miramar, FL (US)

(**) Term: **14 Years**

DESCRIPTION

(21) Appl. No.: **29/489,470**

(22) Filed: **Apr. 30, 2014**

(51) **LOC (10) Cl.** **03-01**

(52) **U.S. Cl.**
USPC **D3/218**

(58) **Field of Classification Search**
USPC D3/226, 218–219, 215; 224/267, 269, 224/197, 221, 250, 575, 930, 664, 667, 669, 224/676–677, 219, 222; 455/575.1–575.8
See application file for complete search history.

FIG. 1 is an isometric view of a first embodiment of a portable electronic device carrier showing the new design; FIG. 2 is a front elevation view thereof; FIG. 3 is a rear elevation view thereof; FIG. 4 is a left side elevation view thereof; FIG. 5 is a right side elevation view thereof; FIG. 6 is a bottom plan view thereof; FIG. 7 is a top plan view thereof; FIG. 8 is an isometric view of a second embodiment of a portable electronic device carrier; FIG. 9 is a front elevation view thereof; FIG. 10 is a rear elevation view thereof; FIG. 11 is a left side elevation view thereof; FIG. 12 is a right side elevation view thereof; FIG. 13 is a bottom plan view thereof; and, FIG. 14 is a top plan view thereof.
The broken lines are intended to depict environmental subject matter (such as stitching and a zipper) and form no part of the claimed design. The lining of the center window represents a transparent surface. Any parts of the portable electronic device carrier that are hidden from view or that are not clearly disclosed in the drawings are not part of the claimed design.

(56) **References Cited**

U.S. PATENT DOCUMENTS

6,568,574 B2 *	5/2003	Jones	A45C 1/04 224/219
D576,792 S *	9/2008	Wagner, II	D3/226
D620,706 S *	8/2010	Wagner, II	D3/226
D651,793 S *	1/2012	Willows	D3/226
D681,945 S *	5/2013	Willows	D3/226
8,474,669 B2 *	7/2013	Rohrbach	A45F 5/00 224/222
D710,598 S *	8/2014	Morgan	D3/226

* cited by examiner

1 Claim, 6 Drawing Sheets

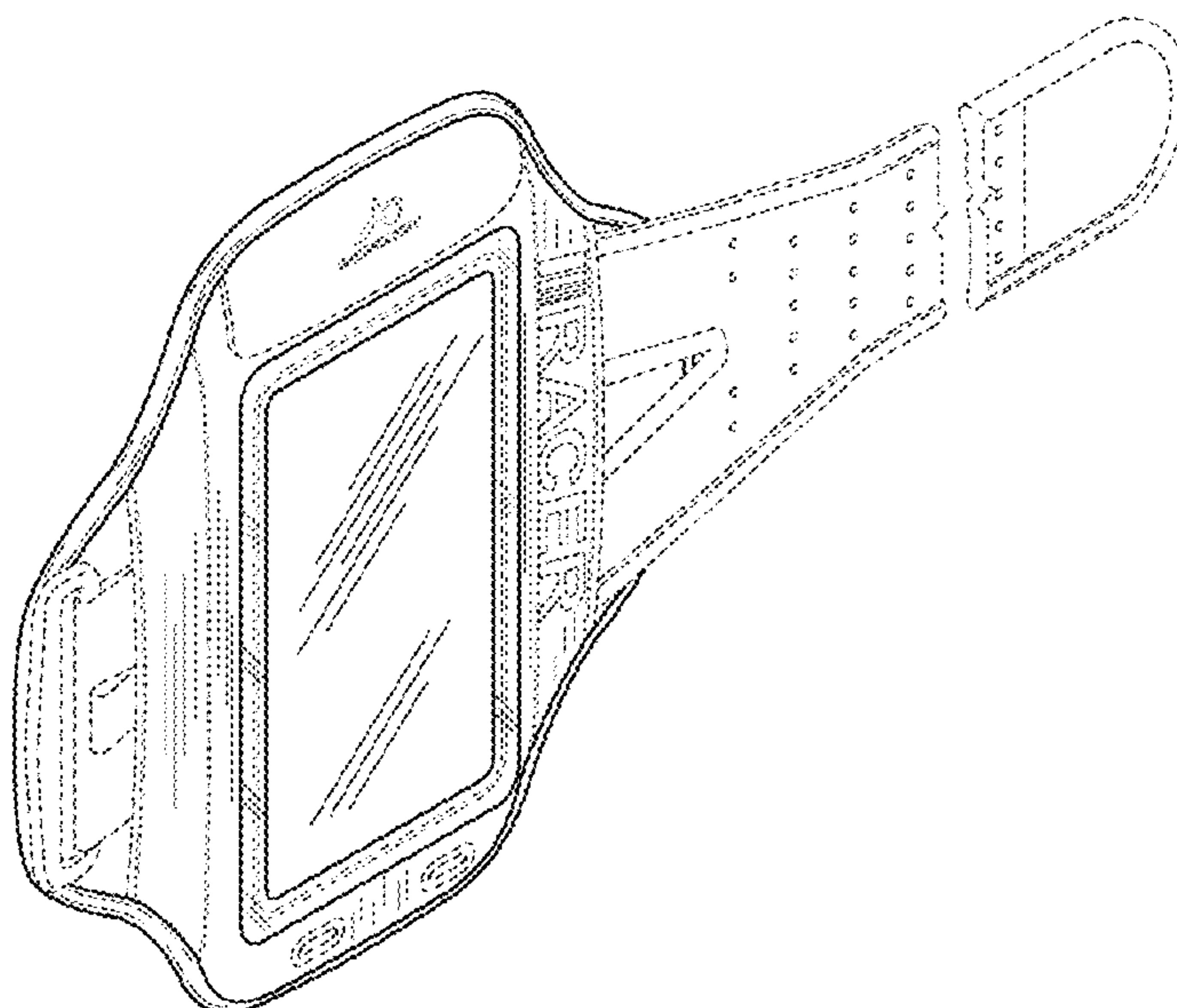

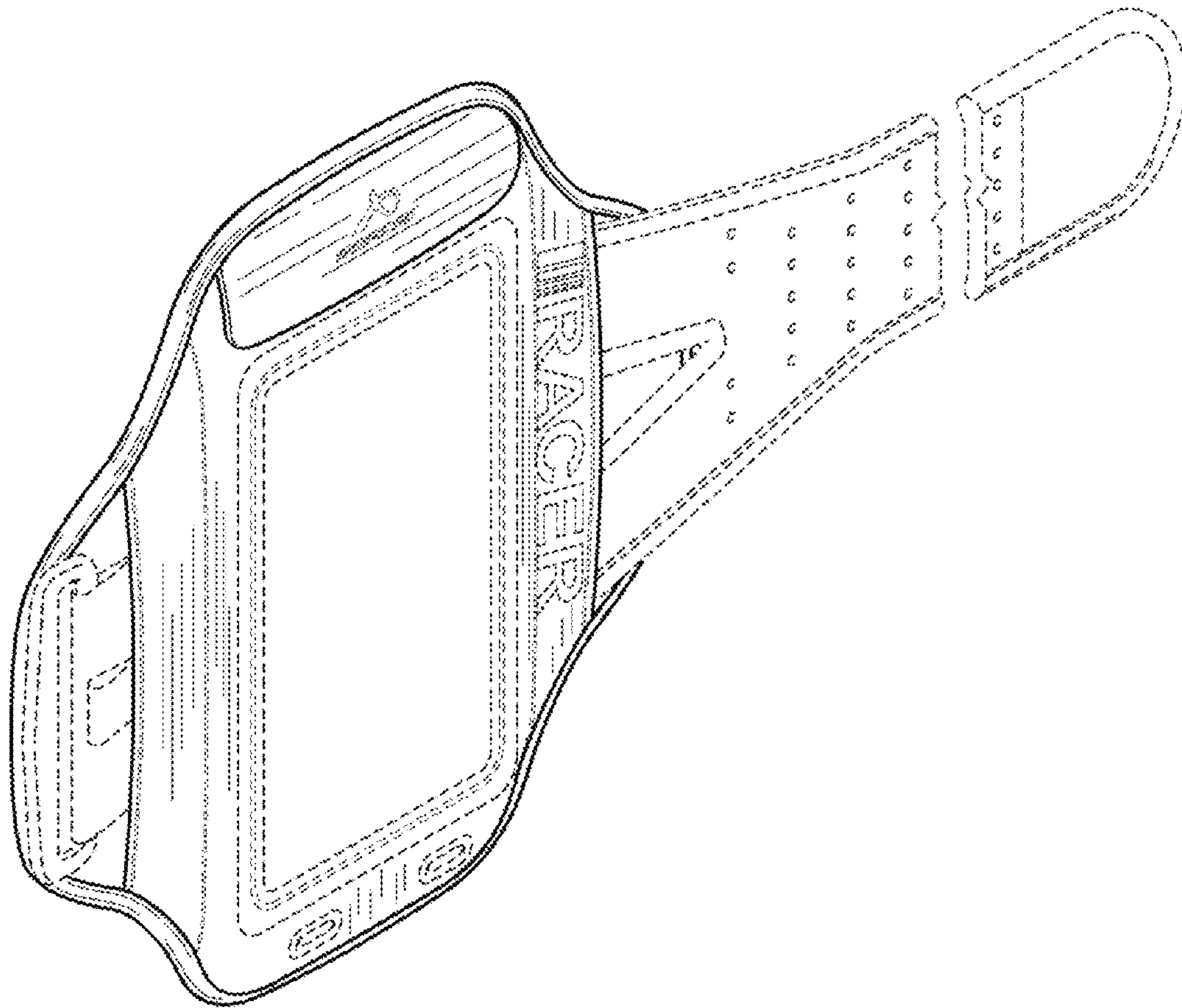

Fig. 1

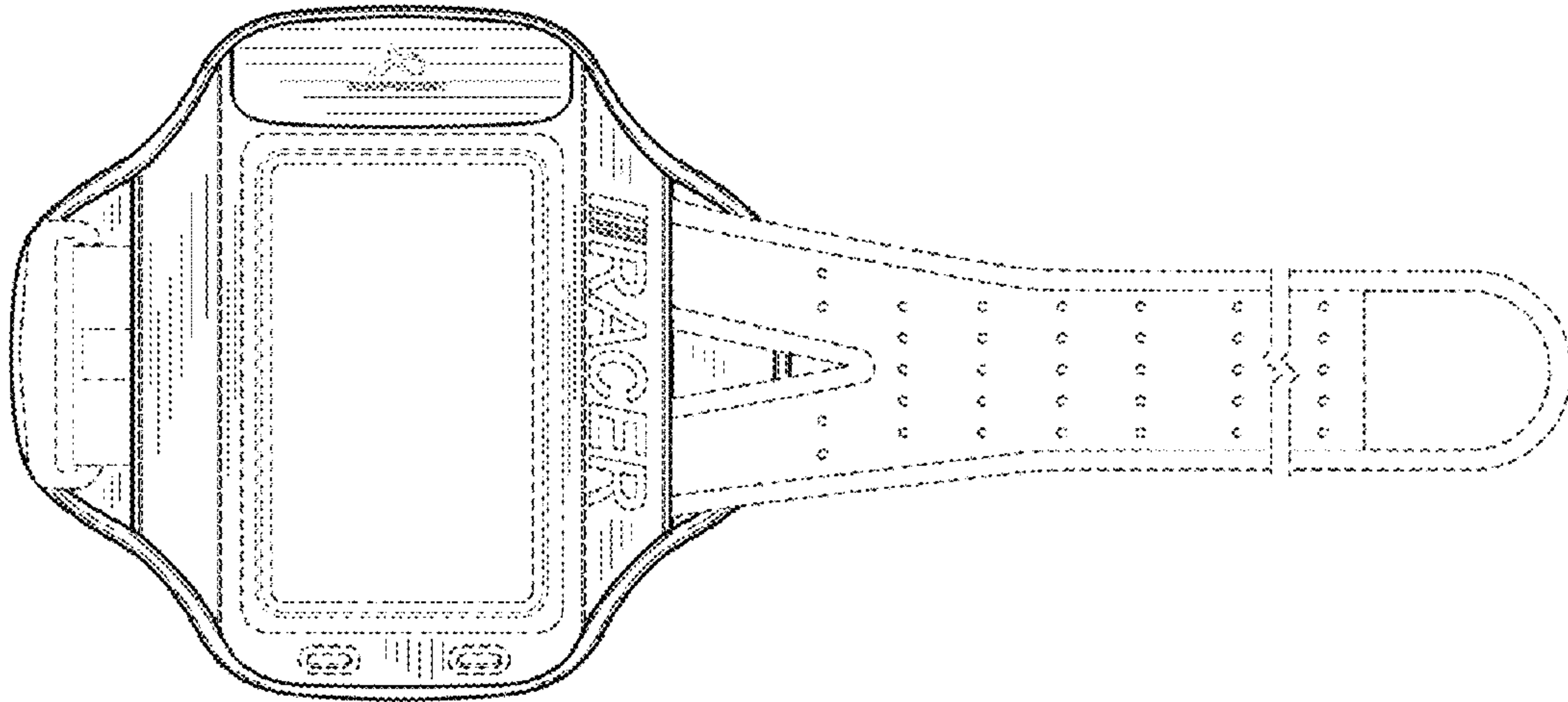

Fig. 2

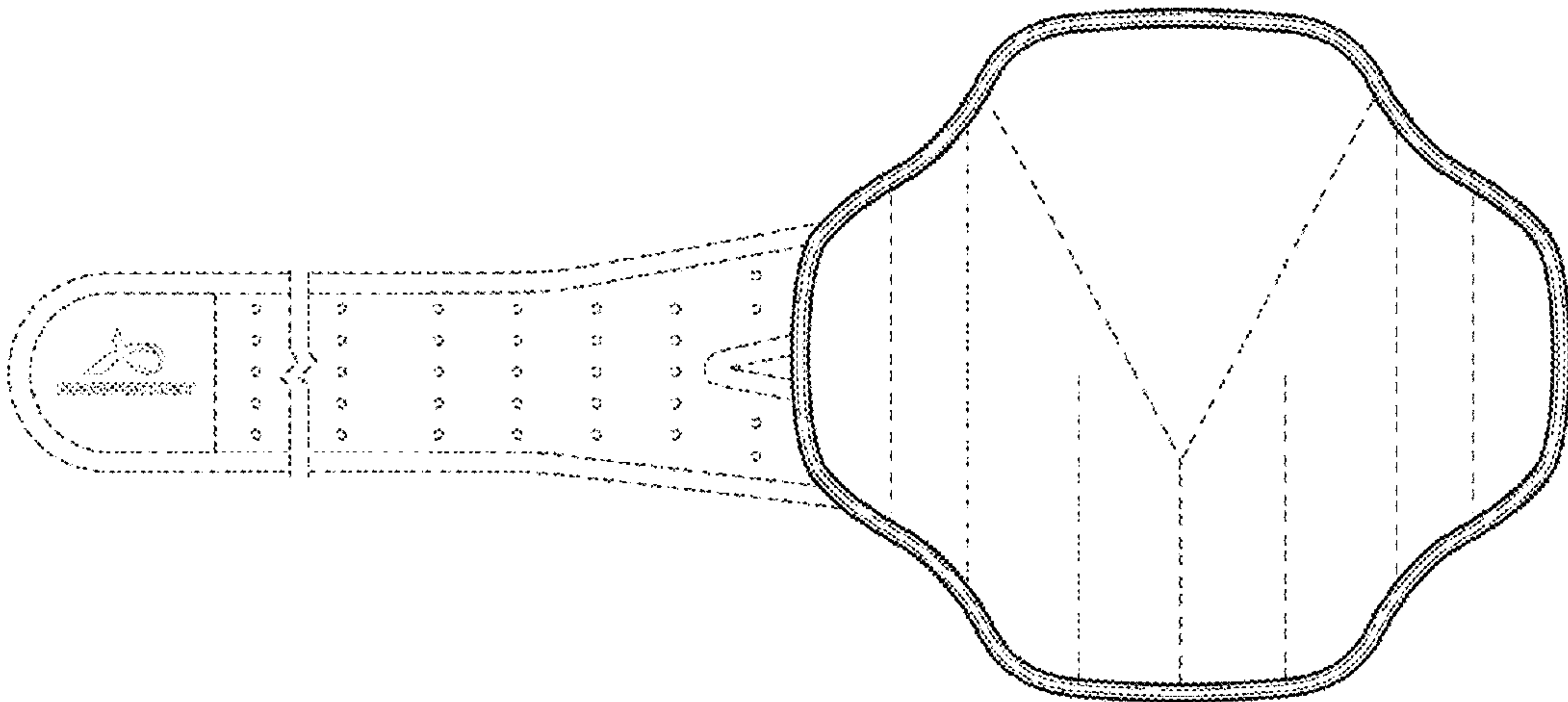

Fig. 3

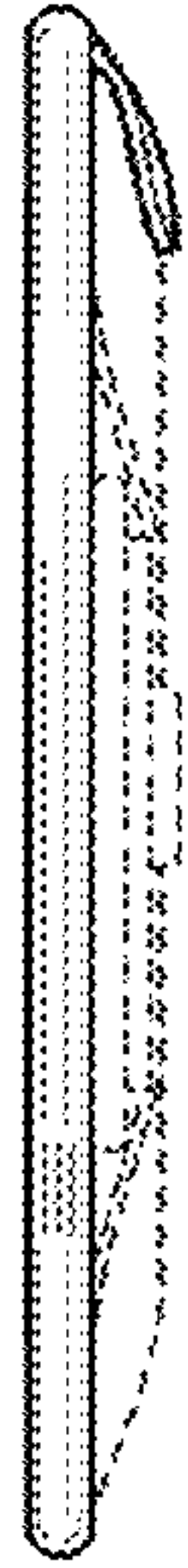

Fig. 4

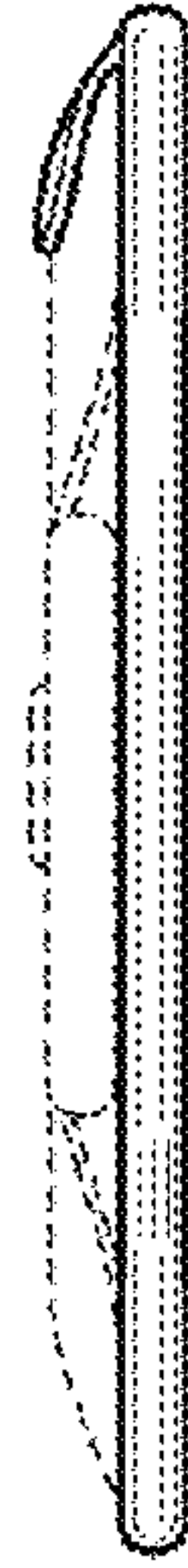

Fig. 5

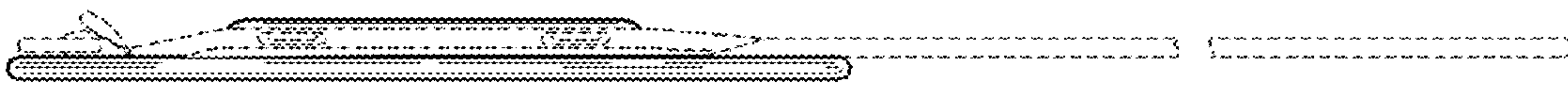

Fig. 6

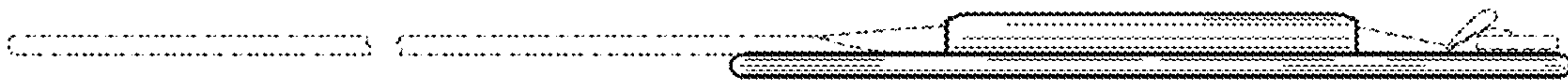

Fig. 7

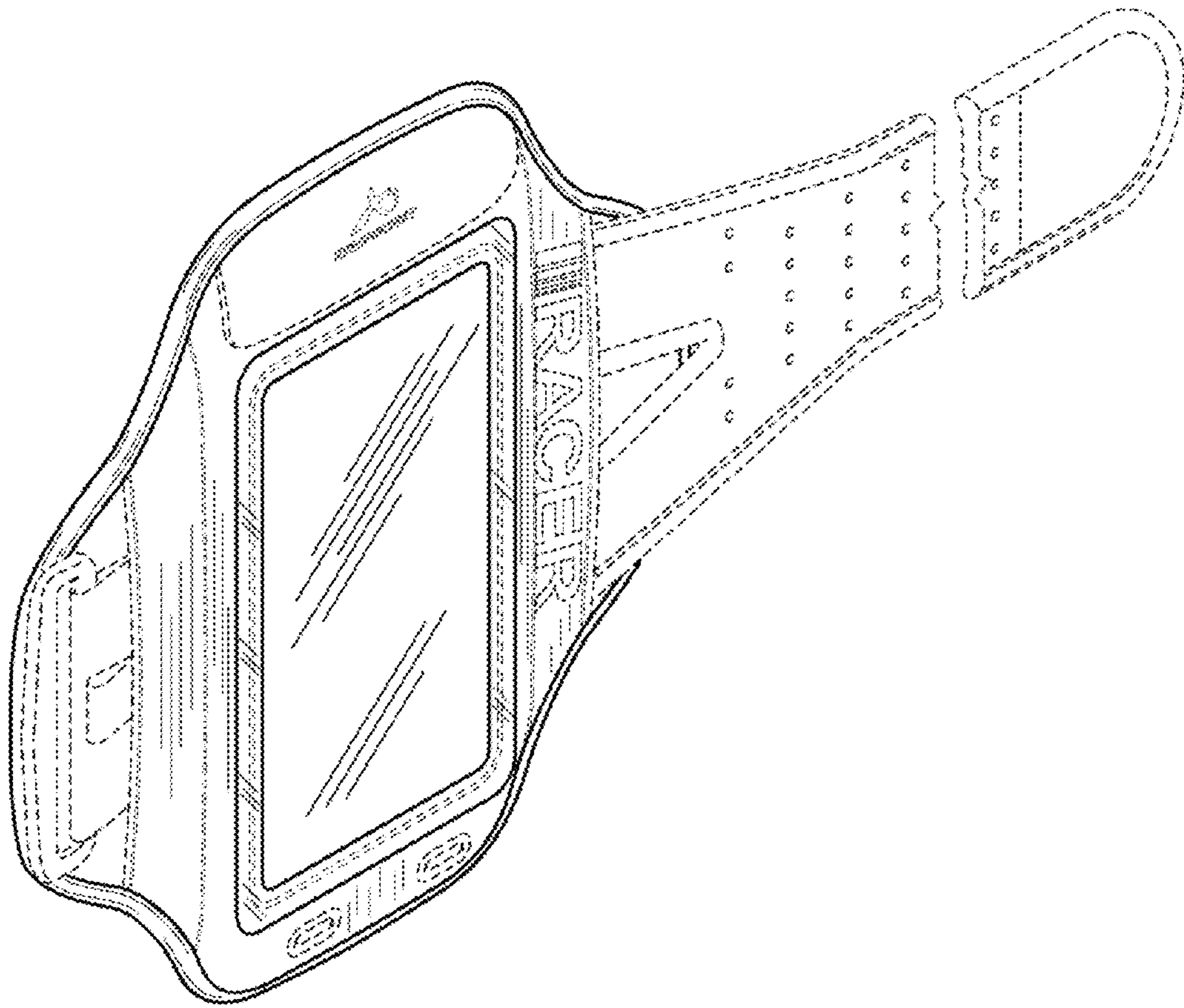

Fig. 8

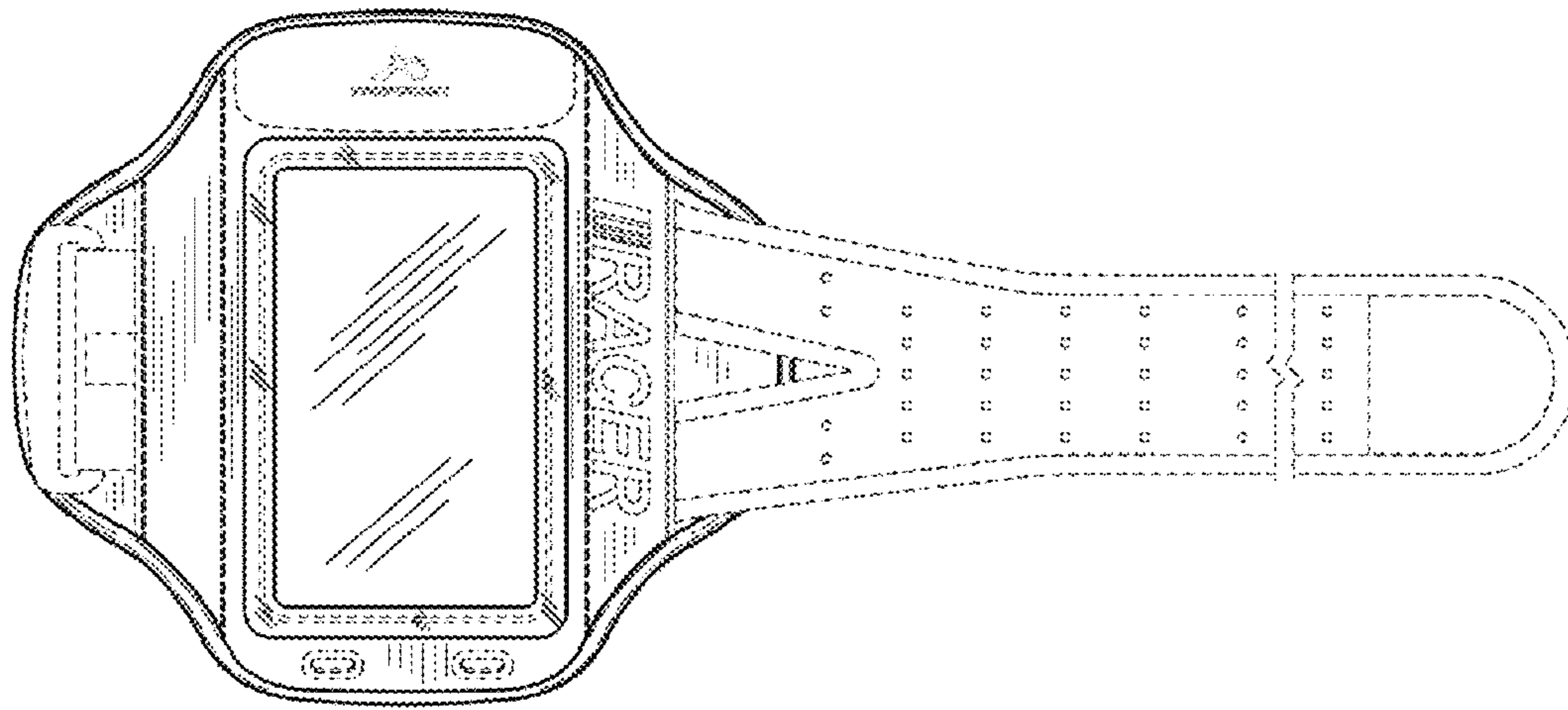

Fig. 9

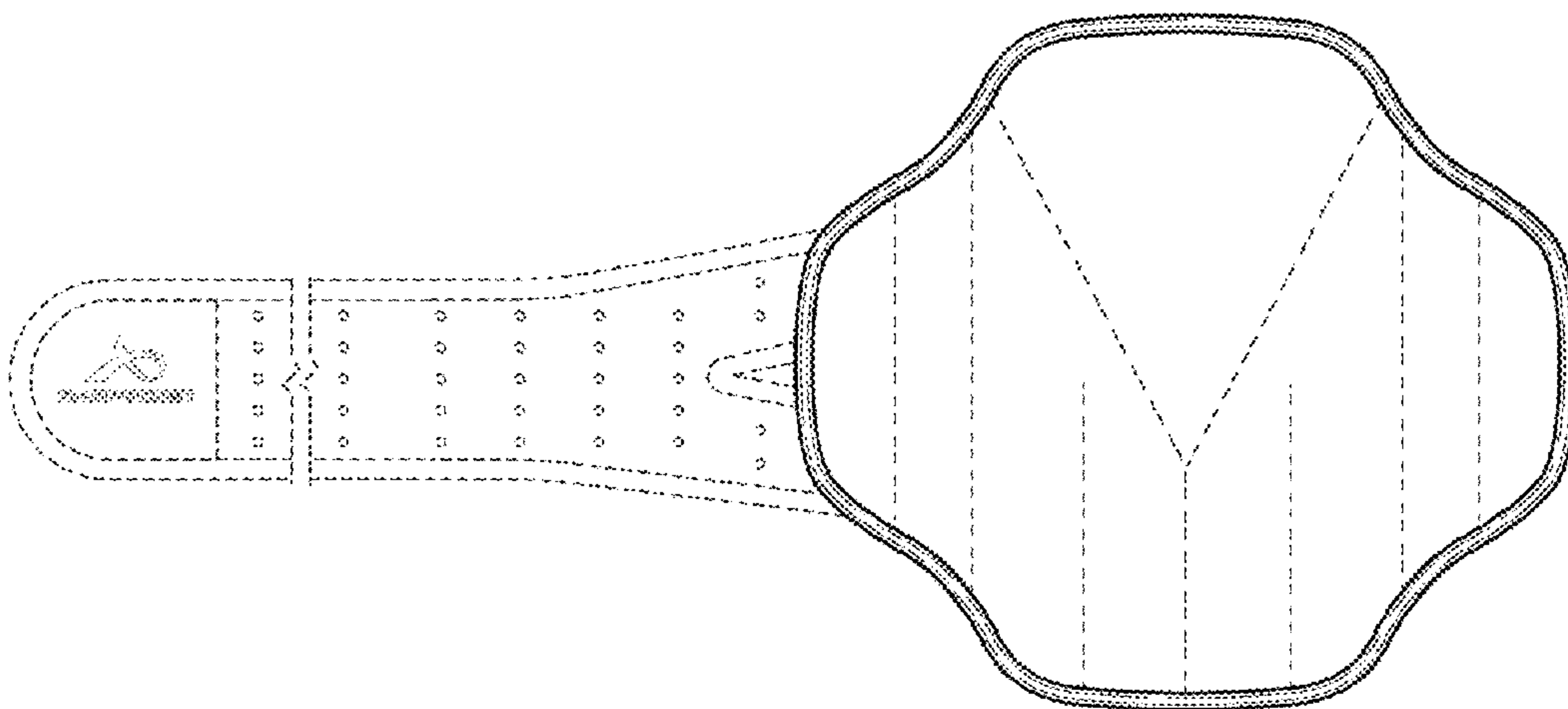

Fig. 10



Fig. 11

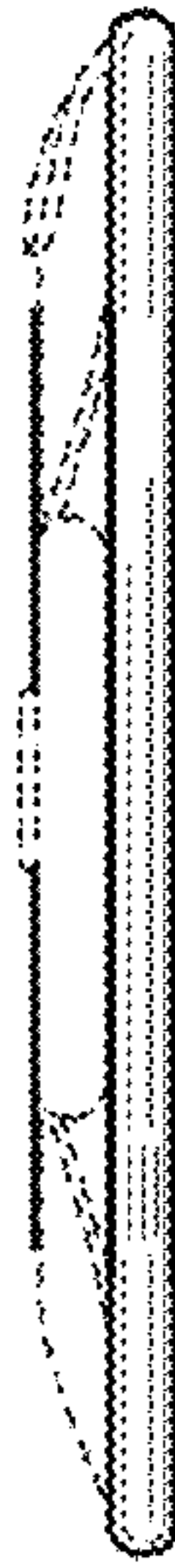

Fig. 12

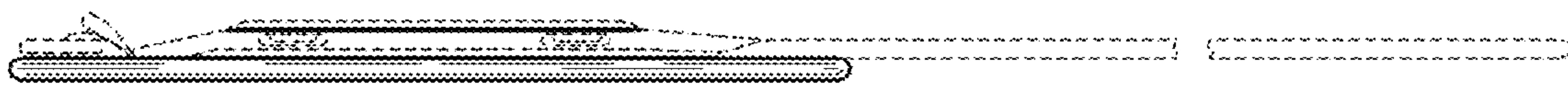

Fig. 13

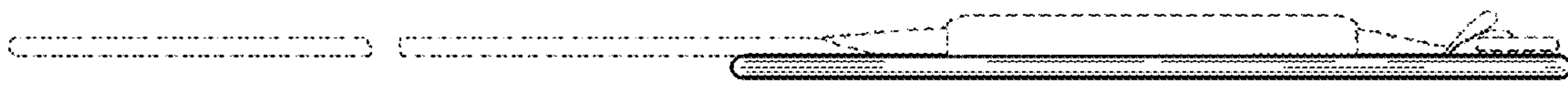

Fig. 14