

US00D752823S

(12) **United States Design Patent**
Bologna

(10) **Patent No.:** **US D752,823 S**
(45) **Date of Patent:** **** Mar. 29, 2016**

(54) **FOOTBALL HELMET**

(71) Applicant: **Riddell, Inc.**, Rosemont, IL (US)

(72) Inventor: **Vittorio Bologna**, Elk Grove Village, IL (US)

(73) Assignee: **Ridell, Inc.**, Rosemont, IL (US)

(**) Term: **14 Years**

(21) Appl. No.: **29/481,988**

(22) Filed: **Feb. 12, 2014**

(51) **LOC (10) Cl.** **29-02**

(52) **U.S. Cl.**
USPC **D29/122**

(58) **Field of Classification Search**

USPC D29/102-107, 122
CPC A42B 1/066; A42B 3/228; A42B 3/08;
A42B 3/32; A42B 3/00; A42B 3/166; A42B
3/222; A42B 3/16; A42B 3/20; A42B 3/227;
A42B 3/105; A42B 3/22; A42B 3/04; A42B
3/06; A63B 71/10

See application file for complete search history.

(56) **References Cited**

U.S. PATENT DOCUMENTS

2,140,716 A 12/1938 Pryale
2,969,546 A 1/1961 Morgan, Jr.
3,166,761 A 1/1965 Strohm
3,186,004 A 6/1965 Carlini
3,548,409 A 12/1970 Aileo
3,761,959 A 10/1973 Dunning
3,882,547 A 5/1975 Morgan
4,233,687 A 11/1980 Lancellotti

4,287,613 A 9/1981 Schulz
D267,287 S 12/1982 Gooding
4,370,759 A 2/1983 Zide
4,404,690 A 9/1983 Farquharson
D271,249 S 11/1983 Farquharson

(Continued)

OTHER PUBLICATIONS

U.S. Appl. No. 29/453,426, filed Apr. 29, 2013, Bologna, Vittorio.

Primary Examiner — Ruth McInroy

(74) *Attorney, Agent, or Firm* — McDermott Will & Emery LLP

(57) **CLAIM**

I claim the ornamental design for a football helmet, as shown and described.

DESCRIPTION

FIG. 1 is a perspective view of a first embodiment of a football helmet;

FIG. 2 is a left side view of the helmet of FIG. 1;

FIG. 3 is a right side view of the helmet of FIG. 1;

FIG. 4 is a rear view of the helmet of FIG. 1;

FIG. 5 is a top view of the helmet of FIG. 1;

FIG. 6 is a bottom view of the helmet of FIG. 1;

FIG. 7 is a perspective view of a second embodiment of the football helmet;

FIG. 8 is a left side view of the helmet of FIG. 7;

FIG. 9 is a right side view of the helmet of FIG. 7;

FIG. 10 is a rear view of the helmet of FIG. 7;

FIG. 11 is a top view of the helmet of FIG. 7; and,

FIG. 12 is a bottom view of the helmet of FIG. 7.

The broken lines in FIGS. 1-12 represent boundary lines and unclaimed details that form no part of the claimed design.

1 Claim, 12 Drawing Sheets

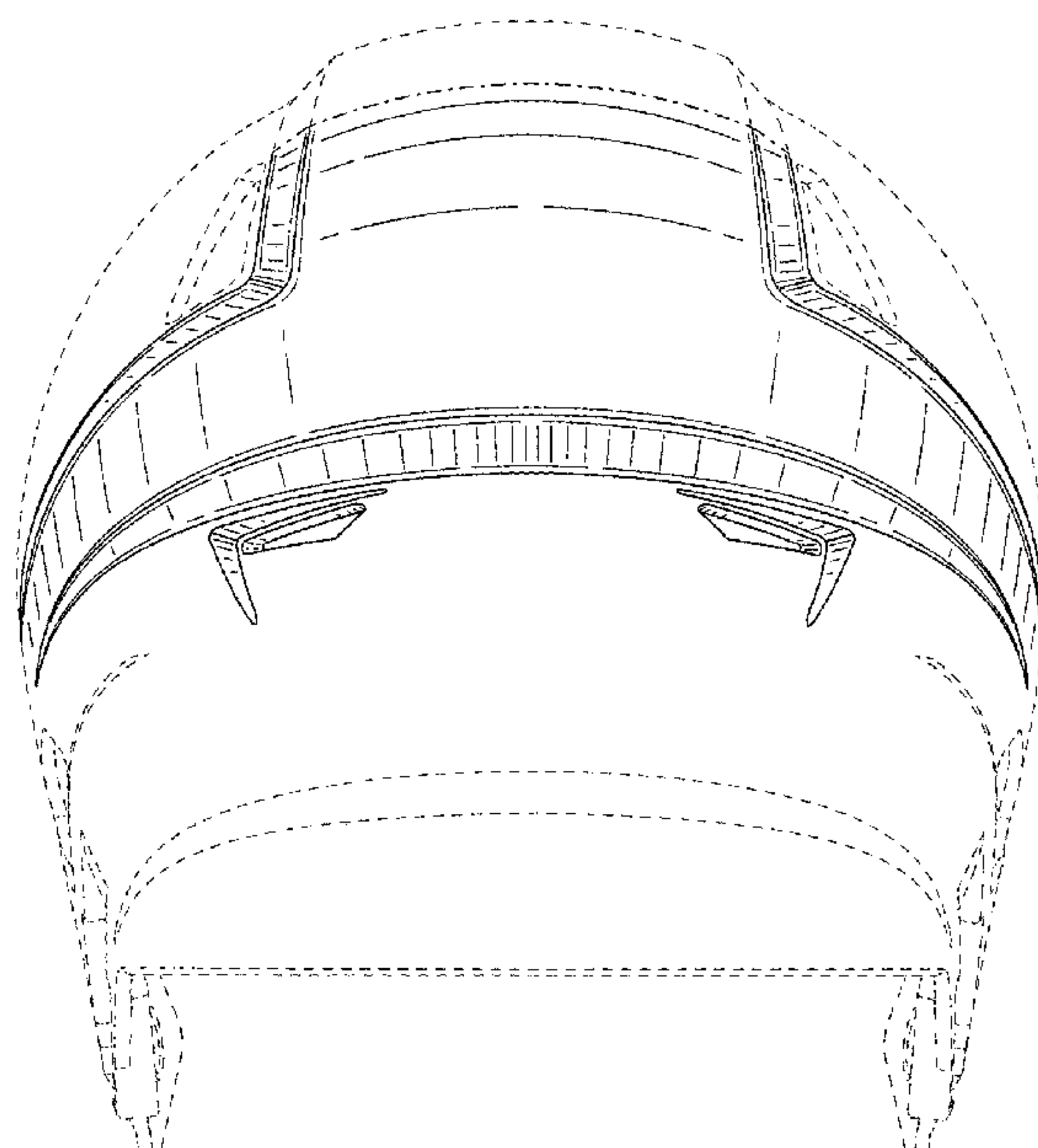
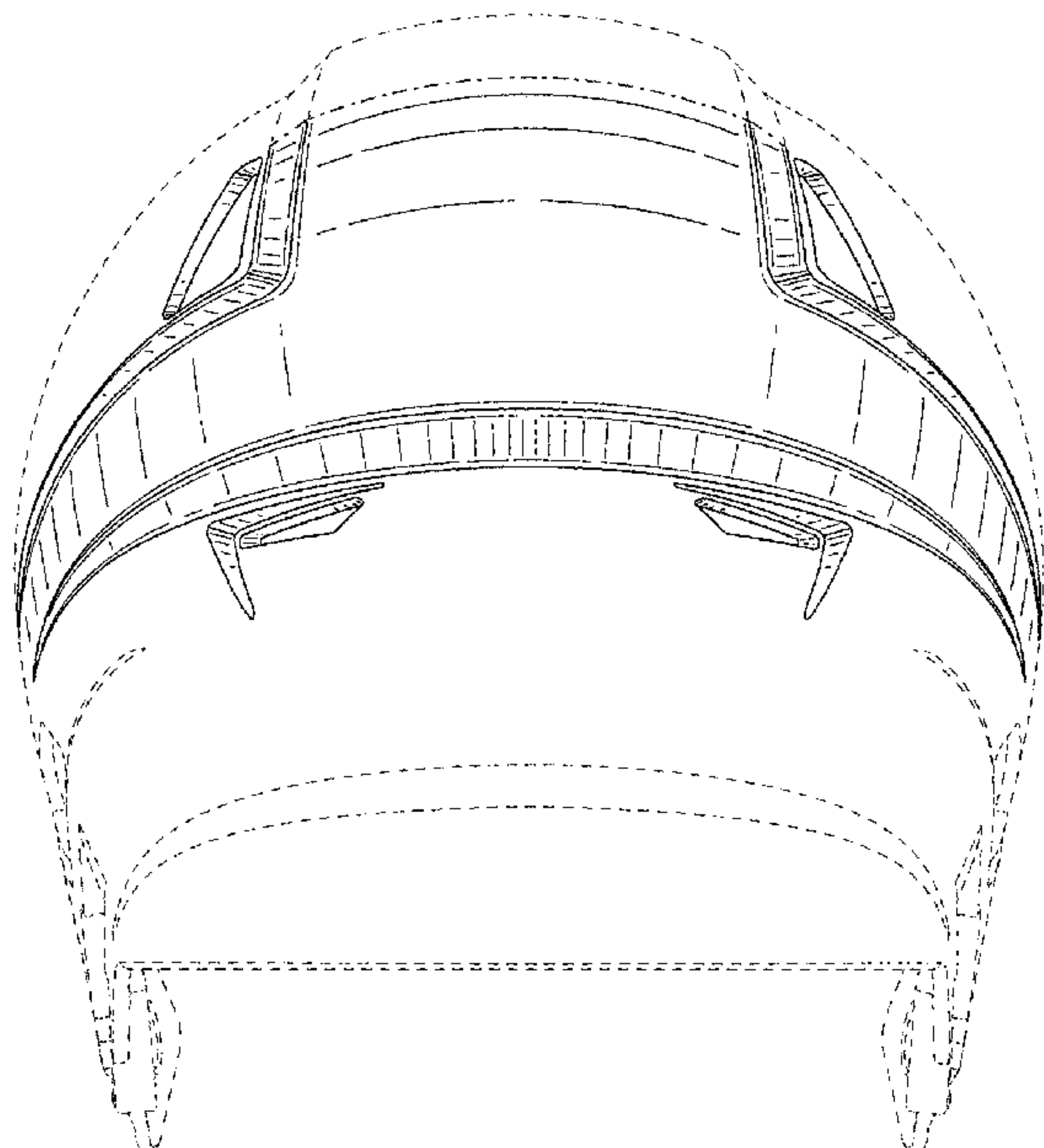

(56)

References Cited

U.S. PATENT DOCUMENTS

4,692,947 A 9/1987 Black et al.
 4,831,668 A 5/1989 Schulz
 4,853,980 A 8/1989 Zarotti
 4,947,490 A 8/1990 Hayden
 5,035,009 A 7/1991 Wingo et al.
 D332,507 S 1/1993 Anderson et al.
 5,175,889 A 1/1993 Infusino
 5,263,203 A 11/1993 Kraemer et al.
 D350,710 S 9/1994 Keiffer
 D364,487 S 11/1995 Tutton et al.
 D378,624 S 3/1997 Chartrand
 D383,953 S 9/1997 DeFilippo
 D408,236 S 4/1999 Rennick
 6,226,801 B1 5/2001 Alexander et al.
 6,321,386 B1* 11/2001 Monica 2/7
 D453,399 S 2/2002 Racine
 6,370,699 B1 4/2002 Halstead et al.
 D459,032 S 6/2002 Gatellet
 D459,554 S 6/2002 Gatellet
 6,438,762 B1 8/2002 Jenkins
 D465,067 S* 10/2002 Ide et al. D29/106
 D466,651 S 12/2002 Halstead et al.
 D475,486 S 6/2003 Ide et al.
 D495,838 S 9/2004 Arai
 D511,026 S* 10/2005 Ide et al. D29/107
 D512,534 S* 12/2005 Maddux et al. D29/106
 D528,705 S 9/2006 Ide et al.
 7,240,376 B2 7/2007 Ide et al.
 D575,458 S 8/2008 Ho

D582,607 S* 12/2008 Ferrara et al. D29/106
 D587,407 S 2/2009 Nimmons et al.
 D587,852 S* 3/2009 Nimmons D29/106
 D587,853 S* 3/2009 Nimmons D29/106
 D587,854 S* 3/2009 Nimmons et al. D29/106
 D587,855 S 3/2009 Nimmons et al.
 D603,099 S* 10/2009 Bologna et al. D29/106
 D603,100 S 10/2009 Bologna
 D616,154 S 5/2010 Daniel
 D625,050 S* 10/2010 Chen D29/106
 D629,162 S* 12/2010 Daniel D29/106
 D633,658 S 3/2011 Daniel
 7,954,177 B2 6/2011 Ide et al.
 D654,629 S 2/2012 Chou et al.
 D654,630 S 2/2012 Chou et al.
 D678,617 S* 3/2013 Erb et al. D29/106
 D681,281 S* 4/2013 Bologna et al. D29/106
 8,528,118 B2 9/2013 Ide et al.
 D696,463 S* 12/2013 Simpson D29/106
 D697,270 S* 1/2014 Simpson D29/106
 D699,895 S* 2/2014 Hill et al. D29/102
 D718,002 S* 11/2014 Littrell, Jr. D29/106
 2004/0025231 A1* 2/2004 Ide et al. 2/425
 2009/0106882 A1* 4/2009 Nimmons et al. 2/414
 2009/0265841 A1 10/2009 Ferrara
 2010/0005573 A1 1/2010 Rudd et al.
 2011/0209272 A1 9/2011 Drake
 2012/0011639 A1 1/2012 Beauchamp et al.
 2012/0079646 A1 4/2012 Belanger et al.
 2014/0115759 A1* 5/2014 Tomlin et al. 2/411
 2014/0223643 A1* 8/2014 Infusino et al. 2/413
 2014/0223646 A1* 8/2014 Bologna et al. 2/424

* cited by examiner

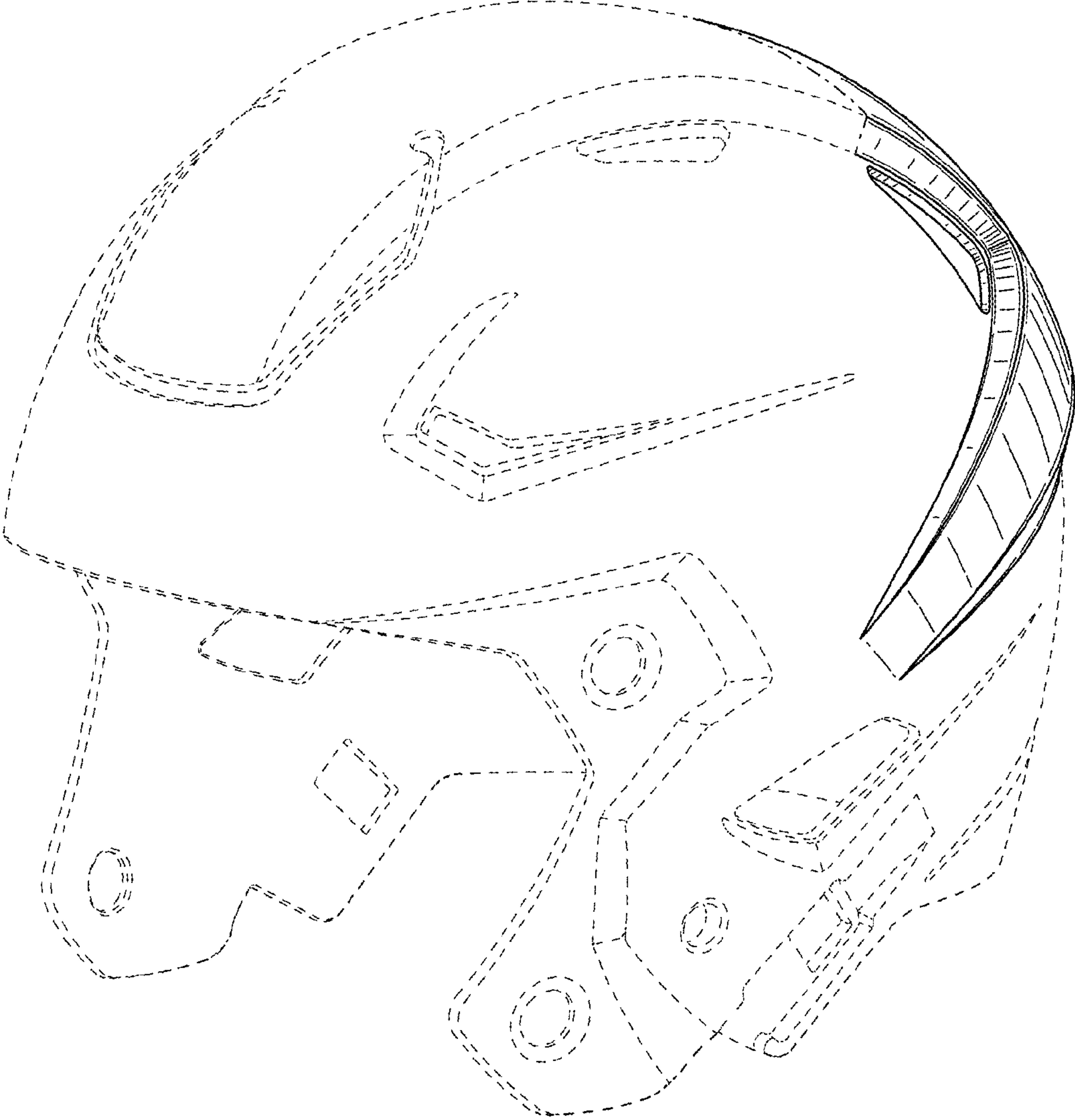

FIG. 1

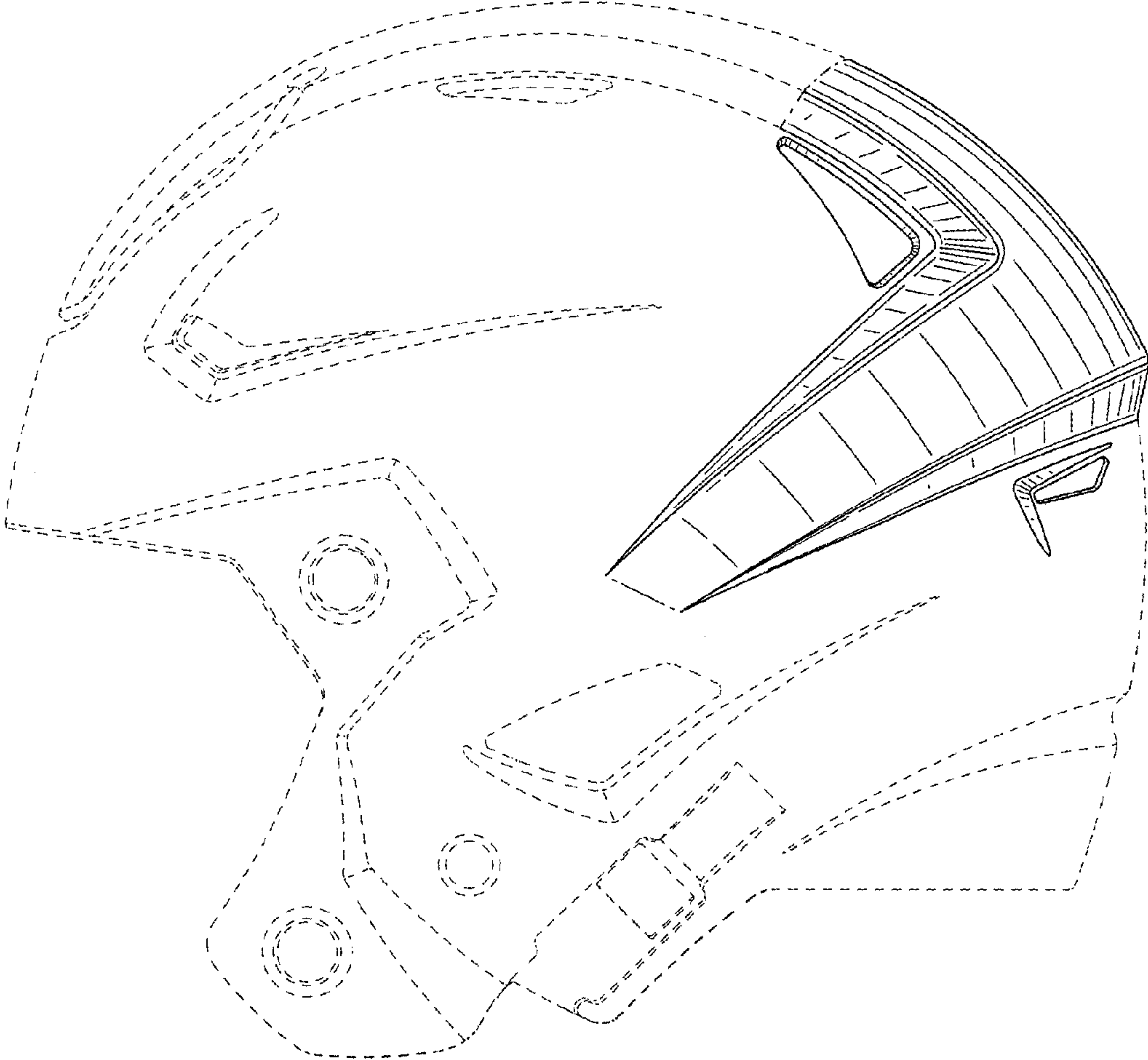

FIG. 2

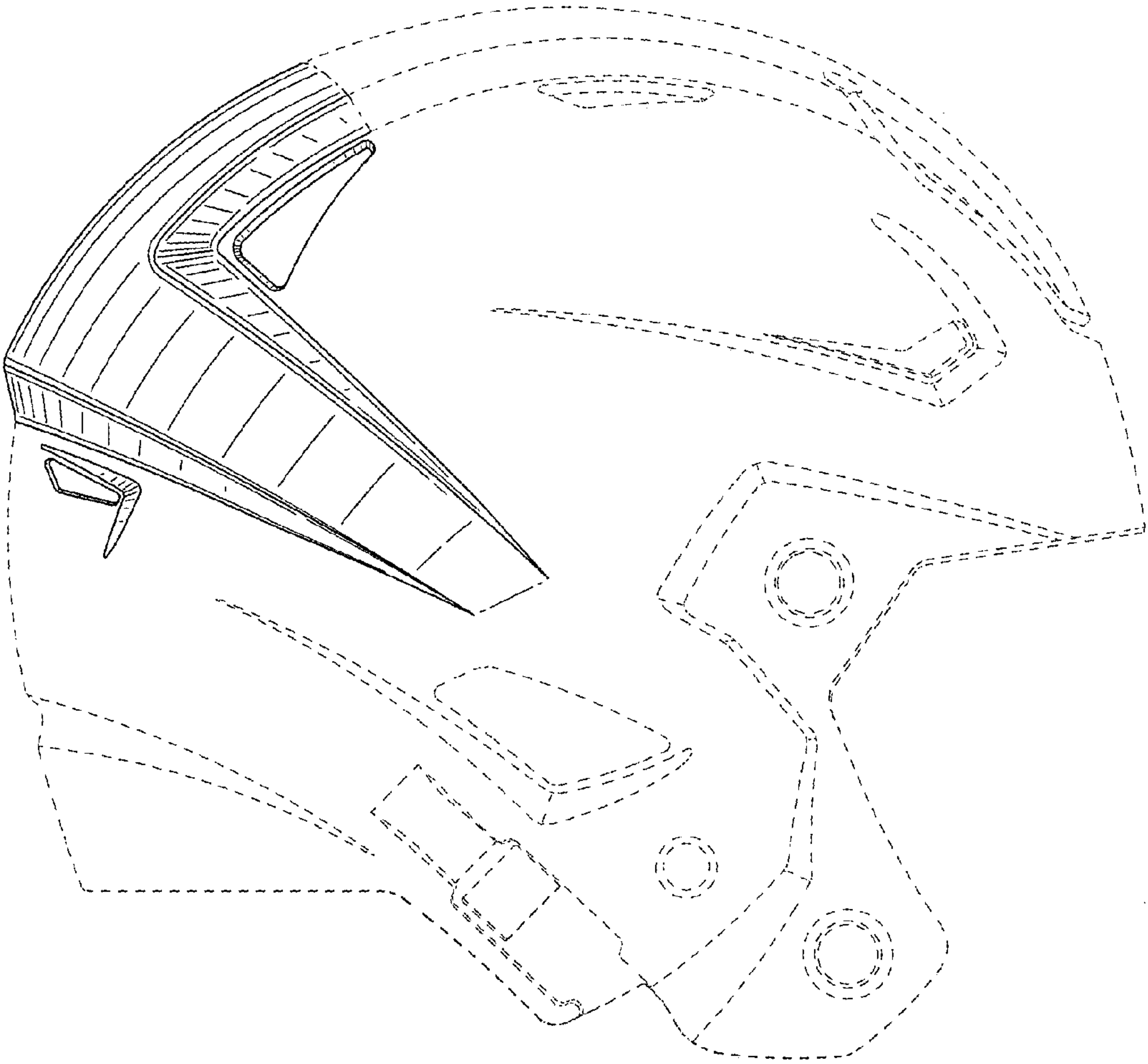

FIG. 3

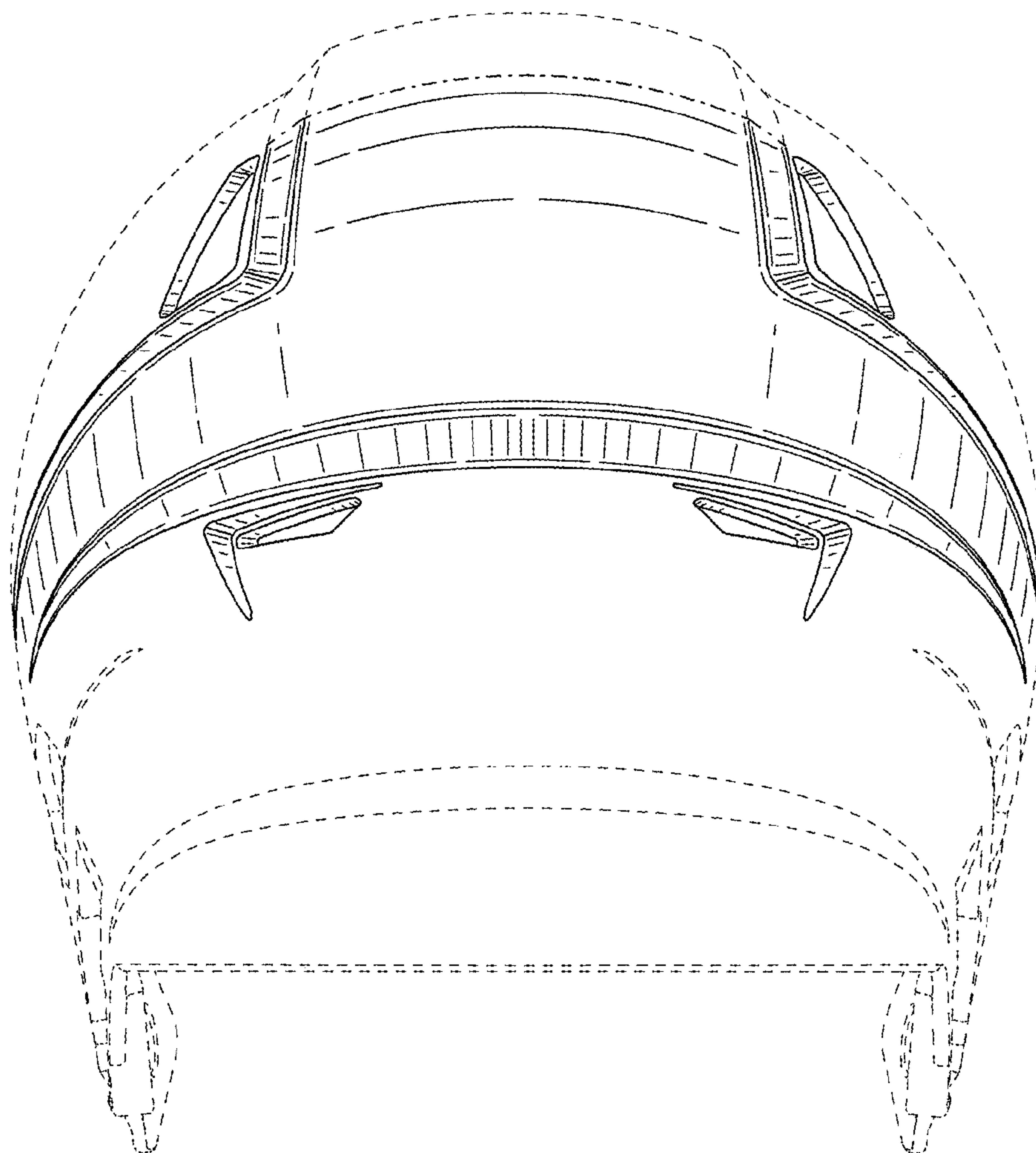

FIG. 4

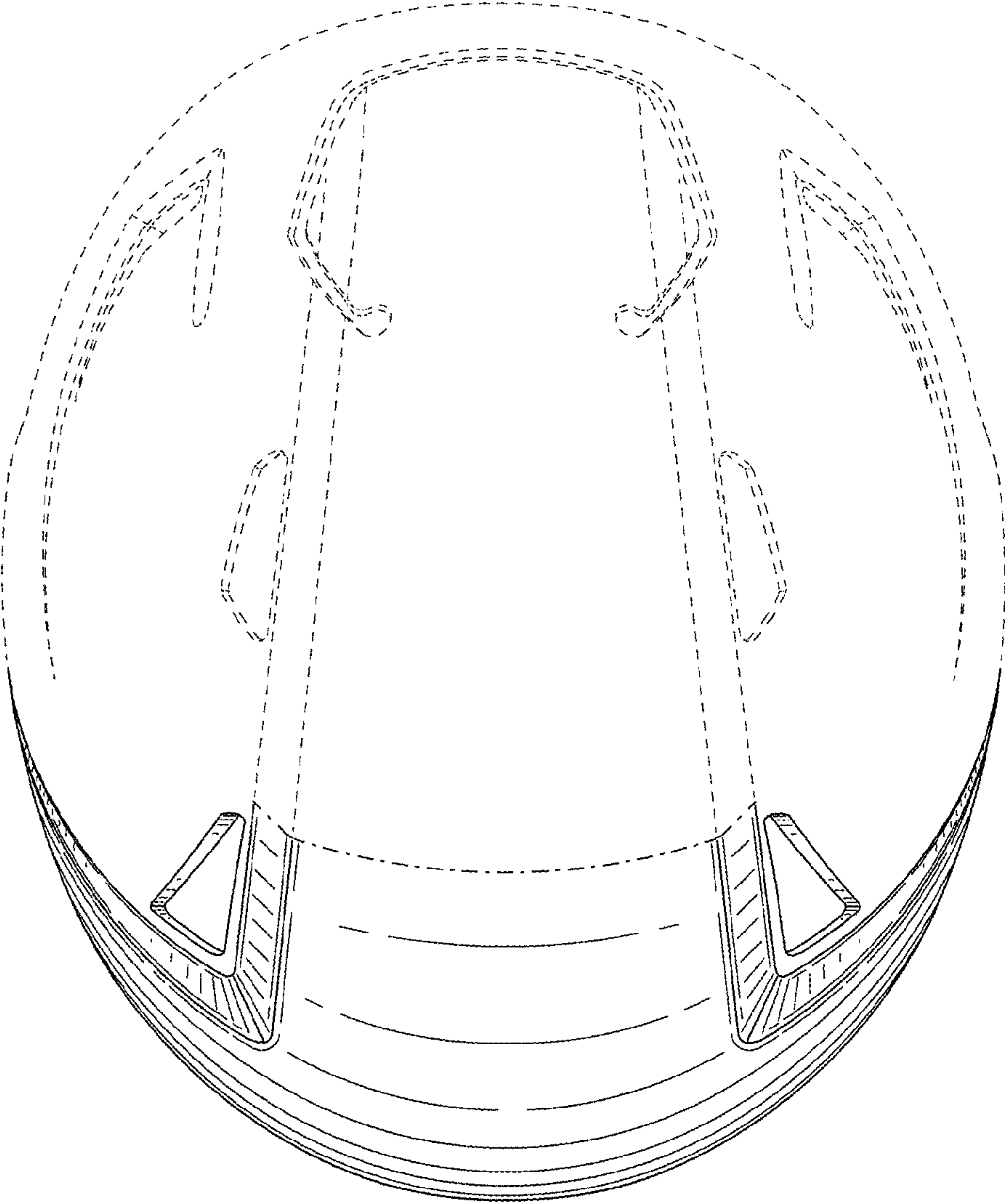

FIG. 5

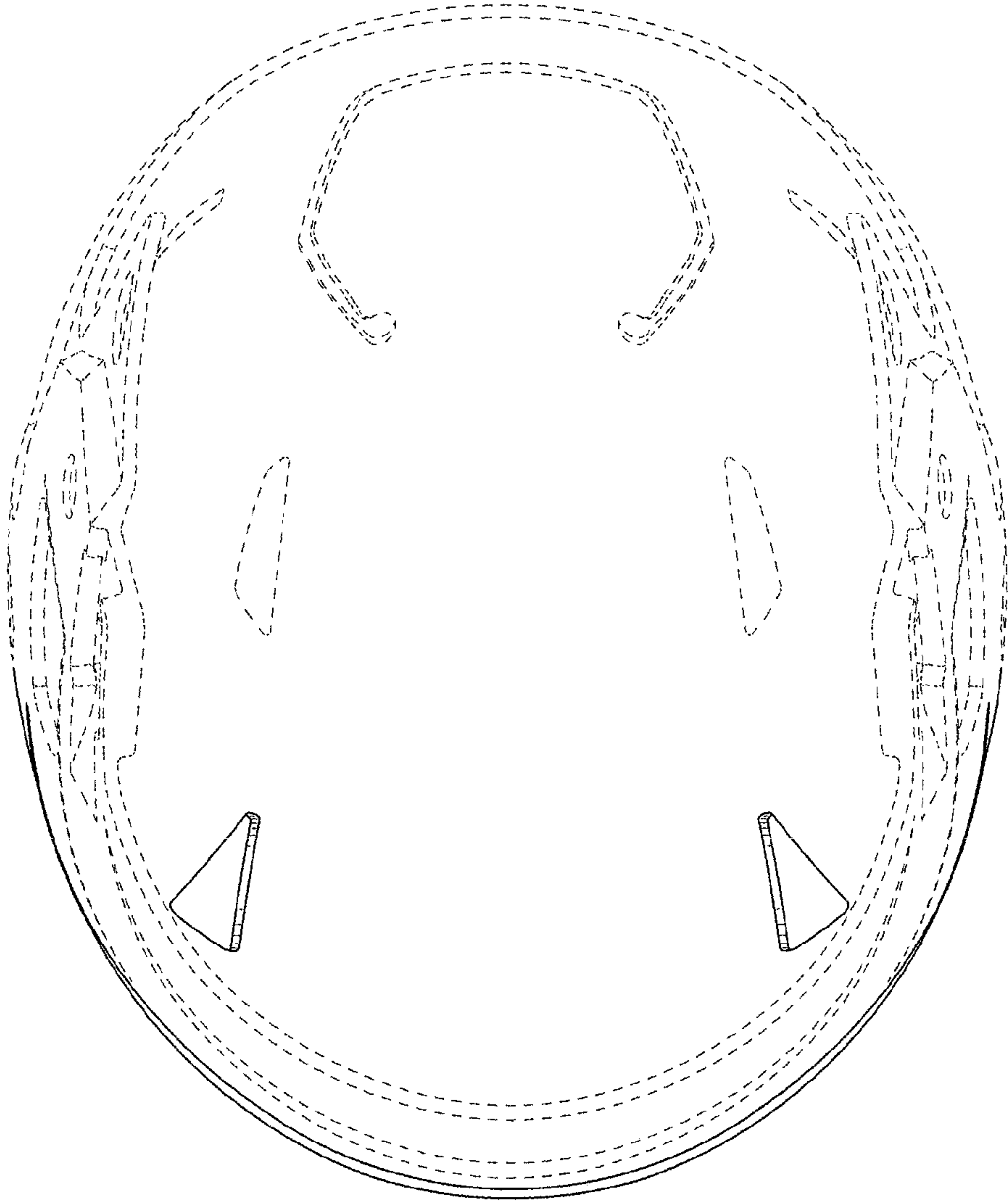

FIG. 6

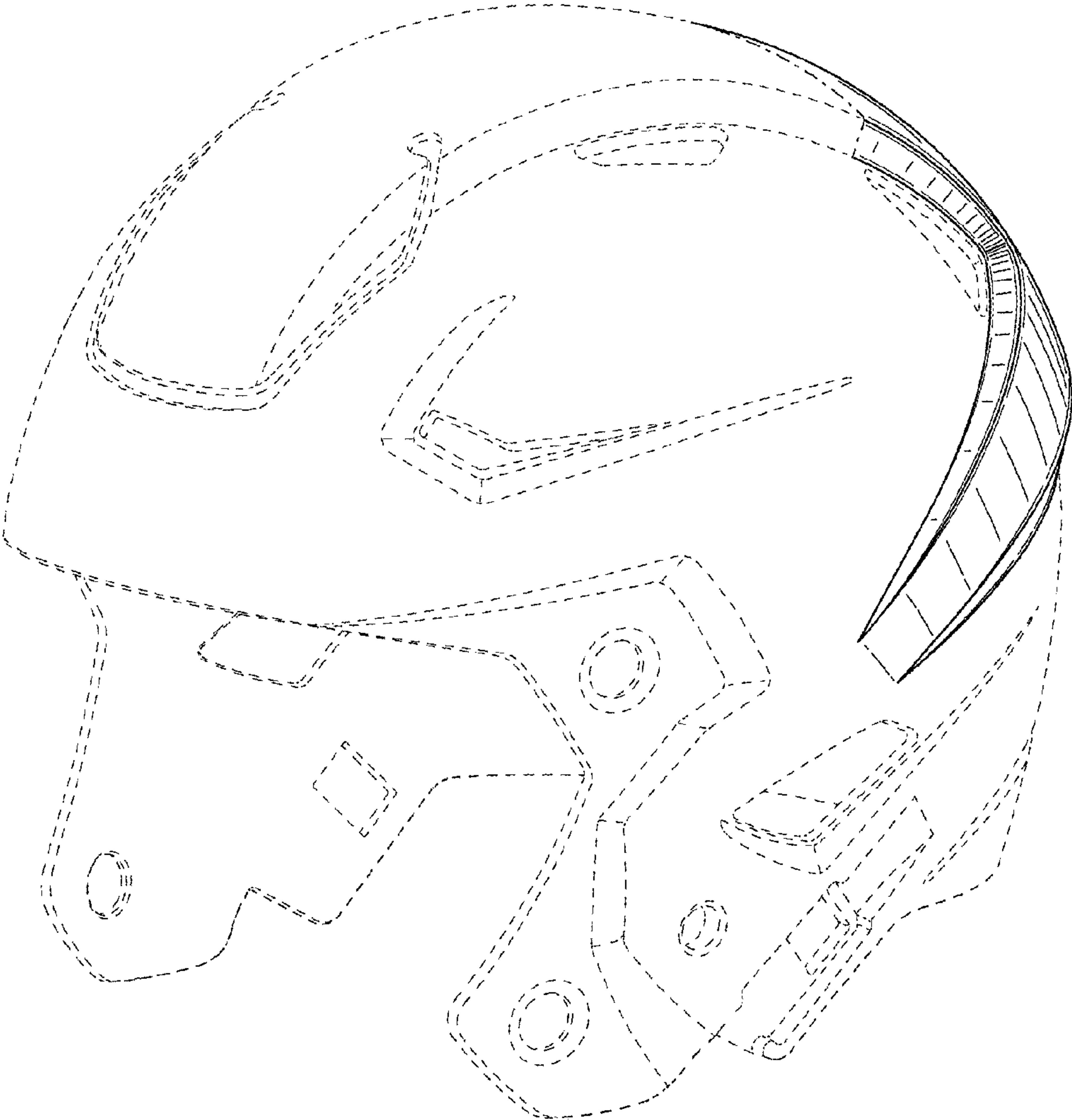

FIG. 7

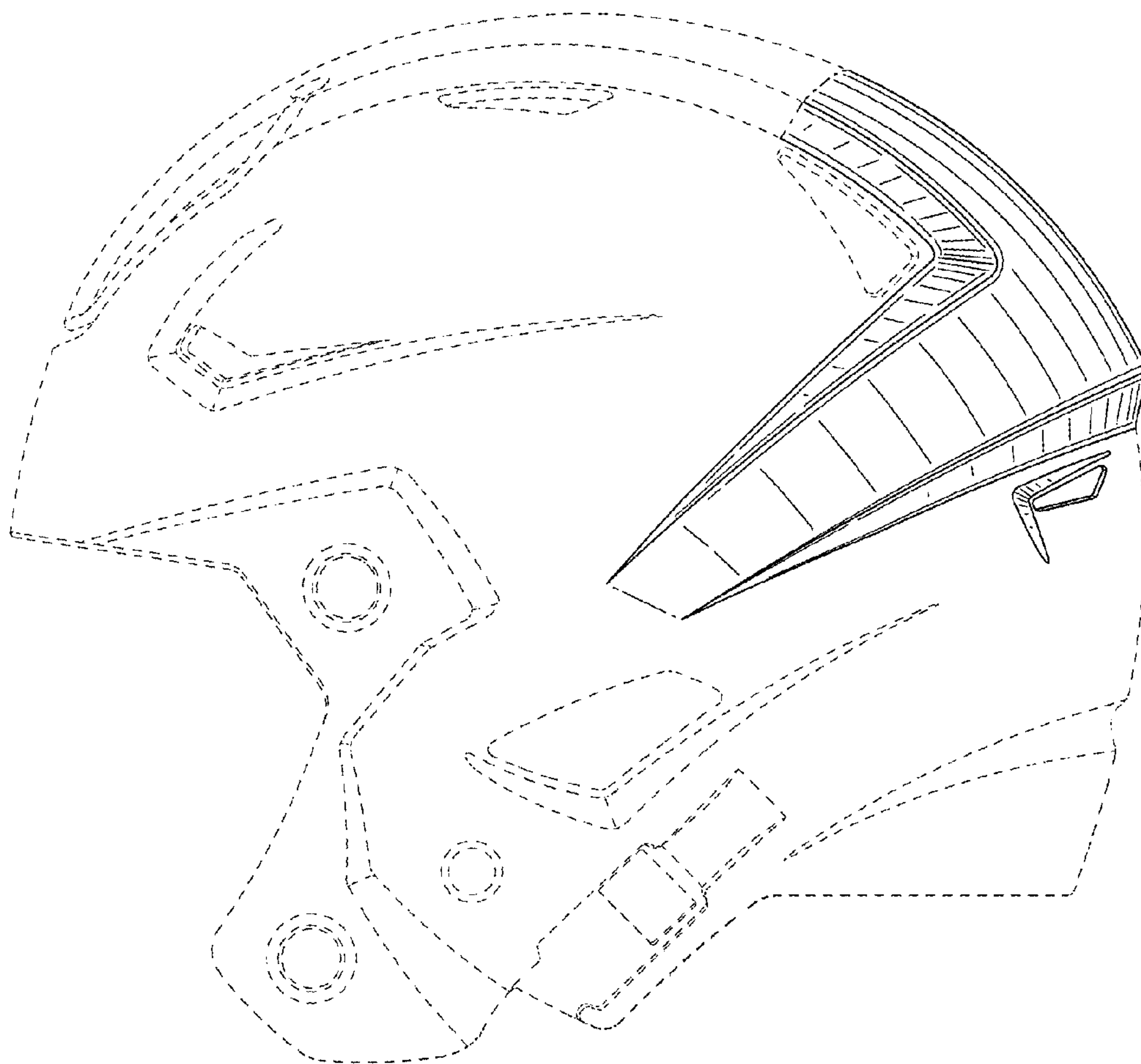

FIG. 8

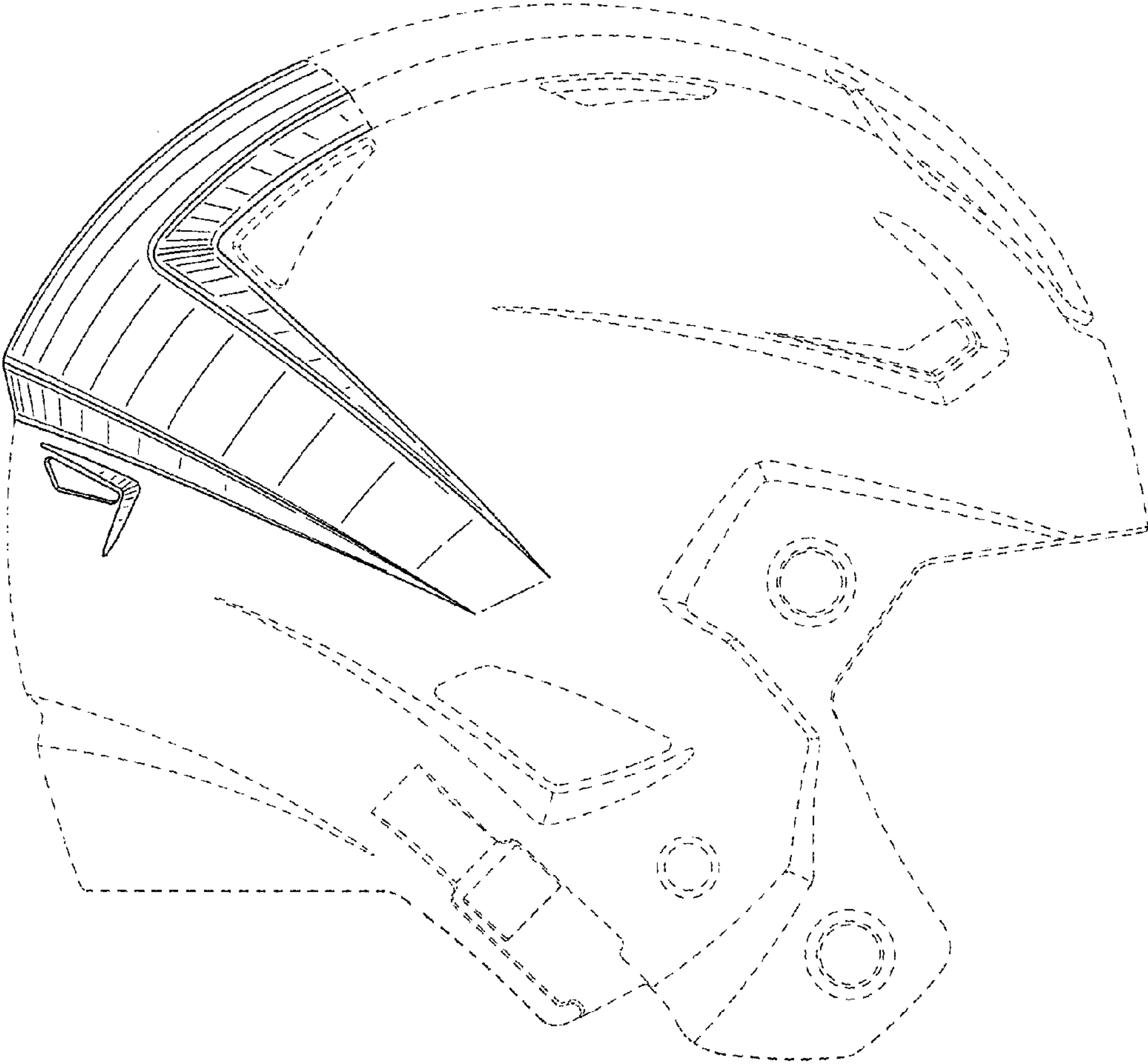

FIG. 9

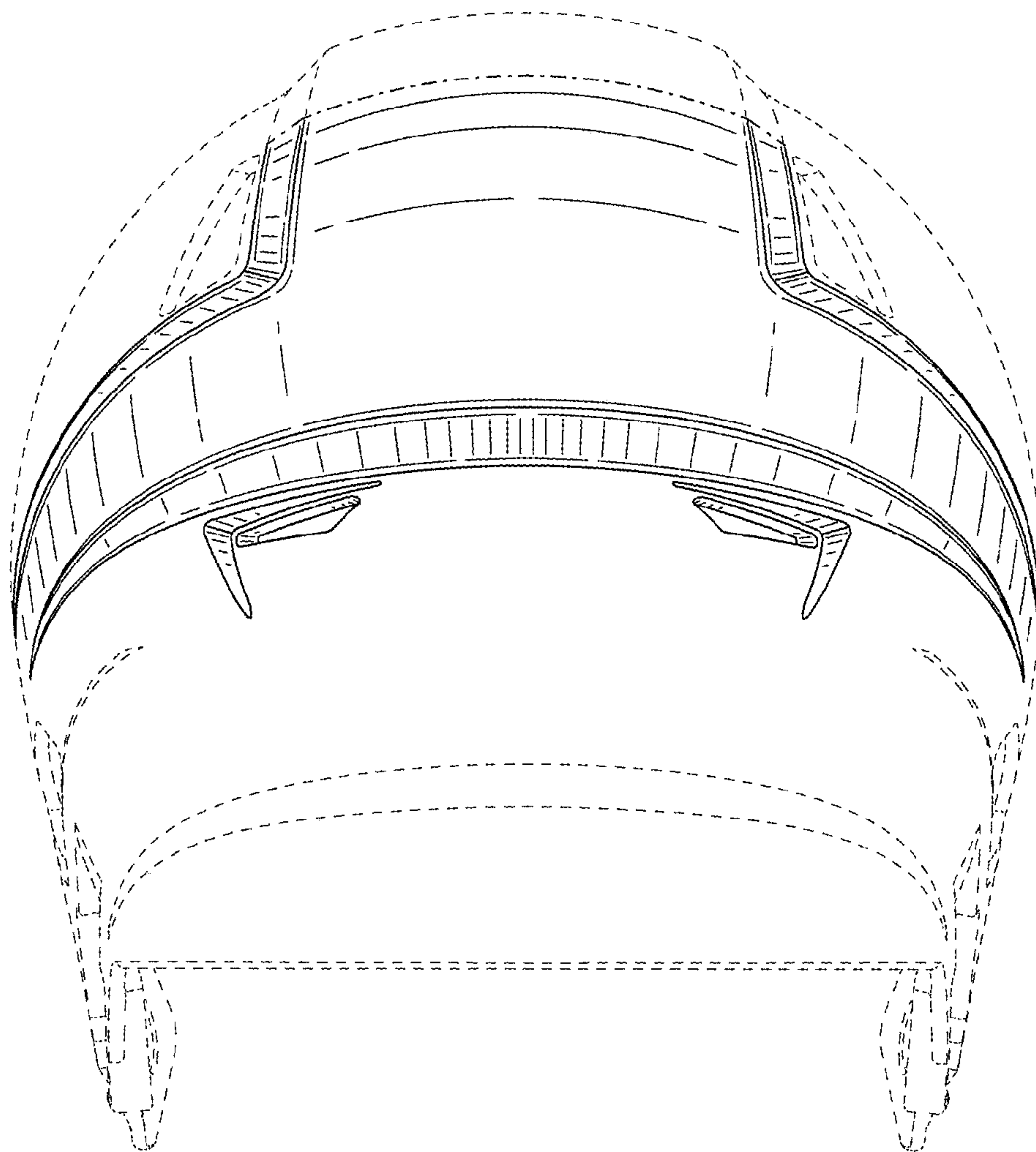

FIG. 10

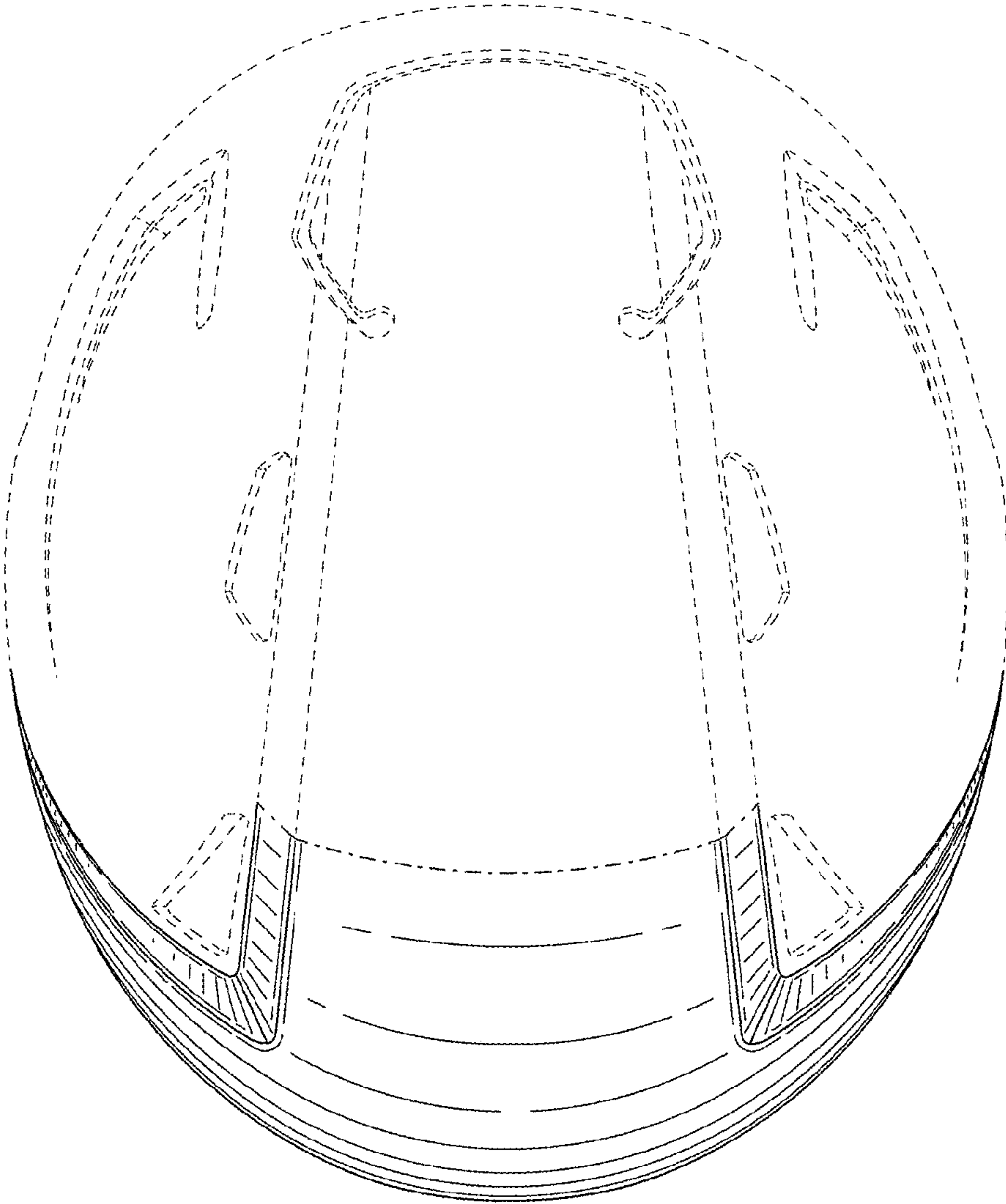

FIG. 11

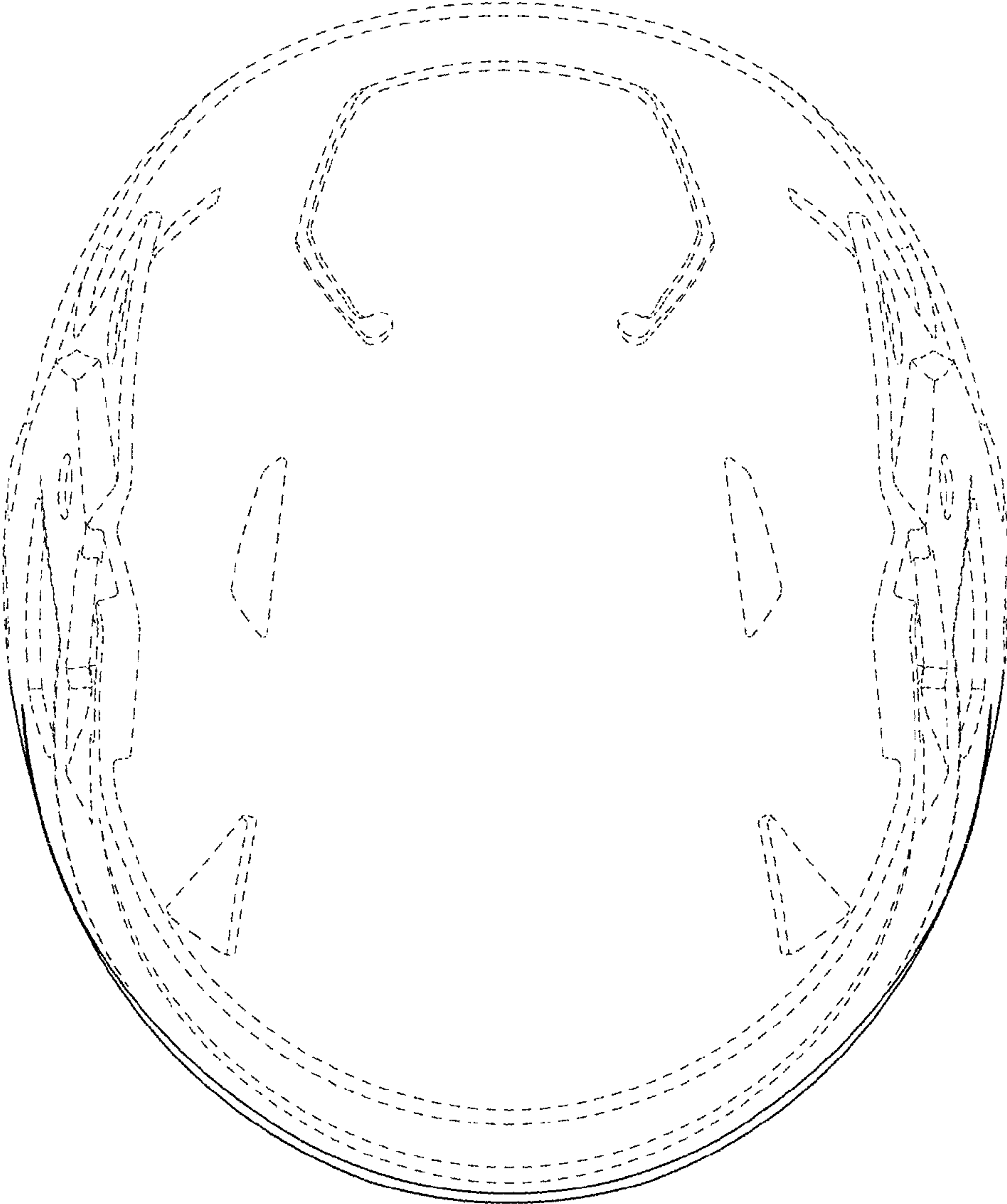

FIG. 12